

| REVISIONS | | | | |
|-----------|-----------|---------------------------|----|------|
| REV | DATE | DESCRIPTION | BY | CHKD |
| D | 20NOV2013 | REVISED PER ECO-13-018116 | KH | JO |
| E | 23AUG2022 | REVISED PER ECR-22-137476 | RK | SD |
| E1 | 04AUG2023 | REVISED PER ECN-23-224702 | RK | MF |

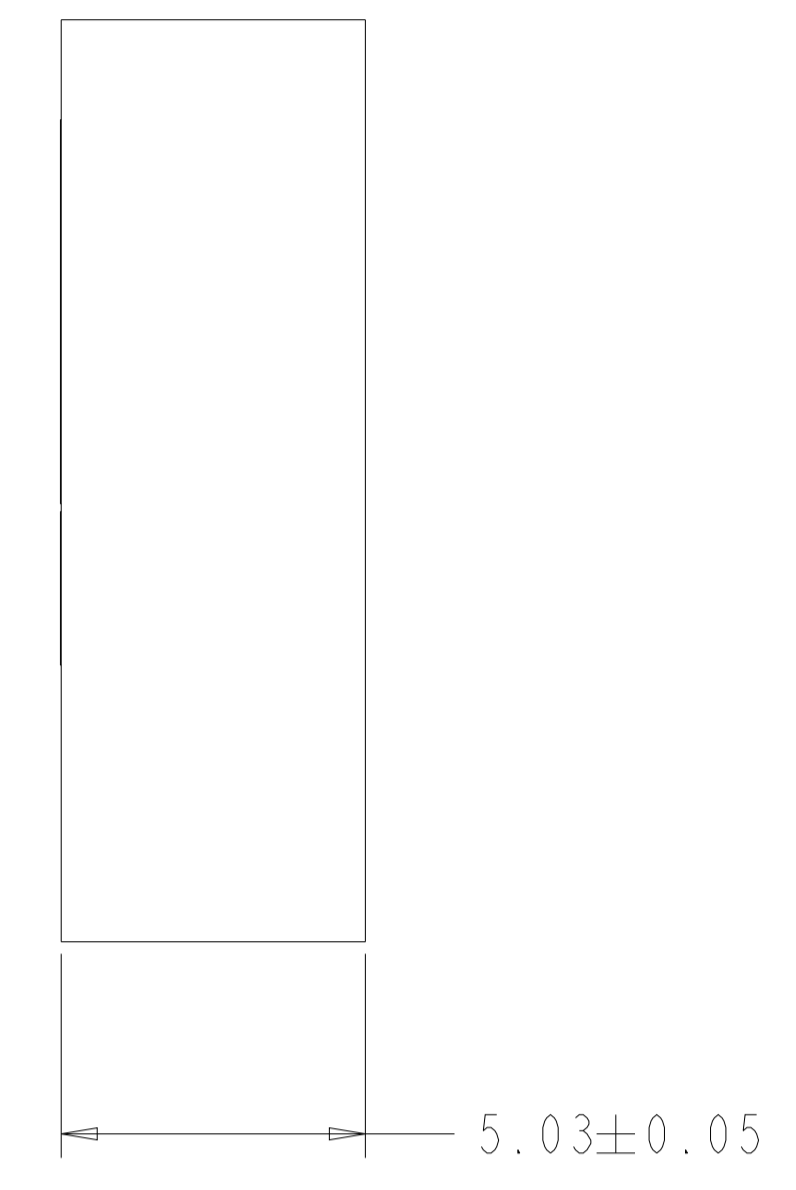

- 1 GLASS FILLED THERMOPLASTIC, UL 94-V0 RATED, COLOR:BLACK
- 2 EJECTOR FEATURES AT MOLDER'S DISCRETION (QUANTITY AND LOCATION).
- 3 THE PRODUCT IS IN PROCESS FOR UL RECOGNITION.
- 4 THE PRODUCT IS NOT YET QUALIFIED AND IS IN PROCESS.

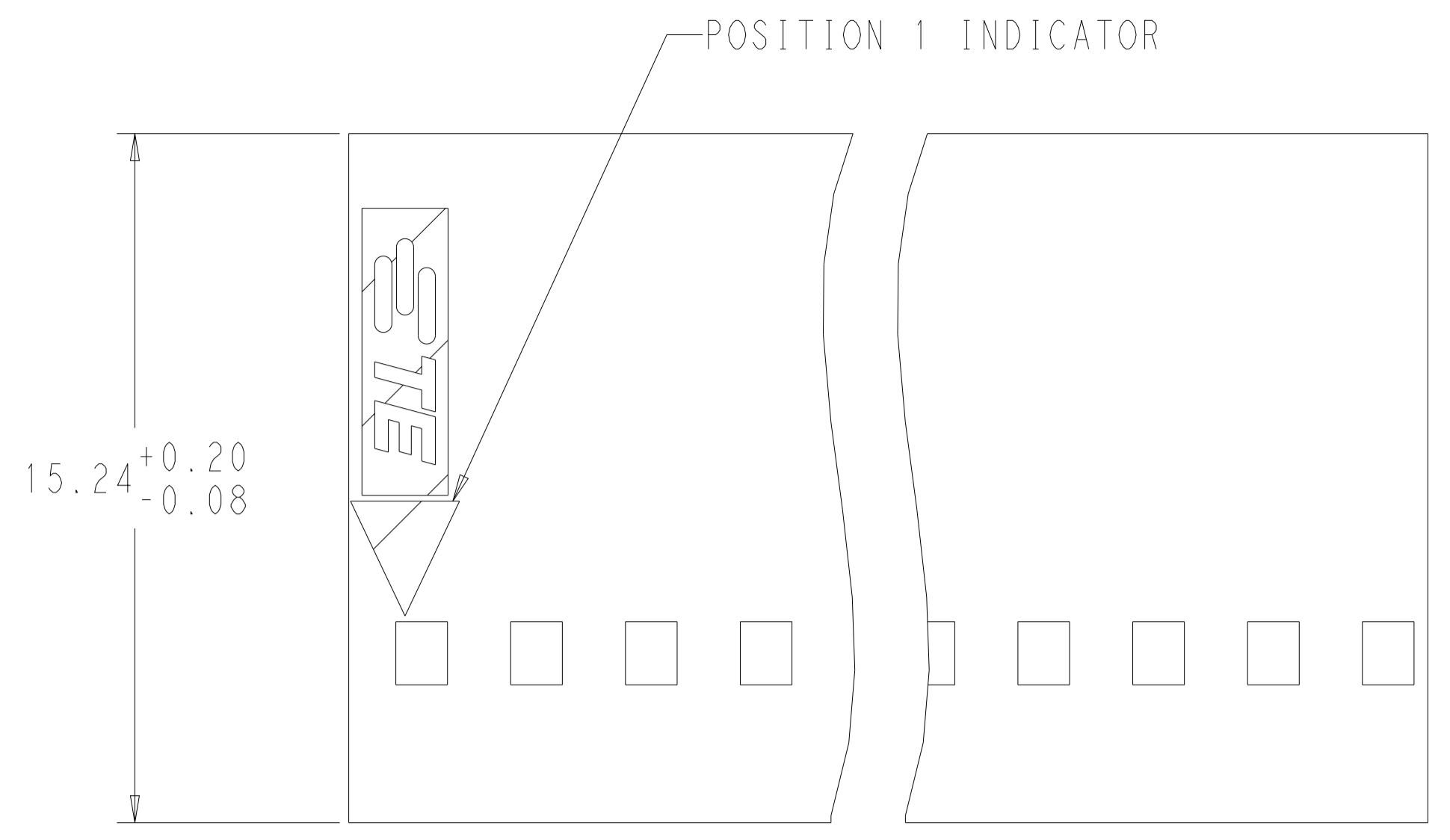
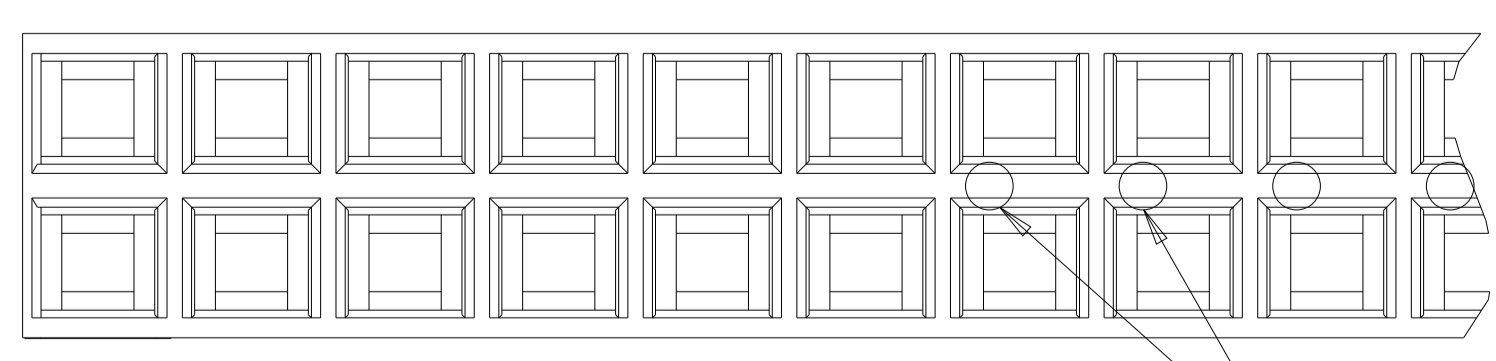
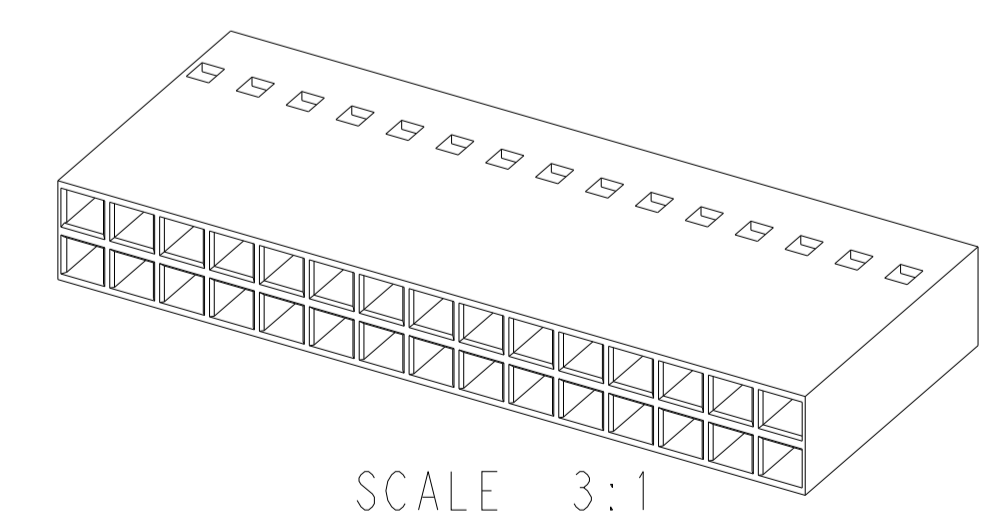
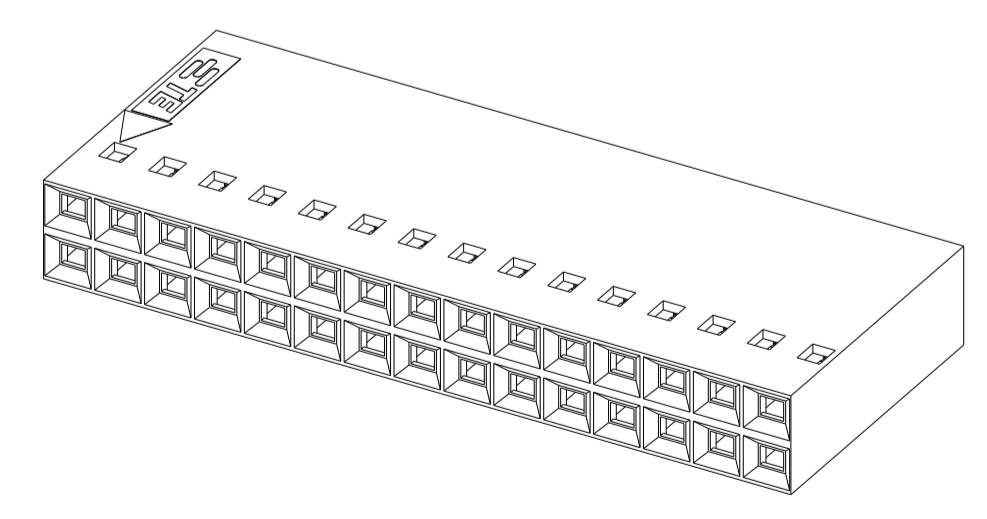
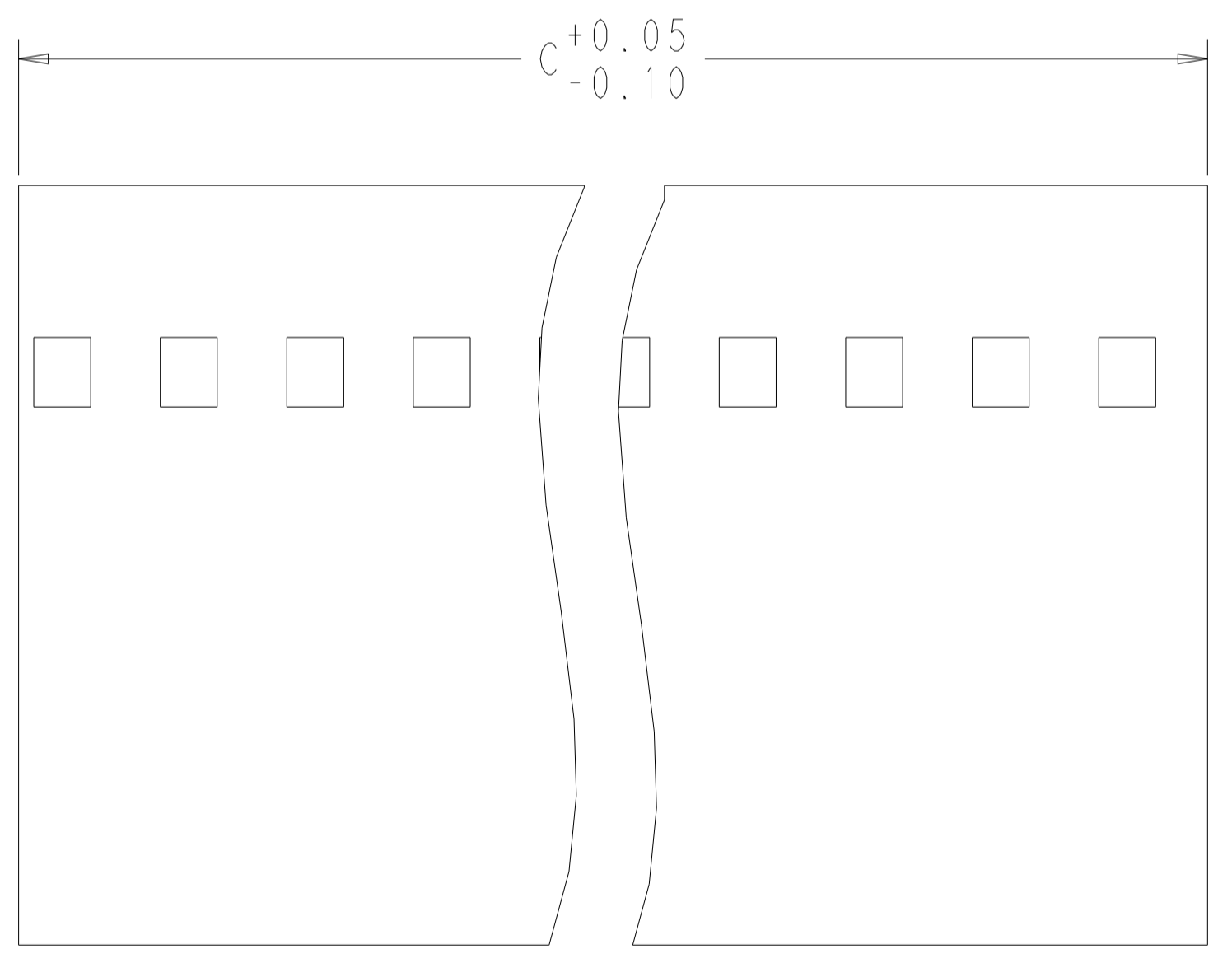
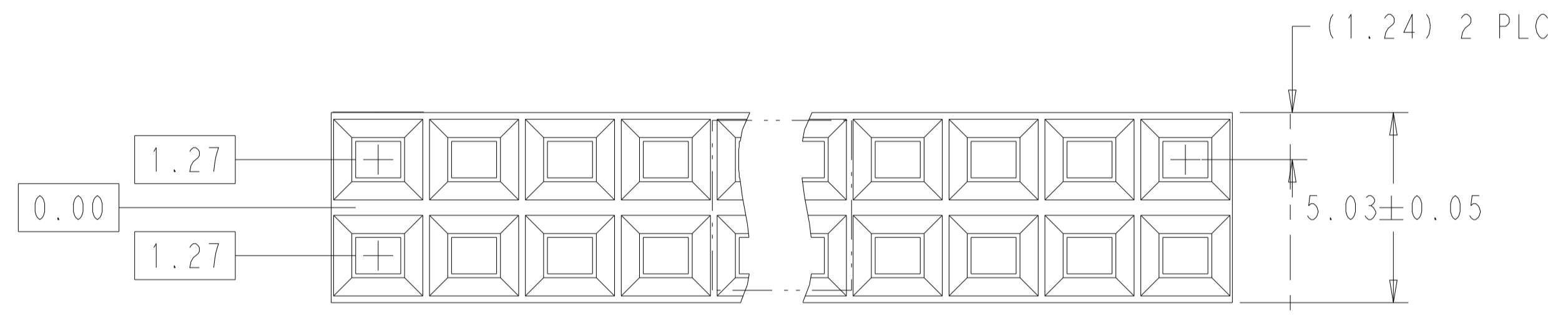

REAR VIEW OF CONNECTOR

| DIM "C" | NO OF SP | NO OF POSN | PART NUMBER |
|---------|----------|------------|-------------|
| 65.99 | 25 | 52 | 2-104482-0 |
| 55.83 | 21 | 44 | 1-104482-9 |
| 50.75 | 19 | 40 | 1-104482-8 |
| 48.21 | 18 | 38 | 1-104482-7 |
| 45.67 | 17 | 36 | 1-104482-6 |
| 43.13 | 16 | 34 | 1-104482-5 |
| 40.59 | 15 | 32 | 1-104482-4 |
| 38.05 | 14 | 30 | 1-104482-3 |
| 35.51 | 13 | 28 | 1-104482-2 |
| 32.97 | 12 | 26 | 1-104482-1 |
| 27.89 | 10 | 22 | 1-104482-0 |
| 25.35 | 9 | 20 | 104482-9 |
| 22.81 | 8 | 18 | 104482-8 |
| 20.27 | 7 | 16 | 104482-7 |
| 17.73 | 6 | 14 | 104482-6 |
| 15.19 | 5 | 12 | 104482-5 |
| 12.65 | 4 | 10 | 104482-4 |
| 10.11 | 3 | 8 | 104482-3 |
| 7.57 | 2 | 6 | 104482-2 |
| 5.03 | 1 | 4 | 104482-1 |

THIS DRAWING IS A CONTROLLED DOCUMENT.

DWN: SCOTT A. SHUEY 17MAY89
 CHK: H. MOLL 18MAY89

APVD: H. ELICKER 18MAY89

TE Connectivity

NAME: RCPT HSG, DBL ROW, 2.54x2.54 CL SHORT PT, AMPMODU

SIZE: A1 CAGE CODE: 00779 DRAWING NO: 104482

SCALE: 8:1 SHEET 1 OF 1 REV: E1