

THIS DRAWING IS UNPUBLISHED. RELEASED FOR PUBLICATION
 © COPYRIGHT - BY TYCO ELECTRONICS CORPORATION. ALL RIGHTS RESERVED.

LOC	DIST	REVISIONS					
G	14	P	LTR	DESCRIPTION	DATE	DWN	APVD
			02	REV PER ECR 07-020486	28AUG07	JR	TM

AMP
WIRE RANGE

22 AWG
SOLID OR STRANDED

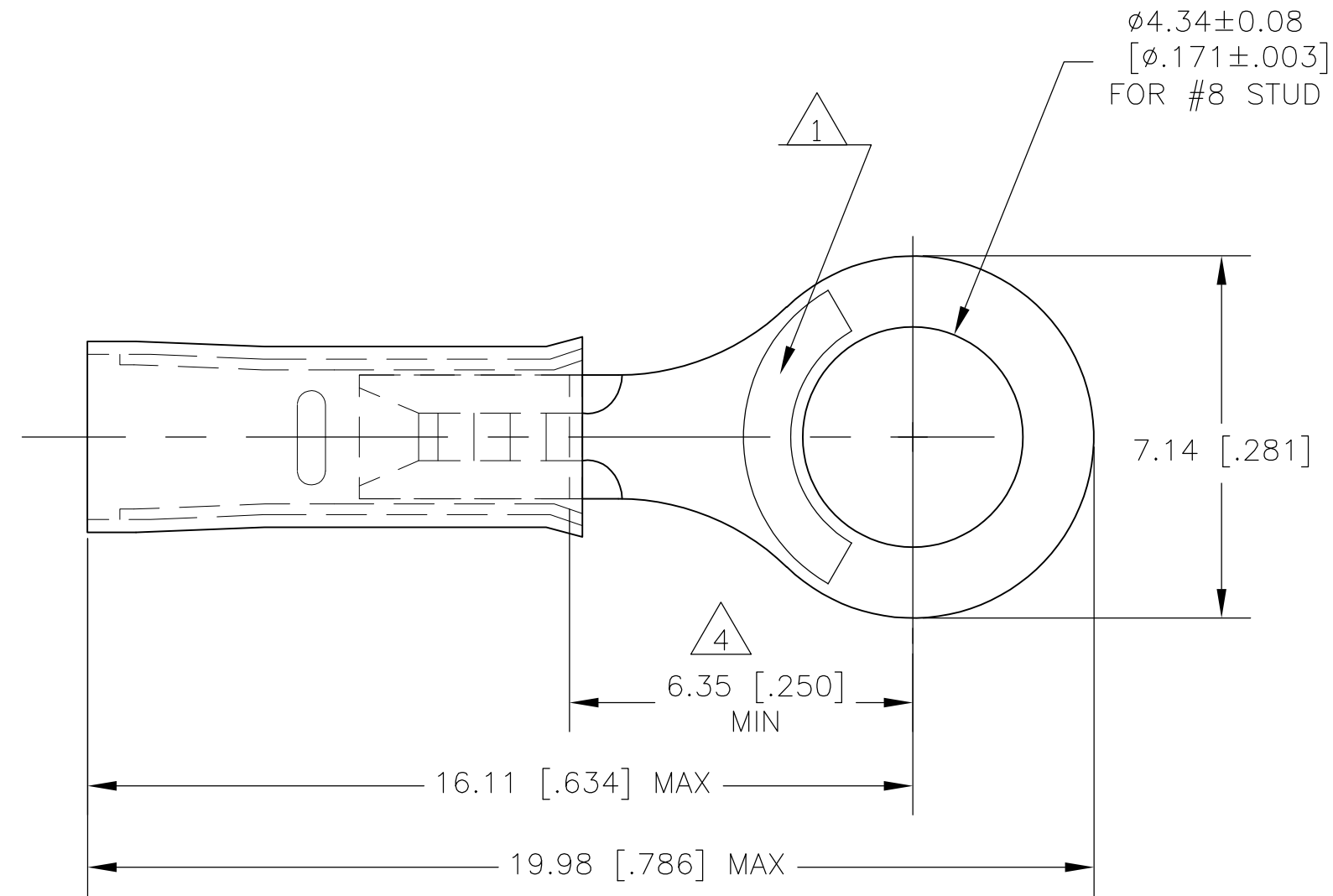

- 1 STAMP AMP 22, LOCATE APPROX AS SHOWN.
- 2 WIRE INSULATION DIA IS 0.9-2.5 [.035-.100]
- 3 TONGUE MATERIAL THK IS 0.79±0.05 [.031±.002]
- 4 DIMENSION APPLIES FROM EDGE OF METAL WIRE BARREL TO CENTER OF STUD HOLE.
- 5 MATERIAL: BODY-COPPER PER ASTM B-152
SLEEVE-NYLON, BLACK
- 6 FINISH: BODY-TIN PLATE PER ASTM B-545
- 7 MAX RECOMMENDED OPERATING 105°C
- 8 VOLTAGE RATING 300V MAX
- 9 CIRCULAR MIL AREA 0.26-0.41mm² [509-810] CMA.

500	LOOSE PIECE	151440
QTY	PACKAGE TYPE	PART NO

THIS DRAWING IS A CONTROLLED DOCUMENT.		DWN jr_ruth 09MAY06	Tyco Electronics Corporation Harrisburg, PA 17105-3608	
DIMENSIONS: INCHES		CHK T MICHELUTTI 09MAY06	NAME TERMINAL, RING TONGUE, PIDG, WIRE SIZE: 22 AWG	
TOLERANCES UNLESS OTHERWISE SPECIFIED:		APVD T MICHELUTTI 09MAY06	PRODUCT SPEC	
0 PLC ± - 1 PLC ± - 2 PLC ± - 3 PLC ± .005 4 PLC ± - ANGLES ± 5°		APPLICATION SPEC		
MATERIAL	FINISH	WEIGHT	SIZE A3	CAGE CODE 00779
- 5	- 6	-	DRAWING NO G-151440	RESTRICTED TO
CUSTOMER DRAWING			SCALE 8:1	SHEET 1 OF 1
			REV 02	