

P	LTR	DESCRIPTION	DATE	DWN	APVD
0		PRELIMINARY ISSUE	04MAY2001	M.B.	O.C.
A		FIRST ISSUE (ET00-046-02)	07MAR2002	M.B.	O.C.
A1		RELEASED FOR PRODUCTION (ET00-0235-04)	10DEC2004	M.B.	O.C.
A2		UPDATED PARTS TABLE (ECR-06-000726)	16JAN2006	M.P.	O.C.

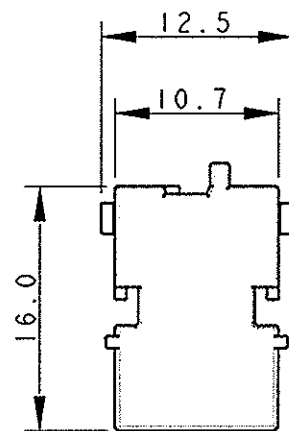
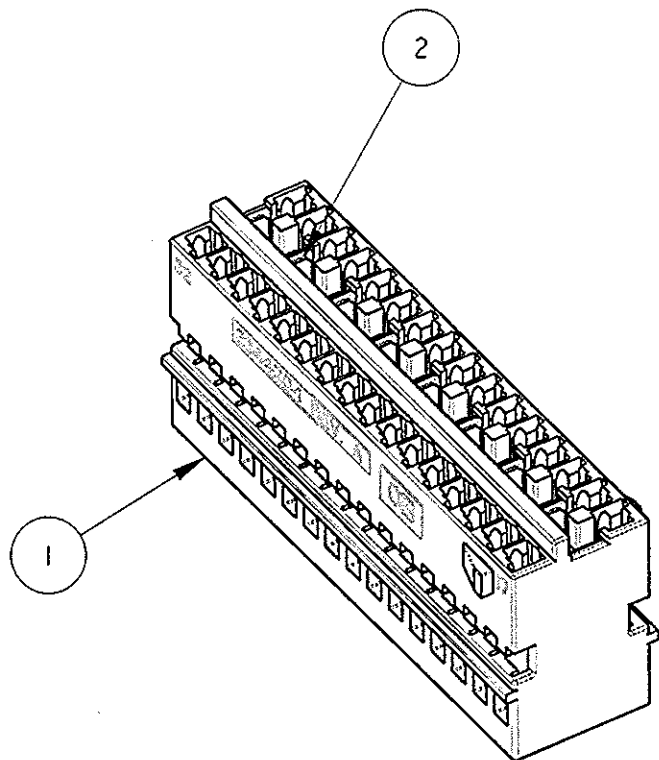

NOTES
(NOTE)

1) HOUSING SUITABLE FOR SHELL P/N 284715-1
(BLOCCHETTO ADATTO PER LA CORAZZA P/N 284715-1)

2) N. 32 CAVITIES SUITABLE FOR FEMALE CONNECTORS MQS P/N 144969-2
CuNiSi + STAINLESS STEEL SPRING GOLD PLATED ON CONTACT AREA
AND IN THE BACK OF THE SPRING
WIRE SIZE 0.35-0.5 mm2
(CAVITA' ADATTE PER CONTATTI FEMMINA MQS P.N. 144969-2
CuNiSi + MOLLA ACCIAIO INOX DORATA NELLA ZONA DI CONTATTO
E SUL DORSO DELLA MOLLA
RANGO FILO 0.35-0.5 mm2)

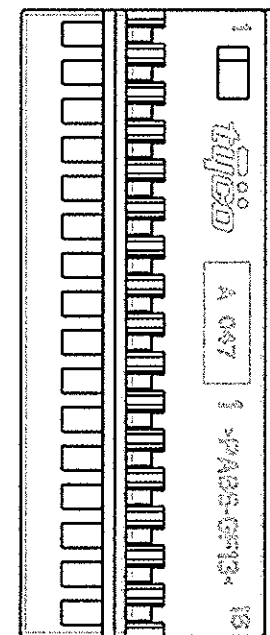
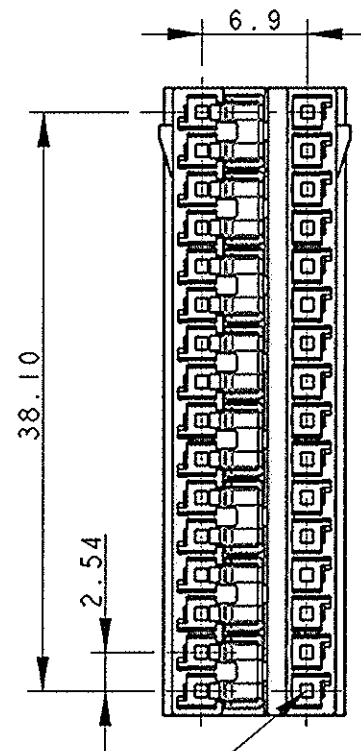
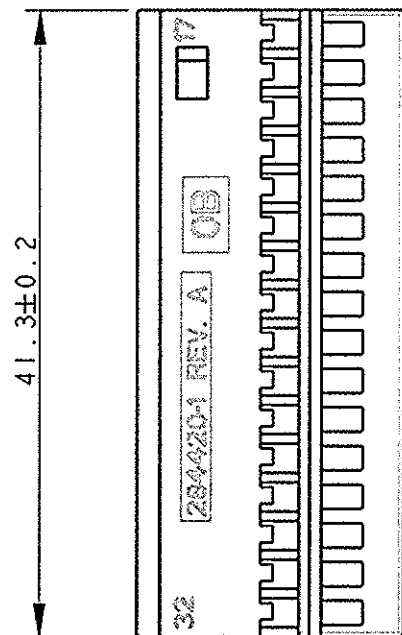

ITEM (VOCE)	DESCRIPTION (DESCRIZIONE)	MATERIAL (MATERIALE)	Q. TY (Q. TA')
1	HOUSING (BLOCCHETTO)	PA 66 GF COLOR BLACK (COLORE NERO)	1
2	SHORT CIRCUIT SPRING (MOLLA DI CORTO CIRCUITO)	STAINLESS STEEL (ACCIAIO INOX)	8

284422-1 AS SHOWN
(COME MOSTRATO)

<small>THIS DRAWING IS A CONTROLLED DOCUMENT FOR TYCO ELECTRONICS CORPORATION IT IS SUBJECT TO CHANGE AND THE CONTROLLING ENGINEERING ORGANIZATION SHOULD BE CONTACTED FOR THE LATEST REVISION.</small>		DWN M. BARBERIS 04MAY2001 CHK O. CANUTO 04MAY2001 APVD A. GENTA PRODUCT SPEC APPLICATION SPEC WEIGHT -	tyco Electronics tyco Electronics AMP Italia S.p.A. C.so F.lli Cervi, 15 Collegno (TO)
DIMENSIONS: mm 	TOLERANCES UNLESS OTHERWISE SPECIFIED: 0 PLC ±0.3 1 PLC ±0.2 2 PLC ±0.1 3 PLC ± 4 PLC ± ANGLES ±1°	NAME 32 POSITIONS REC. HOUSING ASS'Y FOR AIRBAG SIZE A3 CAGE CODE 00779 DRAWING NO C-284422	RESTRICTED TO -
MATERIAL SEE TABLE (VEDI TABELLA)	FINISH SEE TABLE (VEDI TABELLA)	CUSTOMER DRAWING	SCALE 2:1 SHEET 1 OF 3 REV A2

LOC	DIST	REVISIONS					
		P	LTR	DESCRIPTION	DATE	DWN	APVD
1	-	-	-	SEE SHEET 1 (VEDI FOGLIO 1)	-	-	-

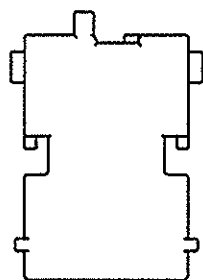
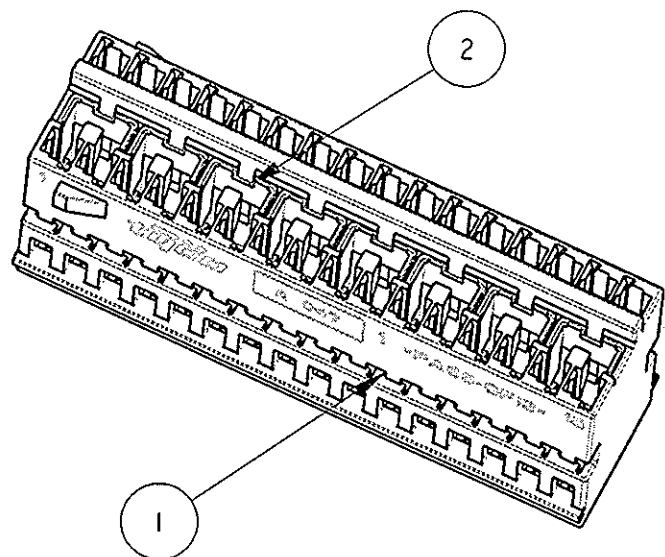

NOTES
(NOTE)

1) HOUSING SUITABLE FOR SHELL P/N 284715-2
(BLOCCHETTO ADATTO PER LA CORAZZA P/N 284715-2)

2) FOR MISSING NOTES AND DIMENSIONS SEE
P/N 284422-1, SHEET 1 OF 3
(PER LE NOTE E LE QUOTE MANCANTI VEDERE
P/N 284422-1, FOGLIO 1 DI 3)

ITEM (VOCE)	DESCRIPTION (DESCRIZIONE)	MATERIAL (MATERIALE)	Q.TY (Q.TA')
1	HOUSING (BLOCCHETTO)	PA 66 GF COLOR GRAY (COLORE GRIGIO)	1
2	SHORT CIRCUIT SPRING (MOLLA DI CORTO CIRCUITO)	STAINLESS STEEL (ACCIAIO INOX)	8

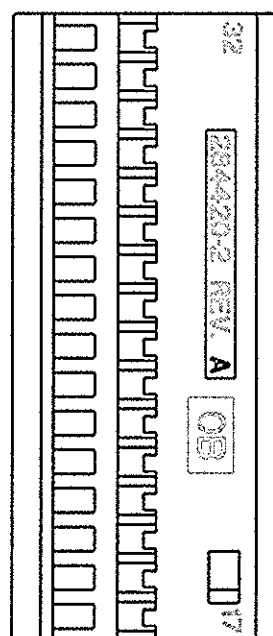
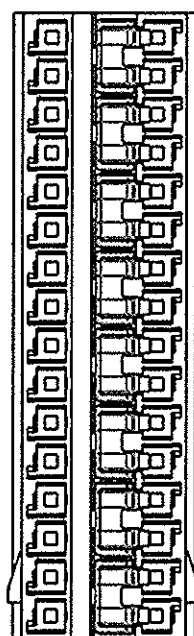
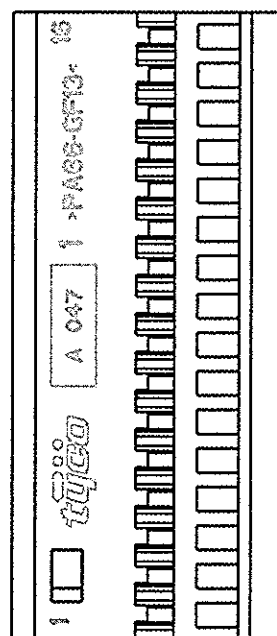

284422-2 AS SHOWN
(COME MOSTRATO)

<small>THIS DRAWING IS A CONTROLLED DOCUMENT FOR TYCO ELECTRONICS CORPORATION. IT IS SUBJECT TO CHANGE AND THE CONTROLLING ENGINEERING ORGANIZATION SHOULD BE CONTACTED FOR THE LATEST REVISION.</small>		DWN M. BARBERIS 04MAY2001 CHK O. CANUTO 04MAY2001 APVD A. GENTA PRODUCT SPEC APPLICATION SPEC WEIGHT - CUSTOMER DRAWING	tyco Electronics tyco Electronics AMP Italia S.p.A. C.so F.lli Cervi, 15 Collegno (TO)
DIMENSIONS: mm 	TOLERANCES UNLESS OTHERWISE SPECIFIED: 0 PLC ±0.3 1 PLC ±0.2 2 PLC ±0.1 3 PLC ± 4 PLC ± ANGLES ±1°	NAME 32 POSITIONS REC. HOUSING ASS'Y FOR AIRBAG SIZE A3 CAGE CODE 00779 DRAWING NO C=284422 RESTRICTED TO -	SCALE 2:1 SHEET 2 OF 3 REV A2
MATERIAL SEE TABLE (VEDI TABELLA)	FINISH SEE TABLE (VEDI TABELLA)		

P	LTR	DESCRIPTION	DATE	DWN	APVD
		SEE SHEET 1 (VEDI FOGLIO 1)			

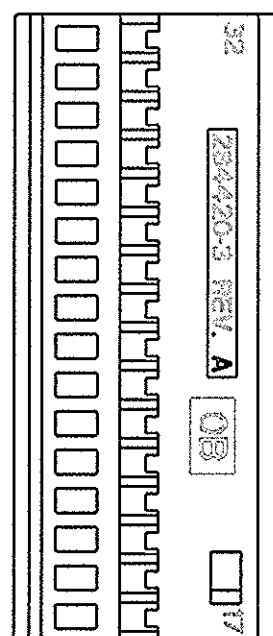
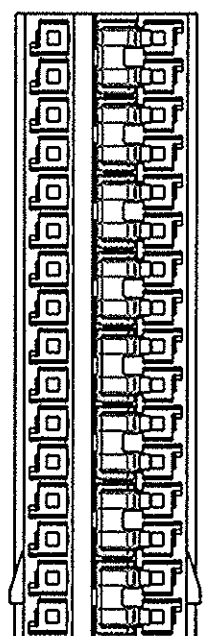
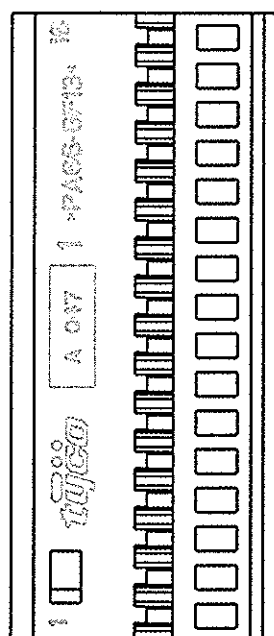
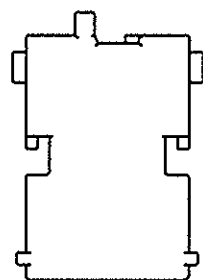
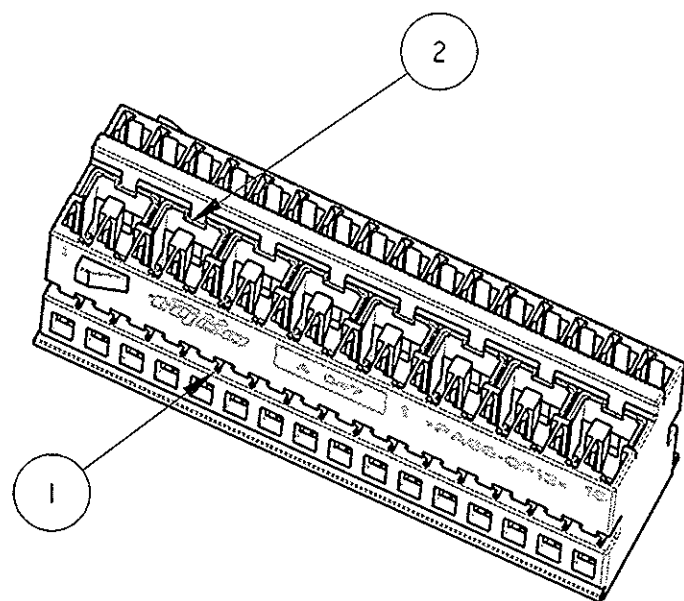

NOTES
(NOTE)

1) HOUSING SUITABLE FOR SHELL P/N 284715-3
(BLOCCHETTO ADATTO PER LA CORAZZA P/N 284715-3)

2) FOR MISSING NOTES AND DIMENSIONS SEE
P/N 284422-1, SHEET 1 OF 3
(PER LE NOTE E LE QUOTE MANCANTI VEDERE
P/N 284422-1, FOGLIO 1 DI 3)

ITEM (VOCE)	DESCRIPTION (DESCRIZIONE)	MATERIAL (MATERIALE)	Q.TY (Q.TA'')
1	HOUSING (BLOCCHETTO)	PA 66 GF COLOR BLUE (COLORE BLU)	1
2	SHORT CIRCUIT SPRING (MOLLA DI CORTO CIRCUITO)	STAINLESS STEEL (ACCIOIO INOX)	8

284422-3 AS SHOWN
COME MOSTRATO

<small>THIS DRAWING IS A CONTROLLED DOCUMENT FOR TYCO ELECTRONICS CORPORATION IT IS SUBJECT TO CHANGE AND THE CONTROLLING ENGINEERING ORGANIZATION SHOULD BE CONTACTED FOR THE LATEST REVISION.</small>		DWH 04MAY2001 M. BARBERIS CHK 04MAY2001 O. CANUTO APVD - A. GENTA PRODUCT SPEC - APPLICATION SPEC - WEIGHT -	tyco Electronics tyco Electronics AMP Italia S.p.A. C.so F.lli Cervi, 15 Collegno (TO)
DIMENSIONS: mm 	TOLERANCES UNLESS OTHERWISE SPECIFIED: 0 PLC ±0.3 1 PLC ±0.2 2 PLC ±0.1 3 PLC ±- 4 PLC ±- ANGLES ±1°	NAME 32 POSITIONS REC. HOUSING ASS'Y FOR AIRBAG	RESTRICTED TO -
MATERIAL SEE TABLE (VEDI TABELLA)	FINISH SEE TABLE (VEDI TABELLA)	SIZE A3 CAGE CODE 00779 DRAWING NO C-284422	SCALE 2:1 SHEET 3 OF 3 REV A2
CUSTOMER DRAWING		SCALE 2:1 SHEET 3 OF 3 REV A2	