

LOC	DIST	REV	DATE	BY	APPV
A1	-	A4	03SEP08	CA	VB

NUMER 965654  
 VERWENDET FÜR 967376  
 PASSEND ZU 967376  
 WAR NR. 93-52293-168

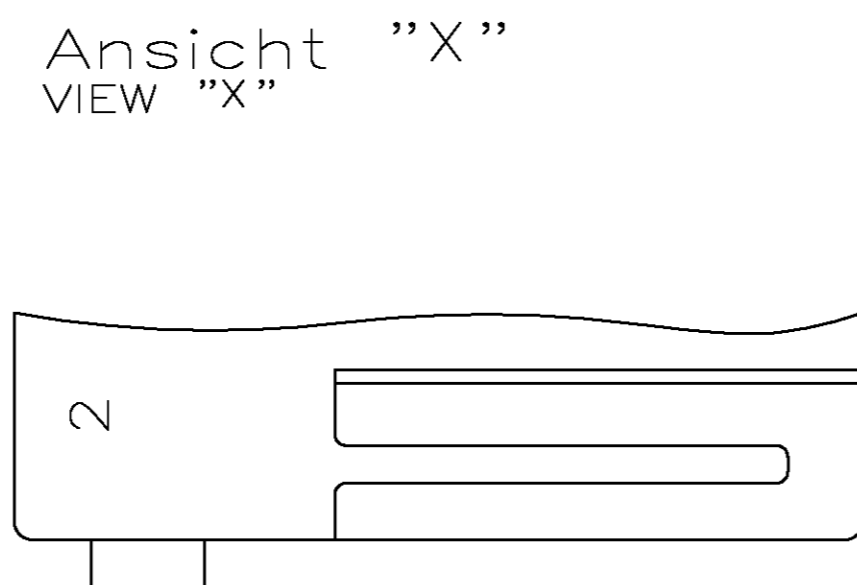

FOR SEC. LOCKING 965658  
 SAAB-NO. 4737094

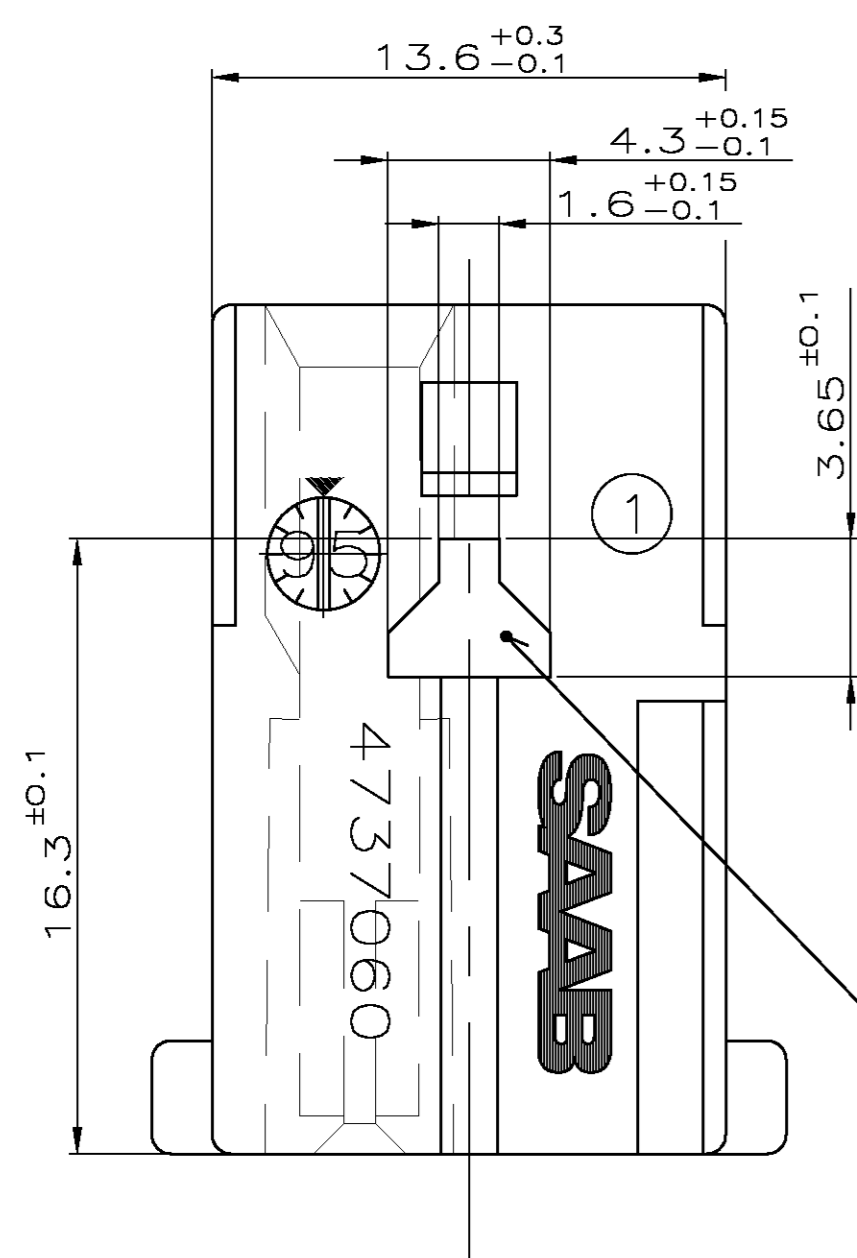
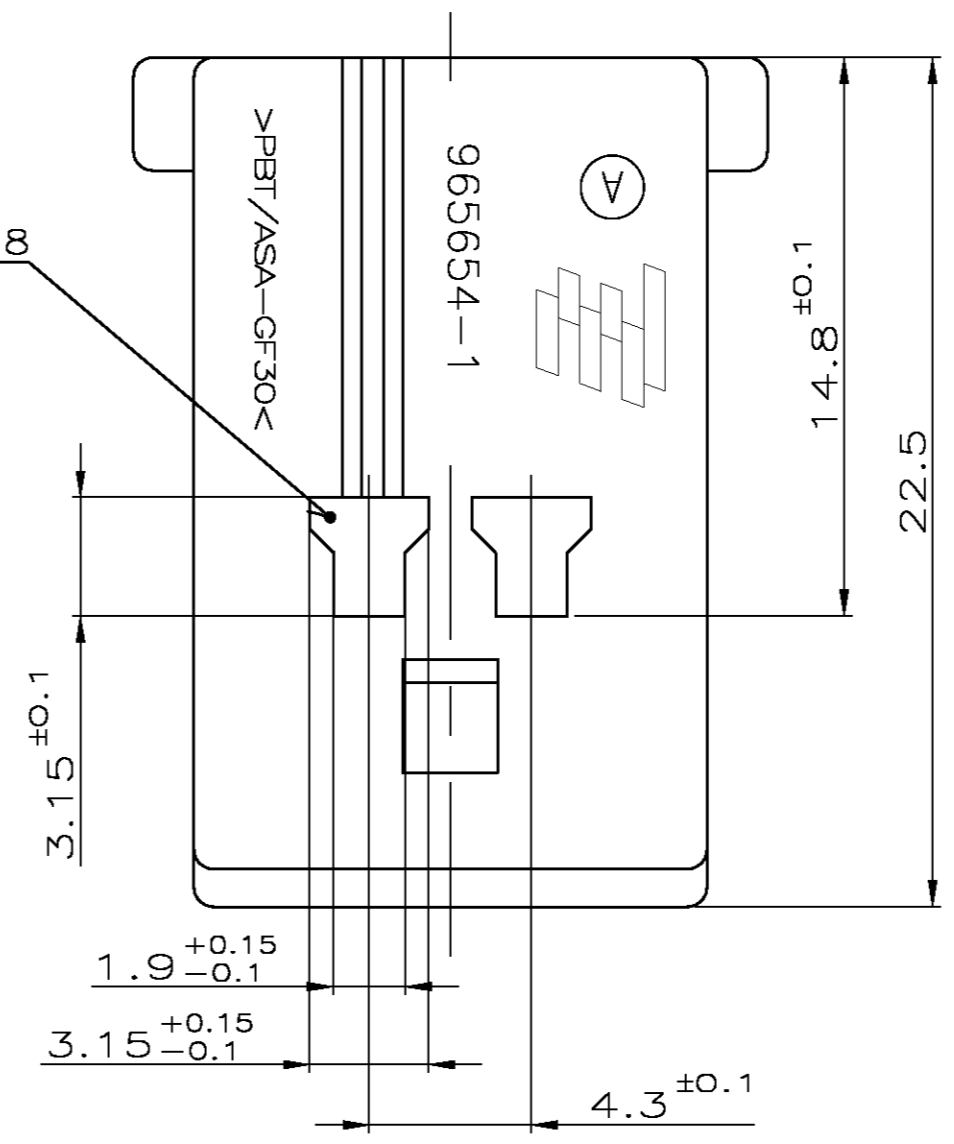

Schnitt SECTION A-B

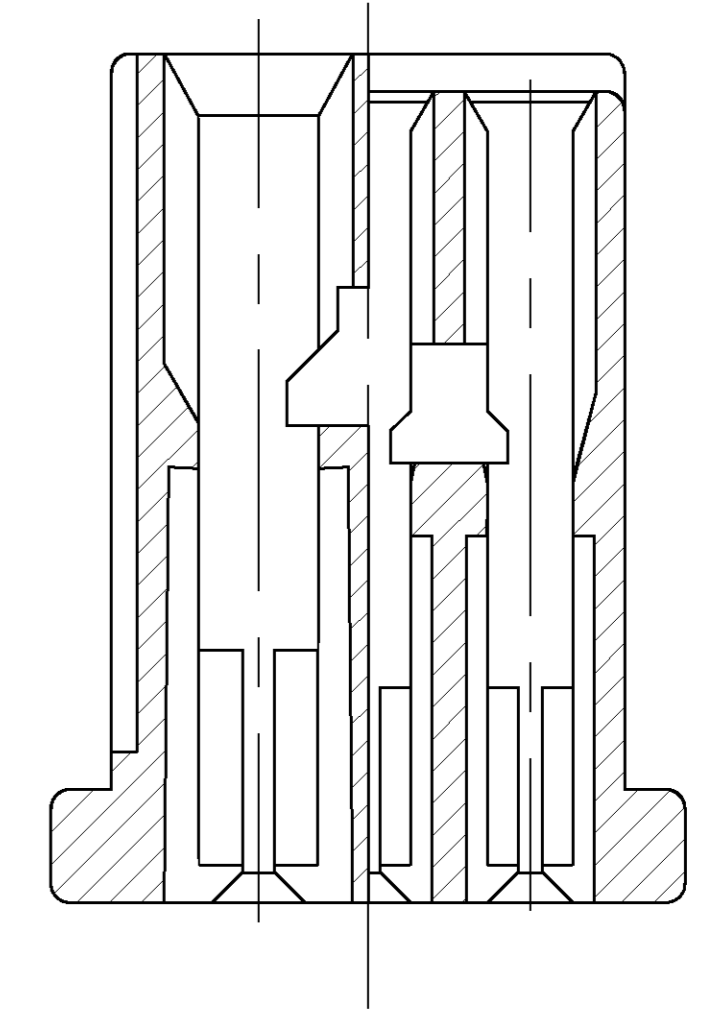

FOR SEC. LOCKING 965657  
 SAAB-NO. 4737086

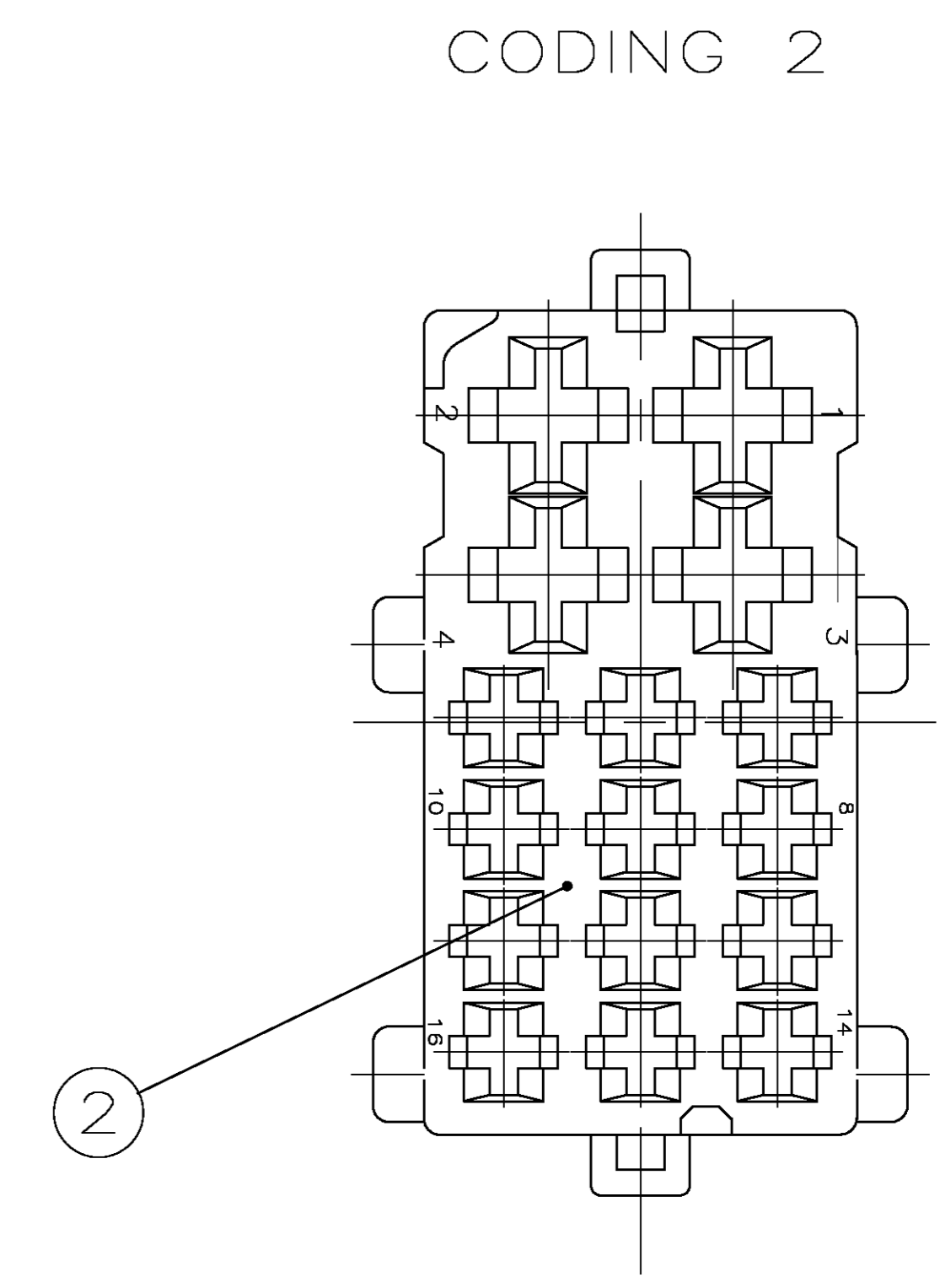
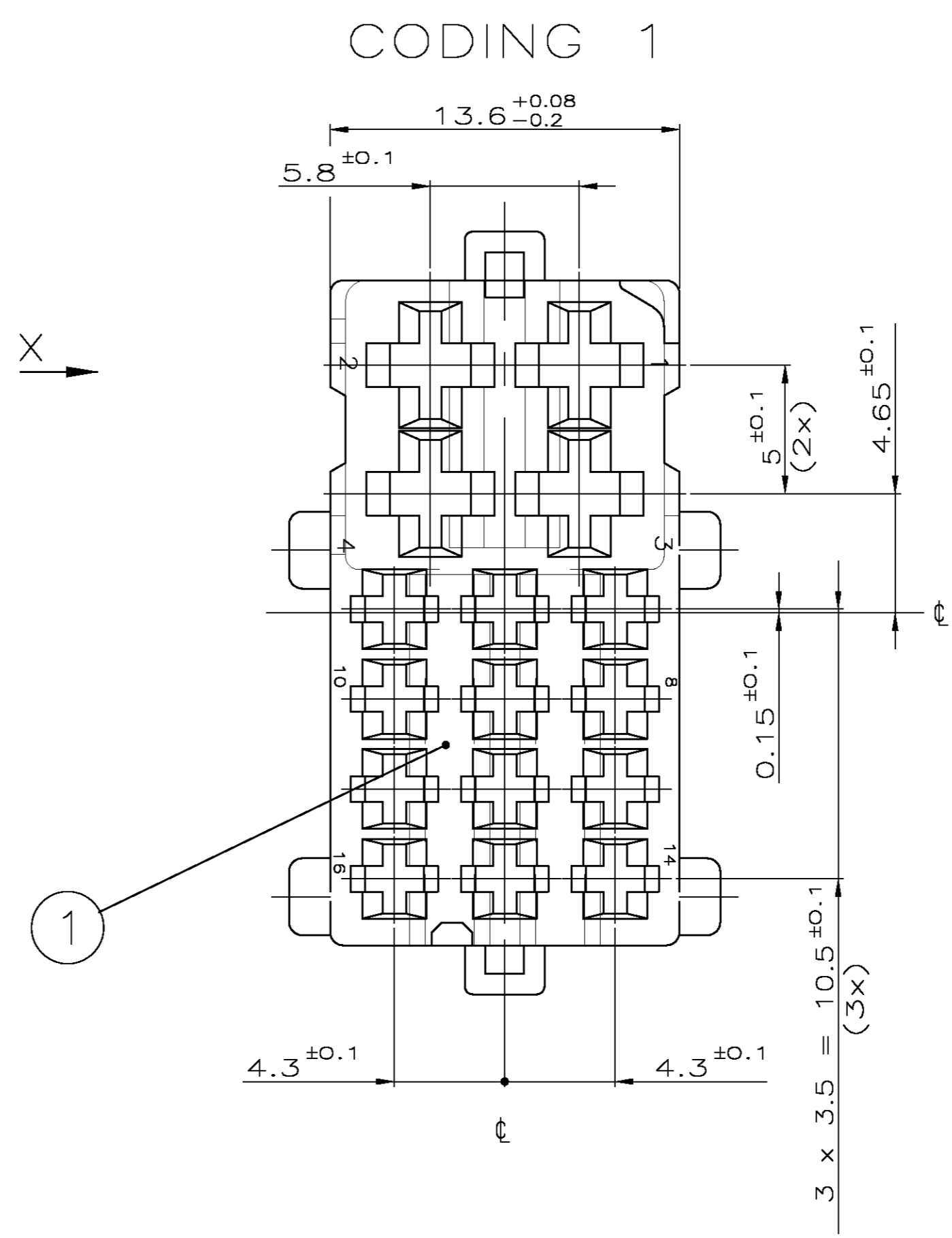
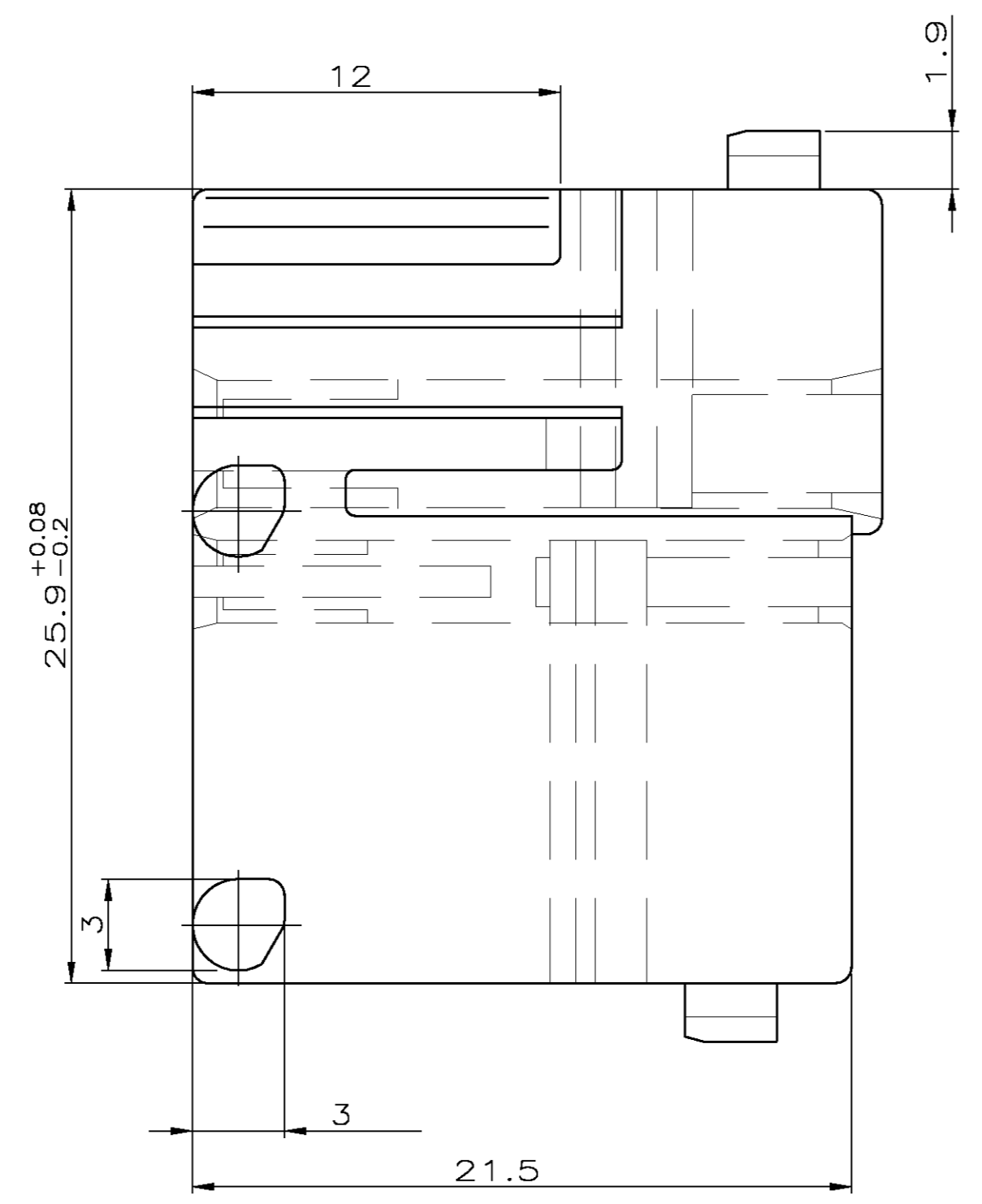
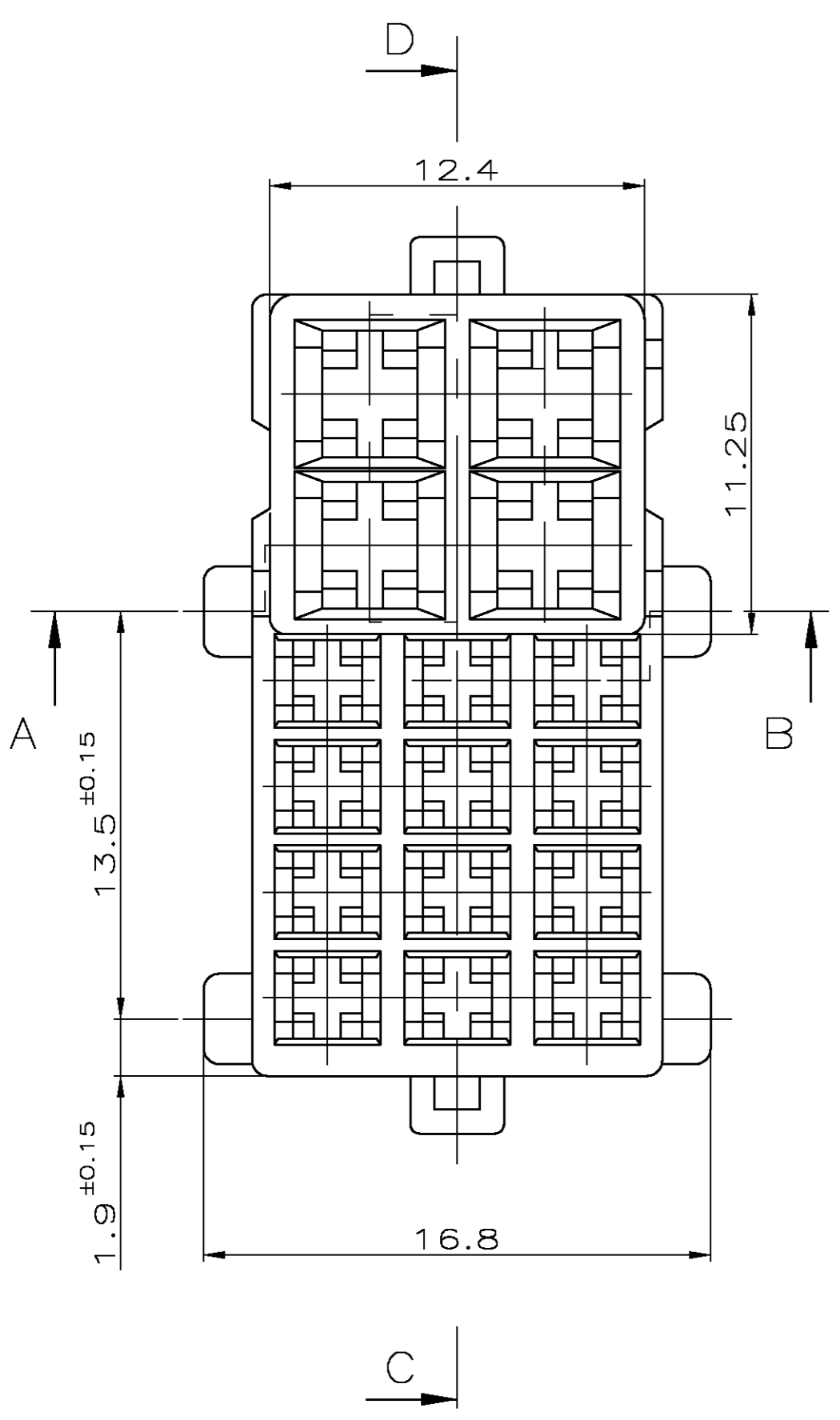

4737078	0-0965654-2	A	2	16POS. REC. HSG CODE 2	PBT/ASA-GF30	GREY
4737060	0-0965654-1	A	1	16POS. REC. HSG CODE 1	PBT/ASA-GF30	BLACK
SAAB NR.	BESTELL-NR.	REV.	POS.	BENENNUNG EINZELTEIL	WERKSTOFF	OBERFLÄCHE FARBE

THIS DRAWING IS A CONTROLLED DOCUMENT.

DIMENSIONS: mm	TOLERANCES UNLESS OTHERWISE SPECIFIED:	DWN H Gehrke 07-MAR-95	CHK A. Machill 11-MAR-95	NAME	16 POS. MIX REC. HOUSING 4x JPT AND 12x MICRO TIMER 2
MATERIAL	FINISH	PRODUCT SPEC	APPLICATION SPEC	SIZE	CAGE CODE
		WEIGHT		A1	00779
		CUSTOMER DRAWING	SCALE 5:1	SHEET 1 of 1	REV A4

Tyco Electronics Tyco Electronics Corporation  
 64625 Bensheim, Germany