

TERMINATION TOOL ASSEMBLY	FIRST USED (APPLICATION)	LEAD WIRE (AWG) ††	TERMINAL TYPE (Fig. 4)	INSERTION TOOL TIP
1725815-1	Wire-to-Wire with Lead Lok	18	I	1725850-1
1725815-2	FASTON* (Shoulder Connector)	N/A	N/A	1725854-1
1725815-3	FASTON Connector	N/A	N/A	1725855-1
1725815-4	PC Tab Connector	N/A	N/A	1725853-1
1725815-5	Long Post Connector	N/A	N/A	1725852-1
1725815-6	Wire-to-Wire with Lead Lok	18	II	1725850-2
1725815-7	Wire-to-Wire with Lead Lok	20	I	1725850-3
1725815-8	Wire-to-Wire with Lead Lok	20	II	1725850-4
1725815-9	FASTON (.187 Connector)	N/A	N/A	1725855-2
1-1725815-0	Wire-to-Wire Connector †	18	I	1725850-5
1-1725815-1	Wire-to-Wire Connector †	18	II	1725850-6
1-1725815-2	Wire-to-Wire Connector †	20	I	1725850-7
1-1725815-3	Wire-to-Wire Connector †	20	II	1725850-8

† Used with Lead Lok Terminal

†† A Stranded, Solid, or Bonded Wire Inserted into the Top of the Terminal

Figure 1

1. INTRODUCTION

This instruction sheet covers the use of TE manual insertion tools for SIAMEZE terminals. The tools are available in two general categories: the arbor frame assemblies (Figure 1) and the hand insertion Repair Tools (Figure 2).

In addition, insertion tool tips (Figure 3) are available for the arbor frame assemblies and the repair tools for purposes of replacement, for those instances where a tip is required to insert a different terminal or for use in an existing manual arbor frame or repair tool.

Repair Tool 1725385-[]

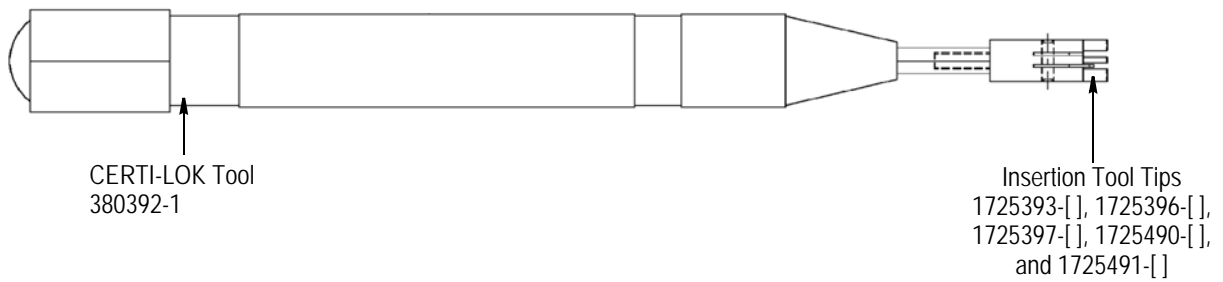

TERMINATION TOOL ASSEMBLY	FIRST USED (APPLICATION)	LEAD WIRE (AWG) ‡	TERMINAL TYPE (Fig. 4)	INSERTION TOOL TIP
1725385-1	Wire-to-Wire with Lead Lok	18	I	1725393-1
1725385-2	Wire-to-Wire with Lead Lok	20	I	1725393-2
1725385-3	FASTON (Shoulder Connector)	N/A	N/A	1725396-1
1725385-4	FASTON Connector	N/A	N/A	1725397-1
1725385-5	PC Tab Connector	N/A	N/A	1725490-1
1725385-6	Long Post Connector	N/A	N/A	1725491-1
1725385-7	Wire-to-Wire with Lead Lok	18	II	1725393-5
1725385-8	Wire-to-Wire with Lead Lok	20	II	1725393-6
1725385-9	FASTON (.187 Connector)	N/A	N/A	1725397-2

‡ A Stranded, Solid, or Bonded Wire Inserted into the Top of the Terminal

Figure 2

These tools insert wire-to-wire terminals with Lead Lok, FASTON terminals, PC tab terminals, and long post terminals into coil bobbins and motor stators.

Read these instructions before using the insertion tool equipment to insert terminals.

Reasons for re-issue are contained in Section 6, REVISION SUMMARY.

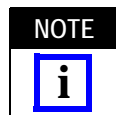

The tool tips have been designed for bobbin/stator housings that comply with the cavity specifications as indicated on the appropriate Tyco Electronics Customer Product Drawing.

Wire-to-wire terminal types are illustrated in Figure 4 and referenced in Figure 1 and Figure 2.

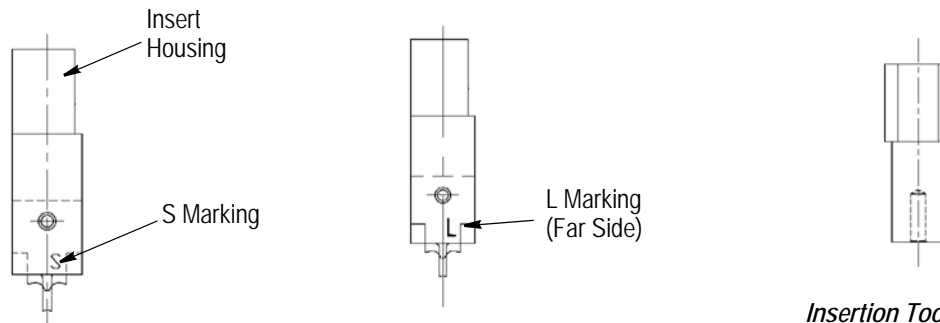

Insertion Tool Tips 1725850-[] and 1725393-[] (Typ)

Insertion Tool Tips 1725852-[], 1725853-[], 1725854-[], 1725855-[], 1725490-[], 1725491-[], 1725391-[], 1725396-[] and 1725397-[] (Typ)

Figure 3

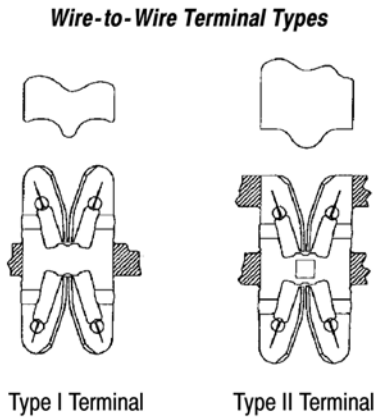

Figure 4

2. DESCRIPTION

2.1. Arbor Frame Assemblies 1725815-[]

These arbor frame assemblies consist of an arbor frame (PanaPress1/4 Ton Arbor Frame Assembly), a special baseplate, and one of a number of insertion tool tips. Refer to Figure 1.

The insertion tool tips include a main body (housing) that mounts in the arbor frame ram in an existing 1/4-inch hole and are secured by setscrews.

The tips are used to insert wire-to-wire connectors, FASTON connectors, PC tab connectors, and Long Post Connectors. Refer to Figure 1 for a cross-reference between the arbor frame assemblies, insertion tool tips, and possible applications.

FASTON terminals, PC tabs, and long post tip contacts contain a solid push body.

Each wire-to-wire tip contains separate push blades: one blade for wire-to-wire terminal applications; and one blade for Lead Lok strain relief applications.

2.2. Repair Tool 1725385-[]

The repair tools consist of an insertion tool tip mounted to CERTI-LOK Termination Tool 380392-1. Refer to Figure 2.

These tools are used to insert wire-to-wire connectors, FASTON connectors, PC tab connectors, and Long Post Connectors. Refer to Figure 2 for a cross-reference between the repair tools, insertion tool tips, and possible applications.

Each wire-to-wire tip consists of a main body and separate push blades. One blade is used for wire-to-wire applications. One blade is used for Lead Lok terminal applications.

3. ARBOR FRAME ASSEMBLY OPERATION (Figure 5)

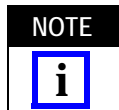
NOTE
 For best results a customer fabricated holding fixture should be made by the user to securely hold the bobbin/stator during the insertion process. Failure to do so may result in damage to the work piece, the SIAMEZE terminal, the insertion tip, or injury to the operator.

1. Align the tip to any specific work piece holding fixture and / or alignment device.

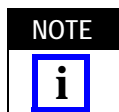
NOTE
 The wire-to-wire tips aligns with the "S" or "L." marked on the insertion tool tip. The "S" and "L" correspond to SIAMEZE and Lead Lok, respectively. Refer to Figure 3.

2. Load the bobbin/stator onto the customer supplied holding fixture.

3. Place the wire-to-wire terminals into the correct cavity locations for each magnet wire. Ensure that the terminal is oriented correctly. See Figure 5.

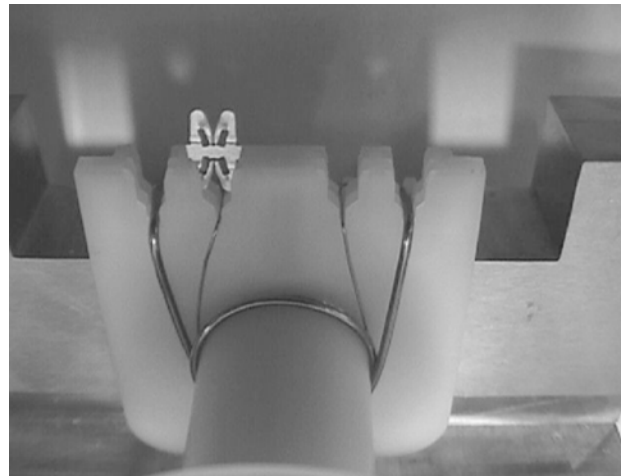

Figure 5

4. Lower the arbor frame ram until the tool tip bottoms on the connector housing. See Figure 6.

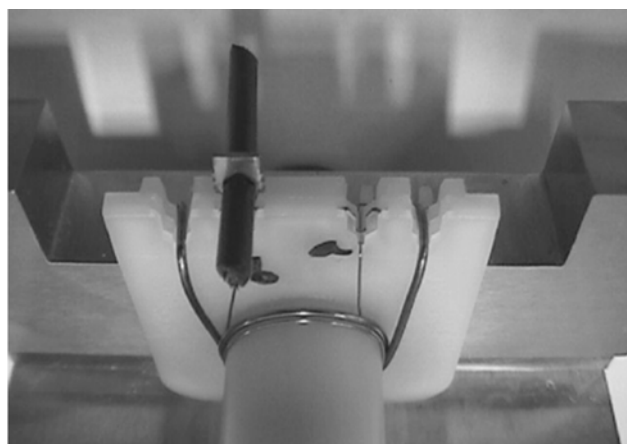

Figure 6

5. Raise the arbor frame ram and repeat the process for the remaining wire-to-wire terminals.
6. Place a lead wire in position with the Lead Lok terminal started into the appropriate cavity location, as illustrated in Figure 7.

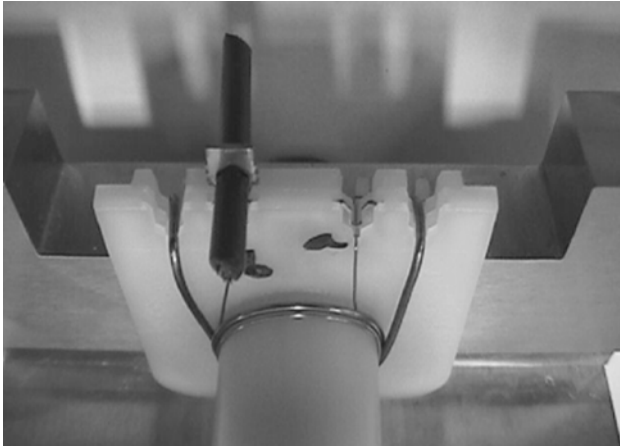

Figure 7

7. Lower the arbor frame ram until the tooling tip bottoms on the housing. See Figure 8.

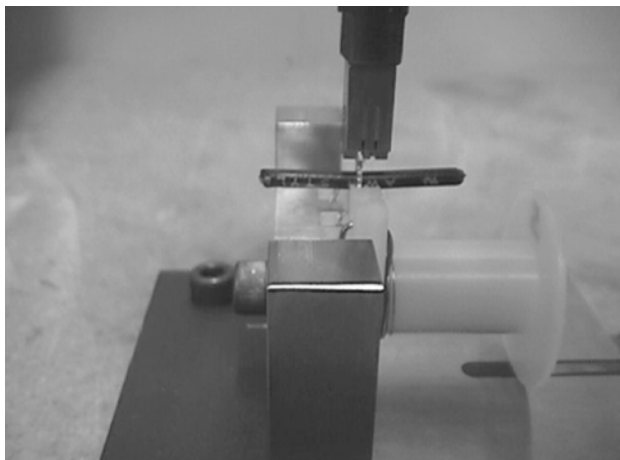
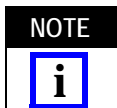

Figure 8

8. Raise the ram and repeat for the remaining lead wires and Lead Lok terminals.

4. REPAIR TOOL OPERATION



For best results a customer fabricated holding fixture should be made by the user to securely hold the bobbin/stator during the insertion process. Failure to do so may result in damage to the work piece, the SIAMEZE terminal, the insertion tip, or injury to the operator.

1. Load the bobbin/stator onto the holding fixture.

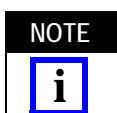

Each wire-to-wire tip aligns with the "S" or "L." marked on the insertion tool tip. The "S" and "L" correspond to SIAMEZE and Lead Lok. See Figure 3.

2. Place the wire-to-wire terminals into the appropriate cavity locations for each magnet wire. Ensure that the terminal is oriented correctly, as shown in Figure 5.
3. Place the insertion tip over the terminal and press downward until the repair tool actuates. Ensure that the tip bottoms on the connector housing for proper terminal placement into the housing cavity. See Figure 6.
4. Repeat the process for the remaining wire-to-wire terminals.
5. Place a lead wire in position with the Lead Lok terminal started into the appropriate cavity location. See Figure 7.
6. Place the insertion tip over the terminal and press downward until the repair tool actuates. Repeat the actuation of the repair tool until the insertion tool tip bottoms on the connector housing. The bottoming action of the tip assures the proper terminal placement in the housing cavity. Lead Lok terminals will be flush with the top of the housing when they are fully seated. See Figure 8.

5. MAINTENANCE

To maintain this equipment in optimum operating condition, it is recommended that the tooling be serviced regularly.

Although the servicing schedule depends on the amount of tooling use, the following should be considered in the servicing schedule:

- Clean the tooling regularly.
- Visually inspect the push blades for damage.
- Visually inspect the connector housing for damage.
- Be sure magnet wire has not accumulated in or around the push blades.
- Ensure that the insertion tool tip is securely fastened to either the arbor frame ram, or repair tool to reduce breakage of the threaded stud.

6. REVISION SUMMARY

Revisions to this instruction sheet include:

- Changed company name and logo