

REVISIONS

P	LTR	DESCRIPTION	DATE	DWN	APVD
	BA	NEW RELEASE	23-MAR-10	MRS	St.P
	BB	CLARIFICATION OF DIMENSIONS	18JAN2023	DM	AP

FOR FURTHER INFORMATION SEE DATA SHEET FOR SERIES LR, METAL FILM FIXED RESISTORS



RoHS Compliant

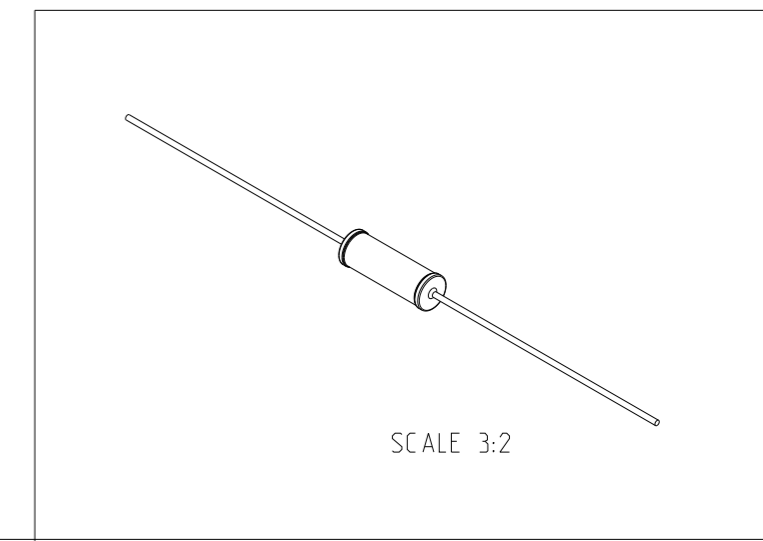

THIS DRAWING IS A CONTROLLED DOCUMENT.		DWN MAHARUDRA 23-MAR-10														
DIMENSIONS: mm		CHK ALLAN.P 23-MAR-10														
TOLERANCES UNLESS OTHERWISE SPECIFIED:		APVD STEPHEN.P 23-MAR-10														
<table border="1"> <tr> <td>0 PLC</td> <td>±0.2</td> </tr> <tr> <td>1 PLC</td> <td>±0.1</td> </tr> <tr> <td>2 PLC</td> <td>±-</td> </tr> <tr> <td>3 PLC</td> <td>±-</td> </tr> <tr> <td>4 PLC</td> <td>±-</td> </tr> <tr> <td>ANGLES</td> <td>±5°</td> </tr> </table>		0 PLC	±0.2	1 PLC	±0.1	2 PLC	±-	3 PLC	±-	4 PLC	±-	ANGLES	±5°	PRODUCT SPEC -	NAME METAL FILM FIXED RESISTORS SERIES LR2	
0 PLC	±0.2															
1 PLC	±0.1															
2 PLC	±-															
3 PLC	±-															
4 PLC	±-															
ANGLES	±5°															
MATERIAL -		FINISH -	APPLICATION SPEC -	RESTRICTED TO -												
		WEIGHT -	SIZE A3	CAGE CODE 00779												
			DRAWING NO C=1622737													
		CUSTOMER DRAWING	SCALE 8:1	SHEET 1 OF 1												
				REV BB												