

REVISIONS

P	LTR	DESCRIPTION	DATE	DWN	APVD
	BA	NEW RELEASE	06JULY2010	PT	St.P
	BB	CLARIFICATION OF DIMENSIONS	18JAN2023	DM	AP

FOR FURTHER INFORMATION SEE DATA SHEET FOR SERIES LR, METAL FILM FIXED RESISTORS

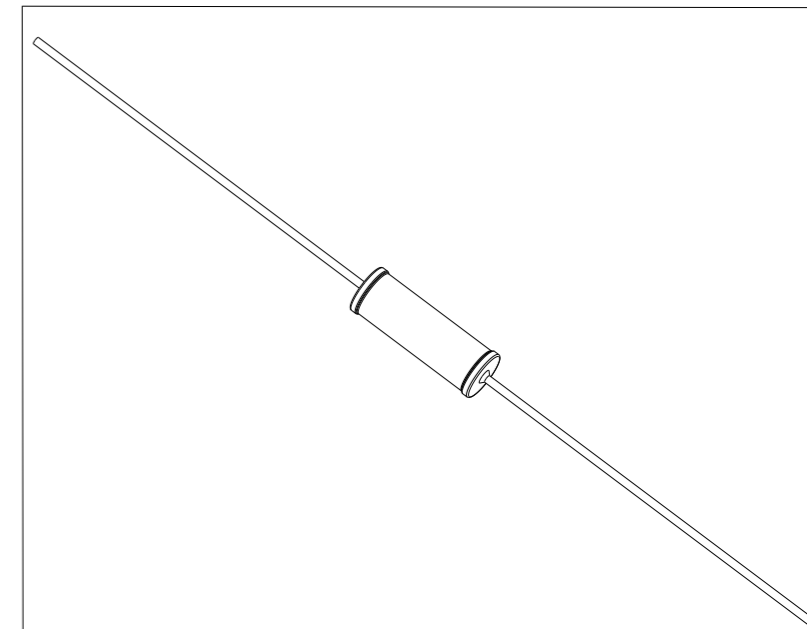
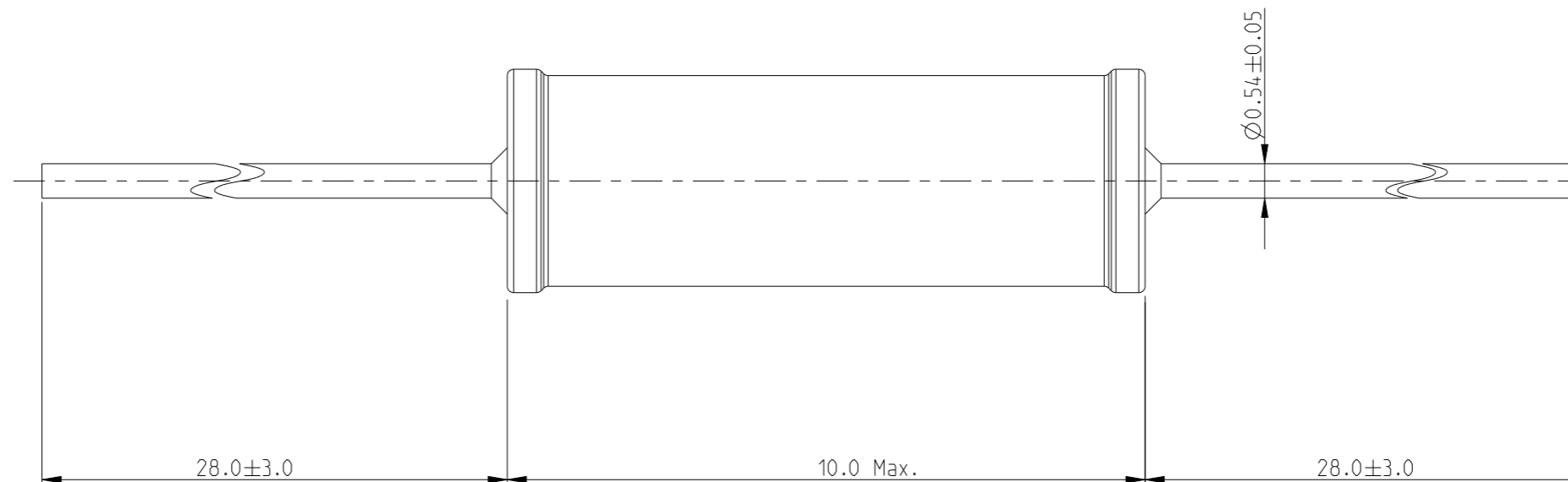
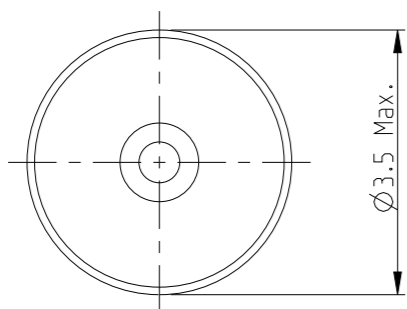

RoHS Compliant

THIS DRAWING IS A CONTROLLED DOCUMENT.	
DIMENSIONS: mm	TOLERANCES UNLESS OTHERWISE SPECIFIED:
	0 PLC ± 0.2 1 PLC ± 0.1 2 PLC \pm 3 PLC \pm 4 PLC \pm ANGLES $\pm 5^\circ$
MATERIAL -	FINISH -

DWN	06JULY2010
CHK	06JULY2010
APVD	06JULY2010
PRODUCT SPEC	-
APPLICATION SPEC	-
WEIGHT	-
CUSTOMER DRAWING	

		NAME	
		METAL FILM FIXED RESISTORS SERIES LR2	
SIZE	CAGE CODE	DRAWING NO	RESTRICTED TO
A3	00779	C=1622772	-
SCALE		SHEET	REV
10:1		1 OF 1	BB