

REVISIONS				
P	LW	DESCRIPTION	DATE	BY / APPD
B1		REVISED PER ECR-17-013047	12SEP2017	J.Z. D.Z.

- PARTS MUST COMPLY WITH AMP SOLDERABILITY SPECIFICATION 109-11-3.
- WIRE RANGE: 0.8 - 2.0 mm² [18 - 14 AWG].
- INSULATION RANGE: 2.29 - 3.81 [.090 - .150] DIAMETER
- FITS A 1.57 [.062] THICK P.C. BOARD.

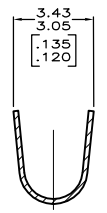

SECTION A-A

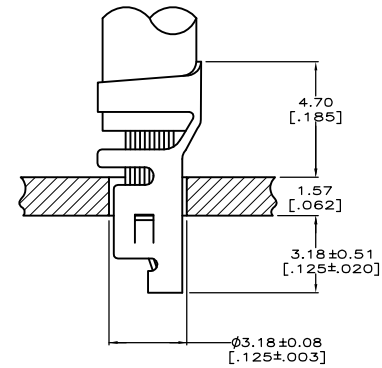
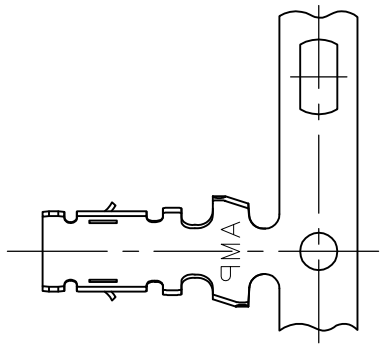
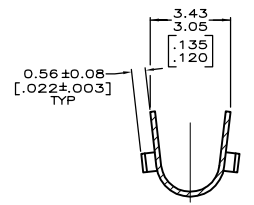

SECTION B-B

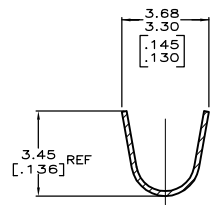
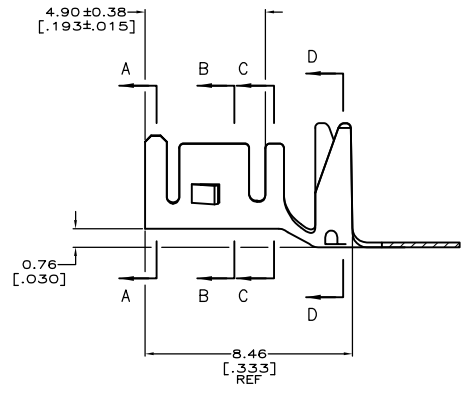

SECTION C-C

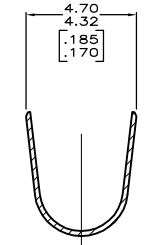

SECTION D-D

YES	0.00508	.000200	BRIGHT TIN	0.198	[.0078]	PH BRZ	3-647334-1
NO	0.00508	.000200	BRIGHT TIN-LEAD	0.198	[.0078]	PH BRZ	647334-1
LEAD FREE	FINISH			MATERIAL		PART NUMBER	

METRIC

THIS DRAWING IS A CONTROLLED DOCUMENT. DR: X. WHITAKER 130072004
 DESIGNED BY: J. ELLIS 130072004
 CHECKED BY: J. ELLIS 130072004
 DATE: 12/13/00

TE Connectivity
 TERMINAL, MINI AMP-IN™ 2000

WEIGHT: 0.000000
 PART NUMBER: A1 00779 647334
 CUSTOMER DRAWING

SCALE: 10:1 SHEET 1 OF 1 REV B1