

REV	DATE	BY	CHK	APPV	DESCRIPTION	ECN
D6	09MAY07	TS	KB		OBSOLETE -3	ECR-07-009593
E	09JUL07	KF	HY		REVISIED	ECR-07-014805
E1	18JAN2012	TS	KB		REVISIED	ECR-12-000967
E2	16MAR2017	KF	TK		REVISIED	ECR-16-003439

DIMENSIONS FOR PCB
 (CONNECTOR MOUNTING SIDE)
 プリント基板取付寸法 (コネクタ搭載側)

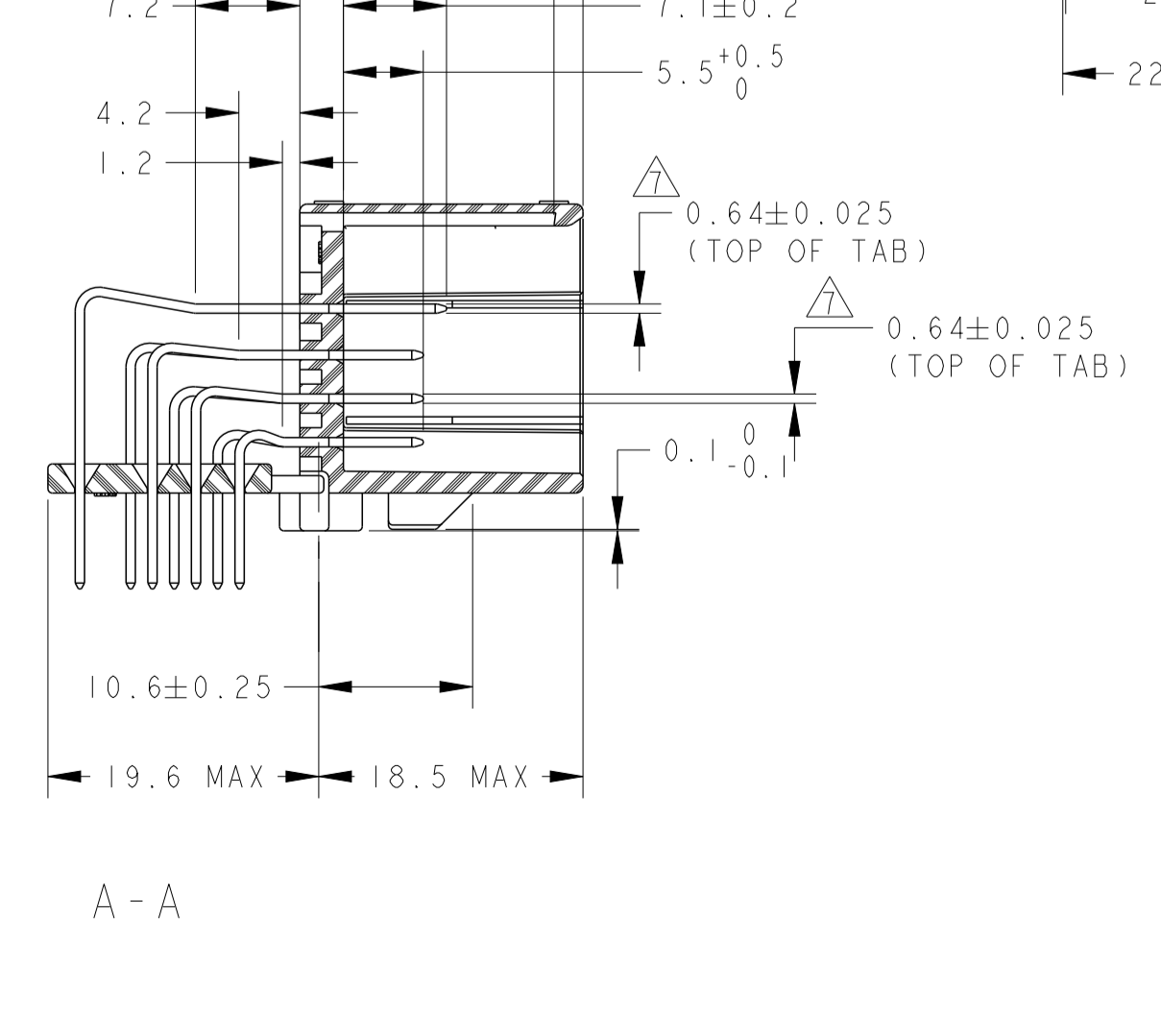
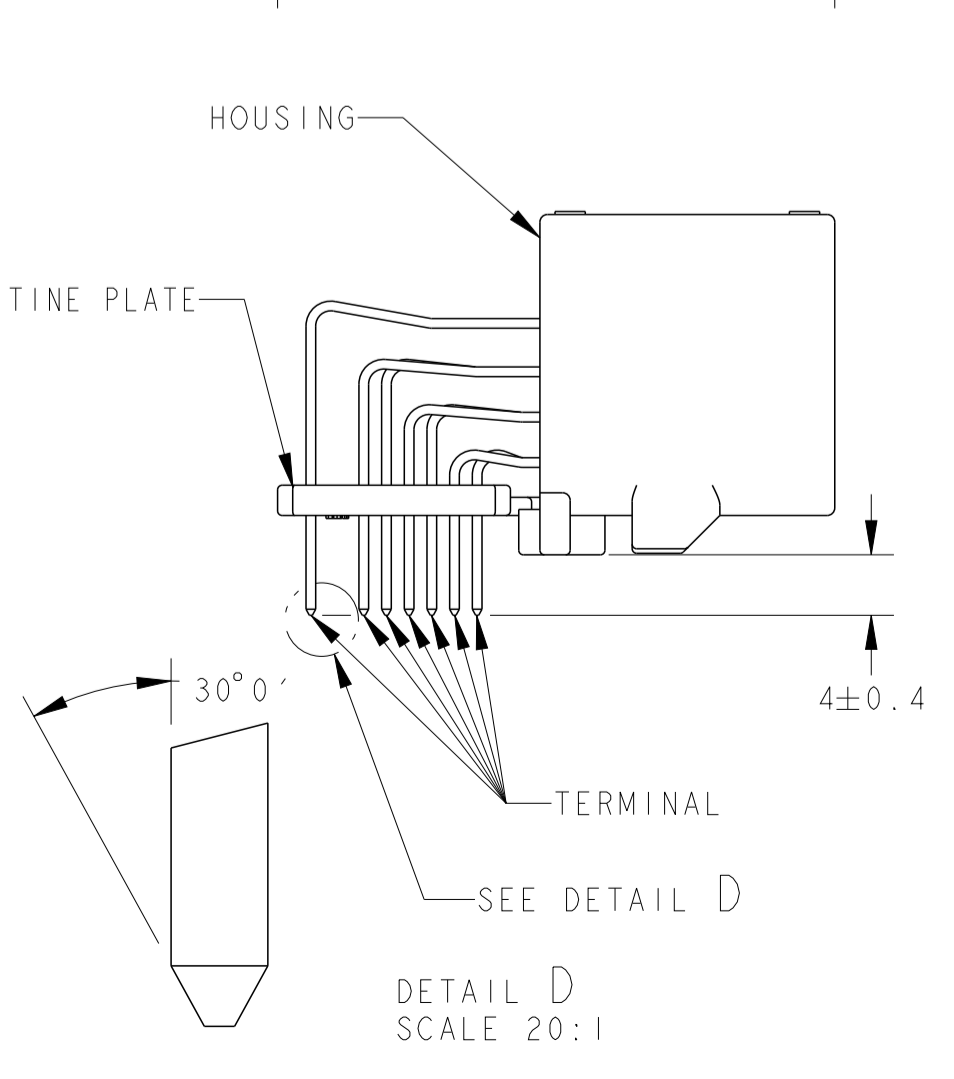
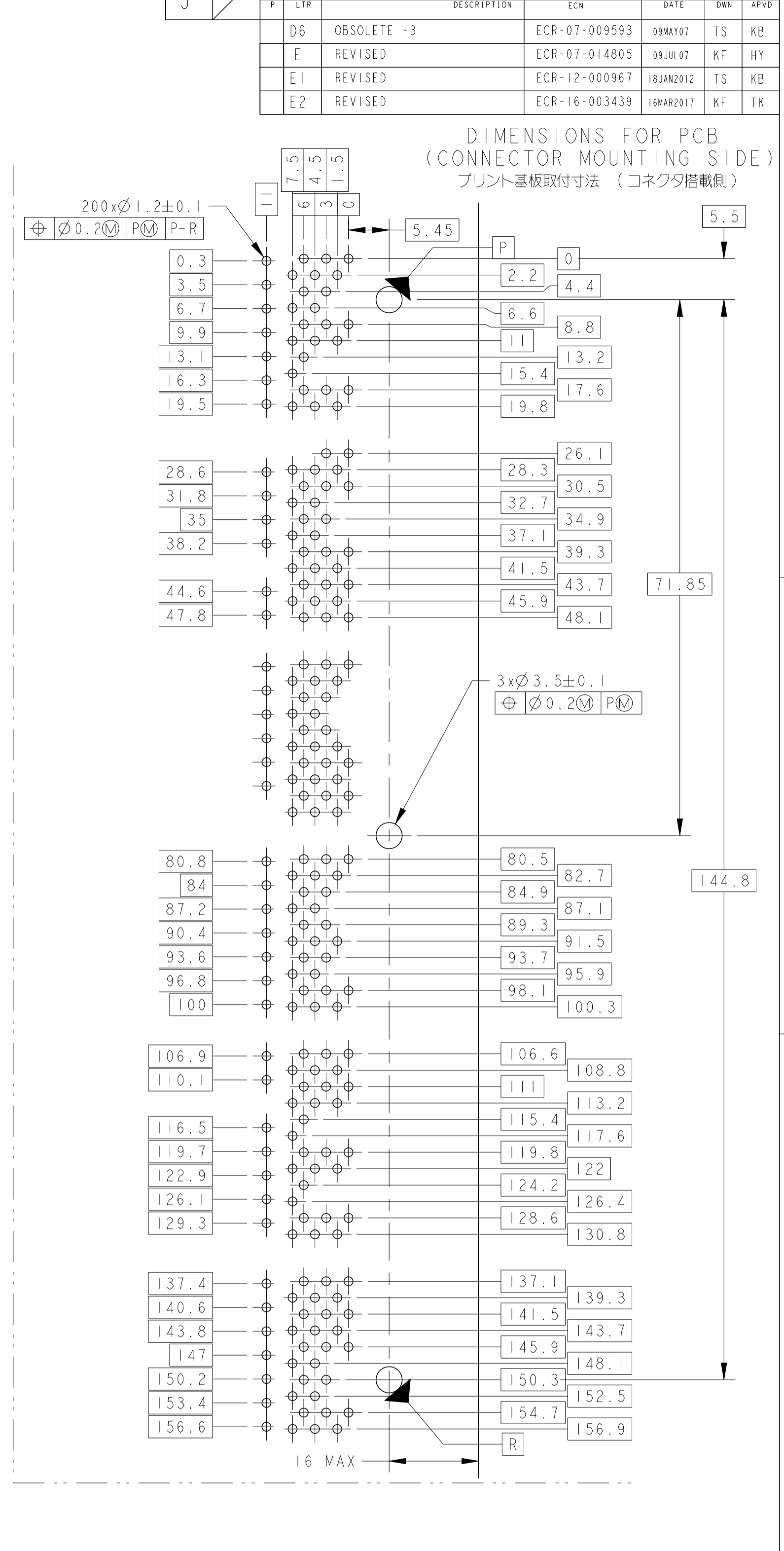
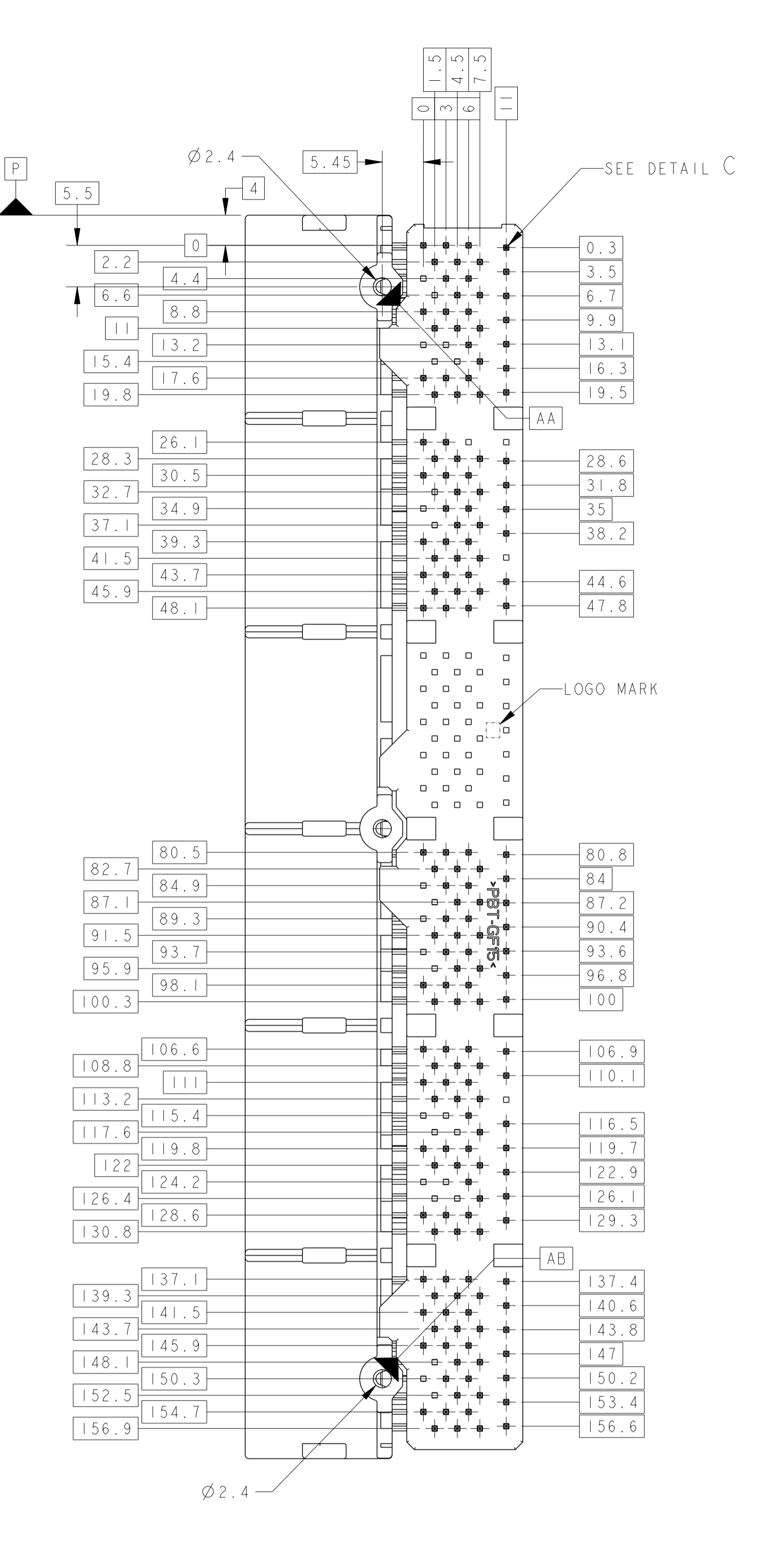
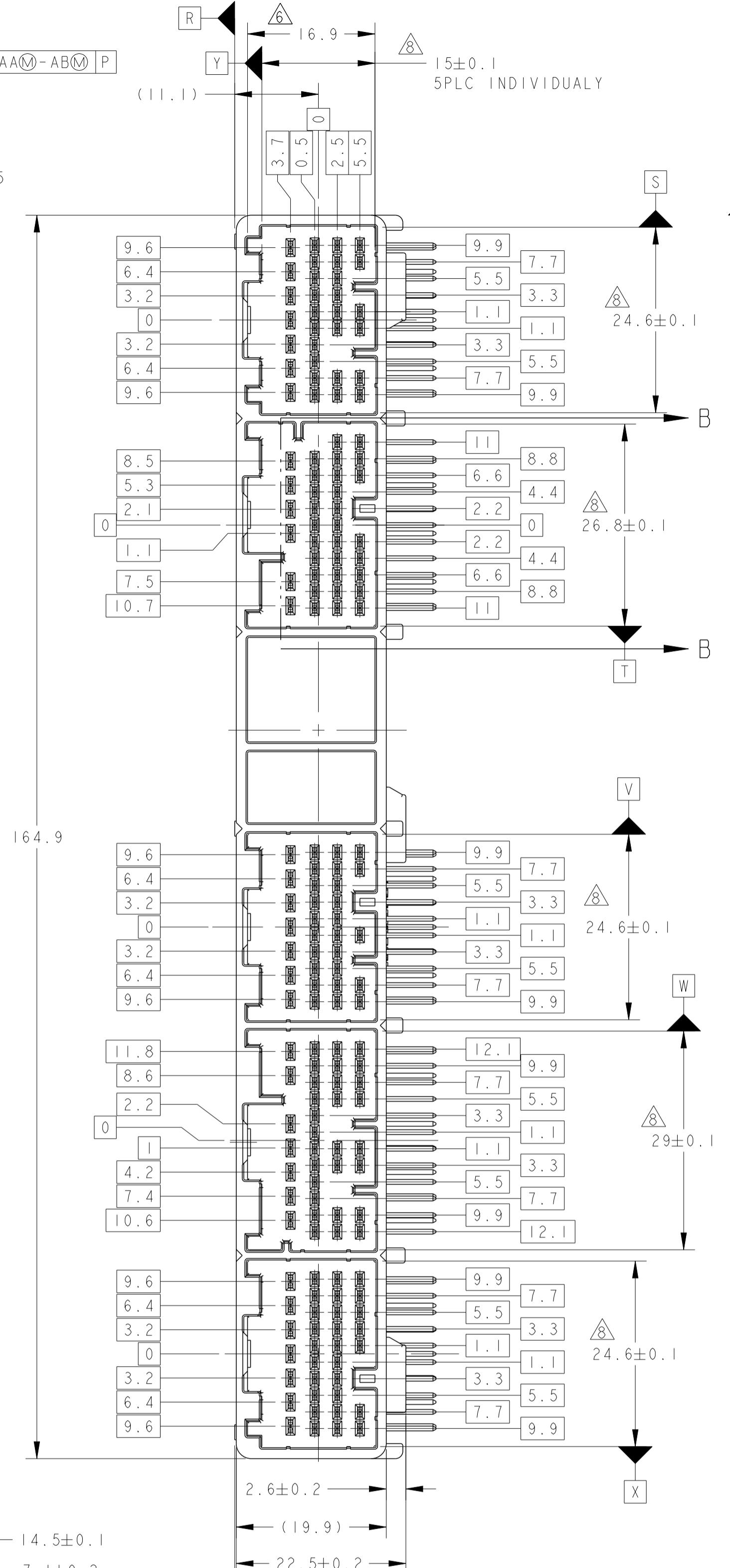
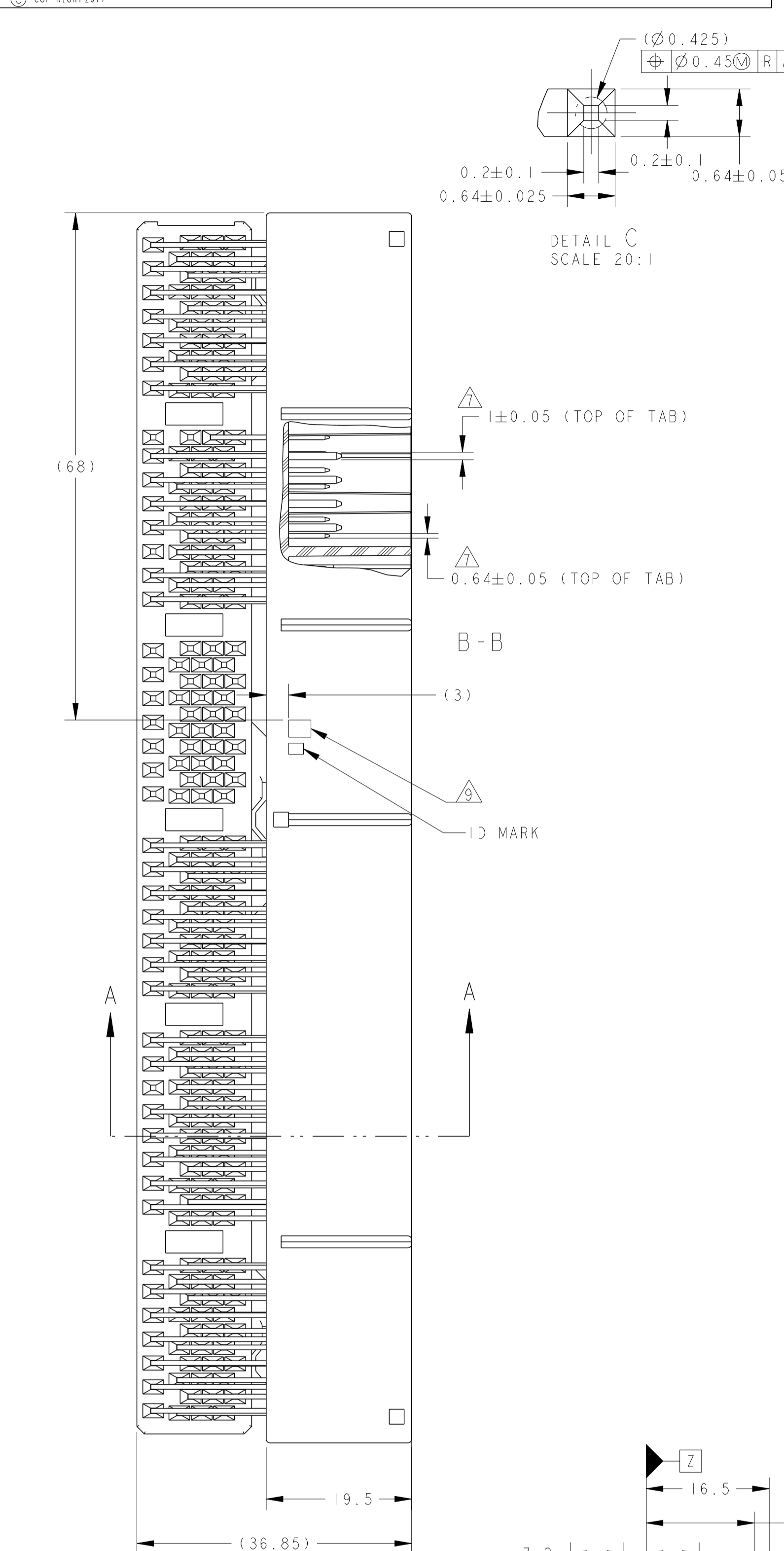

1. 嵌合相手ハウジング型番: TABLE-1参照
2. パワ回路(32極): FIG.1参照
3. 回路番号: FIG.1参照
4. 推奨取り付け: JIS B1115, B1122タッピングねじ, ねじ2種, 呼び径3, 長さ: TABLE-1参照
5. ねじ締めトルク: 0.392N・m MAX
6. Zの2mmの位置で測定
7. 0.3(Z) Y(DTM) 組し, 3次DTMについては, S, T, V, W, Xを各々のブロック毎に適用すること
8. Zの7.5mmの位置で測定
9. コンタクト仕上識別用マーク: 表参照
10. 取扱説明書 NO.: 411-5932

1. PART NO OF PLUG HOUSINGS TO BE MATED:SEE TABLE 1
2. POWER CIRCUITS (32); SEE FIG.1
3. CIRCUIT NUMBERS ;SEE FIG.1
4. RECOMMENDED SCREW: PAN-HEADED, TYPE 2 TAPPING SCREW, NOMINAL DIAMETER 3mm LENGTH; SEE TABLE-1(JIS B1115, B1122).
5. FASTENING TORQUE FOR SCREW: 0.392N・m MAX.
6. MEASURED AT 2mm FROM Z
7. 0.3(Z) Y(DTM) TERTIARY DATUM; S, T, V, W, X OF EACH BLOCK.
8. MEASURED AT 7.5mm FROM Z
9. MARKING FOR DESCERNMENT OF THE CONTACT FINISH; SEE TABLE 10.
10. INSTRUCTION SHEET NO.:411-5932

プリント基板厚 (mm) THICKNESS OF PCB (mm)	1.2	1.6
固定用ねじ着下長さ (mm) NOMINAL LENGTH OF SCREW (mm)	5	6

THIS DRAWING IS A CONTROLLED DOCUMENT.

OWNER: H. FURUYAMA	DATE: 10FEB2000	REV: 025/040 EFL ECU CONNECTOR
CHK: N. SAI	DATE: 10FEB2000	167 POSITION CAP HOUSING ASSEMBLY
APVD: N. SAI	DATE: 10FEB2000	SIZE: A1
PRODUCT SPEC: 08-5674	APPLICATION SPEC: 114-5217, 5250	CAGE CODE: 00779
MATERIAL: PBT GF15 BRASS	FINISH: SEE TABLE	WEIGHT: 53.1 g
CUSTOMER DRAWING		DRAWING NO: 1318813

TE Connectivity

RESTRICTED TO

SCALE: 2:1 SHEET 1 OF 3 REV: E2

THIS DRAWING IS UNPUBLISHED. RELEASED FOR PUBLICATION 2017
 © COPYRIGHT 2017 ALL RIGHTS RESERVED.

LOC		DIST		REVISIONS			
P	LTR	DATE	DWN	APVD	DESCRIPTION		
J	-				SEE SHEET 1 OF 3		

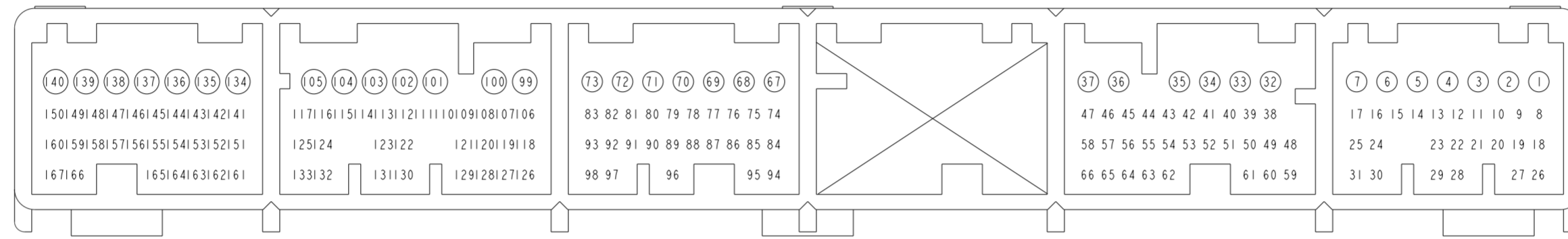

③ FIG 1 CIRCUIT NUMBERS ⑦ ; 040 CONTACT

62	PLASTIC BOX 通い箱	PLASTIC TUBE プラスチックチューブ	SELECTIVE-TIN (MATTE)	SELECTIVE GOLD X 135 SERECTIVE-TIN X 32 (BRIGHT)	99,100	8~31,38~66,74~98, 106~133,141~167	GRAY (灰色)	6318813-6
62	PLASTIC BOX 通い箱	PLASTIC TUBE プラスチックチューブ	SELECTIVE-TIN (MATTE)	SELECTIVE GOLD X 135 SERECTIVE-TIN X 32 (BRIGHT)	99,100	8~31,38~66,74~98, 106~133,141~167	BLACK (黒色)	6318813-2
61	PAPER BOX ダンボール箱	PLASTIC TUBE プラスチックチューブ	SELECTIVE-TIN (MATTE)	SELECTIVE GOLD X 83 SERECTIVE-TIN X 84 (BRIGHT)	99,100	18~31,48~66,84~98, 118~133,151~167	NATURAL (自然色)	6318813-3
61	PLASTIC BOX 通い箱	PLASTIC TUBE プラスチックチューブ	SELECTIVE-TIN (MATTE)	SELECTIVE GOLD X 83 SERECTIVE-TIN X 84 (BRIGHT)	99,100	18~31,48~66,84~98, 118~133,151~167	NATURAL (自然色)	6318813-1
3	PLASTIC BOX 通い箱	PLASTIC TUBE プラスチックチューブ	SELECTIVE-TIN (MATTE)	SELECTIVE-TIN X 167 (BRIGHT)	-	-	NATURAL (自然色)	1318813-7
③ MARKING (マーキング)	OUTER 外表	INNER 内装	SOLDERING SIDE 半田付け部	CONTACT SIDE 接触部側	040TAB	025 TAB	COLOR (色)	PART NUMBER (型番)
	PACKING STYLE 梱包形態		CONTACT FINISH (仕上げ)		③ GOLD PLATED CIRCUIT NO (金めっき回路番号)			

THIS DRAWING IS A CONTROLLED DOCUMENT.

DWN K. FURUYAMA	10FEB2000	 TE Connectivity	NAME 025/040 EFI ECU CONNECTOR 167 POSITION CAP HOUSING ASSEMBLY		
CHK N. SAI	10FEB2000				
APVD N. SAI	10FEB2000				
PRODUCT SPEC 製品規格	SEE 1 OF 3				
APPLIC. SPEC 取付適用規格	SEE 1 OF 3	SIZE	CAGE CODE	DRAWING NO	RESTRICTED TO
MATERIAL 材料	SEE 1 OF 3	A2	00779	G-1318813	-
FINISH 仕上	SEE 1 OF 3	WEIGHT	SEE 1 OF 3	SCALE	SHEET 2 OF 3
CUSTOMER DRAWING		SCALE 1:1		REV E2	

THIS DRAWING IS UNPUBLISHED. RELEASED FOR PUBLICATION 2017
 © COPYRIGHT 2017 ALL RIGHTS RESERVED.

LOC	DIST	REVISIONS					
J	-	P	LTR	DESCRIPTION	DATE	DWN	APVD
				SEE SHEET 1 OF 3			

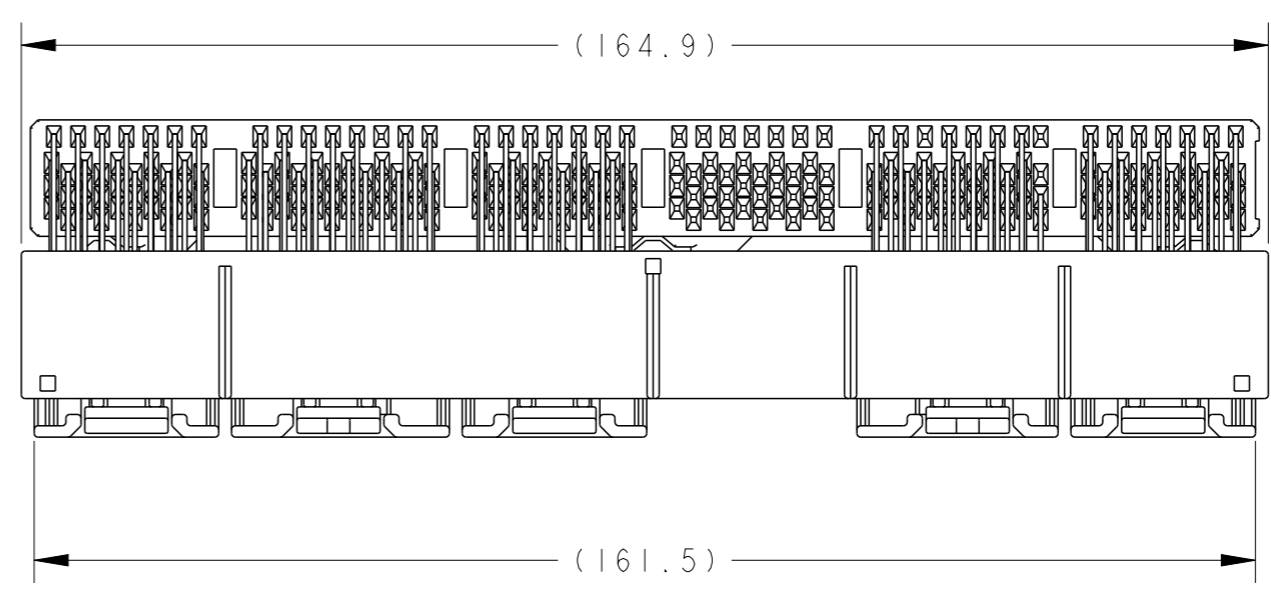
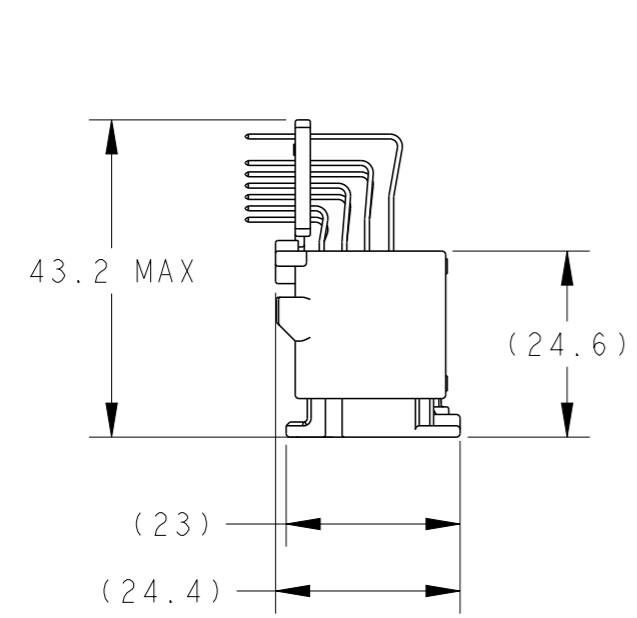

CAP ASSEMBLY & PLUG ASSEMBLY ENGAGEMENT DRAWING
 キャップアッセンブリ & プラグアッセンブリ 嵌合図

TABLE - 1

POSITION 極数	PART NUMBER 型番
34	1123337, 1674925
35	1123338, 1674558
32	1123339, 1674922
35	1123340, 1674928
31	1123341, 1674919

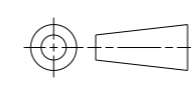
THIS DRAWING IS A CONTROLLED DOCUMENT.		DWN K. FURUYAMA 10FEB2000	 TE Connectivity 025/040 EFI ECU CONNECTOR 167P CAP HOUSING ASSY	RESTRICTED TO
DIMENSIONS: 単位: 耗 mm		CHK N. SAI 10FEB2000		
TOLERANCES UNLESS OTHERWISE SPECIFIED: 一般公差 = ± 0.3		APVD N. SAI 10FEB2000		
 0-PLC ± 1-PLC ±0.5 2-PLC ±0.13 3-PLC ±0.013 4-PLC ±0.000J ANGLES ±3'00"		PRODUCT SPEC SEE 1 OF 3		
MATERIAL 材料	FINISH 仕上	APPLICATION SPEC 取付適用規格 SEE 1 OF 3	SIZE A3	CAGE CODE 00779
SEE 1 OF 3	SEE 1 OF 3	WEIGHT SEE 1 OF 3	DRAWING NO C-1318813	SCALE 尺度 1:1
CUSTOMER DRAWING			SHEET 3 OF 3	REV E2