

GROUNDING PRODUCTS GUIDE

Proper grounding and bonding is critical to the effective operation of all electrified systems: power, telecommunications, and data communications. It is also vital for the protection of people and equipment. The common elements that comprise all grounding systems are conductors, ground electrodes, and connectors. Connectors are traditionally the “weak link” in the grounding network. Connectors vary by application, but for high current permanent grounds, properly engineered and manufactured exothermic connections are the superior technology eliminating that weakness. Exothermic connections have been in use since the 1940s and have been the preferred technology for high fault current (substation) grounding since the 1950s.

TE Connectivity (TE) is pleased to add AMP Weld exothermic grounding products to our existing product line which includes WRENCH-LOK, SHEAR-LOK, and AMPACT copper tap connectors.

TE’s AMP Weld exothermically welded connection system has been successfully tested and qualified to the high standard established in the latest revision of IEEE 837-2014. The IEEE protocol incorporates procedures for two separate evaluations of each grounding connection:

- Mechanical testing which subjects the connection to severe electromechanical forces via the application of extremely high asymmetric test currents.
- Sequential testing which exposes the connection to a series of environments replicating hostile field conditions.

Testing included various combinations and configurations of conductors including:

- Cable-to-cable, cable-to-ground rod and cable-to-structural steel plate
- Tees, parallels and end or straight connections

For more information, reference TE Technical Report: 508-47480

TE is committed to providing our customers with the highest level of service, reliability, and technical expertise in the industry. We want to be your partner of choice.



Table of Contents

I TE's AMP Weld Exothermically Welded Grounding Connections

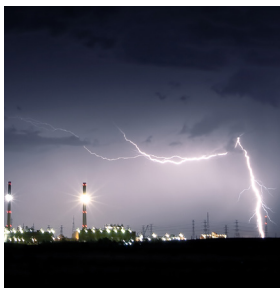

Introduction	14
TE's AMP Weld Mold Part Numbering System	15
Heavy Duty Connections	16
Cable to Cable	
SH	17
PRH	18
PRV.....	19
TE.....	20
PR.....	22
PE.....	23
XN.....	24
XQ.....	25
Cable to Ground Rod	
GE	26
GC.....	27
GC3	28
GC4.....	29
GX.....	30
Welding to Rebar	31
Cable to Rebar	
RTE.....	32
RE.....	33
RXH.....	34
RXV	35
RDE.....	36
Cable to Busbar	
WBE.....	37
WBT	38
WBVD	39
Cable to Lug/Busbar	
LT.....	41
LBT	42
Busbar to Busbar	
BBS.....	43
BBA.....	44

Exothermically
Welded
Grounding
Connections

Table of Contents

I TE's AMP Weld Exothermically Welded Grounding Connections

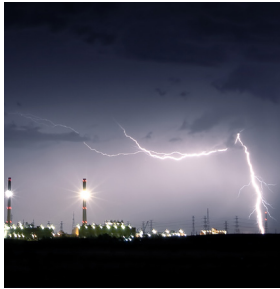

Cable to Horizontal Steel Surface	
HE	45
HE-PIPE	46
HOE	47
HOE-PIPE	48
HR	49
HR-PIPE	50
HOR	51
HOR-PIPE	52
Cable to Vertical Steel Surface	
VAD	53
VAD-PIPE	53
VSD	55
VSD-PIPE	55
VSU	56
VSU-PIPE	56
VSV	57
VSV-PIPE	57
VSH	58
VSH-PIPE	58
VSOH	59
VOSH-PIPE	59
VSL	60
VSL-PIPE	60
VSR	61
VSR-PIPE	61
Materials, Tools and Accessories	
TE'S AMP Weld Premium Weld Material (Metal)	62
TE'S AMP Weld Molds	62
Mold Handle Clamps	62
Chain Handle Clamps	63
Magnetic Handle Clamps	63
C-Clamp	63
Flint Ignitor	64
Torch Head	64
Wrap Sleeve	64
Batting	64

Exothermically
Welded
Grounding
Connections

Table of Contents

I TE's AMP Weld Exothermically Welded Grounding Connections

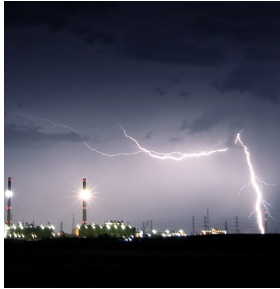

Materials, Tools and Accessories Cont'd

Cable Clamp.....	65
Mold Brush.....	65
Slag Spade.....	65
Wire Brush.....	66
Weld Metal Disks.....	66
Mold Sealer.....	66
Terminal Lugs.....	67
Technical Information.....	68

Exothermically
Welded
Grounding
Connections

II Copper Wire Taps

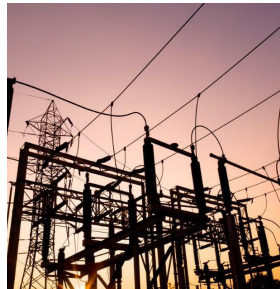

TE's AMPACT Copper Wedge Connectors

Copper Taps.....	74
Tools and Accessories	
AMPACT Tools.....	77
Lead Free Cartridges.....	79
Cleaning Tools.....	79

Copper
Wire
Taps

III

Bolted Wedge Ground Connectors



Grounding Connectors

WRENCH-LOK Connectors.....	82
SHEAR-LOK Connectors.....	86

Bolted
Wedge
Ground
Connectors





Chapter I

TE's AMP Weld Exothermically Welded Grounding Connections

Introduction.....	14
Mold Part Numbering System	15
Heavy Duty Connections.....	16
Cable to Cable	17
Cable to Ground Rod	26
Welding to Rebar.....	31
Cable to Rebar	32
Cable to Busbar	37
Cable to Lug/Busbar.....	41
Busbar to Busbar	43
Cable to Horizontal Steel Surface	45
Cable to Vertical Steel Surface	53
Materials, Tools and Accessories	62
Technical Information	68

TE's AMP Weld Exothermically Welded Connections



TE500-500A



HE4/0-A

TE's AMP Weld exothermic welding process is an aluminothermic chemical reaction between aluminum and copper oxide. In the exothermic reaction the aluminum reduces the copper oxide to produce copper metal (molten), aluminum oxide (slag), and the liberation of a large amount of heat.

The molten copper generated from the reaction is used to fuse conductors together and form an electrical connection. The connections have an ampacity that exceeds that of the conductors being joined. The connection will never increase in resistance and will have a service life that exceeds that of the conductors joined.

This process is utilized to produce permanent electric connections for joining applications such as copper to copper and copper to steel. The primary applications include electrical grounding and bonding where permanent connections are required. The process is also used for power connections. This technology is field-proven to provide the best permanent electrical connection possible.

TE's AMP Weld exothermic welding process is performed using a semi-permanent graphite mold and premium grade exothermic welding material (powder). The welding process is easy to perform on the jobsite and requires no external power source to perform the process. Our exothermic welding material is a proprietary blend of copper oxides, aluminum and alloy elements to produce the highest yield of usable weld metal available in the market. The welding and starting materials are packaged by size in double cavity plastic tubes. The two materials are in separate chambers which ensures there is NEVER intermixing of the welding and starting materials. Steel disks are packaged along with the tubes in plastic boxes. These materials are nonexplosive and are not subject to spontaneous combustion.

Molds are precision engineered and machined to provide superior results in the field. They are produced from high quality graphite and components allowing them to withstand repetitive heat cycles. The minimum life of a mold is 60-70 connections, but if cared for properly can make over 100 connections.

TE's AMP Weld exothermically welded connections are designed to provide complete fusion of the conductors being joined. This is imperative for connections to meet the stringent requirements of IEEE Std 837™-2014, the standard for qualifying permanent connections used in substation grounding. To the left are examples of two metallographic specimens of the molds tested to and passed IEEE Std 837™-2014.

TE's AMP Weld exothermically welded connections meets the requirements of IEEE std. 837-2014.

TE's AMP Weld Mold Part Numbering System

The part numbering system for TE's AMP Weld molds is quite simple and intuitive. Logical conductor designations are used to make for descriptive catalog part numbers. First the connection family is identified for the application, and conductor orientation required. The connection family typically has two characters but in some cases more are used. The Special Feature ID suffix is used for identifying Heavy Duty molds (described next page), molds with wear plates, and specially designed molds per customer request.

The part number structure is shown below:

Connection Family	Run Conductor	Conductor Separator	Tap Conductor	Price Key	Special Feature ID
XX	XX	-	XX	X	X

Special Feature ID's:

- HD Heavy Duty Mold
- W Wear Plates
- xxx Customer Special (three digit number)

EXAMPLES:

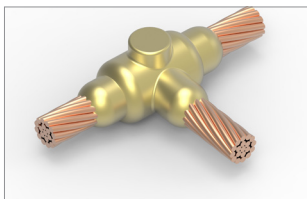

TE250-4/0A
TE (cable to cable Tee):
250 MCM conc Run
with a 4/0 conc Tap

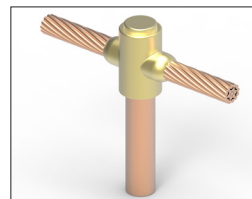

GC2/0-3/4A
GC (cable cross top of
ground rod):
2/0 conc across top of a
3/4" cu-clad steel
ground rod

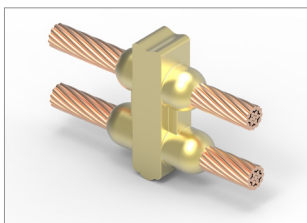

PR250-250B-HD
PR (parallel Run and
Tap cable):
Heavy Duty mold for
250 MCM conc
Run and Tap

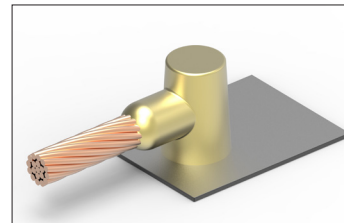

HE750-B
HE (cable termination
on horizontal steel
surface):
750 MCM conc to
horizontal flat steel

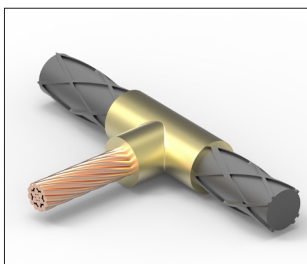

RTE4-1/0A
RTE (cable to rebar Tee):
#4 rebar run with 1/0 conc Tap

TE's AMP Weld exothermically welded connections meets the requirements of IEEE std. 837-2014.

Heavy Duty Connections Recommended for Aged Conductors

Heavy duty connections are used when installing connections onto aged conductors (reclaimed cable) that have been buried or weathered. These connections are designed to use a larger weld material size to provide more thermal energy while not increasing the temperature. The extra thermal energy will burn off any excess oxide build up and contaminants, and not affect the integrity of the resulting connection.

In situations where connections are being installed onto cable that have been in service and exposed to the external environment for an extended period of time, it may be difficult, if not impossible to clean the cable to a like new state to enable normal connections to perform properly. Heavy Duty connections will significantly increase the reliability of connections made under such adverse field conditions.

As heavy duty connections require the use of more weld material as compared to a normal connection, the associated per connection costs will be higher. Contact TE Connectivity for ordering information.

TE's AMP Weld exothermically welded connections meets the requirements of IEEE std. 837-2014.

SH

HORIZONTAL SPLICE CONNECTIONS

- SH makes a straight butt splice.
- Conductors in plane

GENERAL INFORMATION

- Molds shown are for concentric strand AWG conductors.
- Bare Class A, B, and C based on ASTM Standard Specifications
- Solid conductors are designated with a "S" suffix after the conductor
- Mold Price Key is the last letter in the Mold Catalog Number. i.e. A or B.
- For wear plates add the letter W to the end of the Mold Catalog Number

REQUIRED TOOLS

- ♦ Handle Clamps
 - HCLAMP-3 (A Price Key Molds)
 - HCLAMP-4 (B Price Key Molds)
- ♦ Flint Ignitor -FLINT IGNITOR

SUGGESTED TOOLS

- Cable Cleaning Brush -CC-BRUSH
- Slag Removal Spade - SLAG-SPADE
- Mold Cleaning Brush - MC-BRUSH
- Torch Head - EXO-TORCH

Cable Size	Mold Catalog Number	Weld Metal	Mold Price Key
#6 sol	SH6S-6SA	25	A
#6	SH6-6A	25	A
#4 sol	SH4S-4SA	25	A
#4	SH4-4A	25	A
#2 Sol	SH2S-2SA	32	A
#2	SH2-2A	32	A
1/0 sol	SH1/0S-1/0SA	45	A
1/0	SH1/0-1/0A	45	A
2/0	SH2/0-2/0A	65	A
3/0	SH3/0-3/0A	90	A
4/0 sol	SH4/0S-4/0SA	90	A
4/0	SH4/0-4/0A	90	A
250 MCM	SH250-250A	115	A
300 MCM	SH300-300A	115	A
350 MCM	SH350-350A	150	A
500 MCM	SH500-500A	200	A
750 MCM	SH750-750B	2 x 150	B
1000 MCM	SH1000-1000B	2 x 200	B

Contact TE Connectivity for molds with other conductor sizes and configurations.

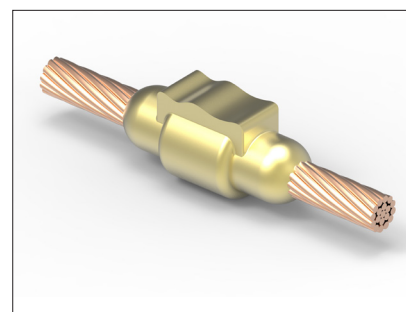

SH

PRH

HORIZONTAL SPLICE CONNECTIONS

- PRH makes a horizontal parallel connection.
- Conductors in plane

GENERAL INFORMATION

- Molds shown are for concentric strand AWG conductors.
- Bare Class A, B, and C based on ASTM Standard Specifications
- Solid conductors are designated with a "S" suffix after the conductor
- Mold Price Key is the last letter in the Mold Catalog Number. i.e. A or B.
- For wear plates add the letter W to the end of the Mold Catalog Number

REQUIRED TOOLS

- ♦ Handle Clamps
- HCLAMP-3 (A Price Key Molds)
- ♦ Flint Ignitor -FLINT IGNITOR

SUGGESTED TOOLS

- Cable Cleaning Brush -CC-BRUSH
- Slag Removal Spade - SLAG-SPADE
- Mold Cleaning Brush - MC-BRUSH
- Torch Head - EXO-TORCH

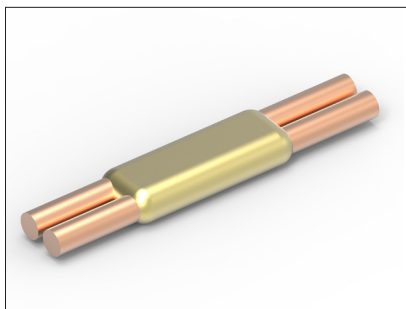

PRH

Cable Size		Mold Catalog Number	Weld Metal	Mold Price Key
Run	Tap			
#8 sol	#8 sol	PRH8S-8SA	25	A
#8	#8	PRH8-8A	25	A
#6 sol	#6 sol	PRH6S-6SA	25	A
#6	#6	PRH6-6A	25	A
#4 sol	#4 sol	PRH4S-4SA	32	A
#4	#4	PRH4-4A	32	A
#2 sol	#2 sol	PRH2S-2SA	45	A

Contact TE Connectivity for molds with other conductor sizes and configurations.

TE's AMP Weld exothermically welded connections meets the requirements of IEEE std. 837-2014.

PRV

PARALLEL VERTICAL CONNECTIONS

- PRV makes a vertical parallel connection
- Conductors in plane

GENERAL INFORMATION

- Molds shown are for concentric strand AWG conductors.
- Bare Class A, B, and C based on ASTM Standard Specifications
- Solid conductors are designated with a "S" suffix after the conductor
- Mold Price Key is the last letter in the Mold Catalog Number. i.e. A or B.
- For wear plates add the letter W to the end of the Mold Catalog Number

REQUIRED TOOLS

- ♦ Handle Clamps
- HCLAMP-3 (A Price Key Molds)
- ♦ Flint Ignitor -FLINT IGNITOR

SUGGESTED TOOLS

- Cable Cleaning Brush -CC-BRUSH
- Slag Removal Spade - SLAG-SPADE
- Mold Cleaning Brush - MC-BRUSH
- Torch Head - EXO-TORCH

Cable Size		Mold Catalog Number	Weld Metal	Mold Price Key
Run	Tap			
#2	#2	PRV2-2A	115	A
1/0	#2	PRV1/0-2A	115	A
	1/0	PRV1/0-1/0A	150	A
2/0	#2	PRV2/0-2A	150	A
	1/0	PRV2/0-1/0A	150	A
	2/0	PRV2/0-2/0A	150	A
3/0	3/0	PRV3/0-3/0A	250	A
4/0	#2	PRV4/0-2A	200	A
	1/0	PRV4/0-1/0A	250	A
	2/0	PRV4/0-2/0A	250	A
	4/0	PRV4/0-4/0A	2 X 200	A
250 MCM	4/0	PRV250-4/0A	2 X 200	A
	250 MCM	PRV250-250A	2 X 200	A

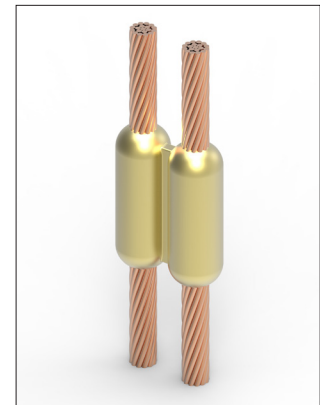

PRV

Contact TE Connectivity for molds with other conductor sizes and configurations.

TE's AMP Weld exothermically welded connections meets the requirements of IEEE std. 837-2014.

TE

HORIZONTAL TEE CONNECTIONS

- TE makes a TEE connection of horizontal Run and Tap conductors.
- Conductors are in the same plane

GENERAL INFORMATION

- Molds shown are for concentric strand AWG conductors.
- Bare Class A, B, and C based on ASTM Standard Specifications
- Solid conductors are designated with a "S" suffix after the conductor
- Mold Price Key is the last letter in the Mold Catalog Number. i.e. A or B.
- For wear plates add the letter W to the end of the Mold Catalog Number

REQUIRED TOOLS

- Handle Clamps
 - HCLAMP-3 (A Price Key Molds)
 - HCLAMP-4 (B Price Key Molds)
- Flint Ignitor -FLINT IGNITOR

SUGGESTED TOOLS

- Cable Cleaning Brush -CC-BRUSH
- Slag Removal Spade - SLAG-SPADE
- Mold Cleaning Brush - MC-BRUSH
- Torch Head - EXO-TORCH

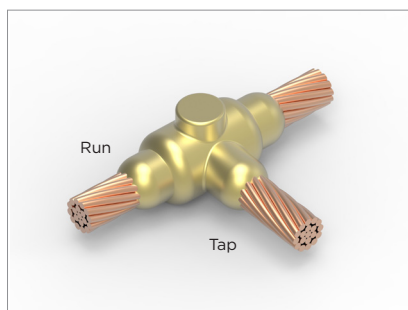

TE

Cable Size		Mold Catalog Number	Weld Metal	Mold Price Key
Run	Tap			
#4	#4	TE4-4A	32	A
#2 Sol	#2 sol	TE2S-2SA	45	A
#2	#6	TE2-6A	45	A
	#4	TE2-4A	45	A
	#2 sol	TE2-2SA	45	A
	#2	TE2-2A	45	A
1/0	#6	TE1/0-6A	45	A
	#4	TE1/0-4A	45	A
	#2 sol	TE1/0-2SA	45	A
	#2	TE1/0-2A	45	A
2/0	1/0	TE1/0-1/0A	90	A
	#6	TE2/0-6A	45	A
	#4	TE2/0-4A	45	A
	#2 sol	TE2/0-2SA	45	A
	#2	TE2/0-2A	45	A
3/0	1/0	TE2/0-1/0A	90	A
	2/0	TE2/0-2/0A	90	A
	#6	TE3/0-6A	45	A
	#4	TE3/0-4A	45	A
	#2 sol	TE3/0-2SA	45	A
	#2	TE3/0-2A	45	A
4/0	1/0	TE3/0-1/0A	90	A
	2/0	TE3/0-2/0A	90	A
	3/0	TE3/0-3/0A	115	A
	#6	TE4/0-6A	90	A
	#4	TE4/0-4A	90	A
	#2 sol	TE4/0-2SA	90	A
	#2	TE4/0-2A	90	A
	1/0	TE4/0-1/0A	90	A
2/0	TE4/0-2/0A	90	A	
3/0	TE4/0-3/0A	115	A	
4/0	TE4/0-4/0A	150	A	

Contact TE Connectivity for molds with other conductor sizes and configurations.

TE's AMP Weld exothermically welded connections meets the requirements of IEEE std. 837-2014.

TE

Cable Size		Mold Catalog Number	Weld Metal	Mold Price Key
Run	Tap			
250 MCM	#2 sol	TE250-2SA	90	A
	#2	TE250-2A	90	A
	1/0	TE250-1/0A	90	A
	2/0	TE250-2/0A	90	A
	3/0	TE250-3/0A	150	A
	4/0	TE250-4/0A	150	A
	250 MCM	TE250-250A	150	A
300 MCM	1/0	TE300-1/0A	90	A
	2/0	TE300-2/0A	90	A
	3/0	TE300-3/0A	150	A
	4/0	TE300-4/0A	150	A
	250 MCM	TE300-250A	150	A
	300 MCM	TE300-300A	200	A
350 MCM	1/0	TE350-1/0A	90	A
	2/0	TE350-2/0A	90	A
	3/0	TE350-3/0A	150	A
	4/0	TE350-4/0A	150	A
	250 MCM	TE350-250A	200	A
	300 MCM	TE350-300A	200	A
	350 MCM	TE350-350A	200	A
500 MCM	1/0	TE500-1/0A	90	A
	2/0	TE500-2/0A	90	A
	4/0	TE500-4/0A	150	A
	250 MCM	TE500-250A	200	A
	300 MCM	TE500-300A	200	A
	350 MCM	TE500-350A	200	A
	500 MCM	TE500-500A	2 X 150	A
750 MCM	1/0	TE750-1/0A	150	A
	2/0	TE750-2/0A	150	A
	4/0	TE750-4/0A	150	A
	250 MCM	TE750-250A	200	A
	300 MCM	TE750-300A	200	A
	350 MCM	TE750-350A	250	A
	500 MCM	TE750-500B	2 x 200	B
	750 MCM	TE750-750B	2 x 250	B
1000 MCM	1/0	TE1000-1/0A	150	A
	2/0	TE1000-2/0A	150	A
	4/0	TE1000-4/0A	150	A
	250 MCM	TE1000-250A	200	A
	300 MCM	TE1000-300A	200	A
	350 MCM	TE1000-350A	250	A
	500 MCM	TE1000-500B	2 x 200	B
	750 MCM	TE1000-750B	2 x 250	B
	1000 MCM	TE1000-1000B	2 x 250	B

Contact TE Connectivity for molds with other conductor sizes and configurations.

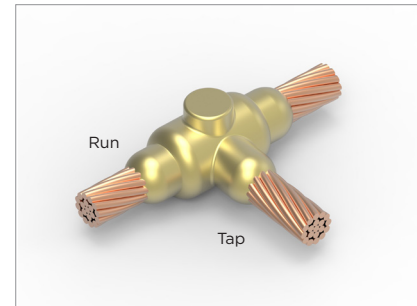

TE

Exothermically
Welded
Grounding
Connections

TE's AMP Weld exothermically welded connections meets the requirements of IEEE std. 837-2014.

PR

PARALLEL HORIZONTAL CONNECTIONS

- PR makes a Parallel through connection of horizontal Run and Tap conductors. Tap conductor positioned over top of the Run conductor

GENERAL INFORMATION:

- Molds shown are for concentric strand AWG conductors.
- Bare Class A, B, and C based on ASTM Standard Specifications
- Solid conductors are designated with a "S" suffix after the conductor
- Mold Price Key is the last letter in the Mold Catalog Number. i.e. A or B.
- For wear plates add the letter W to the end of the Mold Catalog Number

REQUIRED TOOLS

- Handle Clamps
- HCLAMP-3 (A Price Key Molds)
- Flint Ignitor -FLINT IGNITOR

SUGGESTED TOOLS

- Cable Cleaning Brush -CC-BRUSH
- Slag Removal Spade - SLAG-SPADE
- Mold Cleaning Brush - MC-BRUSH
- Torch Head - EXO-TORCH

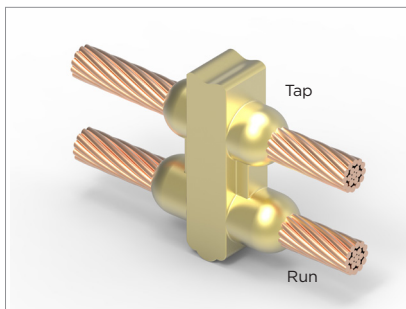

PR

Cable Size		Mold Catalog Number	Weld Metal	Mold Price Key
Run	Tap			
#6 sol	#6 sol	PR6S-6SA	25	A
#6	#6	PR6-6A	25	A
#4	#6 sol	PR4-6SA	32	A
	#6	PR4-6A	32	A
	#4	PR4-4A	32	A
#2 sol	#6 sol	PR2S-6SA	45	A
	#6	PR2S-6A	45	A
	#2 sol	PR2S-2SA	65	A
#2	#6 sol	PR2-6SA	45	A
	#6	PR2-6A	45	A
	#4	PR2-4A	65	A
	#2	PR2-2A	65	A
1/0	#6	PR1/0-6A	65	A
	#4	PR1/0-4A	65	A
	#2 sol	PR1/0-2SA	65	A
	#2	PR1/0-2A	65	A
	1/0	PR1/0-1/0A	90	A
2/0	#6	PR2/0-6A	90	A
	#4	PR2/0-4A	90	A
	#2 sol	PR2/0-2SA	90	A
	#2	PR2/0-2A	90	A
	1/0	PR2/0-1/0A	115	A
	2/0	PR2/0-2/0A	115	A
4/0	#6	PR4/0-6A	90	A
	#4	PR4/0-4A	150	A
	#2 sol	PR4/0-2SA	150	A
	#2	PR4/0-2A	150	A
	1/0	PR4/0-1/0A	150	A
	2/0	PR4/0-2/0A	150	A
	3/0	PR4/0-3/0A	200	A
	4/0	PR4/0-4/0A	200	A
250 MCM	#2 sol	PR250-2SA	150	A
	#2	PR250-2A	150	A
	1/0	PR250-1/0A	150	A
	2/0	PR250-2/0A	150	A
	4/0	PR250-4/0A	200	A
	250 MCM	PR250-250A	250	A

Contact TE Connectivity for molds with other conductor sizes and configurations.

TE's AMP Weld exothermically welded connections meets the requirements of IEEE std. 837-2014.

HORIZONTAL TAP CONNECTIONS

- PE makes a Tap connection of horizontal Run and Tap conductors. Tap conductor positioned over top of the Run conductor

GENERAL INFORMATION:

- Molds shown are for concentric strand AWG conductors.
- Bare Class A, B, and C based on ASTM Standard Specifications
- Solid conductors are designated with a "S" suffix after the conductor
- Mold Price Key is the last letter in the Mold Catalog Number. i.e. A or B.
- For wear plates add the letter W to the end of the Mold Catalog Number

REQUIRED TOOLS

- Handle Clamps
- HCLAMP-3 (A Price Key Molds)
- Flint Ignitor -FLINT IGNITOR

SUGGESTED TOOLS

- Cable Cleaning Brush -CC-BRUSH
- Slag Removal Spade - SLAG-SPADE
- Mold Cleaning Brush - MC-BRUSH
- Torch Head - EXO-TORCH

Cable Size		Mold Catalog Number	Weld Metal	Mold Price Key
Run	Tap			
#6 sol	#6 sol	PE6S-6SA	25	A
#6	#6	PE6-6A	25	A
#4	#6 sol	PE4-6SA	32	A
	#6	PE4-6A	32	A
	#4	PE4-4A	32	A
#2 sol	#6 sol	PE2S-6SA	32	A
	#6	PE2S-6A	32	A
	#2 sol	PE2S-2SA	65	A
#2	#6 sol	PE2-6SA	32	A
	#6	PE2-6A	32	A
	#4	PE2-4A	45	A
	#2	PE2-2A	65	A
1/0	#6	PE1/0-6A	45	A
	#4	PE1/0-4A	65	A
	#2 sol	PE1/0-2SA	65	A
	#2	PE1/0-2A	65	A
	1/0	PE1/0-1/0A	90	A
2/0	#6	PE2/0-6A	65	A
	#4	PE2/0-4A	65	A
	#2 sol	PE2/0-2SA	90	A
	#2	PE2/0-2A	90	A
	1/0	PE2/0-1/0A	115	A
	2/0	PE2/0-2/0A	115	A
4/0	#6	PE4/0-6A	90	A
	#4	PE4/0-4A	90	A
	#2 sol	PE4/0-2SA	115	A
	#2	PE4/0-2A	115	A
	1/0	PE4/0-1/0A	115	A
	2/0	PE4/0-2/0A	115	A
	3/0	PE4/0-3/0A	115	A
	4/0	PE4/0-4/0A	150	A
250 MCM	4/0	PE250-4/0A	200	A
	250 MCM	PE250-250A	250	A

Contact TE Connectivity for molds with other conductor sizes and configurations.

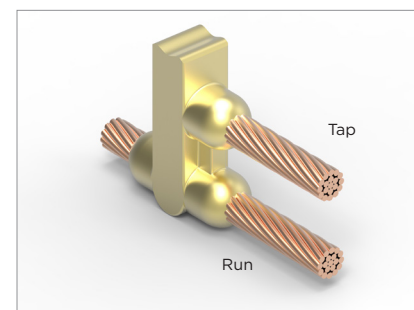

PE

TE's AMP Weld exothermically welded connections meets the requirements of IEEE std. 837-2014.

XN

HORIZONTAL CROSS CONNECTIONS

- XN makes a horizontal cross (X) connection. Tap conductor cut.
- Conductors are in the same plane.

GENERAL INFORMATION:

- Molds shown are for concentric strand AWG conductors.
- Bare Class A, B, and C based on ASTM Standard Specifications
- Solid conductors are designated with a "S" suffix after the conductor
- Mold Price Key is the last letter in the Mold Catalog Number. i.e. A or B.
- For wear plates add the letter W to the end of the Mold Catalog Number

REQUIRED TOOLS

- ♦ Handle Clamps
 - HCLAMP-3 (A Price Key Molds)
 - HCLAMP-4 (B Price Key Molds)
- ♦ Flint Ignitor -FLINT IGNITOR

SUGGESTED TOOLS

- Cable Cleaning Brush -CC-BRUSH
- Slag Removal Spade - SLAG-SPADE
- Mold Cleaning Brush - MC-BRUSH
- Torch Head - EXO-TORCH

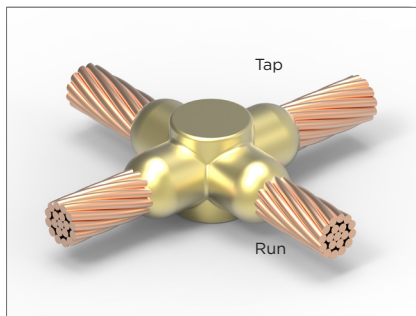

XN

Cable Size		Mold Catalog Number	Weld Metal	Mold Price Key
Run	Tap			
#6 sol	#6 sol	XN6S-6SA	32	A
#6	#6	XN6-6A	32	A
#4	#4	XN4-4A	32	A
#2 sol	#2 sol	XN2S-2SA	65	A
#2	#4	XN2-4A	65	A
	#2	XN2-2A	65	A
1/0	#4	XN1/0-4A	90	A
	#2	XN1/0-2A	90	A
	1/0	XN1/0-1/0A	90	A
2/0	#2	XN2/0-2A	115	A
	1/0	XN2/0-1/0A	115	A
	2/0	XN2/0-2/0A	115	A
3/0	#2	XN3/0-2A	115	A
	1/0	XN3/0-1/0A	115	A
	2/0	XN3/0-2/0A	150	A
4/0	3/0	XN3/0-3/0A	150	A
	#2	XN4/0-2A	115	A
	1/0	XN4/0-1/0A	150	A
	2/0	XN4/0-2/0A	150	A
250 MCM	3/0	XN4/0-3/0A	200	A
	4/0	XN4/0	200	A
	#2	XN250-2A	115	A
	1/0	XN250-1/0A	150	A
	2/0	XN250-2/0A	150	A
300 MCM	3/0	XN250-3/0A	200	A
	4/0	XN250-4/0A	200	A
	250 MCM	XN250-250A	200	A
	#2	XN300-2A	115	A
	1/0	XN300-1/0A	150	A
	2/0	XN300-2/0A	150	A
350 MCM	3/0	XN300-3/0A	200	A
	4/0	XN300-4/0A	200	A
	250 MCM	XN300-250A	250	A
	300 MCM	XN300-300A	250	A
	#2	XN350-2A	150	A
	1/0	XN350-1/0A	200	A
	2/0	XN350-2/0A	200	A
500 MCM	3/0	XN350-3/0A	200	A
	4/0	XN350-4/0A	200	A
	250 MCM	XN350-250A	250	A
	300 MCM	XN350-300A	250	A
	350 MCM	XN350-350A	250	A
	1/0	XN500-1/0A	250	A
	2/0	XN500-2/0A	250	A
	3/0	XN500-3/0B	2 X 150	B
4/0	XN500-4/0B	2 X 150	B	
250 MCM	XN500-250B	2 X 150	B	
300 MCM	XN500-300B	2 X 200	B	
350 MCM	XN500-350B	2 X 200	B	
500 MCM	XN500-500B	2 X 250	B	

Contact TE Connectivity for molds with other conductor sizes and configurations. TE's AMP Weld exothermically welded connections meets the requirements of IEEE std. 837-2014.

HORIZONTAL CROSS CONNECTIONS

- XQ makes a horizontal cross (X) connection. Tap conductor lapped over run and not cut

GENERAL INFORMATION:

- Molds shown are for concentric strand AWG conductors.
- Bare Class A, B, and C based on ASTM Standard Specifications
- Solid conductors are designated with a "S" suffix after the conductor
- Mold Price Key is the last letter in the Mold Catalog Number. i.e. A or B.
- For wear plates add the letter W to the end of the Mold Catalog Number

REQUIRED TOOLS

- ♦ Handle Clamps
 - HCLAMP-3 (A Price Key Molds)
 - HCLAMP-4 (B Price Key Molds)
- ♦ Flint Ignitor -FLINT IGNITOR

SUGGESTED TOOLS

- Cable Cleaning Brush -CC-BRUSH
- Slag Removal Spade - SLAG-SPADE
- Mold Cleaning Brush - MC-BRUSH
- Torch Head - EXO-TORCH

Cable Size		Mold Catalog Number	Weld Metal	Mold Price Key
Run	Tap			
#6 sol	#6 sol	XQ6S-6SA	32	A
#6	#6	XQ6-6A	45	A
#4	#4	XQ4-4A	65	A
#2 sol	#2 sol	XQ2S-2SA	90	A
#2	#4	XQ2-4A	65	A
	#2	XQ2-2A	90	A
1/0	#4	XQ1/0-4A	115	A
	#2	XQ1/0-2A	115	A
	1/0	XQ1/0-1/0A	150	A
2/0	#2	XQ2/0-2A	150	A
	1/0	XQ2/0-1/0A	200	A
	2/0	XQ2/0-2/0A	200	A
3/0	#2	XQ3/0-2A	150	A
	1/0	XQ3/0-1/0A	200	A
	2/0	XQ3/0-2/0A	200	A
	3/0	XQ3/0-3/0A	250	A
4/0	#2	XQ4/0-2A	150	A
	1/0	XQ4/0-1/0A	200	A
	2/0	XQ4/0-2/0A	200	A
	3/0	XQ4/0-3/0A	250	A
	4/0	XQ4/0-4/0A	250	A
250 MCM	#2	XQ250-2A	150	A
	1/0	XQ250-1/0A	250	A
	2/0	XQ250-2/0A	250	A
	3/0	XQ250-3/0B	2 X 150	B
	4/0	XQ250-4/0B	2 X 150	B
300 MCM	250 MCM	XQ250-250B	2 X 150	B
	#2	XQ300-2B	150	B
	1/0	XQ300-1/0B	250	B
	2/0	XQ300-2/0B	2 X 150	B
	3/0	XQ300-3/0B	2 X 150	B
	4/0	XQ300-4/0B	2 X 150	B
	250 MCM	XQ300-250B	2 X 200	B
300 MCM	XQ300-300B	2 X 200	B	
350 MCM	#2	XQ350-2B	200	B
	1/0	XQ350-1/0B	250	B
	2/0	XQ350-2/0B	2 X 150	B
	3/0	XQ350-3/0B	2 X 200	B
	4/0	XQ350-4/0B	2 X 200	B
	250 MCM	XQ350-250B	2 X 250	B
	300 MCM	XQ350-300B	2 X 250	B
350 MCM	XQ350-350B	2 X 250	B	
500 MCM	1/0	XQ500-1/0B	2 X 150	B
	2/0	XQ500-2/0B	2 X 200	B
	3/0	XQ500-3/0B	2 X 250	B
	4/0	XQ500-4/0B	2 X 250	B
	250 MCM	XQ500-250B	2 X 250	B
	300 MCM	XQ500-300B	3 X 200	B
	350 MCM	XQ500-350B	3 X 200	B
	500 MCM	XQ500-500B	3 X 250	B

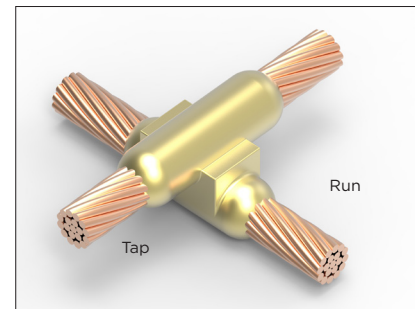

XQ

COPPERWELD*

Cable Size		XQ CONNECTION STYLE	
Run	Tap	Mold Catalog Number	Weld Metal
7/#7	7/#7	XQ7/#7-7/#7A	200
7/#5	7/#5	XQ7/#5-7/#5A	250
19/#9	19/#9	XQ19/#9-19/#9A	2 X 150
19/#8	19/#8	XQ19/#8-19/#8B	2 X 200
19/#7	19/#7	XQ19/#7-19/#7B	2 X 250
19/#6	19/#6	XQ19/#6-19/#6B	3 X 250

COPPERWELD is a trademark of Copperweld Bimetallics, LLC

Contact TE Connectivity for molds with other conductor sizes and configurations.

TE's AMP Weld exothermically welded connections meets the requirements of IEEE std. 837-2014.

GE

CABLE TO GROUND ROD CONNECTIONS

- GE makes a single cable termination to the top of a ground rod

GENERAL INFORMATION

- Molds shown are for concentric strand AWG conductors.
- Bare Class A, B, and C based on ASTM Standard Specifications
- Solid conductors are designated with a "S" suffix after the conductor
- Mold Price Key is the last letter in the Mold Catalog Number. i.e. A or B.
- For wear plates add the letter W to the end of the Mold Catalog Number

REQUIRED TOOLS

- Handle Clamps
- HCLAMP-3 (A Price Key Molds)
- Flint Ignitor -FLINT IGNITOR

SUGGESTED TOOLS

- Cable Cleaning Brush -CC-BRUSH
- Slag Removal Spade - SLAG-SPADE
- Mold Cleaning Brush - MC-BRUSH
- Torch Head - EXO-TORCH

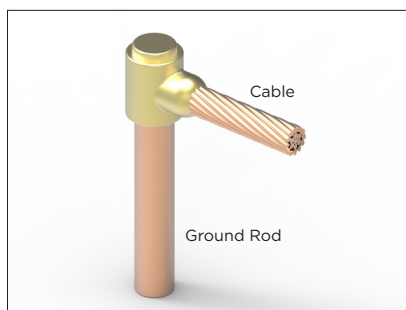

GE

Ground Rod	Cable Size	Mold Catalog Number	Weld Metal	Mold Price Key
1/2 Full size UL Listed	#6 sol	GE1/2-6SA	25	A
	#6	GE1/2-6A	25	A
	#4 sol	GE1/2-4SA	25	A
	#4	GE1/2-4A	25	A
	#2 sol	GE1/2-2SA	32	A
	#2	GE1/2-2A	32	A
	1/0	GE1/2-1/0A	90	A
	2/0	GE1/2-2/0A	90	A
	3/0	GE1/2-3/0A	90	A
	4/0	GE1/2-4/0A	90	A
5/8	250 MCM	GE1/2-250A	90	A
	300 MCM	GE1/2-300A	90	A
	#6 sol	GE5/8-6SA	32	A
	#6	GE5/8-6A	32	A
	#4 sol	GE5/8-4SA	32	A
	#4	GE5/8-4A	32	A
	#2 sol	GE5/8-2SA	65	A
	#2	GE5/8-2A	65	A
	1/0	GE5/8-1/0A	90	A
	2/0	GE5/8-2/0A	90	A
3/4	3/0	GE5/8-3/0A	90	A
	4/0	GE5/8-4/0A	90	A
	250 MCM	GE5/8-250A	90	A
	300 MCM	GE5/8-300A	115	A
	350 MCM	GE5/8-350A	115	A
	500 MCM	GE5/8-500A	150	A
	#6 sol	GE3/4-6SA	32	A
	#6	GE3/4-6A	32	A
	#4 sol	GE3/4-4SA	45	A
	#4	GE3/4-4A	45	A
1	#2 sol	GE3/4-2SA	90	A
	#2	GE3/4-2A	90	A
	1/0	GE3/4-1/0A	90	A
	2/0	GE3/4-2/0A	90	A
	3/0	GE3/4-3/0A	90	A
	4/0	GE3/4-4/0A	90	A
	250 MCM	GE3/4-250A	90	A
	300 MCM	GE3/4-300A	115	A
	350 MCM	GE3/4-350A	115	A
	500 MCM	GE3/4-500A	150	A
750 MCM	GE3/4-750A	250	A	
1	Contact the factory			

Special Note:

- Molds listed in table are for industry standard UL Listed copper-bonded steel ground rods. All are nominal diameters except 1/2 inch which is a full size 1/2 inch ground rod.
- To specify a mold for welding full size copper-bonded steel, galvanized, stainless steel, soild copper ground rods add suffix "F" to the ground rod size. Not necessary for UL Listed (full size) 1/2 inch copper-bonded ground rods.
- For sectional ground rods add the suffix "S" to the ground rod size.

Contact TE Connectivity for molds with other conductor sizes and configurations.

TE's AMP Weld exothermically welded connections meets the requirements of IEEE std. 837-2014.

CABLE TO GROUND ROD CONNECTIONS

- GC makes a through cable connection to the top of a ground rod

GENERAL INFORMATION:

- Molds shown are for concentric strand AWG conductors.
- Bare Class A, B, and C based on ASTM Standard Specifications
- Solid conductors are designated with a "S" suffix after the conductor
- Mold Price Key is the last letter in the Mold Catalog Number. i.e. A or B.
- For wear plates add the letter W to the end of the Mold Catalog Number

REQUIRED TOOLS

- Handle Clamps
 - HCLAMP-3 (A Price Key Molds)
 - HCLAMP-4 (B Price Key Molds)
- Flint Ignitor -FLINT IGNITOR

SUGGESTED TOOLS

- Cable Cleaning Brush -CC-BRUSH
- Slag Removal Spade - SLAG-SPADE
- Mold Cleaning Brush - MC-BRUSH
- Torch Head - EXO-TORCH

Ground Rod	Cable Size	Mold Catalog Number	Weld Metal	Mold Price Key
1/2 Full size UL Listed	#6 sol	GC1/2-6SA	32	A
	#6	GC1/2-6A	32	A
	#4 sol	GC1/2-4SA	32	A
	#4	GC1/2-4A	32	A
	#2 sol	GC1/2-2SA	90	A
	#2	GC1/2-2A	90	A
	1/0	GC1/2-1/0A	90	A
	2/0	GC1/2-2/0A	90	A
	3/0	GC1/2-3/0A	115	A
5/8	4/0	GC1/2-4/0A	115	A
	250 MCM	GC1/2-250A	150	A
	300 MCM	GC1/2-300A	200	A
	#6 sol	GC5/8-6SA	32	A
	#6	GC5/8-6A	32	A
	#4 sol	GC5/8-4SA	32	A
	#4	GC5/8-4A	32	A
	#2 sol	GC5/8-2SA	90	A
	#2	GC5/8-2A	90	A
	1/0	GC5/8-1/0A	115	A
	2/0	GC5/8-2/0A	115	A
	3/0	GC5/8-3/0A	115	A
	4/0	GC5/8-4/0A	115	A
	250 MCM	GC5/8-250A	150	A
	300 MCM	GC5/8-300A	200	A
350 MCM	GC5/8-350A	200	A	
3/4	500 MCM	GC5/8-500A	250	A
	#6 sol	GC3/4-6SA	45	A
	#6	GC3/4-6A	45	A
	#4 sol	GC3/4-4SA	65	A
	#4	GC3/4-4A	65	A
	#2 sol	GC3/4-2SA	90	A
	#2	GC3/4-2A	90	A
	1/0	GC3/4-1/0A	115	A
	2/0	GC3/4-2/0A	115	A
	3/0	GC3/4-3/0A	115	A
	4/0	GC3/4-4/0A	115	A
	250 MCM	GC3/4-250A	150	A
	300 MCM	GC3/4-300A	200	A
	350 MCM	GC3/4-350A	200	A
	500 MCM	GC3/4-500A	250	A
750 MCM	GC3/4-750B	2 X 200	B	
1	Contact the factory			

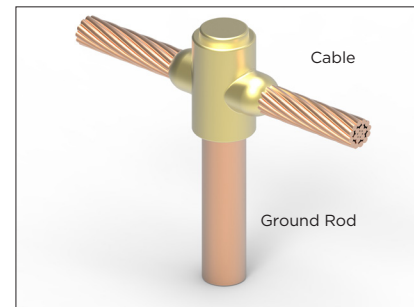

GC

Special Note:

- Molds listed in table are for industry standard UL Listed copper-bonded steel ground rods. All are nominal diameters except 1/2 inch which is a full size 1/2 inch ground rod.

- To specify a mold for welding full size copper-bonded steel, galvanized, stainless steel, solid copper ground rods add suffix "F" to the ground rod size. Not necessary for UL Listed (full size) 1/2 inch copper-bonded ground rods.

- For sectional ground rods add the suffix "S" to the ground rod size.

Contact TE Connectivity for molds with other conductor sizes and configurations.
TE's AMP Weld exothermically welded connections meets the requirements of IEEE std. 837-2014.

GC3

CABLE TO GROUND ROD CONNECTIONS

- GC3 makes a through cable connection and a tap to the top of a ground rod

GENERAL INFORMATION

- Molds shown are for concentric strand AWG conductors.
- Bare Class A, B, and C based on ASTM Standard Specifications
- Solid conductors are designated with a "S" suffix after the conductor
- Mold Price Key is the last letter in the Mold Catalog Number. i.e. A or B.
- For wear plates add the letter W to the end of the Mold Catalog Number

REQUIRED TOOLS

- Handle Clamps
 - HCLAMP-3 (A Price Key Molds)
 - HCLAMP-4 (B Price Key Molds)
- Flint Ignitor -FLINT IGNITOR

SUGGESTED TOOLS

- Cable Cleaning Brush -CC-BRUSH
- Slag Removal Spade - SLAG-SPADE
- Mold Cleaning Brush - MC-BRUSH
- Torch Head - EXO-TORCH

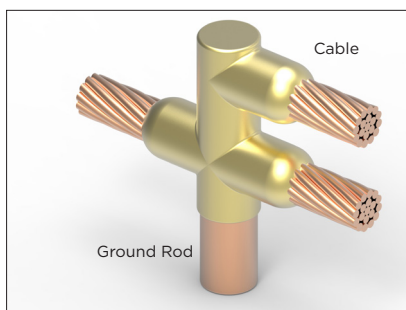

GC3

Special Note:

- Molds listed in table are for industry standard UL Listed copper-bonded steel ground rods. All are nominal diameters except 1/2 inch which is a full size 1/2 inch ground rod.
- To specify a mold for welding full size copper-bonded steel, galvanized, stainless steel, soild copper ground rods add suffix "F" to the ground rod size. Not necessary for UL Listed (full size) 1/2 inch copper-bonded ground rods.
- For sectional ground rods add the suffix "S" to the ground rod size.

Ground Rod	Cable Size	Mold Catalog Number	Weld Metal	Mold Price Key
1/2 Full size UL Listed	#4 sol	GC31/2-4SA	90	A
	#4	GC31/2-4A	90	A
	#2 sol	GC31/2-2SA	90	A
	#2	GC31/2-2A	90	A
	1/0	GC31/2-1/0A	115	A
	2/0	GC31/2-2/0A	150	A
	3/0	GC31/2-3/0A	200	A
	4/0	GC31/2-4/0A	200	A
5/8	#4 sol	GC35/8-4SA	90	A
	#4	GC35/8-4A	90	A
	#2 sol	GC35/8-2SA	115	A
	#2	GC35/8-2A	115	A
	1/0	GC35/8-1/0A	150	A
	2/0	GC35/8-2/0A	200	A
	3/0	GC35/8-3/0A	250	A
	4/0	GC35/8-4/0A	250	A
3/4	250 MCM	GC35/8-250B	2 X 150	B
	#4 sol	GC33/4-4SA	90	A
	#4	GC33/4-4A	90	A
	#2 sol	GC33/4-2SA	115	A
	#2	GC33/4-2A	115	A
	1/0	GC33/4-1/0A	150	A
	2/0	GC33/4-2/0A	200	A
	3/0	GC33/4-3/0A	250	A
	4/0	GC33/4-4/0A	250	A
	250 MCM	GC33/4-250B	2 X 150	B
300 MCM	GC33/4-300B	2 X 200	B	
350 MCM	GC33/4-350B	2 X 200	B	
500 MCM	GC33/4-500B	3 X 200	B	
1	Contact the factory			

Contact TE Connectivity for molds with other conductor sizes and configurations.

TE's AMP Weld exothermically welded connections meets the requirements of IEEE std. 837-2014.

GC4

CABLE TO GROUND ROD CONNECTIONS

- GC4 makes a through cable connection for two cables to the top of a ground rod

GENERAL INFORMATION:

- Molds shown are for concentric strand AWG conductors.
- Bare Class A, B, and C based on ASTM Standard Specifications
- Solid conductors are designated with a "S" suffix after the conductor
- Mold Price Key is the last letter in the Mold Catalog Number. i.e. A or B.
- For wear plates add the letter W to the end of the Mold Catalog Number

REQUIRED TOOLS

- Handle Clamps
 - HCLAMP-3 (A Price Key Molds)
 - HCLAMP-4 (B Price Key Molds)
- Flint Ignitor -FLINT IGNITOR

SUGGESTED TOOLS

- Cable Cleaning Brush -CC-BRUSH
- Slag Removal Spade - SLAG-SPADE
- Mold Cleaning Brush - MC-BRUSH
- Torch Head - EXO-TORCH

Ground Rod	Cable Size	Mold Catalog Number	Weld Metal	Mold Price Key
1/2 Full size UL Listed	#4 sol	GC41/2-4SA	115	A
	#4	GC41/2-4A	115	A
	#2 sol	GC41/2-2SA	115	A
	#2	GC41/2-2A	115	A
	1/0	GC41/2-1/0A	150	A
	2/0	GC41/2-2/0A	200	A
	3/0	GC41/2-3/0A	250	A
5/8	4/0	GC41/2-4/0A	250	A
	#4 sol	GC45/8-4SA	115	A
	#4	GC45/8-4A	115	A
	#2 sol	GC45/8-2SA	150	A
	#2	GC45/8-2A	150	A
	1/0	GC45/8-1/0A	200	A
	2/0	GC45/8-2/0A	250	A
	3/0	GC45/8-3/0B	2 X 150	B
	4/0	GC45/8-4/0B	2 X 150	B
	250 MCM	GC45/8-250B	2 X 200	B
3/4	300 MCM	GC45/8-300B	2 X 250	B
	350 MCM	GC45/8-350B	2 X 250	B
	500 MCM	GC45/8-500B	3 X 250	B
	#4 sol	GC43/4-4SA	115	A
	#4	GC43/4-4A	115	A
	#2 sol	GC43/4-2SA	150	A
	#2	GC43/4-2A	150	A
	1/0	GC43/4-1/0A	200	A
	2/0	GC43/4-2/0A	250	A
	3/0	GC43/4-3/0A	2 X 150	B
1	4/0	GC43/4-4/0A	2 X 150	B
	250 MCM	GC43/4-250B	2 X 200	B
	300 MCM	GC43/4-300B	2 X 250	B
	350 MCM	GC43/4-350B	2 X 250	B
	500 MCM	GC43/4-500B	3 X 250	B
1	Contact the factory			

Contact TE Connectivity for molds with other conductor sizes and configurations.

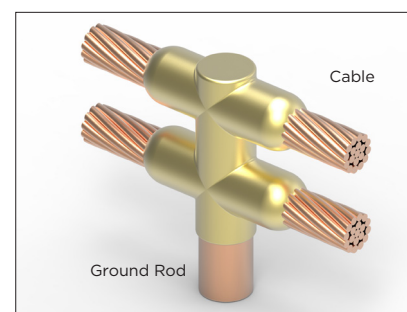

GC4

Special Note:

- Molds listed in table are for industry standard UL Listed copper-bonded steel ground rods. All are nominal diameters except 1/2 inch which is a full size 1/2 inch ground rod.
- To specify a mold for welding full size copper-bonded steel, galvanized, stainless steel, solid copper ground rods add suffix "F" to the ground rod size. Not necessary for UL Listed (full size) 1/2 inch copper-bonded ground rods.
- For sectional ground rods add the suffix "S" to the ground rod size.

TE's AMP Weld exothermically welded connections meets the requirements of IEEE std. 837-2014.

GX

CABLE TO GROUND ROD CONNECTIONS

- GX makes a through cable connection to the side of a ground rod

GENERAL INFORMATION:

- Molds shown are for concentric strand AWG conductors.
- Bare Class A, B, and C based on ASTM Standard Specifications
- Solid conductors are designated with a "S" suffix after the conductor
- Mold Price Key is the last letter in the Mold Catalog Number. i.e. A or B.
- For wear plates add the letter W to the end of the Mold Catalog Number

REQUIRED TOOLS

- Handle Clamps
 - HCLAMP-3 (A Price Key Molds)
 - HCLAMP-4 (B Price Key Molds)
- Flint Ignitor -FLINT IGNITOR

SUGGESTED TOOLS

- Cable Cleaning Brush -CC-BRUSH
- Slag Removal Spade - SLAG-SPADE
- Mold Cleaning Brush - MC-BRUSH
- Torch Head - EXO-TORCH

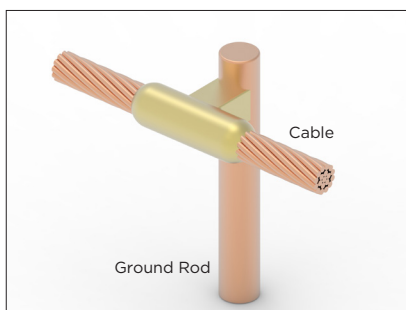

GX

Ground Rod	Cable Size	Mold Catalog Number	Weld Metal	Mold Price Key
1/2 Full size UL Listed	#4 sol	GX1/2-4SA	65	A
	#4	GX1/2-4A	65	A
	#2 sol	GX1/2-2SA	65	A
	#2	GX1/2-2A	65	A
	1/0	GX1/2-1/0A	115	A
	2/0	GX1/2-2/0A	115	A
	3/0	GX1/2-3/0A	150	A
	4/0	GX1/2-4/0A	150	A
	250 MCM	GX1/2-250A	150	A
	300 MCM	GX1/2-300A	200	A
5/8	#4 sol	GX5/8-4SA	65	A
	#4	GX5/8-4A	65	A
	#2 sol	GX5/8-2SA	65	A
	#2	GX5/8-2A	65	A
	1/0	GX5/8-1/0A	115	A
	2/0	GX5/8-2/0A	115	A
	3/0	GX5/8-3/0A	150	A
	4/0	GX5/8-4/0A	150	A
	250 MCM	GX5/8-250A	150	A
	300 MCM	GX5/8-300A	200	A
	350 MCM	GX5/8-350A	250	A
500 MCM	GX5/8-500B	2 X 200	B	
3/4	#4 sol	GX3/4-4SA	65	A
	#4	GX3/4-4A	65	A
	#2 sol	GX3/4-2SA	65	A
	#2	GX3/4-2A	65	A
	1/0	GX3/4-1/0A	115	A
	2/0	GX3/4-2/0A	115	A
	3/0	GX3/4-3/0A	150	A
	4/0	GX3/4-4/0A	150	A
	250 MCM	GX3/4-250A	200	A
	300 MCM	GX3/4-300A	250	A
350 MCM	GX3/4-350A	2 X 150	A	
500 MCM	GX3/4-500B	2 X 250	B	
1	Contact the factory			

Special Note:

- Molds listed in table are for industry standard UL Listed copper-bonded steel ground rods. All are nominal diameters except 1/2 inch which is a full size 1/2 inch ground rod.
- To specify a mold for welding full size copper-bonded steel, galvanized, stainless steel, solid copper ground rods add suffix "F" to the ground rod size. Not necessary for UL Listed (full size) 1/2 inch copper-bonded ground rods.
- For sectional ground rods add the suffix "S" to the ground rod size.

Contact TE Connectivity for molds with other conductor sizes and configurations.

TE's AMP Weld exothermically welded connections meets the requirements of IEEE std. 837-2014.

Welding to Rebar

Rebar Grounding:

TE's AMP Weld exothermically welded connections are ideal for making permanent connections for grounding and lightning protection conductors to reinforcing bar (rebar). TE's AMP Weld provides a permanent connection and guaranteed performance for the lifetime of concrete encased installations. Welding to rebar requires standard materials such as mold, weld metal, handle clamp, and in addition packing material. Packing material can be either copper shim or ceramic batting material and is used to seal the mold to the rebar surface for preventing leakage. The mold selection charts will indicate the packing material required for each mold. To make a proper welded connection, the mill scale must be thoroughly removed from the rebar in the weld area.

Application note:

TE's AMP Weld exothermic welding process is for the sole purpose of welding grounding & lightning conductors to rebar. The process is NOT intended for rebar splicing. Exothermically welding ground conductors to rebar using TE's AMP Weld process will not be harmful if the stresses in the rebar are below its yield point. Normal application limits the design stress for rebar to below 60% of the nominal yield strength, therefore the exothermic welding process should not be detrimental under design stresses. Where practical, locate welds away from areas of maximum tensile stress, near the free end of the rebar.

Lightning Protection note:

For applications where the main lightning protection conductor is connected to the rebar, it is recommended that a 2/0 AWG conductor be used for structures over 75' tall and #2 AWG for structures with heights under 75'. A #6 AWG copper conductor may be used for bonding applications. (NFPA 780)

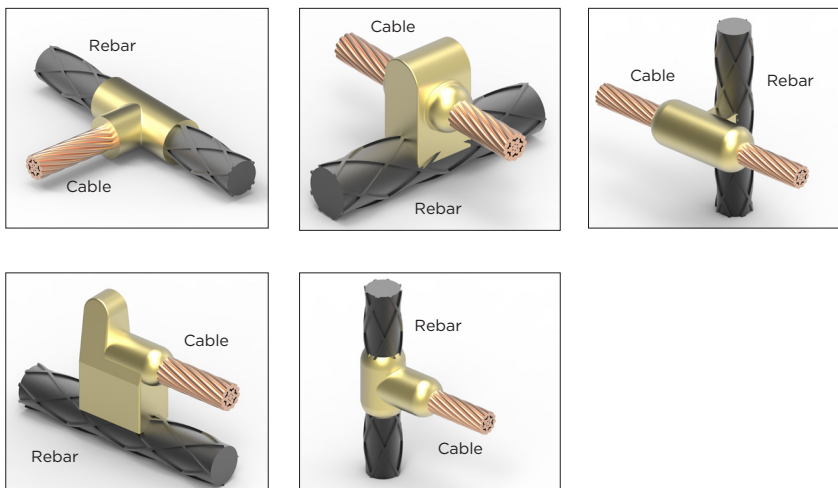

TE's AMP Weld exothermically welded connections meets the requirements of IEEE std. 837-2014.

RTE

CABLE TO HORIZONTAL REBAR CONNECTIONS

- RTE makes a Tee connection of a horizontal tap conductor to the side of a horizontal rebar run.

GENERAL INFORMATION

- Molds shown are for concentric strand AWG conductors.
- Bare Class A, B, and C based on ASTM Standard Specifications
- Solid conductors are designated with a "S" suffix after the conductor
- Mold Price Key is the last letter in the Mold Catalog Number. i.e. A or B.
- For wear plates add the letter W to the end of the Mold Catalog Number

REQUIRED TOOLS

- Handle Clamps
- HCLAMP-3 (A Price Key Molds)
- Packaging Material - CUWRAP
- Flint Ignitor -FLINT IGNITOR

SUGGESTED TOOLS

- Cable Cleaning Brush -CC-BRUSH
- Slag Removal Spade - SLAG-SPADE
- Mold Cleaning Brush - MC-BRUSH
- Torch Head - EXO-TORCH

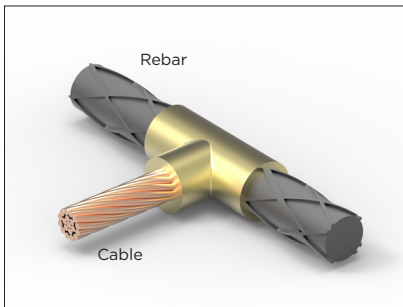

RTE

Rebar Size	Cable Size	Mold Catalog Number	Packing Material	Weld Metal	Mold Price Key
3	#6	RTE3-6A	N/A	45	A
	#4	RTE3-4A	N/A	45	A
	#2 sol	RTE3-2SA	N/A	65	A
	#2	RTE3-2A	N/A	65	A
	1/0	RTE3-1/0A	N/A	90	A
	2/0	RTE3-2/0A	N/A	90	A
	3/0	RTE3-3/0A	N/A	115	A
	4/0	RTE3-4/0A	N/A	115	A
4	#6	RTE4-6A	CUWRAP	45	A
	#4	RTE4-4A	CUWRAP	45	A
	#2 sol	RTE4-2SA	CUWRAP	65	A
	#2	RTE4-2A	CUWRAP	65	A
	1/0	RTE4-1/0A	CUWRAP	90	A
	2/0	RTE4-2/0A	CUWRAP	90	A
	3/0	RTE4-3/0A	CUWRAP	115	A
	4/0	RTE4-4/0A	CUWRAP	115	A
5	#6	RTE5-6A	CUWRAP	90	A
	#4	RTE5-4A	CUWRAP	90	A
	#2 sol	RTE5-2SA	CUWRAP	90	A
	#2	RTE5-2A	CUWRAP	90	A
	1/0	RTE5-1/0A	CUWRAP	115	A
	2/0	RTE5-2/0A	CUWRAP	115	A
	3/0	RTE5-3/0A	CUWRAP	150	A
	4/0	RTE5-4/0A	CUWRAP	150	A
6	#6	RTE6-6A	CUWRAP	90	A
	#4	RTE6-4A	CUWRAP	90	A
	#2 sol	RTE6-2SA	CUWRAP	90	A
	#2	RTE6-2A	CUWRAP	90	A
	1/0	RTE6-1/0A	CUWRAP	115	A
	2/0	RTE6-2/0A	CUWRAP	115	A
	3/0	RTE6-3/0A	CUWRAP	150	A
	4/0	RTE6-4/0A	CUWRAP	150	A

Contact TE Connectivity for molds with other conductor sizes and configurations.

TE's AMP Weld exothermically welded connections meets the requirements of IEEE std. 837-2014.

RE

CABLE TO HORIZONTAL REBAR CONNECTIONS

- RE makes a termination of a horizontal conductor to the top of a horizontal rebar.

GENERAL INFORMATION

- Molds shown are for concentric strand AWG conductors.
- Bare Class A, B, and C based on ASTM Standard Specifications
- Solid conductors are designated with a "S" suffix after the conductor
- Mold Price Key is the last letter in the Mold Catalog Number. i.e. A or B.
- For wear plates add the letter W to the end of the Mold Catalog Number

REQUIRED TOOLS

- Handle Clamps - HCLAMP-3 (A Price Key Molds)
- Packing Material CUWRAP, CBATT-1 or CBATT-2
- Flint Ignitor FLINT-IGNITOR

SUGGESTED TOOLS

- Cable cleaning brush - CC-BRUSH
- Slag removal Spade - SLAG-SPADE
- Mold Cleaning Brush - MC-BRUSH
- Torch Head - EXO-TORCH

Rebar Size	Cable Size	Mold Catalog Number	Packing Material	Weld Metal	Mold Price Key
3	#6	RE3-6A	N/A	25	A
	#4	RE3-4A	N/A	32	A
	#2 sol	RE3-2SA	N/A	45	A
	#2	RE3-2A	N/A	45	A
	1/0	RE3-1/0A	N/A	90	A
	2/0	RE3-2/0A	N/A	90	A
	3/0	RE3-3/0A	N/A	115	A
	4/0	RE3-4/0A	N/A	115	A
4	#6	RE4-6A	CUWRAP	25	A
	#4	RE4-4A	CUWRAP	32	A
	#2 sol	RE4-2SA	CUWRAP	45	A
	#2	RE4-2A	CUWRAP	45	A
	1/0	RE4-1/0A	CUWRAP	90	A
	2/0	RE4-2/0A	CUWRAP	90	A
	3/0	RE4-3/0A	CUWRAP	115	A
	4/0	RE4-4/0A	CUWRAP	115	A
5	#6	RE5-6A	CUWRAP	25	A
	#4	RE5-4A	CUWRAP	32	A
	#2 sol	RE5-2SA	CUWRAP	45	A
	#2	RE5-2A	CUWRAP	45	A
	1/0	RE5-1/0A	CUWRAP	90	A
	2/0	RE5-2/0A	CUWRAP	90	A
	3/0	RE5-3/0A	CUWRAP	115	A
	4/0	RE5-4/0A	CUWRAP	115	A
6 or Larger	#6	RE6U-6A	CBATT-1	25	A
	#4	RE6U-4A	CBATT-1	32	A
	#2 sol	RE6U-2SA	CBATT-1	45	A
	#2	RE6U-2A	CBATT-1	45	A
	1/0	RE6U-1/0A	CBATT-2	90	A
	2/0	RE6U-2/0A	CBATT-2	90	A
	3/0	RE6U-3/0A	CBATT-2	115	A
	4/0	RE6U-4/0A	CBATT-2	115	A

Contact TE Connectivity for molds with other conductor sizes and configurations.

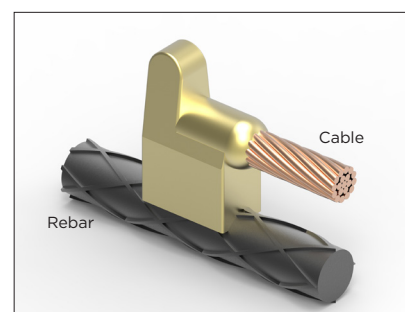

RE

TE's AMP Weld exothermically welded connections meets the requirements of IEEE std. 837-2014.

RXH

CABLE TO HORIZONTAL REBAR CONNECTIONS

- RXH makes a cross (90°) through connection of a horizontal conductor to the top of a horizontal rebar.

GENERAL INFORMATION

- Molds shown are for concentric strand AWG conductors.
- Bare Class A, B, and C based on ASTM Standard Specifications
- Solid conductors are designated with a "S" suffix after the conductor
- Mold Price Key is the last letter in the Mold Catalog Number. i.e. A or B.
- For wear plates add the letter W to the end of the Mold Catalog Number

REQUIRED TOOLS

- Handle Clamps
 - HCLAMP-3 (A Price Key Molds)
- Packing Material CUWRAP, CBATT-1 or CBATT-2
- Flint Ignitor FLINT-IGNITOR

SUGGESTED TOOLS

- Cable cleaning brush - CC-BRUSH
- Slag removal Spade - SLAG-SPADE
- Mold Cleaning Brush - MC-BRUSH
- Torch Head - EXO-TORCH

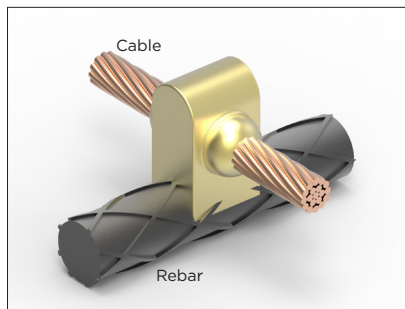

RXH

Rebar Size	Cable Size	Mold Catalog Number	Packing Material	Weld Metal	Mold Price Key
3	#6	RXH3-6A	CUWRAP	65	A
	#4	RXH3-4A	CUWRAP	65	A
	#2 sol	RXH3-2SA	CUWRAP	90	A
	#2	RXH3-2A	CUWRAP	90	A
	1/0	RXH3-1/0A	CUWRAP	115	A
	2/0	RXH3-2/0A	CUWRAP	115	A
	3/0	RXH3-3/0A	CUWRAP	150	A
	4/0	RXH3-4/0A	CUWRAP	150	A
4	#6	RXH4-6A	CUWRAP	65	A
	#4	RXH4-4A	CUWRAP	65	A
	#2 sol	RXH4-2SA	CUWRAP	90	A
	#2	RXH4-2A	CUWRAP	90	A
	1/0	RXH4-1/0A	CUWRAP	115	A
	2/0	RXH4-2/0A	CUWRAP	115	A
	3/0	RXH4-3/0A	CUWRAP	150	A
	4/0	RXH4-4/0A	CUWRAP	150	A
5	#6	RXH5-6A	CUWRAP	65	A
	#4	RXH5-4A	CUWRAP	65	A
	#2 sol	RXH5-2SA	CUWRAP	90	A
	#2	RXH5-2A	CUWRAP	90	A
	1/0	RXH5-1/0A	CUWRAP	115	A
	2/0	RXH5-2/0A	CUWRAP	115	A
	3/0	RXH5-3/0A	CUWRAP	150	A
	4/0	RXH5-4/0A	CUWRAP	150	A
6 or Larger	#6	RXH6U-6A	CBATT-1	65	A
	#4	RXH6U-4A	CBATT-1	65	A
	#2 sol	RXH6U-2SA	CBATT-1	90	A
	#2	RXH6U-2A	CBATT-1	90	A
	1/0	RXH6U-1/0A	CBATT-2	115	A
	2/0	RXH6U-2/0A	CBATT-2	115	A
	3/0	RXH6U-3/0A	CBATT-2	150	A
	4/0	RXH6U-4/0A	CBATT-2	150	A

Contact TE Connectivity for molds with other conductor sizes and configurations.

TE's AMP Weld exothermically welded connections meets the requirements of IEEE std. 837-2014.

RXV

CABLE TO VERTICAL REBAR CONNECTIONS

- RXV makes a cross (90°) through connection of a horizontal conductor to the side of a vertical rebar

GENERAL INFORMATION

- Molds shown are for concentric strand AWG conductors.
- Bare Class A, B, and C based on ASTM Standard Specifications
- Solid conductors are designated with a "S" suffix after the conductor
- Mold Price Key is the last letter in the Mold Catalog Number. i.e. A or B.
- For wear plates add the letter W to the end of the Mold Catalog Number

REQUIRED TOOLS

- Handle Clamps - HCLAMP-3 (A Price Key Molds)
- Packing Material CUWRAP or CBATT-3
- Flint Ignitor FLINT-IGNITOR

SUGGESTED TOOLS

- Cable cleaning brush - CC-BRUSH
- Slag removal Spade - SLAG-SPADE
- Mold Cleaning Brush - MC-BRUSH
- Torch Head - EXO-TORCH

Rebar Size	Cable Size	Mold Catalog Number	Packing Material	Weld Metal	Mold Price Key
3	#6	RXV3-6A	CUWRAP	90	A
	#4	RXV3-4A	CUWRAP	90	A
	#2 sol	RXV3-2SA	CUWRAP	90	A
	#2	RXV3-2A	CUWRAP	90	A
	1/0	RXV3-1/0A	CUWRAP	115	A
	2/0	RXV3-2/0A	CUWRAP	115	A
	3/0	RXV3-3/0A	CUWRAP	150	A
	4/0	RXV3-4/0A	CUWRAP	150	A
4	#6	RXV4-6A	CUWRAP	90	A
	#4	RXV4-4A	CUWRAP	90	A
	#2 sol	RXV4-2SA	CUWRAP	90	A
	#2	RXV4-2A	CUWRAP	90	A
	1/0	RXV4-1/0A	CUWRAP	115	A
	2/0	RXV4-2/0A	CUWRAP	115	A
	3/0	RXV4-3/0A	CUWRAP	150	A
	4/0	RXV4-4/0A	CUWRAP	150	A
5	#6	RXV5-6A	CUWRAP	90	A
	#4	RXV5-4A	CUWRAP	90	A
	#2 sol	RXV5-2SA	CUWRAP	90	A
	#2	RXV5-2A	CUWRAP	90	A
	1/0	RXV5-1/0A	CUWRAP	115	A
	2/0	RXV5-2/0A	CUWRAP	115	A
	3/0	RXV5-3/0A	CUWRAP	150	A
	4/0	RXV5-4/0A	CUWRAP	150	A
6	#6	RXV6-6A	CUWRAP	90	A
	#4	RXV6-4A	CUWRAP	90	A
	#2 sol	RXV6-2SA	CUWRAP	90	A
	#2	RXV6-2A	CUWRAP	90	A
	1/0	RXV6-1/0A	CUWRAP	115	A
	2/0	RXV6-2/0A	CUWRAP	115	A
	3/0	RXV6-3/0A	CUWRAP	150	A
	4/0	RXV6-4/0A	CUWRAP	150	A
7 or Larger**	#6	RXV7U-6A	CBATT-3	90	A
	#4	RXV7U-4A	CBATT-3	90	A
	#2 sol	RXV7U-2SA	CBATT-3	90	A
	#2	RXV7U-2A	CBATT-3	90	A
	1/0	RXV7U-1/0A	CBATT-3	115	A
	2/0	RXV7U-2/0A	CBATT-3	115	A
	3/0	RXV7U-3/0A	CBATT-3	150	A
	4/0	RXV7U-4/0A	CBATT-3	150	A

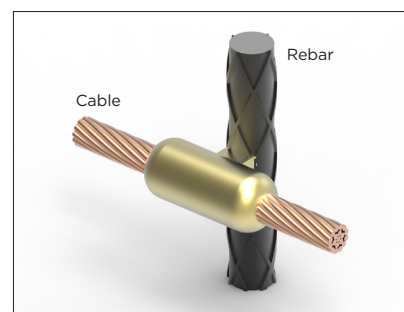

RXV

** Chain Clamp - CHCLAMP-3V (A Price Key Molds) required for #7 & Larger Rebar

Contact TE Connectivity for molds with other conductor sizes and configurations.
TE's AMP Weld exothermically welded connections meets the requirements of IEEE std. 837-2014.

RDE

CABLE TO VERTICAL REBAR CONNECTIONS

- RDE makes a TEE connection of a horizontal Tap conductor to the side of a vertical rebar Run.

GENERAL INFORMATION

- Molds shown are for concentric strand AWG conductors.
- Bare Class A, B, and C based on ASTM Standard Specifications
- Solid conductors are designated with a "S" suffix after the conductor
- Mold Price Key is the last letter in the Mold Catalog Number. i.e. A or B.
- For wear plates add the letter W to the end of the Mold Catalog Number

REQUIRED TOOLS

- Handle Clamps
 - HCLAMP-3 (A Price Key Molds)
- Packing Material CUWRAP or CBATT-3
- Flint Ignitor FLINT-IGNITOR

SUGGESTED TOOLS

- Cable cleaning brush - CC-BRUSH
- Slag removal Spade - SLAG-SPADE
- Mold Cleaning Brush - MC-BRUSH
- Torch Head - EXO-TORCH

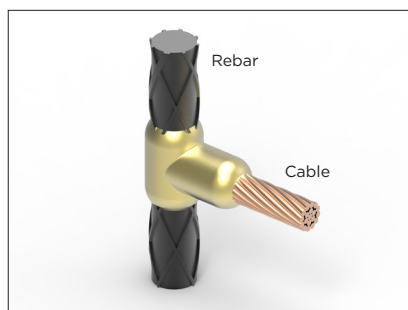

RDE

Rebar Size	Cable Size	Mold Catalog Number	Packing Material	Weld Metal	Mold Price Key
3	#6	RDE3-6A	CUWRAP	65	A
	#4	RDE3-4A	CUWRAP	65	A
	#2 sol	RDE3-2SA	CUWRAP	90	A
	#2	RDE3-2A	CUWRAP	90	A
	1/0	RDE3-1/0A	CUWRAP	115	A
	2/0	RDE3-2/0A	CUWRAP	115	A
	3/0	RDE3-3/0A	CUWRAP	150	A
4	#6	RDE4-6A	CUWRAP	65	A
	#4	RDE4-4A	CUWRAP	65	A
	#2 sol	RDE4-2SA	CUWRAP	90	A
	#2	RDE4-2A	CUWRAP	90	A
	1/0	RDE4-1/0A	CUWRAP	115	A
	2/0	RDE4-2/0A	CUWRAP	115	A
	3/0	RDE4-3/0A	CUWRAP	150	A
5	#6	RDE5-6A	CUWRAP	65	A
	#4	RDE5-4A	CUWRAP	65	A
	#2 sol	RDE5-2SA	CUWRAP	90	A
	#2	RDE5-2A	CUWRAP	90	A
	1/0	RDE5-1/0A	CUWRAP	115	A
	2/0	RDE5-2/0A	CUWRAP	115	A
	3/0	RDE5-3/0A	CUWRAP	150	A
6	#6	RDE6-6A	CUWRAP	65	A
	#4	RDE6-4A	CUWRAP	65	A
	#2 sol	RDE6-2SA	CUWRAP	90	A
	#2	RDE6-2A	CUWRAP	90	A
	1/0	RDE6-1/0A	CUWRAP	115	A
	2/0	RDE6-2/0A	CUWRAP	115	A
	3/0	RDE6-3/0A	CUWRAP	150	A
7 or Larger	#6	RDE7U-6A	CBATT-3	65	A
	#4	RDE7U-4A	CBATT-3	65	A
	#2 sol	RDE7U-2SA	CBATT-3	90	A
	#2	RDE7U-2A	CBATT-3	90	A
	1/0	RDE7U-1/0A	CBATT-3	115	A
	2/0	RDE7U-2/0A	CBATT-3	115	A
	3/0	RDE7U-3/0A	CBATT-3	150	A
	4/0	RDE7U-4/0A	CBATT-3	150	A

Contact TE Connectivity for molds with other conductor sizes and configurations.

TE's AMP Weld exothermically welded connections meets the requirements of IEEE std. 837-2014.

CABLE TO BUSBAR CONNECTIONS

- WBE makes a single cable tap to edge of a horizontal busbar.
- Cable and busbar in horizontal plane.

GENERAL INFORMATION:

- Molds shown are for concentric strand AWG conductors.
- Bare Class A, B, and C based on ASTM Standard Specifications
- Solid conductors are designated with a "S" suffix after the conductor
- Mold Price Key is the last letter in the Mold Catalog Number. i.e. A or B.
- For wear plates add the letter W to the end of the Mold Catalog Number

REQUIRED TOOLS

- Handle Clamps
 - HCLAMP-3 (A Price Key Molds)
 - HCLAMP-4 (B Price Key Molds)
- Flint Ignitor -FLINT IGNITOR

SUGGESTED TOOLS

- Cable Cleaning Brush -CC-BRUSH
- Slag Removal Spade - SLAG-SPADE
- Mold Cleaning Brush - MC-BRUSH
- Torch Head - EXO-TORCH

Bus Size (in)	Cable Size	Mold Catalog Number	Weld Metal	Mold Price Key
1/4 x 1 1/2 & Wider	#6	WBE6-1/4X1.5A	65	A
	#2 sol	WBE2S-1/4X1.5A	65	A
	#2	WBE2-1/4X1.5A	65	A
	1/0	WBE1/0-1/4X1.5A	90	A
	2/0	WBE2/0-1/4X1.5A	90	A
	3/0	WBE3/0-1/4X1.5A	90	A
	4/0	WBE4/0-1/4X1.5A	90	A
	250 MCM	WBE250-1/4X1.5A	115	A
	300 MCM	WBE300-1/4X1.5A	115	A
	350 MCM	WBE350-1/4X1.5A	150	A
500 MCM	WBE500-1/4X1.5A	200	A	
3/8 x 1 1/2 & Wider	#2 sol	WBE2S-3/8X1.5A	65	A
	#2	WBE2-3/8X1.5A	65	A
	1/0	WBE1/0-3/8X1.5A	90	A
	2/0	WBE2/0-3/8X1.5A	90	A
	3/0	WBE3/0-3/8X1.5A	115	A
	4/0	WBE4/0-3/8X1.5A	115	A
	250 MCM	WBE250-3/8X1.5A	150	A
	300 MCM	WBE300-3/8X1.5A	150	A
	350 MCM	WBE350-3/8X1.5A	200	A
	500 MCM	WBE500-3/8X1.5A	250	A
750 MCM	WBE750-3/8X1.5B	2 X 150	B	
1000 MCM	WBE1000-3/8X1.5B	2 X 200	B	
1/2 x 1 1/2 & Wider	#2 sol	WBE2S-1/2X1.5A	90	A
	#2	WBE2-1/2X1.5A	90	A
	1/0	WBE1/0-1/2X1.5A	115	A
	2/0	WBE2/0-1/2X1.5A	115	A
	3/0	WBE3/0-1/2X1.5A	150	A
	4/0	WBE4/0-1/2X1.5A	150	A
	250 MCM	WBE250-1/2X1.5A	200	A
	300 MCM	WBE300-1/2X1.5A	200	A
	350 MCM	WBE350-1/2X1.5A	250	A
	500 MCM	WBE500-1/2X1.5B	2 x 150	B
750 MCM	WBE7500-1/2X1.5B	2 x 200	B	
1000 MCM	WBE7500-1/2X1.5B	2 x 250	B	

Contact TE Connectivity for molds with other conductor sizes and configurations.

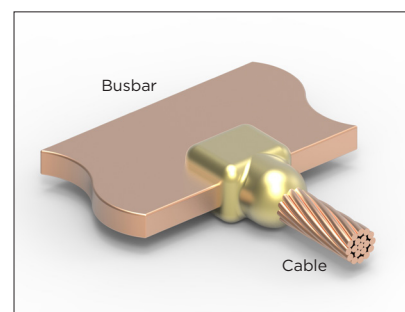

WBE

TE's AMP Weld exothermically welded connections meets the requirements of IEEE std. 837-2014.

WBT

CABLE TO BUSBAR CONNECTIONS

- WBT makes a single busbar Tap (TEE) to a Run conductor. Cable and busbar in horizontal plane.

GENERAL INFORMATION:

- Molds shown are for concentric strand AWG conductors.
- Bare Class A, B, and C based on ASTM Standard Specifications
- Solid conductors are designated with a "S" suffix after the conductor
- Mold Price Key is the last letter in the Mold Catalog Number. i.e. A or B.
- For wear plates add the letter W to the end of the Mold Catalog Number

REQUIRED TOOLS

- Handle Clamps
 - HCLAMP-3 (A Price Key Molds)
 - HCLAMP-4 (B Price Key Molds)
- Flint Ignitor -FLINT IGNITOR

SUGGESTED TOOLS

- Cable Cleaning Brush -CC-BRUSH
- Slag Removal Spade - SLAG-SPADE
- Mold Cleaning Brush - MC-BRUSH
- Torch Head - EXO-TORCH

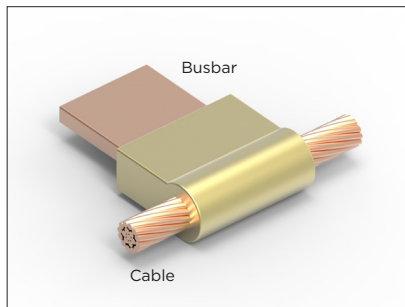

WBT

Bus Size (in)	Cable Size	Mold Catalog Number	Weld Metal	Mold Price Key
1/8 x 1	1/0	WBT1/0-1/8X1A	65	A
	2/0	WBT2/0-1/8X1A	90	A
1/4 x 1	1/0	WBT1/0-1/4X1A	90	A
	2/0	WBT2/0-1/4X1A	115	A
	4/0	WBT4/0-1/4X1A	150	A
	250 MCM	WBT250-1/4X1A	150	A
	300 MCM	WBT300-1/4X1A	200	A
	350 MCM	WBT350-1/4X1A	200	A
1/4 x 1 1/2	500 MCM	WBT500-1/4X1A	250	A
	4/0	WBT4/0-1/4X1.5A	200	A
	250 MCM	WBT250-1/4X1.5A	200	A
	300 MCM	WBT300-1/4X1.5A	250	A
	350 MCM	WBT350-1/4X1.5A	250	A
1/4 x 2	500 MCM	WBT500-1/4X1.5A	2 X 150	B
	4/0	WBT4/0-1/4X2A	250	A
	250 MCM	WBT250-1/4X2A	250	A
	300 MCM	WBT300-1/4X2A	2 X 150	B
	350 MCM	WBT350-1/4X2A	2 X 150	B
	500 MCM	WBT500-1/4X2A	2 X 200	B

Contact TE Connectivity for molds with other conductor sizes and configurations.

TE's AMP Weld exothermically welded connections meets the requirements of IEEE std. 837-2014.

WBVD

CABLE TO BUSBAR CONNECTIONS

- WBVD makes a single cable tap to the top edge of horizontal busbar with face in the vertical plane. Cable is on surface of busbar and oriented vertically downward.

GENERAL INFORMATION

- Molds shown are for concentric strand AWG conductors.
- Bare Class A, B, and C based on ASTM Standard Specifications
- Solid conductors are designated with a "S" suffix after the conductor
- Mold Price Key is the last letter in the Mold Catalog Number. i.e. A or B.
- For wear plates add the letter W to the end of the Mold Catalog Number

REQUIRED TOOLS

- Handle Clamps
 - HCLAMP-3 (A Price Key Molds)
 - HCLAMP-4 (B Price Key Molds)
- Flint Ignitor -FLINT IGNITOR

SUGGESTED TOOLS

- Cable Cleaning Brush -CC-BRUSH
- Slag Removal Spade - SLAG-SPADE
- Mold Cleaning Brush - MC-BRUSH
- Torch Head - EXO-TORCH

Bus Size (in)	Cable Size	Mold Catalog Number	Weld Metal	Mold Price Key
1/8 x 1	1/0	WBVD1/0-1/8X1A	90	A
	2/0	WBVD2/0-1/8X1A	90	A
	4/0	WBVD4/0-1/8X1A	115	A
1/8 X 2	1/0	WBVD1/0-1/8X2A	90	A
	2/0	WBVD2/0-1/8X2A	90	A
	4/0	WBVD4/0-1/8X2A	115	A
	250 MCM	WBVD250-1/8X2A	115	A
1/4 x 1	1/0	WBVD1/0-1/4X1A	115	A
	2/0	WBVD2/0-1/4X1A	115	A
	4/0	WBVD4/0-1/4X1A	150	A
	250 MCM	WBVD250-1/4X1A	150	A
1/4 x 2	300 MCM	WBVD300-1/4X1A	200	A
	1/0	WBVD1/0-1/4X2A	115	A
	2/0	WBVD2/0-1/4X2A	115	A
	4/0	WBVD4/0-1/4X2A	150	A
	250 MCM	WBVD250-1/4X2A	150	A
1/4 x 3 & Wider	300 MCM	WBVD300-1/4X2A	200	A
	350 MCM	WBVD350-1/4X2A	200	A
	500 MCM	WBVD500-1/4X2A	250	A
	1/0	WBVD1/0-1/4X3A	115	A
	2/0	WBVD2/0-1/4X3A	115	A
	4/0	WBVD4/0-1/4X3A	150	A
3/8 x 2	250 MCM	WBVD250-1/4X3A	150	A
	300 MCM	WBVD300-1/4X3A	200	A
	350 MCM	WBVD350-1/4X3A	200	A
	500 MCM	WBVD500-1/4X3A	250	A
	750 MCM	WBVD750-1/4X3B	2 X 200	B
	1/0	WBVD1/0-3/8X2A	115	A
	2/0	WBVD2/0-3/8X2A	115	A
	4/0	WBVD4/0-3/8X2A	150	A
3/8 x 3 & Wider	250 MCM	WBVD250-3/8X2A	150	A
	300 MCM	WBVD300-3/8X2A	200	A
	350 MCM	WBVD350-3/8X2A	200	A
	500 MCM	WBVD500-3/8X2A	250	A
	750 MCM	WBVD750-3/8X2B	2 X 200	B
	1/0	WBVD1/0-3/8X3A	115	A
	2/0	WBVD2/0-3/8X3A	115	A
3/8 x 3 & Wider	4/0	WBVD4/0-3/8X3A	150	A
	250 MCM	WBVD250-3/8X3A	150	A
	300 MCM	WBVD300-3/8X3A	200	A
	350 MCM	WBVD350-3/8X3A	200	A
	500 MCM	WBVD500-3/8X3A	250	A
750 MCM	WBVD750-3/8X3B	2 X 200	B	

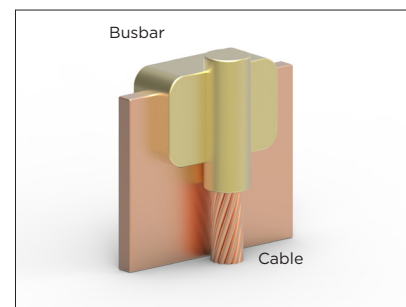

WBVD

Contact TE Connectivity for molds with other conductor sizes and configurations.
TE's AMP Weld exothermically welded connections meets the requirements of IEEE std. 837-2014.

WBVD

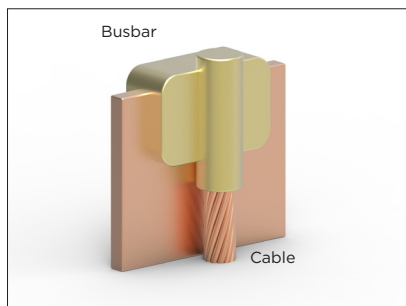

WBVD

Bus Size (in)	Cable Size	Mold Cat Number	Weld Metal	Mold Price Key
1/2 x 2	1/0	WBVD1/0-1/2X2A	150	A
	2/0	WBVD2/0-1/2X2A	150	A
	4/0	WBVD4/0-1/2X2A	200	A
	250 MCM	WBVD250-1/2X2A	200	A
	300 MCM	WBVD300-1/2X2A	250	A
	350 MCM	WBVD350-1/2X2A	250	A
	500 MCM	WBVD500-1/2X2B	2 X 150	B
1/2 x 3 & Wider	750 MCM	WBVD750-1/2X2B	2 X 250	B
	1/0	WBVD1/0-1/2X3A	150	A
	2/0	WBVD2/0-1/2X3A	150	A
	4/0	WBVD4/0-1/2X3A	200	A
	250 MCM	WBVD250-1/2X3A	200	A
	300 MCM	WBVD300-1/2X3A	250	A
	350 MCM	WBVD350-1/2X3A	250	A
	500 MCM	WBVD500-1/2X3A	2 X 150	A
750 MCM	WBVD750-1/2X3B	2 X 250	B	

Contact TE Connectivity for molds with other conductor sizes and configurations.

TE's AMP Weld exothermically welded connections meets the requirements of IEEE std. 837-2014.

CABLE TO LUG/BUSBAR CONNECTIONS

- LT makes straight termination with a straight lug or busbar end

GENERAL INFORMATION

- Molds shown are for concentric strand AWG conductors.
- Bare Class A, B, and C based on ASTM Standard Specifications
- Solid conductors are designated with a "S" suffix after the conductor
- Mold Price Key is the last letter in the Mold Catalog Number. i.e. A or B.
- For wear plates add the letter W to the end of the Mold Catalog Number

REQUIRED TOOLS

- Handle Clamps
 - HCLAMP-3 (A Price Key Molds)
 - HCLAMP-4 (B Price Key Molds)
- Flint Ignitor -FLINT IGNITOR

SUGGESTED TOOLS

- Cable Cleaning Brush -CC-BRUSH
- Slag Removal Spade - SLAG-SPADE
- Mold Cleaning Brush - MC-BRUSH
- Torch Head - EXO-TORCH

Cable Size	Bus/Lug Size (in)	Mold Catalog Number	Weld Metal	Mold Price Key
#6	1/8 x 1	LT6-1/8X1A	45	A
#4	1/8 x 1	LT4-1/8X1A	45	A
#2 sol	1/8 x 1	LT2S-1/8X1A	45	A
#2	1/8 x 1	LT2-1/8X1A	45	A
1/0	1/8 x 1	LT1/0-1/8X1A	45	A
	3/16 x 1	LT1/0-3/16X1A	65	A
	1/4 x 1	LT1/0-1/4X1A	65	A
2/0	1/8 x 1	LT2/0-1/8X1A	65	A
	3/16 x 1	LT2/0-3/16X1A	65	A
	1/4 x 1	LT2/0-1/4X1A	65	A
3/0	1/8 x 1	LT3/0-1/8X1A	65	A
	3/16 x 1	LT3/0-3/16X1A	90	A
	1/4 x 1	LT3/0-1/4X1A	90	A
4/0	3/16 x 1	LT4/0-3/16X1A	90	A
	1/4 x 1	LT4/0-1/4X1A	90	A
	1/4 x 1-1/4	LT4/0-1/4X1.25A	90	A
	1/4 x 1-1/2	LT4/0-1/4X1.5A	90	A
	1/4 x 2	LT4/0-1/4X2A	90	A
	1/4 x 3	LT4/0-1/4X3A	90	A
250 MCM	3/16 x 1	LT250-3/16X1A	90	A
	1/4 x 1	LT250-1/4X1A	90	A
	1/4 x 1-1/4	LT250-1/4X1.25A	90	A
	1/4 x 1-1/2	LT250-1/4X1.5A	90	A
	1/4 x 2	LT250-1/4X2A	90	A
	1/4 x 3	LT250-1/4X3A	90	A
300 MCM	1/4 x 1	LT300-1/4X1A	90	A
	1/4 x 1-1/2	LT300-1/4X1.5A	90	A
	1/4 x 2	LT300-1/4X2A	90	A
	1/4 x 3	LT300-1/4X3A	90	A
350 MCM	1/4 x 1	LT350-1/4X1A	115	A
	1/4 x 1-1/2	LT350-1/4X1.5A	115	A
	1/4 x 2	LT350-1/4X2A	115	A
	1/4 x 3	LT350-1/4X3A	115	A
500 MCM	1/4 x 1-1/2	LT500-1/4X1.5A	200	A
	1/4 x 2	LT500-1/4X2A	200	A
	1/4 x 3	LT500-1/4X3A	200	A
	3/8 x 1-1/2	LT500-3/8X1.5A	200	A
	3/8 x 2	LT500-3/8X2B	2 X 150	B
750 MCM	1/4 x 2	LT750-1/4X2B	2 X 150	B
	1/4 x 3	LT750-1/4X3B	2 X 150	B
	3/8 x 1-1/2	LT750-3/8X1.5B	2 X 150	B
	3/8 x 2	LT750-3/8X2B	2 X 150	B
	3/8 x 3	LT750-3/8X3B	2 X 150	B
1000 MCM	1/4 x 3	LT1000-1/4X3B	2 X 200	B
	3/8 x 2	LT1000-3/8X2B	2 X 200	B
	3/8 x 3	LT1000-3/8X3B	2 X 200	B
	1/2 x 2	LT1000-1/2X2B	2 X 250	B
	1/2 x 3	LT1000-1/2X3B	2 X 250	B

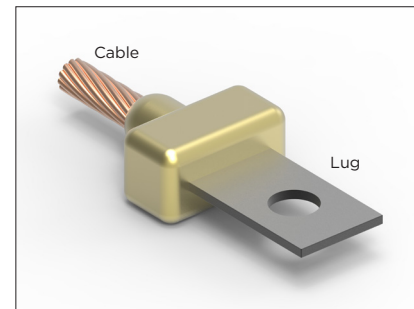

LT

Contact TE Connectivity for molds with other conductor sizes and configurations. TE's AMP Weld exothermically welded connections meets the requirements of IEEE std. 837-2014.

LBT

CABLE TO LUG/BUSBAR CONNECTIONS

- LBT makes straight termination with an upturned lug

GENERAL INFORMATION

- Molds shown are for concentric strand AWG conductors.
- Bare Class A, B, and C based on ASTM Standard Specifications
- Solid conductors are designated with a "S" suffix after the conductor
- Mold Price Key is the last letter in the Mold Catalog Number. i.e. A or B.
- For wear plates add the letter W to the end of the Mold Catalog Number

REQUIRED TOOLS

- ♦ Handle Clamps
- HCLAMP-3 (A Price Key Molds)
- ♦ Flint Ignitor -FLINT IGNITOR

SUGGESTED TOOLS

- Cable Cleaning Brush -CC-BRUSH
- Slag Removal Spade - SLAG-SPADE
- Mold Cleaning Brush - MC-BRUSH
- Torch Head - EXO-TORCH

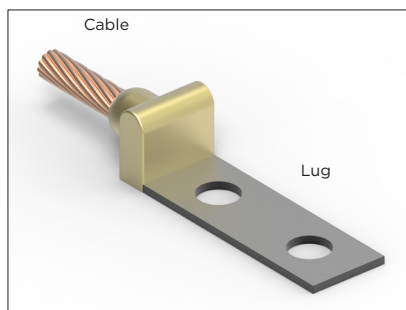

LBT

Cable Size	Bus/Lug Size (in)	Mold Catalog Number	Weld Metal	Mold Price Key
#6	1/8 x 1	LBT6-1/8X1A	32	A
#4	1/8 x 1	LBT4-1/8X1A	32	A
#2 sol	1/8 x 1	LBT2S-1/8X1A	32	A
#2	1/8 x 1	LBT2-1/8X1A	45	A
1/0	1/8 x 1	LBT1/0-1/8X1A	45	A
2/0	1/8 x 1	LBT2/0-1/8X1A	45	A
	3/16 X 1	LBT2/0-3/16X1A	65	A
3/0	1/8 x 1	LBT3/0-1/8X1A	65	A
	3/16 X 1	LBT3/0-3/16X1A	65	A
4/0	1/8 x 1	LBT4/0-1/8X1A	65	A
	3/16 X 1	LBT4/0-3/16X1A	65	A
250 MCM	3/16 X 1	LBT250-3/16X1A	65	A
300 MCM	1/4 X 1	LBT300-1/4X1A	90	A
350 MCM	1/4 X 1	LBT350-1/4X1A	90	A
500 MCM	1/4 X 1-1/2	LBT500-1/4X1.5A	150	A

Contact TE Connectivity for molds with other conductor sizes and configurations.

TE's AMP Weld exothermically welded connections meets the requirements of IEEE std. 837-2014.

BBS

BUSBAR TO BUSBAR CONNECTIONS

- BBS makes a straight busbar splice connection, busbar on edge

GENERAL INFORMATION

- Mold Price Key is the last letter in the Mold Catalog Number. i.e. A or B.
- For wear plates add the letter W to the end of the Mold Catalog Number

REQUIRED TOOLS

- ♦ Handle Clamps
 - HCLAMP-3 (A Price Key Molds)
 - HCLAMP-4 (B Price Key Molds)
- ♦ Flint Ignitor -FLINT IGNITOR

SUGGESTED TOOLS

- Cable Cleaning Brush -CC-BRUSH
- Slag Removal Spade - SLAG-SPADE
- Mold Cleaning Brush - MC-BRUSH
- Torch Head - EXO-TORCH

Bus Size (in)	Mold Catalog Number	Weld Metal	Mold Price Key
1/8 x 1	BBS1/8X1-A	45	A
1/8 x 2	BBS1/8X2-A	90	A
1/8 x 3	BBS1/8X3-A	200	A
1/8 x 4	BBS1/8X4-B	250	B
3/16 x 1	BBS3/16X1-A	65	A
3/16 x 2	BBS3/16X2-A	115	A
1/4 X 1	BBS1/4X1-A	90	A
1/4 X 1-1/4	BBS1/4X1.25-A	115	A
1/4 X 1-1/2	BBS1/4X1.5-A	150	A
1/4 X 2	BBS1/4X2-A	200	A
1/4 X 2-1/2	BBS1/4X2.5-A	250	A
1/4 X 3	BBS1/4X3-A	2 X 200	B
1/4 X 4	BBS1/4X4-A	2 X 250	B
3/8 X 1	BBS3/8X1-A	150	A
3/8 X 1-1/2	BBS3/8X1.5-A	250	A
3/8 X 2	BBS3/8X2-B	2 X 150	B
3/8 X 3	BBS3/8X3-B	2 X 250	B
3/8 X 4	BBS3/8X4-B	3 X 200	B
1/2 X 1	BBS1/2X1-A	200	A
1/2 X 2	BBS1/2X2-A	2 X 200	B

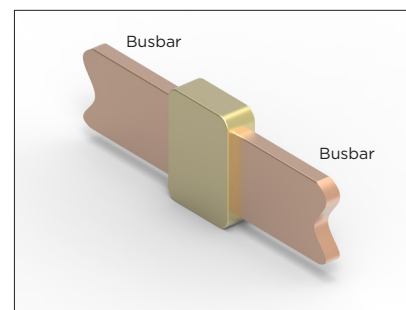

BBS

Contact TE Connectivity for molds with other conductor sizes and configurations.

TE's AMP Weld exothermically welded connections meets the requirements of IEEE std. 837-2014.

BBA

BUSBAR TO BUSBAR CONNECTIONS

- BBA makes a 90° busbar connection, horizontal run and vertical tap. Busbar face in vertical plane

GENERAL INFORMATION

- Mold Price Key is the last letter in the Mold Catalog Number. i.e. A or B.
- For wear plates add the letter W to the end of the Mold Catalog Number

REQUIRED TOOLS

- ♦ Handle Clamps
 - HCLAMP-3 (A Price Key Molds)
 - HCLAMP-4 (B Price Key Molds)
- ♦ Flint Ignitor -FLINT IGNITOR

SUGGESTED TOOLS

- Cable Cleaning Brush -CC-BRUSH
- Slag Removal Spade - SLAG-SPADE
- Mold Cleaning Brush - MC-BRUSH
- Torch Head - EXO-TORCH

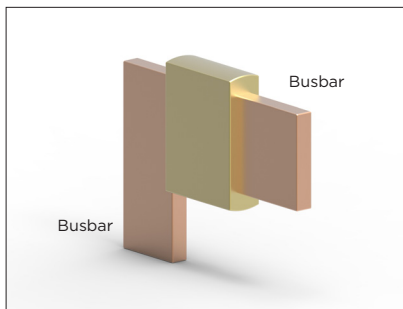

BBA

Bus Size (in)	Mold Catalog Number	Weld Metal	Mold Price Key
1/8 x 1	BBA1/8X1-A	45	A
1/8 x 2	BBA1/8X2-A	90	A
1/8 x 3	BBA1/8X3-A	200	A
1/8 x 4	BBA1/8X4-B	250	B
3/16 x 1	BBA3/16X1-A	65	A
3/16 x 2	BBA3/16X2-A	115	A
1/4 X 1	BBA1/4X1-A	90	A
1/4 X 1-1/4	BBA1/4X1.25-A	115	A
1/4 X 1-1/2	BBA1/4X1.5-A	150	A
1/4 X 2	BBA1/4X2-A	200	A
1/4 X 2-1/2	BBA1/4X2.5-A	250	A
1/4 X 3	BBA1/4X3-B	2 X 200	B
1/4 X 4	BBA1/4X4-B	2 X 250	B
3/8 X 1	BBA3/8X1-A	150	A
3/8 X 1-1/2	BBA3/8X1.5-A	250	A
3/8 X 2	BBA3/8X2-B	2 X 150	B
3/8 X 3	BBA3/8X3-B	2 X 250	B
3/8 X 4	BBA3/8X4-B	3 X 200	B
1/2 X 1	BBA1/2X1-A	200	A
1/2 X 2	BBA1/2X2-B	2 X 200	B

Contact TE Connectivity for molds with other conductor sizes and configurations.

TE's AMP Weld exothermically welded connections meets the requirements of IEEE std. 837-2014.

HE

CABLE TO HORIZONTAL STEEL SURFACE

- HE makes a connection to steel with the conductor off the surface

GENERAL INFORMATION

- Molds shown are for concentric strand AWG conductors.
- Bare Class A, B, and C based on ASTM Standard Specifications
- Solid conductors are designated with a "S" suffix after the conductor
- Mold Price Key is the last letter in the Mold Catalog Number. i.e. A or B.
- For wear plates add the letter W to the end of the Mold Catalog Number

REQUIRED TOOLS

- Handle Clamps
 - HCLAMP-3 (A Price Key Molds)
 - HCLAMP-4 (B Price Key Molds)
- Flint Ignitor -FLINT IGNITOR

SUGGESTED TOOLS

- Cable Cleaning Brush -CC-BRUSH
- Slag Removal Spade - SLAG-SPADE
- Mold Cleaning Brush - MC-BRUSH
- Torch Head - EXO-TORCH

Cable Size	Mold Catalog Number	Weld Metal	Mold Price Key
#6 sol	HE6S-A	65	A
#6	HE6-A	65	A
#4	HE4-A	65	A
#2 sol	HE2S-A	65	A
#2	HE2-A	65	A
1/0	HE1/0-A	90	A
2/0	HE2/0-A	90	A
3/0	HE3/0-A	115	A
4/0	HE4/0-A	115	A
250 MCM	HE250-A	115	A
300 MCM	HE300-A	150	A
350 MCM	HE350-A	200	A
500 MCM	HE500-A	200	A
750 MCM	HE750-B	2 X 150	B
1000 MCM	HE1000-B	2 X 200	B

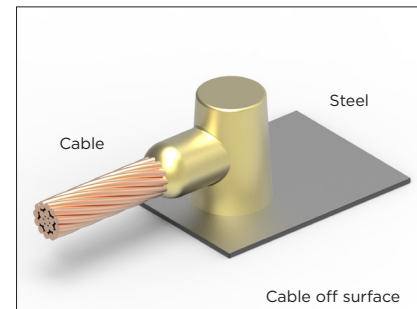

HE

Contact TE Connectivity for molds with other conductor sizes and configurations.

TE's AMP Weld exothermically welded connections meets the requirements of IEEE std. 837-2014.

HE

CABLE TO HORIZONTAL STEEL PIPE

- HE makes a connection to steel pipe with the conductor off the surface

GENERAL INFORMATION:

- Molds shown are for concentric strand AWG conductors.
- Bare Class A, B, and C based on ASTM Standard Specifications
- Solid conductors are designated with a "S" suffix after the conductor
- Mold Price Key is the last letter in the Mold Catalog Number. i.e. A or B.
- For wear plates add the letter W to the end of the Mold Catalog Number

REQUIRED TOOLS

- Handle Clamps
 - HCLAMP-3 (A Price Key Molds)
 - HCLAMP-4 (B Price Key Molds)
- Flint Ignitor -FLINT IGNITOR

SUGGESTED TOOLS

- Cable Cleaning Brush -CC-BRUSH
- Slag Removal Spade - SLAG-SPADE
- Mold Cleaning Brush - MC-BRUSH
- Torch Head - EXO-TORCH
- Chain Clamp
 - CHCLAMP-3H (A Price Key Molds)
 - CHCLAMP-4H (B Price Key Molds)

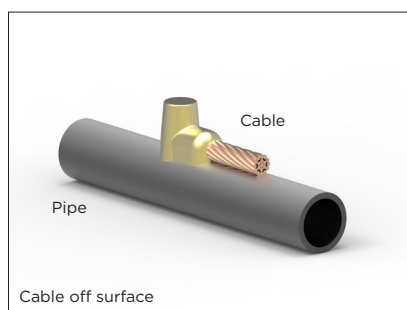

HE

Cable Size	Mold Catalog Number	Weld Metal	Mold Price Key
#6 sol	HE6S-PSA	65	A
#6	HE6-PSA	65	A
#4	HE4-PSA	65	A
#2 sol	HE2S-PSA	65	A
#2	HE2-PSA	65	A
1/0	HE1/0-PSA	90	A
2/0	HE2/0-PSA	90	A
3/0	HE3/0-PSA	115	A
4/0	HE4/0-PSA	115	A
250 MCM	HE250-PSA	115	A
300 MCM	HE300-PSA	150	A
350 MCM	HE350-PSA	200	A
500 MCM	HE500-PSA	200	A
750 MCM	HE750-PSB	2 X 150	B
1000 MCM	HE1000-PSB	2 X 200	B

PS - add pipe size to mold part number here

Cable to Steel Pipe (Types HE)

Use flat surface mold part number with Pipe Size Indicator PS

Cable	Nominal Pipe Size	Pipe Size Indicator
#1 and Smaller	12 inches and Smaller	Nominal Pipe Size
	14 inches and Larger	None
1/0 thru 250 MCM	28 inches and Smaller	Nominal Pipe Size
	30 inches and Larger	None

Example: 4/0 conductor to 6" Pipe (Off Surface) - HE4/0-6A
 #2 Conductor to 4"Pipe (Off Surface) - HE2-4A

Contact TE Connectivity for molds with other conductor sizes and configurations.

TE's AMP Weld exothermically welded connections meets the requirements of IEEE std. 837-2014.

HOE

CABLE TO HORIZONTAL STEEL SURFACE

- HOE makes a connection to steel with the conductor on the surface

GENERAL INFORMATION:

- Molds shown are for concentric strand AWG conductors.
- Bare Class A, B, and C based on ASTM Standard Specifications
- Solid conductors are designated with a "S" suffix after the conductor
- Mold Price Key is the last letter in the Mold Catalog Number. i.e. A or B.
- For wear plates add the letter W to the end of the Mold Catalog Number

REQUIRED TOOLS

- Handle Clamps
 - HCLAMP-3 (A Price Key Molds)
 - HCLAMP-4 (B Price Key Molds)
- Flint Ignitor -FLINT IGNITOR
- Mold Sealer - MOLD-SEALER

SUGGESTED TOOLS

- Cable Cleaning Brush -CC-BRUSH
- Slag Removal Spade - SLAG-SPADE
- Mold Cleaning Brush - MC-BRUSH
- Torch Head - EXO-TORCH

Cable Size	Mold Catalog Number	Weld Metal	Mold Price Key
#6 sol	HOE6S-A	45	A
#6	HOE6-A	45	A
#4	HOE4-A	45	A
#2 sol	HOE2S-A	45	A
#2	HOE2-A	45	A
1/0	HOE1/0-A	90	A
2/0	HOE2/0-A	90	A
3/0	HOE3/0-A	115	A
4/0	HOE4/0-A	115	A
250 MCM	HOE250-A	115	A
300 MCM	HOE300-A	150	A
350 MCM	HOE350-A	200	A
500 MCM	HOE500-A	200	A
750 MCM	HOE750-B	2 X 150	B
1000 MCM	HOE1000-B	2 X 200	B

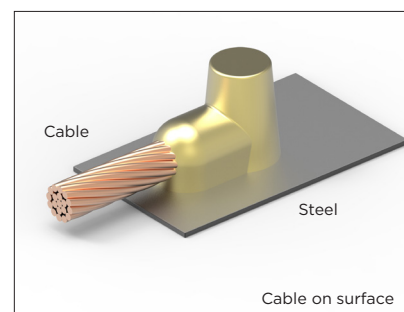

HOE

Contact TE Connectivity for molds with other conductor sizes and configurations.

TE's AMP Weld exothermically welded connections meets the requirements of IEEE std. 837-2014.

HOE

CABLE TO HORIZONTAL STEEL PIPE

- HOE makes a connection to horizontal steel pipe with the conductor on the surface

GENERAL INFORMATION:

- Molds shown are for concentric strand AWG conductors.
- Bare Class A, B, and C based on ASTM Standard Specifications
- Solid conductors are designated with a "S" suffix after the conductor
- Mold Price Key is the last letter in the Mold Catalog Number. i.e. A or B.
- For wear plates add the letter W to the end of the Mold Catalog Number

REQUIRED TOOLS

- Handle Clamps
- HCLAMP-3 (A Price Key Molds)
- Flint Ignitor -FLINT IGNITOR
- Mold Sealer - MOLD-SEALER

SUGGESTED TOOLS

- Cable Cleaning Brush -CC-BRUSH
- Slag Removal Spade - SLAG-SPADE
- Mold Cleaning Brush - MC-BRUSH
- Torch Head - EXO-TORCH
- Chain Clamp - CHCLAMP-3H (A Price Key Molds)

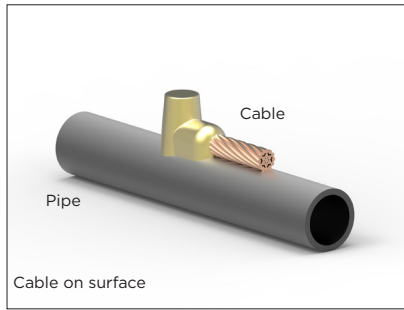

HOE

Cable Size	Mold Catalog Number	Weld Metal	Mold Price Key
#6 sol	HOE6S-PSA	45	A
#6	HOE6-PSA	45	A
#4	HOE4-PSA	45	A
#2 sol	HOE2S-PSA	45	A
#2	HOE2-PSA	45	A
1/0	HOE1/0-PSA	90	A
2/0	HOE2/0-PSA	90	A
3/0	HOE3/0-PSA	115	A
4/0	HOE4/0-PSA	115	A
250 MCM	HOE250-PSA	115	A

PS - add pipe size to mold part number here

Cable to Steel Pipe (Types HOE)

Use flat surface mold part number with Pipe Size Indicator PS

Cable	Nominal Pipe Size	Pipe Size Indicator
#1 and Smaller	12 inches and Smaller	Nominal Pipe Size
	14 inches and Larger	None
1/0 thru 250 MCM	28 inches and Smaller	Nominal Pipe Size
	30 inches and Larger	None

Example: 4/0 conductor to 6" Pipe (On Surface) - HOE4/0-6A
#2 Conductor to 4" Pipe (On Surface) - HOE2-4A

Contact TE Connectivity for molds with other conductor sizes and configurations.

TE's AMP Weld exothermically welded connections meets the requirements of IEEE std. 837-2014.

CABLE TO HORIZONTAL STEEL SURFACE

- HR makes a through connection to steel with the conductor off the surface

GENERAL INFORMATION

- Molds shown are for concentric strand AWG conductors.
- Bare Class A, B, and C based on ASTM Standard Specifications
- Solid conductors are designated with a "S" suffix after the conductor
- Mold Price Key is the last letter in the Mold Catalog Number. i.e. A or B.
- For wear plates add the letter W to the end of the Mold Catalog Number

REQUIRED TOOLS

- ♦ Handle Clamps - HCLAMP-3 (A Price Key Molds)
- ♦ Flint Ignitor -FLINT IGNITOR

SUGGESTED TOOLS

- Cable Cleaning Brush -CC-BRUSH
- Slag Removal Spade - SLAG-SPADE
- Mold Cleaning Brush - MC-BRUSH
- Torch Head - EXO-TORCH

Cable Size	Mold Catalog Number	Weld Metal	Mold Price Key
#2 sol	HR2S-A	65	A
#2	HR2-A	65	A
1/0	HR1/0-A	90	A
2/0	HR2/0-A	115	A
3/0	HR3/0-A	115	A
4/0	HR4/0-A	150	A
250 MCM	HR250-A	150	A
300 MCM	HRE300-A	200	A
350 MCM	HR350-A	250	A
500 MCM	HR500-B	2 X 150	A

Contact TE Connectivity for molds with other conductor sizes and configurations.

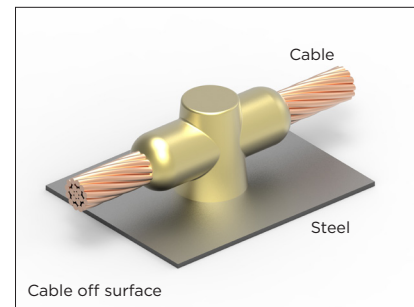

HR

CABLE TO HORIZONTAL STEEL SPIPE

- HR makes a through connection to steel pipe with the conductor off the surface

GENERAL INFORMATION

- Molds shown are for concentric strand AWG conductors.
- Bare Class A, B, and C based on ASTM Standard Specifications
- Solid conductors are designated with a "S" suffix after the conductor
- Mold Price Key is the last letter in the Mold Catalog Number. i.e. A or B.
- For wear plates add the letter W to the end of the Mold Catalog Number

REQUIRED TOOLS

- Handle Clamps
- HCLAMP-3 (A Price Key Molds)
- Flint Ignitor -FLINT IGNITOR

SUGGESTED TOOLS

- Cable Cleaning Brush -CC-BRUSH
- Slag Removal Spade - SLAG-SPADE
- Mold Cleaning Brush - MC-BRUSH
- Torch Head - EXO-TORCH
- Chain Clamp - CHCLAMP-3H (A Price Key Molds)

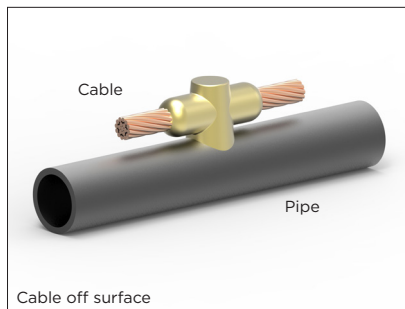

HR

Cable Size	Mold Catalog Number	Weld Metal	Mold Price Key
#2 sol	HR2S- PSA	65	A
#2	HR2- PSA	65	A
1/0	HR1/0- PSA	90	A
2/0	HR2/0- PSA	115	A
3/0	HR3/0- PSA	115	A
4/0	HR4/0- PSA	150	A
250 MCM	HR250- PSA	150	A
300 MCM	HRE300- PSA	200	A
350 MCM	HR350- PSA	250	A
500 MCM	HR500- PSB	2 X 150	A

PS - add pipe size to mold part number here

Cable to Steel Pipe (Types of HR)		
Use flat surface mold part number with Pipe Size Indicator PS		
Cable	Nominal Pipe Size	Pipe Size Indicator
#1 and Smaller	12 inches and Smaller	Nominal Pipe Size
	14 inches and Larger	None
1/0 thru 250 MCM	28 inches and Smaller	Nominal Pipe Size
	30 inches and Larger	None
Example: 4/0 conductor to 6" Pipe (Off Surface) - HR4/0- 6A #2 Conductor to 4" Pipe (Off Surface) - HR2- 4A		

Contact TE Connectivity for molds with other conductor sizes and configurations.

TE's AMP Weld exothermically welded connections meets the requirements of IEEE std. 837-2014.

HOR

CABLE TO HORIZONTAL STEEL SURFACE

- HOR makes a through connection to steel with the conductor on the surface

GENERAL INFORMATION

- Molds shown are for concentric strand AWG conductors.
- Bare Class A, B, and C based on ASTM Standard Specifications
- Solid conductors are designated with a "S" suffix after the conductor
- Mold Price Key is the last letter in the Mold Catalog Number. i.e. A or B.
- For wear plates add the letter W to the end of the Mold Catalog Number

REQUIRED TOOLS

- ♦ Handle Clamps
 - HCLAMP-3 (A Price Key Molds)
 - HCLAMP-4 (B Price Key Molds)
- ♦ Flint Ignitor -FLINT IGNITOR
- ♦ Mold Sealer - MOLD-SEALER

SUGGESTED TOOLS

- Cable Cleaning Brush -CC-BRUSH
- Slag Removal Spade - SLAG-SPADE
- Mold Cleaning Brush - MC-BRUSH
- Torch Head - EXO-TORCH

Cable Size	Mold Catalog Number	Weld Metal	Mold Price Key
#6 sol	HOR6S-A	45	A
#6	HOR6-A	45	A
#4	HOR4-A	45	A
#2 sol	HOR2S-A	45	A
#2	HOR2-A	45	A
1/0	HOR1/0-A	90	A
2/0	HOR2/0-A	115	A
3/0	HOR3/0-A	115	A
4/0	HOR4/0-A	150	A
250 MCM	HOR250-A	150	A
300 MCM	HOR300-A	200	A
350 MCM	HOR350-A	200	A
500 MCM	HOR500-B	2 X 150	B

Contact TE Connectivity for molds with other conductor sizes and configurations.

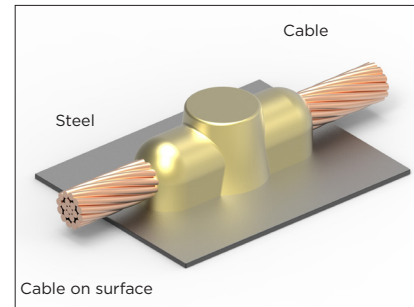

HOR

HOR

CABLE TO HORIZONTAL STEEL PIPE

- HOR makes a through connection to steel pipe with the conductor on the surface

GENERAL INFORMATION

- Molds shown are for concentric strand AWG conductors.
- Bare Class A, B, and C based on ASTM Standard Specifications
- Solid conductors are designated with a "S" suffix after the conductor
- Mold Price Key is the last letter in the Mold Catalog Number. i.e. A or B.
- For wear plates add the letter W to the end of the Mold Catalog Number

REQUIRED TOOLS

- Handle Clamps
- HCLAMP-3 (A Price Key Molds)
- Flint Ignitor -FLINT IGNITOR
- Mold Sealer - MOLD-SEALER

SUGGESTED TOOLS

- Cable Cleaning Brush -CC-BRUSH
- Slag Removal Spade - SLAG-SPADE
- Mold Cleaning Brush - MC-BRUSH
- Torch Head - EXO-TORCH
- Chain Clamp
- CHCLAMP-3H (A Price Key Molds)

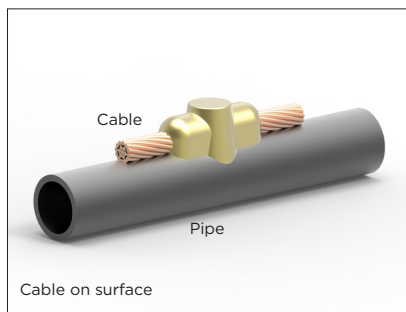

HOR

Cable Size	Mold Catalog Number	Weld Metal	Mold Price Key
#6 sol	HOR6S-PSA	45	A
#6	HOR6-PSA	45	A
#4	HOR4-PSA	45	A
#2 sol	HOR2S-PSA	45	A
#2	HOR2-PSA	45	A
1/0	HOR1/0-PSA	90	A
2/0	HOR2/0-PSA	115	A
3/0	HOR3/0-PSA	115	A
4/0	HOR4/0-PSA	150	A
250 MCM	HOR250-PSA	150	A

PS - add pipe size to mold part number here

Cable to Steel Pipe (Types HOR)

Use flat surface mold part number with Pipe Size Indicator PS

Cable	Nominal Pipe Size	Pipe Size Indicator
#1 and Smaller	12 inches and Smaller	Nominal Pipe Size
	14 inches and Larger	None
1/0 thru 250 MCM	28 inches and Smaller	Nominal Pipe Size
	30 inches and Larger	None
Example: 4/0 conductor to 6" Pipe (On Surface) - HOR4/0-6A		
#2 Conductor to 4" Pipe (On Surface) - HOR2-4A		

Contact TE Connectivity for molds with other conductor sizes and configurations.

TE's AMP Weld exothermically welded connections meets the requirements of IEEE std. 837-2014.

**CABLE TO VERTICAL STEEL SURFACE/
PIPE**

- VAD makes a connection to steel with the conductor down at a 45° angle to vertical steel

GENERAL INFORMATION

- Molds shown are for concentric strand AWG conductors.
- Bare Class A, B, and C based on ASTM Standard Specifications
- Solid conductors are designated with a "S" suffix after the conductor
- Mold Price Key is the last letter in the Mold Catalog Number. i.e. A or B.
- For wear plates add the letter W to the end of the Mold Catalog Number

REQUIRED TOOLS

- Handle Clamps
 - HCLAMP-3 (A Price Key Molds)
 - HCLAMP-4 (B Price Key Molds)
- Flint Ignitor -FLINT IGNITOR

SUGGESTED TOOLS

- Cable Cleaning Brush -CC-BRUSH
- Slag Removal Spade - SLAG-SPADE
- Mold Cleaning Brush - MC-BRUSH
- Torch Head - EXO-TORCH
- Chain Clamp
 - CHCLAMP-3V (A Price Key Molds)
 - CHCLAMP-4V (B Price Key Molds)
- Magnetic Clamp
 - MHCLAMP-3 (A Price Key Molds)
 - MHCLAMP-4 (B Price Key Molds)
- C-Clamp
 - CCLAMP-3 (A Price Key Molds)
 - CCLAMP-4 (B Price Key Molds)

Cable Size	Flat Surface Mold Catalog Number	Vertical Pipe Mold Catalog Number	Weld Metal	Mold Price Key
#6 sol	VAD6S-A	VAD6S-V PSA	45	A
#6	VAD6-A	VAD6-V PSA	45	A
#4	VAD4-A	VAD4-V PSA	45	A
#2 sol	VAD2S-A	VAD2S-V PSA	45	A
#2	VAD2-A	VAD2-V PSA	45	A
1/0	VAD1/0-A	VAD1/0-V PSA	90	A
2/0	VAD2/0-A	VAD2/0-V PSA	90	A
3/0	VAD3/0-A	VAD3/0-V PSA	115	A
4/0	VAD4/0-A	VAD4/0-V PSA	115	A
250 MCM	VAD250-A	VAD250-V PSA	115	A
300 MCM	VAD300-A	VAD300-V PSA	150	A
350 MCM	VAD350-A	VAD350-V PSA	200	A
500 MCM	VAD500-A	VAD500-V PSA	200	A
750 MCM	VAD750-B	VAD750-V PSB	2 X 150	B
1000 MCM	VAD1000-B	VAD1000-V PSB	2 X 200	B

PS - add pipe size to mold part number here

Cable to Steel Pipe (Types VAD)		
Use flat surface mold part number with Pipe Size Indicator PS		
Cable	Nominal Pipe Size	Pipe Size Indicator
#6 thru 250 MCM	30 inches and Smaller	None
	32 inches and Larger	None
Example: 2/0 conductor to 8" Pipe - VAD2/0-V 8A		
4/0 conductor to 32" Pipe - VAD4/0-A		

Contact TE Connectivity for molds with other conductor sizes and configurations.

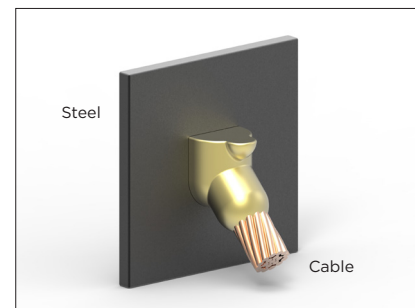

VAD

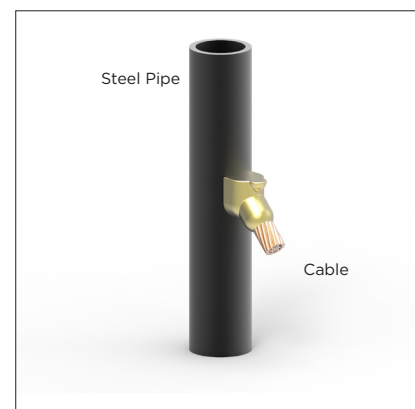

VAD

TE's AMP Weld exothermically welded connections meets the requirements of IEEE std. 837-2014.

VAD

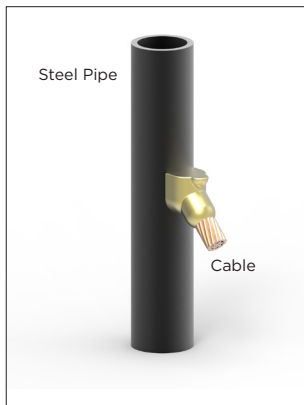

VAD

VAD FOR PIPE (RANGE TAKING MOLDS)

Cable Size	Nominal Pipe Range (in)	Vertical Pipe Mold Catalog Number	Weld Metal	Mold Price Key
#6 sol	1 1/2 to 4	VAD6S-V1.5X4A	45	A
	4 to 6	VAD6S-V4X6A	45	A
	6 to 10	VAD6S-V6X10A	45	A
	12 to 30	VAD6S-V12X30A	45	A
	32 and Larger	VAD6S-A	45	A
#6	1 1/2 to 4	VAD6-V1.5X4A	45	A
	4 to 6	VAD6-V4X6A	45	A
	6 to 10	VAD6-V6X10A	45	A
	12 to 30	VAD6-V12X30A	45	A
	32 and Larger	VAD6-A	45	A
#4	1 1/2 to 4	VAD4-V1.5X4A	45	A
	4 to 6	VAD4-V4X6A	45	A
	6 to 10	VAD4-V6X10A	45	A
	12 to 30	VAD4-V12X30A	45	A
	32 and Larger	VAD4-A	45	A
#2 Sol	1 1/2 to 4	VAD2S-V1.5X4A	45	A
	4 to 6	VAD2S-V4X6A	45	A
	6 to 10	VAD2S-V6X10A	45	A
	12 to 30	VAD2S-V12X30A	45	A
	32 and Larger	VAD2S-A	45	A
#2	1 1/2 to 4	VAD2-V1.5X4A	45	A
	4 to 6	VAD2-V4X6A	45	A
	6 to 10	VAD2-V6X10A	45	A
	12 to 30	VAD2-V12X30A	45	A
	32 and Larger	VAD2-A	45	A
1/0	1 1/2 to 4	VAD1/0-V1.5X4A	90	A
	4 to 6	VAD1/0-V4X6A	90	A
	6 to 10	VAD1/0-V6X10A	90	A
	12 to 30	VAD1/0-V12X30A	90	A
	32 and Larger	VAD1/0-A	90	A
2/0	1 1/2 to 4	VAD2/0-V1.5X4A	90	A
	4 to 6	VAD2/0-V4X6A	90	A
	6 to 10	VAD2/0-V6X10A	90	A
	12 to 30	VAD2/0-V12X30A	90	A
	32 and Larger	VAD2/0-A	90	A
3/0	1 1/2 to 4	VAD3/0-V1.5X4A	115	A
	4 to 6	VAD3/0-V4X6A	115	A
	6 to 10	VAD3/0-V6X10A	115	A
	12 to 30	VAD3/0-V12X30A	115	A
	32 and Larger	VAD3/0-A	115	A
4/0	1 1/2 to 4	VAD4/0-V1.5X4A	115	A
	4 to 6	VAD4/0-V4X6A	115	A
	6 to 10	VAD4/0-V6X10A	115	A
	12 to 30	VAD4/0-V12X30A	115	A
	32 and Larger	VAD4/0-A	115	A

Contact TE Connectivity for molds with other conductor sizes and configurations.

TE's AMP Weld exothermically welded connections meets the requirements of IEEE std. 837-2014.

VSD

Exothermically
Welded
Grounding
Connections**CABLE TO VERTICAL STEEL SURFACE/
PIPE**

- VSD makes a connection to steel with the conductor straight down off vertical steel

GENERAL INFORMATION

- Molds shown are for concentric strand AWG conductors.
- Bare Class A, B, and C based on ASTM Standard Specifications
- Solid conductors are designated with a "S" suffix after the conductor
- Mold Price Key is the last letter in the Mold Catalog Number. i.e. A or B.
- For wear plates add the letter W to the end of the Mold Catalog Number

REQUIRED TOOLS

- Handle Clamps
- HCLAMP-3 (A Price Key Molds)
- Flint Ignitor -FLINT IGNITOR

SUGGESTED TOOLS

- Cable Cleaning Brush -CC-BRUSH
- Slag Removal Spade - SLAG-SPADE
- Mold Cleaning Brush - MC-BRUSH
- Torch Head - EXO-TORCH
- Chain Clamp
- CHCLAMP-3V (A Price Key Molds)
- Magnetic Clamp
- MHCLAMP-3 (A Price Key Molds)
- C-Clamp
- CCLAMP-3 (A Price Key Molds)

Cable Size	Flat Surface Mold Catalog Number	Vertical Pipe Mold Catalog Number	Weld Metal	Mold Price Key
#6 sol	VSD6S-A	VSD6S-VPSA	45	A
#6	VSD6-A	VSD6-VPSA	45	A
#4	VSD4-A	VSD4-VPSA	65	A
#2 sol	VSD2S-A	VSD2S-VPSA	65	A
#2	VSD2-A	VSD2-VPSA	65	A
1/0	VSD1/0-A	VSD1/0-VPSA	115	A
2/0	VSD2/0-A	VSD2/0-VPSA	115	A
3/0	VSD3/0-A	VSD3/0-VPSA	150	A
4/0	VSD4/0-A	VSD4/0-VPSA	150	A
250 MCM	VSD250-A	VSD250-VPSA	200	A
300 MCM	VSD300-A	VSD300-VPSA	200	A
350 MCM	VSD350-A	VSD350-VPSA	250	A
500 MCM	VSD500-A	VSD500-VPSA	2 X 150	A

PS - add pipe size to mold part number here

Cable to Steel Pipe (Types VSD)		
Use flat surface mold part number with Pipe Size Indicator PS		
Cable	Nominal Pipe Size	Pipe Size Indicator
#1 and Smaller	12 inches and Smaller	Nominal Pipe Size
	14 inches and Larger	None
1/0 thru 250 MCM	28 inches and Smaller	Nominal Pipe Size
	30 inches and Larger	None

Example: 4/0 conductor to 6" Pipe (Off Surface) - VSD4/0-V6A
#2 Conductor to 4" Pipe (On Surface) - VSD2-V4A

VSD FOR PIPE (RANGE TAKING MOLDS)

Cable Size	Nominal Pipe Range (in)	Vertical Surface Pipe Mold Catalog No.	Weld Metal	Mold Price Key
#2 sol	1 1/2 to 4	VSD2S-V1.5X4A	65	A
#2	1 1/2 to 4	VSD2-V1.5X4A	65	A
1/0	1 1/2 to 4	VSD1/0-V1.5X3.5A	115	A
2/0	1 1/2 to 3 1/2	VSD2/0-V1.5X3.5A	115	A
	2 to 4	VSD2/0-V2X4A	115	A
4/0	1 1/2 to 3 1/2	VSD4/0-V1.5X3.5A	150	A
	2 to 4	VSD4/0-V2X4A	150	A

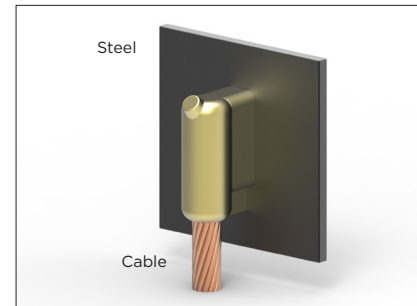

VSD

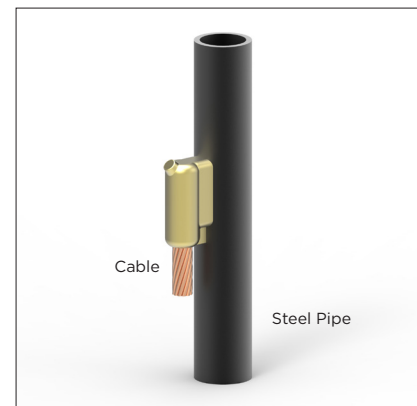

VSD

Contact TE Connectivity for molds with other conductor sizes and configurations. TE's AMP Weld exothermically welded connections meets the requirements of IEEE std. 837-2014.

VSU

CABLE TO VERTICAL STEEL SURFACE/ PIPE

- VSU makes a connection to steel with a vertical conductor terminating to vertical steel

GENERAL INFORMATION

- Molds shown are for concentric strand AWG conductors.
- Bare Class A, B, and C based on ASTM Standard Specifications
- Solid conductors are designated with a "S" suffix after the conductor
- Mold Price Key is the last letter in the Mold Catalog Number. i.e. A or B.
- For wear plates add the letter W to the end of the Mold Catalog Number

REQUIRED TOOLS

- Handle Clamps
 - HCLAMP-3 (A Price Key Molds)
 - HCLAMP-4 (B Price Key Molds)
- Flint Ignitor -FLINT IGNITOR

SUGGESTED TOOLS

- Cable Cleaning Brush -CC-BRUSH
- Slag Removal Spade - SLAG-SPADE
- Mold Cleaning Brush - MC-BRUSH
- Torch Head - EXO-TORCH
- Chain Clamp
 - CHCLAMP-3 (A Price Key Molds)
 - CHCLAMP-4 (B Price Key Molds)
- Magnetic Clamp
 - MHCLAMP-3 (A Price Key Molds)
 - MHCLAMP-4 (B Price Key Molds)
- C-Clamp
 - HCLAMP-3 (A Price Key Molds)
 - HCLAMP-4 (B Price Key Molds)

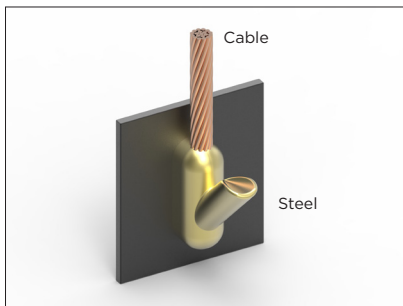

VSU

Cable Size	Flat Surface Mold Catalog Number	Vertical Pipe Mold Catalog Number	Weld Metal	Mold Price Key
#6 sol	VSU6S-A	VSU6S-VPSA	65	A
#6	VSU6-A	VSU6-VPSA	65	A
#4	VSU4-A	VSU4-VPSA	65	A
#2 sol	VSU2S-A	VSU2S-VPSA	65	A
#2	VSU2-A	VSU2-VPSA	65	A
1/0	VSU1/0-A	VSU1/0-VPSA	150	A
2/0	VSU2/0-A	VSU2/0-VPSA	150	A
3/0	VSU3/0-A	VSU3/0-VPSA	200	A
4/0	VSU4/0-A	VSU4/0-VPSA	200	A
250 MCM	VSU250-A	VSU250-VPSA	200	A
300 MCM	VSU300-A	N/A	250	A
350 MCM	VSU350-B	N/A	2 X 150	B
500 MCM	VSU500-B	N/A	2 X 200	B
750 MCM	VSU750-B	N/A	2 X 250	B

PS - add pipe size to mold part number here

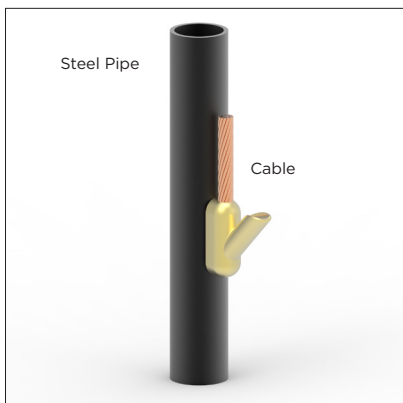

VSU

Cable to Steel Pipe (Types VSU)

Use flat surface mold part number with Pipe Size Indicator PS

Cable	Nominal Pipe Size	Pipe Size Indicator
#6 thru 250 MCM	28 inches and Smaller	Nominal Pipe Size
	30 inches and Larger	None

Example: 1/0 conductor to 12" Pipe - VSU1/0-V12A
4/0 Conductor to 32" Pipe - VSU4/0-A

Contact TE Connectivity for molds with other conductor sizes and configurations.

TE's AMP Weld exothermically welded connections meets the requirements of IEEE std. 837-2014.

**CABLE TO VERTICAL STEEL SURFACE/
PIPE**

- VSV makes a connection to steel with a through vertical conductor to vertical steel

GENERAL INFORMATION

- Molds shown are for concentric strand AWG conductors.
- Bare Class A, B, and C based on ASTM Standard Specifications
- Solid conductors are designated with a "S" suffix after the conductor
- Mold Price Key is the last letter in the Mold Catalog Number. i.e. A or B.
- For wear plates add the letter W to the end of the Mold Catalog Number

REQUIRED TOOLS

- Handle Clamps
- HCLAMP-3 (A Price Key Molds)
- Flint Ignitor -FLINT IGNITOR

SUGGESTED TOOLS

- Cable Cleaning Brush -CC-BRUSH
- Slag Removal Spade - SLAG-SPADE
- Mold Cleaning Brush - MC-BRUSH
- Torch Head - EXO-TORCH
- Chain Clamp
- CHCLAMP-3 (A Price Key Molds)
- Magnetic Clamp
- MHCLAMP-3 (A Price Key Molds)
- C-Clamp
- CCLAMP-3 (A Price Key Molds)

Cable Size	Flat Surface Mold Catalog Number	Vertical Pipe Mold Catalog Number	Weld Metal	Mold Price Key
#6 sol	VSV6S-A	VSV6S-V PSA	90	A
#6	VSV6-A	VSV6-V PSA	90	A
#4	VSV4-A	VSV4-V PSA	90	A
#2 sol	VSV2S-A	VSV2S-V PSA	115	A
#2	VSV2-A	VSV2-V PSA	115	A
1/0	VSV1/0-A	VSV1/0-V PSA	200	A
2/0	VSV2/0-A	VSV2/0-V PSA	200	A
3/0	VSV3/0-A	VSV3/0-V PSA	250	A
4/0	VSV4/0-A	VSV4/0-V PSA	250	A
250 MCM	VSV250-A	VSV250-V PSA	250	A

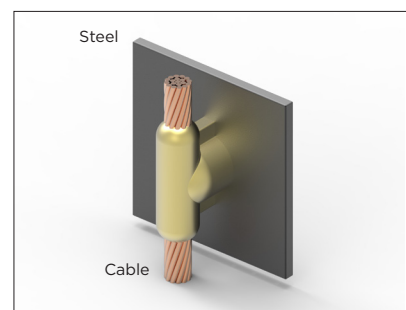
**VSV**

PS - add pipe size to mold part number here

Cable to Steel Pipe (Types VSV)		
Use flat surface mold part number with Pipe Size Indicator PS		
Cable	Nominal Pipe Size	Pipe Size Indicator
#6 thru 250 MCM	28 inches and Smaller	Nominal Pipe Size
	30 inches and Larger	None
Example: 1/0 conductor to 12" Pipe - VSV1/0-V 12A 4/0 Conductor to 32" Pipe - VSV4/0-A		

Contact TE Connectivity for molds with other conductor sizes and configurations.

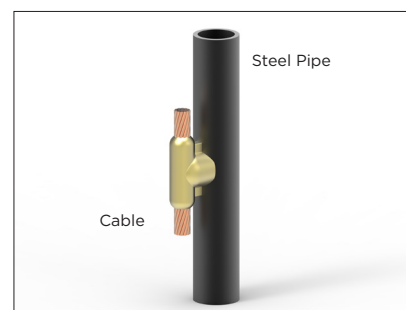
**VSV**

VSH

CABLE TO VERTICAL STEEL SURFACE/ PIPE

- VSH makes a through connection of a horizontal conductor to vertical steel, off surface

GENERAL INFORMATION

- Molds shown are for concentric strand AWG conductors.
- Bare Class A, B, and C based on ASTM Standard Specifications
- Solid conductors are designated with a "S" suffix after the conductor
- Mold Price Key is the last letter in the Mold Catalog Number. i.e. A or B.
- For wear plates add the letter W to the end of the Mold Catalog Number

REQUIRED TOOLS

- Handle Clamps
 - HCLAMP-3 (A Price Key Molds)
- Flint Ignitor -FLINT IGNITOR

SUGGESTED TOOLS

- Cable Cleaning Brush -CC-BRUSH
- Slag Removal Spade - SLAG-SPADE
- Mold Cleaning Brush - MC-BRUSH
- Torch Head - EXO-TORCH
- Chain Clamp
 - CHCLAMP-3 (A Price Key Molds)
- Magnetic Clamp
 - MHCLAMP-3 (A Price Key Molds)
- C-Clamp
 - CCLAMP-3 (A Price Key Molds)

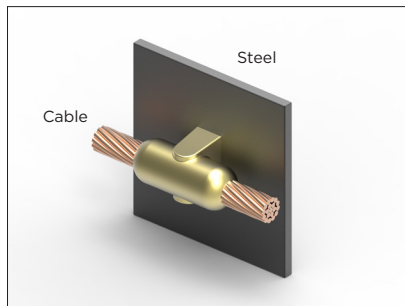

VSH

Cable Size	Flat Surface Mold Catalog Number	Vertical Pipe Mold Catalog Number	Weld Metal	Mold Price Key
#6 sol	VSH6S-A	VSH6S-VPSA	65	A
#6	VSH6-A	VSH6-VPSA	65	A
#4	VSH4-A	VSH4-VPSA	65	A
#2 sol	VSH2S-A	VSH2S-VPSA	65	A
#2	VSH2-A	VSH2-VPSA	65	A
1/0	VSH1/0-A	VSH1/0-VPSA	115	A
2/0	VSH2/0-A	VSH2/0-VPSA	115	A
3/0	VSH3/0-A	VSH3/0-VPSA	150	A
4/0	VSH4/0-A	VSH4/0-VPSA	150	A
250 MCM	VSH250-A	VSH250-VPSA	150	A

PS - add pipe size to mold part number here

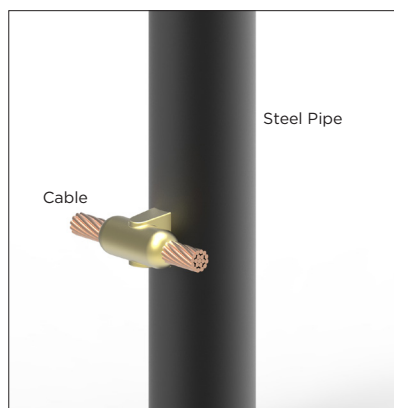

VSH

Cable to Steel Pipe (Types VSH)

Use flat surface mold part number with Pipe Size Indicator PS

Cable	Nominal Pipe Size	Pipe Size Indicator
#1 and Smaller	12 inches and Smaller	Nominal Pipe Size
	14 inches and larger	none
1/0 thru 250 MCM	28 inches and smaller	Nominal Pipe Size
	30 inches and larger	None

Example: 4/0 conductor to 8" Pipe - VSH4/0-V8A
250MCM Conductor to 30" Pipe - VSH250-A

Contact TE Connectivity for molds with other conductor sizes and configurations.

TE's AMP Weld exothermically welded connections meets the requirements of IEEE std. 837-2014.

VSOH

**CABLE TO VERTICAL STEEL SURFACE/
PIPE**

- VSOH makes a through connection of a horizontal conductor to vertical steel, on surface

GENERAL INFORMATION

- Molds shown are for concentric strand AWG conductors.
- Bare Class A, B, and C based on ASTM Standard Specifications
- Solid conductors are designated with a "S" suffix after the conductor
- Mold Price Key is the last letter in the Mold Catalog Number. i.e. A or B.
- For wear plates add the letter W to the end of the Mold Catalog Number

REQUIRED TOOLS

- Handle Clamps
- HCLAMP-3 (A Price Key Molds)
- Flint Ignitor -FLINT IGNITOR
- Mold Sealer - MOLD-SEALER

SUGGESTED TOOLS

- Cable Cleaning Brush -CC-BRUSH
- Slag Removal Spade - SLAG-SPADE
- Mold Cleaning Brush - MC-BRUSH
- Torch Head - EXO-TORCH
- Magnetic Clamp
- MHCLAMP-3 (A Price Key Molds)
- C-Clamp
- HCLAMP-3 (A Price Key Molds)

Cable Size	Flat Surface Mold Catalog Number	Vertical Pipe Mold Catalog Number	Weld Metal	Mold Price Key
#6 sol	VSOH6S-A	VSOH6S-HPSA	45	A
#6	VSOH6-A	VSOH6-HPSA	45	A
#4	VSOH4-A	VSOH4-HPSA	45	A
#2 sol	VSOH2S-A	VSOH2S-HPSA	45	A
#2	VSOH2-A	VSOH2-HPSA	45	A
1/0	VSOH1/0-A	VSOH1/0-HPSA	115	A
2/0	VSOH2/0-A	VSOH2/0-HPSA	115	A
3/0	VSOH3/0-A	VSOH3/0-HPSA	150	A
4/0	VSOH4/0-A	VSOH4/0-HPSA	150	A
250 MCM	VSOH250-A	VSOH250-HPSA	150	A

PS - add pipe size to mold part number here

Cable to Steel Pipe (Types of VSOH) Use flat surface mold part number with Pipe Size Indicator PS		
Cable	Nominal Pipe Size	Pipe Size Indicator
#6 thru 250 MCM	All sizes	Nominal Pipe Size
Example: 1/0 conductor to 12" Pipe - VSOH1/0-H12A		
#2 Conductor to 4" Pipe - VSOH2-H4A		

Contact TE Connectivity for molds with other conductor sizes and configurations.

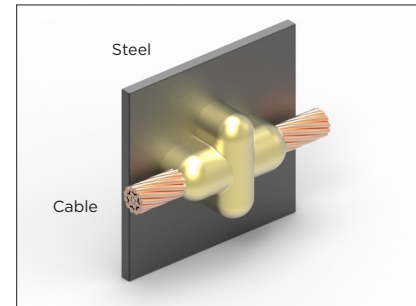

VSOH

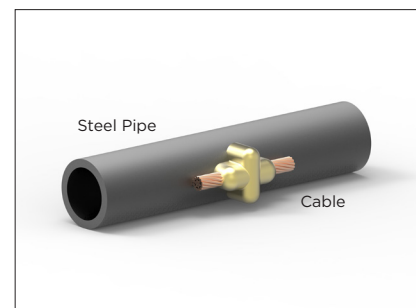

VSOH

VSL

CABLE TO VERTICAL STEEL SURFACE/ PIPE

- VSL makes a connection (off to the left) of a horizontal conductor to vertical flat steel or vertical side of a horizontal pipe.

GENERAL INFORMATION

- Molds shown are for concentric strand AWG conductors.
- Bare Class A, B, and C based on ASTM Standard Specifications
- Solid conductors are designated with a "S" suffix after the conductor
- Mold Price Key is the last letter in the Mold Catalog Number. i.e. A or B.
- For wear plates add the letter W to the end of the Mold Catalog Number

REQUIRED TOOLS

- Handle Clamps
 - HCLAMP-3 (A Price Key Molds)
- Flint Ignitor -FLINT IGNITOR
- Mold Sealer - MOLD-SEALER

SUGGESTED TOOLS

- Cable Cleaning Brush -CC-BRUSH
- Slag Removal Spade - SLAG-SPADE
- Mold Cleaning Brush - MC-BRUSH
- Torch Head - EXO-TORCH
- Magnetic Clamp
 - MHCLAMP-3 (A Price Key Molds)
- C-Clamp
 - CCLAMP-3 (A Price Key Molds)

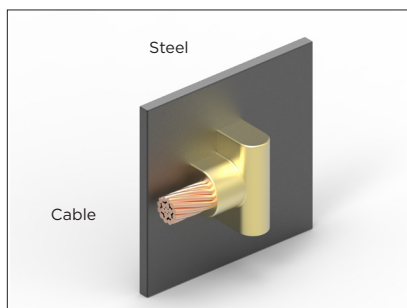

VSL

Cable Size	Flat Surface Mold Catalog Number	Vertical Pipe Mold Catalog Number	Weld Metal	Mold Price Key
#6 sol	VSL6S-A	VSL6S-PSA	45	A
#6	VSL6-A	VSL6-PSA	45	A
#4	VSL4-A	VSL4-PSA	45	A
#2 sol	VSL2S-A	VSL2S-PSA	45	A
#2	VSL2-A	VSL2-PSA	45	A
1/0	VSL1/0-A	VSL1/0-PSA	90	A
2/0	VSL2/0-A	VSL2/0-PSA	90	A
3/0	VSL3/0-A	VSL3/0-PSA	115	A
4/0	VSL4/0-A	VSL4/0-PSA	115	A
250 MCM	VSL250-A	VSL250-PSA	115	A
300 MCM	VSL300-A	VSL300-PSA	150	A
350 MCM	VSL350-A	VSL350-PSA	200	A
500 MCM	VSL500-A	VSL500-PSA	200	A

PS - add pipe size to mold part number here

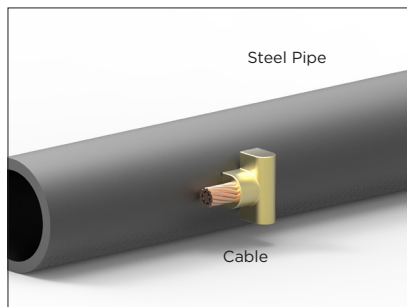

VSL

Cable to Steel Pipe (Types VSL)

Use flat surface mold part number with Pipe Size Indicator PS

Cable	Nominal Pipe Size	Pipe Size Indicator
#1 and Smaller	12 inches and Smaller	Nominal Pipe Size
	14 inches and larger	none
1/0 thru 500 MCM	28 inches and smaller	Nominal Pipe Size
	30 inches and larger	None

Example: 4/0 conductor to 6" Pipe - VSL4/0-6A
#2 Conductor to 14" Pipe - VSL2-A

Contact TE Connectivity for molds with other conductor sizes and configurations.

TE's AMP Weld exothermically welded connections meets the requirements of IEEE std. 837-2014.

VSR

**CABLE TO VERTICAL STEEL SURFACE/
PIPE**

- VSR makes a connection (off to the right) of a horizontal conductor to vertical flat steel or vertical side of a horizontal pipe.

GENERAL INFORMATION

- Molds shown are for concentric strand AWG conductors.
- Bare Class A, B, and C based on ASTM Standard Specifications
- Solid conductors are designated with a "S" suffix after the conductor
- Mold Price Key is the last letter in the Mold Catalog Number. i.e. A or B.
- For wear plates add the letter W to the end of the Mold Catalog Number

REQUIRED TOOLS

- Handle Clamps
- HCLAMP-3 (A Price Key Molds)
- Flint Ignitor -FLINT IGNITOR
- Mold Sealer - MOLD-SEALER

SUGGESTED TOOLS

- Cable Cleaning Brush -CC-BRUSH
- Slag Removal Spade - SLAG-SPADE
- Mold Cleaning Brush - MC-BRUSH
- Torch Head - EXO-TORCH
- Magnetic Clamp
- MHCLAMP-3 (A Price Key Molds)
- C-Clamp
- CCLAMP-3 (A Price Key Molds)

Cable Size	Flat Surface Mold Catalog Number	Vertical Pipe Mold Catalog Number	Weld Metal	Mold Price Key
#6 sol	VSR6S-A	VSR6S-PSA	45	A
#6	VSR6-A	VSR6-PSA	45	A
#4	VSR4-A	VSR4-PSA	45	A
#2 sol	VSR2S-A	VSR2S-PSA	45	A
#2	VSR2-A	VSR2-PSA	45	A
1/0	VSR1/0-A	VSR1/0-PSA	90	A
2/0	VSR2/0-A	VSR2/0-PSA	90	A
3/0	VSR3/0-A	VSR3/0-PSA	115	A
4/0	VSR4/0-A	VSR4/0-PSA	115	A
250 MCM	VSR250-A	VSR250-PSA	115	A
300 MCM	VSR300-A	VSR300-PSA	150	A
350 MCM	VSR350-A	VSR350-PSA	200	A
500 MCM	VSR500-A	VSR500-PSA	200	A

PS - add pipe size to mold part number here

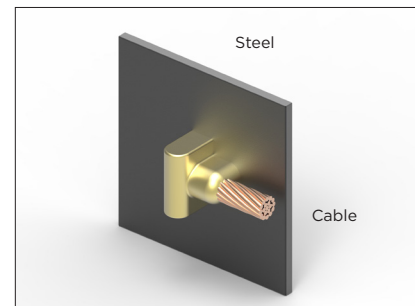

VSR

Cable to Steel Pipe (Types VSR)		
Use flat surface mold part number with Pipe Size Indicator PS		
Cable	Nominal Pipe Size	Pipe Size Indicator
#1 and Smaller	12 inches and Smaller	Nominal Pipe Size
	14 inches and Larger	None
1/0 thru 500 MCM	28 inches and Smaller	Nominal Pipe Size
	30 inches and Larger	None

Example: To the right a 4/0 conductor to 8" Pipe - VSR4/0-8A
To the right a #2 Conductor to 14" Pipe - VSR2-A

Contact TE Connectivity for molds with other conductor sizes and configurations.

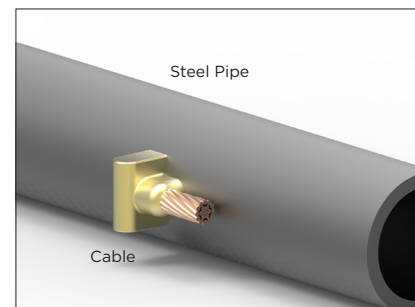

VSR

TE's AMP Weld exothermically welded connections meets the requirements of IEEE std. 837-2014.

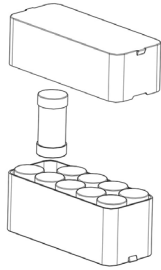

TE's AMP Weld Premium Weld Material (Metal)

TE's AMP Weld premium weld material is a proprietary blend of copper oxides, aluminum and alloy elements to produce the highest yield welds available. The welding and starting materials are packaged by size in double cavity plastic tubes. The two materials are in separate chambers which ensures there is NEVER intermixing of the welding and starting materials. Steel disks are packaged along with the tubes in plastic boxes. These materials are nonexplosive and are not subject to spontaneous combustion.

AMP Weld Premium Weld Material		
Catalog Number	RPN	Pk Qty
25WM	2182587-1	20
32WM	2182587-2	20
45WM	2182587-3	20
65WM	2182587-4	20
90WM	2182587-5	10
115WM	2182587-6	10
150WM	2182587-7	10
200WM	2182587-8	10
250WM	2182587-9	10

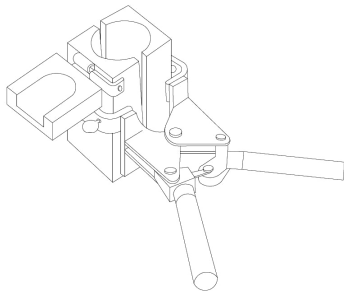

TE's AMP Weld Molds

TE's AMP Weld molds are precision engineered and machined to provide superior results in the field. Molds are produced from high quality graphite and components allowing them to withstand repetitive heat cycles. The minimum life of a mold is 60-70 connections but if cared for properly can make over 100 connections. Mold Price Keys are used to convey mold configuration and handle clamps required.

Mold Price Key	Description
A	3 inch Wide Mold
B	4 inch Wide Mold

*Fewer Price Keys makes ordering easy
Simplified Price Key structure significantly reduces cost to user*

Mold Handle Clamps

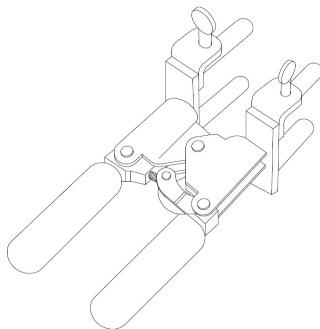

Catalog Number	Description
HCLAMP-3	Use for A Price Molds
HCLAMP-4	Use for B Price Molds

TE's AMP Weld exothermically welded connections meets the requirements of IEEE std. 837-2014.

Chain Handle Clamps

Chain Handle Clamps are available for making connections to vertical standing or horizontal pipes and beams.

Orientation	Catalog Number	Description
Horizontal	CHCLAMP-3H	Horizontal Chain Handle Clamp for A Priced Molds
	CHCLAMP-4H	Horizontal Chain Handle Clamp for B Priced Molds
Vertical	CHCLAMP-3V	Vertical Chain Handle Clamp for A Priced Molds
	CHCLAMP-4V	Vertical Chain Handle Clamp for B Priced Molds

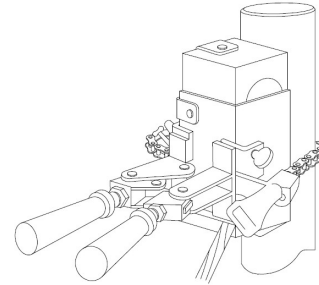

Magnetic Handle Clamps

Standard handle clamps fitted with powerful rare earth magnets to allow welding onto vertical flat steel surfaces.

Catalog Number	Description
MHCLAMP-3	Magnetic Handle Clamp for A Priced Molds
MHCLAMP-4	Magnetic Handle Clamp for B Priced Molds

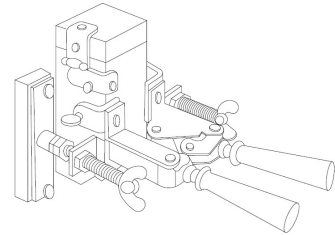

C-Clamp

These attachments will fit HCLAMP-3 and HCLAMP-4 handles to enable them to be attached to the edge of a flat vertical surface (i.e. I-beams, steel doors etc.), allowing the operator to have both hands free during welding. The attachment affixes to the center post of a handle clamp with a Cotter Pin.

Catalog Number	Description
CCLAMP-3	C-Clamp for use with HCLAMP-3
CCLAMP-4	C-Clamp for use with HCLAMP-4

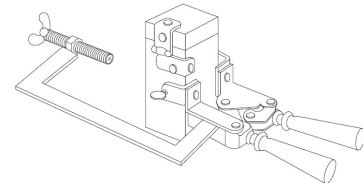

TE's AMP Weld exothermically welded connections meets the requirements of IEEE std. 837-2014.

Flint Ignitor

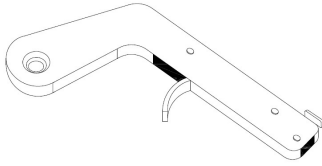

Compact and Convenient: These are mechanical flint ignitors with long service cycles. They produce a large cascade of sparks for ease of igniting the starting material. Worn flints can be replaced.

Catalog Number

FLINT-IGNITOR

Torch Head

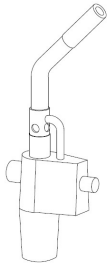

A very convenient flame torch for pre-heating of mold and conductors prior to making an AMP Weld exothermically welded connection. Self igniting propane torch head. Squeeze the control knob for instant flame. This torch uses cartridge type gas canisters.

Catalog Number

EXO-TORCH

Packaging Material

Most rebar connections require either Wrap Sleeve or Batting to prevent leakage. Batting is a preformed ceramic fiber blanket material. Wrap Sleeve is annealed copper shim stock.

Wrap Sleeve

Catalog Number

CUWRAP

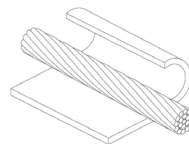

Batting

Catalog Number

CBATT-1

CBATT-2

CBATT-3

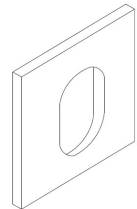

TE's AMP Weld exothermically welded connections meets the requirements of IEEE std. 837-2014.

Cable Clamp

Relieves tension from wires being welded to prevent the wires from pulling out of the mold during welding.

Catalog Number

CABLE-CLAMP

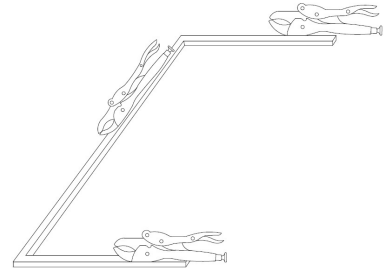

Exothermically
Welded
Grounding
Connections

Mold Brush

This heavy duty brush makes mold cleaning quick and easy. Hefty wooden handles stand up to repeated use. Stiff natural bristles ensure rapid mold cleaning without harming the soft graphite molds.

Catalog Number

MC-BRUSH

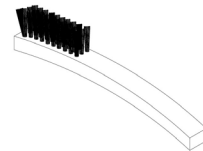

Slag spade

The Slag Spade tool has been designed to assist in the removal of slag from the mold crucible and tap hole.

Catalog Number

SLAG-SPADE

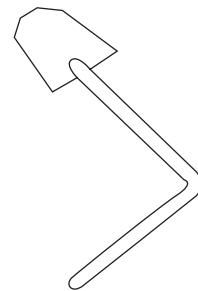

Wire Brush

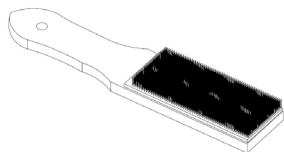

Short stiff wire bristles enable efficient cleaning of metal surfaces and wires in preparation for welding. Quality construction on wooden handles ensure long service life.

Catalog Number

CC-BRUSH

Weld Metal Disks

Weld Metal Disks are used to allow the exothermic reaction to occur in the crucible section of the mold. All weld material are packaged with the appropriate size disk but should additional disks be required they are available separate from the weld material.



Catalog Number	Diameter (in)	Weld Metal Size	Qty/Pkg
Disk 3/4	3/4	25 to 65	10
Disk 1	1	90 to 115	10
Disk 1-1/2	1 1/2	150 & Larger	10

Mold Sealer

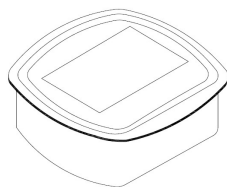

Mold Sealer is used for sealing hot or cold molds to prevent leakage around conductors for certain mold families. It also prolongs the life of the mold when the conductor openings become worn in the mold.

Catalog Number

MOLD-SEALER

TE's AMP Weld exothermically welded connections meets the requirements of IEEE std. 837-2014.

Terminal Lugs

Terminal lugs are made of electrolytic grade copper and are tinned plated. Provide terminations for grounding and power applications. NEMA Hole Patterns.

Type CLB Tinned Copper Lugs

Thickness & Width	No / Pkg	One Hole Lugs Catalog Number	Two Hole Lugs Catalog Number	Cross Section (MCM)
1/8 X 1	20	CL-1/8-1-1	CL-1/8-1-2	159
3/16 X 1	10	CL-3/16-1-1	CL-3/16-1-2	239
1/4 X 1	10	CL-1/4-1-1	CL-1/4-1-2	318
1/4 X 1-1/2	10	CL-1/4-1.5-1	CL-1/4-1.5-2	478

Uses mold family LBT

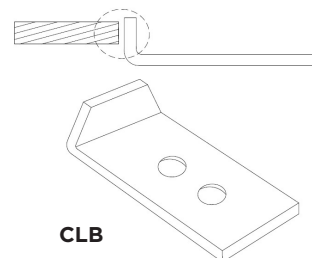

CLB

Type CLS Tinned Copper Lugs - Straight

Thickness & Width	No / Pkg	One Hole Lugs Catalog Number	Two Hole Lugs Catalog Number	Cross Section (MCM)
1/8 X 1	20	CS-1/8-1-1	CS-1/8-1-2	159
3/16 X 1	10	CS-3/16-1-1	CS-3/16-1-2	239
1/4 X 1	10	CS-1/4-1-1	CS-1/4-1-2	318
1/4 X 1-1/2	10	CS-1/4-1.5-1	CS-1/4-1.5-2	478
1/4 X 2	5	CS-1/4-2-1	CS-1/4-2-2	637
3/8 X 1-1/2	5	CS-3/8-1.5-1	CS-3/8-1.5-2	716
3/8 X 2	5	CS-3/8-2-1	CS-3/8-2-2	955
1/2 X 2	5	CS-1/2-2-1	CS-1/2-2-2	1374

Uses mold family LT

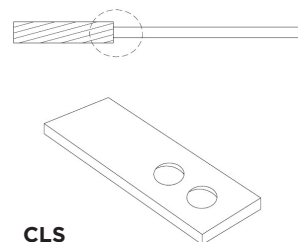

CLS

Type CLZ Tinned Copper Lugs - Offset

Thickness & Width	No / Pkg	One Hole Lugs Catalog Number	Two Hole Lugs Catalog Number	Cross Section (MCM)
1/8 X 1	20	CZ-1/8-1-1	CZ-1/8-1-2	159
3/16 X 1	10	CZ-3/16-1-1	CZ-3/16-1-2	239
1/4 X 1	10	CZ-1/4-1-1	CZ-1/4-1-2	318
1/4 X 1-1/2	10	CZ-1/4-1.5-1	CZ-1/4-1.5-2	478
1/4 X 2	10	CZ-1/4-2-1	CZ-1/4-2-2	637
3/8 X 1-1/2	5	CZ-3/8-1.5-1	CZ-3/8-1.5-2	716
3/8 X 2	5	CZ-3/8-2-1	CZ-3/8-2-2	955
1/2 X 2	5	CZ-1/2-2-1	CZ-1/2-2-2	1374

Uses mold family LT

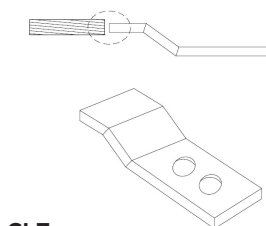

CLZ

Type CL4 Tinned Copper Lugs - Four Hole

Thickness & Width	No / Pkg	Straight Catalog Number	Offset Catalog Number	Cross Section (MCM)
1/4 X 3	5	CL4-1/4-3-5	CL4-1/4-3-OFF	955
3/8 X 3	5	CL4-3/8-3-5	CL4-3/8-3-OFF	1432
1/2 X 3	5	CL4-1/2-3-5	CL4-1/2-3-OFF	1910

Uses mold family LT

TE's AMP Weld exothermically welded connections meets the requirements of IEEE std. 837-2014.

Conductor Identification

Bare Class A, B, and C Concentric Stranded Conductors

Based on A.S.T.M Standard Specifications

Size in Circular mils	Size A.W.G.	Conductor Diameter	Number of Wires					Cable Code
			7	19	37	61	91	
1,000,000	1000	1.152		0.1470	0.1644	0.1280	0.148	1000
800,000	800	1.031		0.1424	0.1145	0.0938		800
750,000	750	0.998		0.1375	0.1109	0.0908		750
700,000	700	0.964		0.1273	0.1071	0.0877		700
600,000	600	0.893		0.1622	0.0992	0.0812		600
500,000	500	0.813		0.1451	0.1162	0.0905		500
400,000	400	0.728		0.1357	0.1040	0.0810		400
350,000	350	0.681		0.1257	0.0973	0.0757		350
300,000	300	0.630		0.1147	0.0900	0.0701		300
250,000	250	0.575		0.1055	0.0822	0.0640		250
211,600	4/0	0.528	0.1739	0.0940	0.0756			4/0
167,800	3/0	0.470	0.1548	0.0837	0.0763			3/0
133,100	2/0	0.419	0.1379	0.0745	0.0600			2/0
105,500	1/0	0.373	0.1228	0.0664	0.0534			1/0
83,690	1	0.332	0.1093	0.0591	0.0467			1
66,370	2	0.292	0.0974	0.0526				2
52,630	3	0.260	0.0867	0.0469				3
41,740	4	0.232	0.0772	0.0372				4
26,240	6	0.184	0.0612	0.0295				6
16,510	8	0.146	0.0486	0.0234				8
10,380	10	0.116	0.0385	0.0185				10
6,530	12	0.0915	0.0305	0.0417				12
4,110	14	0.0726	0.0242					14

All Dimensions in inches

CONDUCTOR AREA CONVERSIONS

Square Inches x 1273 = MCM
MCM x 7.856×10^{-4} = Square Inches

Square Millimeters x 1.9736 = MCM
MCM x 0.5067 = Square Millimeters

Square Inches x 645.2 = Square Millimeter
Square Millimeter x 1.550×10^{-3} = Square Inches

Bare Solid Copper Conductors

Based on A.S.T.M Standard Specifications

Size A.W.G.	Cross Sectional Area Circular Mils	Wire Diameter (in)	Cable Code
4/0	211,600	0.4600	4/0S
3/0	167,800	0.4096	3/0S
2/0	133,100	0.3648	2/0S
1/0	105,500	0.3249	1/0S
1	83,690	0.2893	1S
2	66,370	0.2576	2S
3	52,630	0.2294	3S
4	41,740	0.2043	4S
6	26,250	0.1620	6S
8	16,510	0.1285	8S
10	10,380	0.1019	10S
12	6,530	0.0808	12S
14	4,110	0.0641	14S

Exothermically
Welded
Grounding
Connections

Copper-Clad Steel Conductors

Cable Code	Cable Stranding	Nominal Diameter (in.)	Cross Sectional Area (kcmil)
3/10CW	3/#10 CW	0.220	31.15
3/9CW	3/#9 CW	0.247	39.28
3/8CW	3/#8 CW	0.277	49.53
7/10CW	7/#10 CW	0.306	72.68
3/7CW	3/#7 CW	0.311	62.45
7/9CW	7/#9 CW	0.343	91.65
3/6CW	3/#6 CW	0.349	78.75
7/8CW	7/#8 CW	0.385	115.60
3/5CW	3/#5 CW	0.392	99.31
7/7CW	7/#7 CW	0.433	145.70
7/6CW	7/#6 CW	0.486	183.80
7/5CW	7/#5 CW	0.546	231.63
19/9CW	19/#9 CW	0.572	248.70
7/4CW	7/#4 CW	0.613	292.20
19/8CW	19/#8 CW	0.642	313.70
19/7CW	19/#7 CW	0.721	395.60
19/6CW	19/#6 CW	0.810	498.60
19/5CW	19/#5 CW	0.910	628.70

Steel Pipe Sizes

Standard Weight (Schedule 40)

Nominal Size (in)	O.D. (in)	Wall Thickness (in)	Pipe Code
1	1.315	0.133	1
1 1/4	1.66	0.14	1.25
1 1/2	1.9	0.145	1.5
2	2.375	0.154	2
2 1/2	2.875	0.203	1.5
3	3.5	0.216	3
3 1/2	4	0.226	3.5
4	4.5	0.237	4
5	5.563	0.258	5
6	6.625	0.28	6
8	8.625	0.322	8
10	10.75	0.365	10

ASTM A53-90-B

ANSI/ASME B36.10M-1985

Ground Rods

Nominal Size (in)	Material	Type	Body Diameter (in)	Thread Size (in)	Ground Rod Designation
1/2	Copper-clad	Sectional	0.505	9/16	1/2S
	Copper-clad	Plain	0.500	N/A	1/2
	Steel	Plain	0.500	N/A	1/2
	Copper-clad	Plain	0.475	N/A	1/2N
5/8	Steel	Plain	0.625	N/A	5/8F
	Copper-clad	Plain	0.563	N/A	5/8
	Copper-clad	Sectional	0.563	5/8	5/8S
3/4	Steel	Plain	0.750	N/A	3/4F
	Copper-clad	Plain	0.682	N/A	3/4
	Copper-clad	Sectional	0.682	3/4	3/4S
1	Steel	Plain	1.00	N/A	1F
	Copper-clad	Plain	0.914	N/A	1
	Copper-clad	Sectional	0.914	1	1S

Rectangular Copper Busbar

Thickness (in)	Width (in)	Circular Mil Size	Weight Lbs/Foot	Busbar Code
1/8	1	159,200	0.484	1/8X1
	1 1/2	238,700	0.726	1/8X1.5
	2	318,300	0.969	1/8X2
3/16	1	238,700	0.727	3/16X1
	2	477,500	1.45	3/16X2
1/4	1	318,300	0.969	1/4X1
	1 1/2	477,500	1.45	1/4X1.5
	2	636,600	1.94	1/4X2
	3	954,900	2.91	1/4X3
	4	1,273,000	3.88	1/4X4
3/8	1	477,500	1.45	3/8X1
	1 1/2	716,200	2.18	3/8X1.5
	2	954,900	2.91	3/8X2
	3	1,432,000	4.36	3/8X3
	4	1,910,000	5.81	3/8X4
1/2	2	1,273,000	3.88	1/2X2
	3	1,910,000	5.81	1/2X3
	4	2,546,000	7.75	1/2X4

Exothermically
Welded
Grounding
Connections

Reinforcing Bars

Rebar Sizes	Nominal Dimensions		Equivalent Copper Sizes	Rebar Code
	Diameter (in)	Cross-sectional Area-Sq. (in)		
3	0.375	0.110	9 AWG	3
4	0.500	0.20	7	4
5	0.625	0.310	5	5
6	0.750	0.440	3	6
7	0.875	0.600	2	7
8	1.00	0.790	1	8
9	1.128	1.00	1/0	9
10	1.270	1.270	2/0	10
11	1.410	1.560	3/0	11
14	1.693	2.250	250 MCM	14
18	2.257	4.00	450 MCM	18



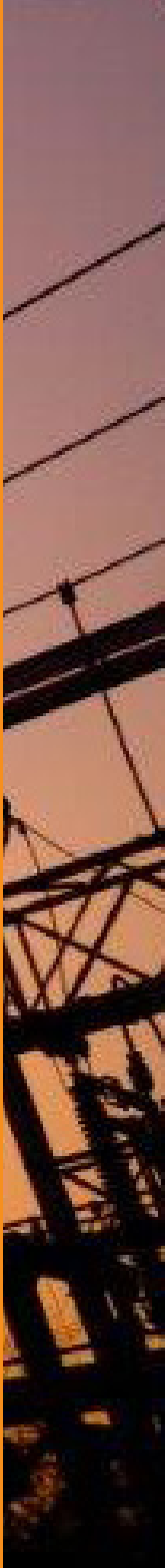

Chapter 2 Copper Wire Taps

TE'S AMPACT COPPER WEDGE CONNECTORS	
COPPER WIRE TAPS	74
TOOLS AND ACCESSORIES	
AMPACT TOOLS	77
Lead Free Cartridges	79
Cleaning Tools	79

TE's AMPACT Copper Wedge Connectors

FEATURES

- Wedge Technology
- Corrosion Resistant
- Low resistance grounding connections
- Optimum electrical contact
- Visual Inspection

APPLICATIONS

- For use in substations, transmission grounding and distribution grounding as well as overhead applications
- Electrical joints are stable and effective for optimum electrical contact, even under conditions of creep and cold flow
- Telco distribution, CATV grounds
- Compression pin connectors and cold and heat shrink terminations can be purchased as a kit

BENEFITS

- Unique design and simple installation system provides firm, sure contact for consistent, all weather, wire-to-wire, low resistance grounding connections
- TE's AMPACT copper taps are made of quality allows for low resistivity and superior corrosion resistance
- Compact, lightweight application tool permits easy installation almost anywhere, without bulky equipment, heat or external power
- Taps will not penetrate copper plating, allowing secure connections from copper conductors to ground rods, reinforcing bars or conductors of any type
- Connectors may be checked visually - speeding inspection and practically eliminating callbacks

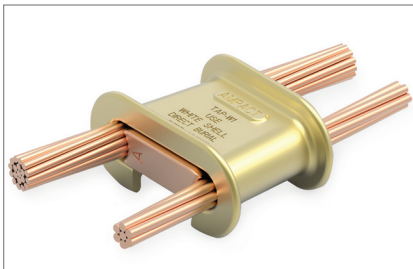

PRODUCT SELECTION INFORMATION

Groove Size kcmil or AWG	Groove Code	Conductor Diameter inches (mm)	
		Min	Max
500	A	.785 (19.9)	.813 (20.7)
450	B	.745 (18.9)	.784 (19.9)
400	E	.700 (17.8)	.744 (18.9)
350	G	.650 (16.5)	.699 (17.8)
300	H	.620 (15.7)	.649 (16.5)
250	K (R) ^{††}	.561 (14.2)	.625 (15.9)
4/0	L	.506 (12.9)	.560 (14.2)
3/0	M	.451 (11.5)	.505 (12.8)
2/0	N	.401 (10.2)	.450 (11.4)
1/0	O	.355 (9.0)	.400 (10.2)
No. 2	T	.280 (7.1)	.354 (9.0)
No. 4	W	.216 (5.5)	.279 (7.1)
No. 6	X	.182 (4.6)	.215 (5.5)

AMPACT COPPER TAP SELECTION FOR WIRE TO GROUND ROD[†] OR SOLID PIN

Copper Conductor (kcmil/AWG)	3/8"	1/2"	5/8"	3/4"		
	Ground Rod/Pin Dia. Range .355-.375 (9.02-9.53)	Ground Rod/Pin Dia. Range .475-.500 (12.07-12.7)	Ground Rod Dia. .563 (14.3)	Ground Rod/Pin Dia. .625 (15.88)	Ground Rod Dia. .682 (17.32)	Ground Rod/Pin Dia. .750 (19.05)
500	1-276337-4	1-276337-3	276337-9	1-276337-2	1-276337-1	276337-1
450	2-276337-5	2-276337-4	2-276337-3	2-276337-2	2-276337-1	1-276337-9
400	3-276337-7	3-276337-5	3-276337-3	3-276337-2	3-276337-1	2-276337-0
350	4-276337-9	4-276337-7	4-276337-5	4-276337-4	4-276337-3	2-276337-1
300	6-276337-0	5-276337-8	5-276337-6	5-276337-5	4-276337-4	2-276337-2
250	275187-4	275187-2	2-275187-8	5-276337-6	4-276337-5	2-276337-3
4/0	275187-9	275187-7	275187-1	5-276337-7	4-276337-6	276337-2
3/0	1-275187-3	1-275187-1	275187-2	5-276337-8	4-276337-7	2-276337-4
2/0	1-275187-6	1-275187-2	275187-3	5-276337-9	4-276337-8	276337-3
1/0	1-275187-8	1-275187-3	275187-4	6-276337-0	4-276337-9	2-276337-5
No. 2	277060-1	1-275187-4	275187-5	6-276337-2	5-276337-1	276337-4
No. 4	277060-1,2,3	3-275187-6	3-275187-0	6-276337-4	5-276337-3	2-276337-8
No. 6	277060-2	3-275187-7	3-275187-1	6-276337-5	5-276337-4	2-276337-9

AMPACT COPPER TAP SELECTION FOR WIRE-TO-WIRE APPLICATIONS

Typical Example:

500 to 350 kcmil = Groove Code AG = Part No. 1-276337-1

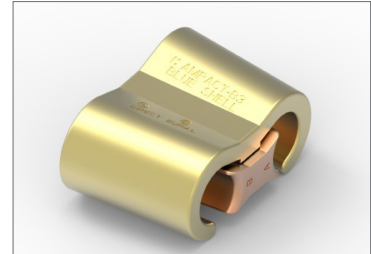
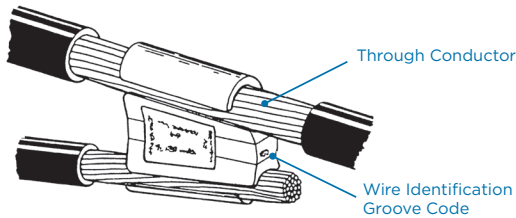
Copper
Wire Taps

Wire Size	White Shells (69338-5)								Blue Shells (69338-1)					Yellow Shells (69338-4)
	X 5,6	W 4	T 2	O 1/0	N 2/0	M 3/0	L 4/0	K (R) 250	H 300	G 350	E 400	B 450	A 500	750 (61)
X 5,6	2182410-4	2182410-4	2182410-2	2182410-2	4-275187-0	3-275187-7	3-275187-4	3-275187-1	6-276337-5	5-276337-4	4-276337-2	2-276337-9	1-276337-8	1-81723-3*
W 4		2182410-3	2182410-2	2182410-1	3-275187-9	3-275187-6	3-275187-3	3-275187-0	6-276337-4	5-276337-3	4-276337-1	2-276337-8	1-276337-7	1-81723-3*
T 2			2182410-1	2182410-1	1-275187-7	1-275187-4	1-275187-0	275187-5	6-276337-2	5-276337-1	3-276337-9	276337-4	276337-8	1-81723-2*
O 1/0				1-275187-8	1-275187-6	1-275187-3	275187-9	275187-4	6-276337-0	4-276337-9	3-276337-7	2-276337-5	1-276337-4	1-81723-2*
N 2/0					1-275187-5	1-275187-2	275187-8	275187-3	5-276337-9	4-276337-8	3-276337-6	276337-3	276337-7	1-81723-1*
M 3/0						1-275187-1	275187-7	275187-2	5-276337-8	4-276337-7	3-276337-5	2-276337-4	1-276337-3	1-81723-0*
L 4/0							275187-6	275187-1	5-276337-7	4-276337-6	3-276337-4	276337-2	276337-6	81723-9*
K (R) 250								2-275187-8	5-276337-6	4-276337-5	3-276337-3	2-276337-3	276337-9	81723-8*
H 300									5-276337-5	4-276337-4	3-276337-2	2-276337-2	1-276337-2	81723-7
G 350										4-276337-3	3-276337-1	2-276337-1	1-276337-1	81723-6
E 400											3-276337-0	2-276337-0	1-276337-0	81723-5
B 450												1-276337-9	276337-1	81723-4
A 500													276337-5	81723-2
750 (61)														81723-1

GROUND ROD APPLICATIONS, COPPER-CLAD

Designated Size	Wire Size	Actual Diameter
3/8 (9.53)	1/0 AWG	.355 (9.02)
1/2 (12.70)	3/0 AWG	.475 (12.06)
5/8 (15.88)	250 kcmil	.563 (14.30)
3/4 (19.05)	350 kcmil	.682 (17.32)

Galvanized Steel		
3/8 (9.53)	1/0 AWG	.375 (9.53)
1/2 (12.70)	3/0 AWG	.500 (12.70)
5/8 (15.88)	300 kcmil	.625 (15.88)
3/4 (19.05)	450 kcmil	.750 (19.05)



Sizes 2/0 < listed by Underwriters
Laboratories Inc., File No. E69905



Certified by Canadian Standards
Association, File No. LR 56476
REA Letter of Technical Acceptance
(Grounding Taps)

TE's AMPACT copper taps have been tested for the most severe service environment that they would normally be exposed to under both distribution and grounding applications. They have been tested to meet or exceed the requirements of ANSI C119.4-2011

TE's AMPACT copper taps have been tested at 32,000 amps symmetrical RMS (72kA peak) for 0.5 seconds on 4/0 copper conductor per IEEE 837. TE's AMPACT Copper Tap meets all mechanical requirements of ANSI C119.4 and is rated as a Class 3 minimum-tension connector.

One of the most severe requirements placed on a connector for below grade grounding applications is corrosion resistance. In order to make our corrosion testing more severe and more realistic, we first subject the electrical connections to thermal shock. Our procedure for subjecting a connector to thermal shock is as follows:

Thermal Shock Test Sequence

TE Specification 109-13009

Each cycle = 24 hours in following sequence;

- i) 150 minutes in oven at 150°C
 - ii) 15 minutes in ice water at 0°C
 - iii) 30 minutes in oven at 150°C
 - iv) 20-3/4 hours at room ambient
- (Test repeated for 5 complete cycles)

TE'S AMPACT Copper Wire Taps

Tap	Cartridge
275187-1	69338-5
275187-2	69338-5
275187-3	69338-5
275187-4	69338-5
275187-5	69338-5
275187-6	69338-5
275187-7	69338-5
275187-8	69338-5
275187-9	69338-5
1-275187-0	69338-5
1-275187-1	69338-5
1-275187-2	69338-5
1-275187-3	69338-5
1-275187-4	69338-5
1-275187-5	69338-5
1-275187-6	69338-5
1-275187-7	69338-5
1-275187-8	69338-5
2-275187-8	69338-5
3-275187-0	69338-5
3-275187-1	69338-5
3-275187-3	69338-5
3-275187-4	69338-5
3-275187-6	69338-5
3-275187-7	69338-5
3-275187-9	69338-5
4-275187-0	69338-5
276337-1	69338-1
276337-2	69338-1
276337-3	69338-1
276337-4	69338-1
276337-5	69338-1
276337-6	69338-1
276337-7	69338-1
276337-8	69338-1
276337-9	69338-1
1-276337-0	69338-1
1-276337-1	69338-1
1-276337-2	69338-1
1-276337-3	69338-1
1-276337-4	69338-1
1-276337-7	69338-1
1-276337-8	69338-1

Tap	Cartridge
1-276337-9	69338-1
2-276337-0	69338-1
2-276337-2	69338-1
2-276337-3	69338-1
2-276337-4	69338-1
2-276337-5	69338-1
2-276337-8	69338-1
2-276337-9	69338-1
3-276337-0	69338-1
3-276337-1	69338-1
3-276337-2	69338-1
3-276337-3	69338-1
3-276337-4	69338-1
3-276337-5	69338-1
3-276337-6	69338-1
3-276337-7	69338-1
3-276337-9	69338-1
4-276337-1	69338-1
4-276337-2	69338-1
4-276337-3	69338-1
4-276337-4	69338-1
4-276337-5	69338-1
4-276337-6	69338-1
4-276337-7	69338-1
4-276337-8	69338-1
4-276337-9	69338-1
5-276337-1	69338-1
5-276337-3	69338-1
5-276337-4	69338-1
5-276337-5	69338-1
5-276337-6	69338-1
5-276337-7	69338-1
5-276337-8	69338-1
5-276337-9	69338-1
6-276337-0	69338-1
6-276337-2	69338-1
6-276337-4	69338-1
6-276337-5	69338-1
277060-1	69338-2
277060-2	69338-2
277060-3	69338-2
277060-4	69338-2

Tools

FEATURES

- Conductor applications imprinted on tap packages
- Packages and labels color coded to match taps to tools and cartridges

APPLICATIONS

- Installs and removes taps even in confined spaces

BENEFITS

- ♦ Adaptable for standard hot-stick use
- ♦ Lightweight powder-actuated tools require minimum operator effort

Copper Wire Taps

Product Selection Information

Catalog Number	Product Description	Connects
69437	Small AMPACT Tool (Red, White, and Blue coded taps)	#8-500 MCM Copper Tap Series
69611	Large AMPACT Tool (Yellow-coded taps only)	750-1000 MCM Copper Tap Series



AMPACT Tool

Replacement parts

Catalog Number	Description
69633-2	Large Tool Head
47667-8	Small Tool Head
69612	Universal Power Unit
308967-1	Breech Assembly
314196-1	Breech Cap Assembly (3-Pc)
5-304668-3	Retaining Spring



69633-2



314196-1, 5-304668-3



308967-1



47667-8



69612

AMPACT EZLoad

FEATURES

- TE's AMPACT EZLoad tool is a precision designed, powder actuated tool that is robust yet lightweight.
- The tool is designed with a lock and load approach.
- The cartridges are molded of weatherproof polyethylene and packed with propellant and primer.
- The color of the cartridge indicates the strength of the powder charge and corresponds to the color-code of tap sizes with which they are used.

APPLICATIONS

- AMPACT cartridges are color-coded (red etc.) and designed specifically for use in TE's AMPACT EZLoad tools to install TE's AMPACT taps

BENEFITS

- ♦ This all in one design hinges on the power unit and is easily opened and closed to replace the cartridges.
- ♦ TE's AMPACT tools are engaged by firing a special powder loaded cartridge within the tool which reduces the time and effort required to tap a power line.
- ♦ The compact tools are manufactured in high-grade steel to precise tolerances and are available in two sizes: large head and small head. The same interchangeable power unit is used in both tools.

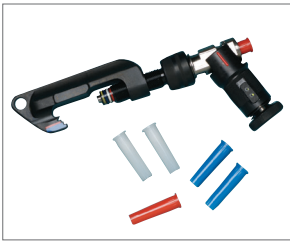

AMPACT EZLoad

PRODUCT SELECTION INFORMATION

Catalog Number	Description
1043413-1	EZLoad Small tool
1443414-1	EZLoad Large tool
1443413-2	EZLoad Power k Adapter
1443514-1	EZLoad Hot-Stick Adapter Kit (includes Piercer pin guide and cover)
1443470-1	EZLoad Hot-Stick Adapter with Power Unit
1443442-1	EZLoad Cleaning tool
1443448-1	EZLoad Tool repair kit (included Piercer Pin guide, Piercer pin and grub screw)
69610-2	Hot-stick Kit for EZLoad tool

Lead Free Cartridges

PRODUCT SELECTION INFORMATION

Catalog Number	Description
69338-5	White
69338-2	Red
69338-1	Blue
69338-4	Yellow

Cartridges

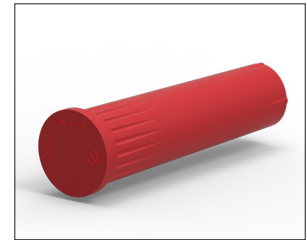
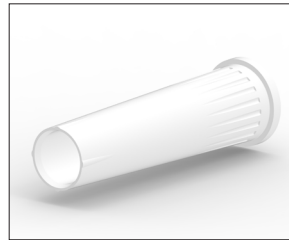
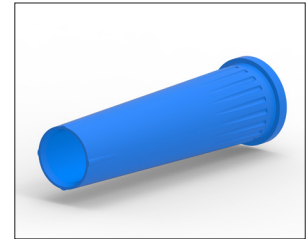
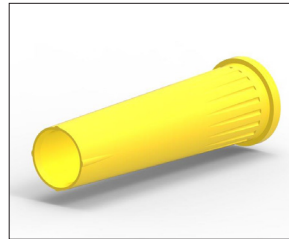
Copper
Wire Taps

Cleaning Tools

PRODUCT SELECTION INFORMATION

Catalog Number	Description
314199-1	Universal Cleaning Tool
1443442-1	Ezload Cleaning Tool

Cleaning Tool

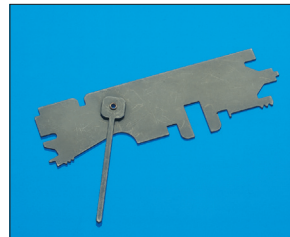



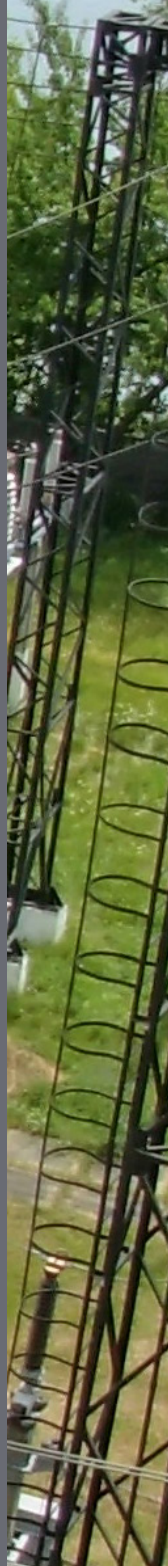

Chapter 3 Bolted Wedge Ground Connectors

WRENCH-LOK Conectors	82
SHEAR-LOK Conectors	86

WRENCH-LOK Grounding Connector

FEATURES

- Uses a specially designed shear-head bolt to drive a tapered wedge into the connector body
- WRENCH-LOK connectors require no special training, no special tools, no auxiliary power, and they can be installed in any weather.

APPLICATIONS

- The product line offers options to connect conductor- to-conductor or conductor-to-ground rod.

BENEFITS

- ♦ Provides a superior, fool-proof connection while reducing application time dramatically
- ♦ All that's needed to apply it is a common ratchet or socket wrench
- ♦ When the connection is tightened to the proper torque, the bolt head shears off, giving a positive visual indication of a perfect connection
- ♦ No need to change connector styles, molds or tooling

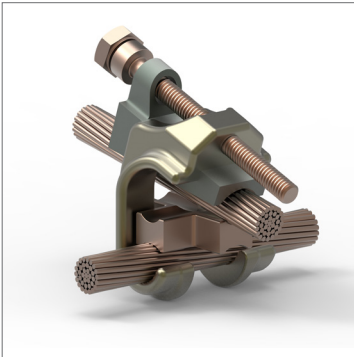

Listed by Underwriters Laboratories Inc.,
File No. E69905

REA

Meets requirements of IEEE STD 837

Certified by Canadian Standards
Association, File No. LR56476

Technical Document
Department Publication: 410-5812
Instruction Sheet: 408-9504

Test Results for Copper Ground Grid Connectors

IEEE Standard 837

Overall, connectors meet all requirements necessary to be considered qualified for permanent grounding connections used in substation grounding.

A. Mechanical Pullout

Connectors exceeded min. standard pullout requirements by wide margin.

B. Electromagnetic Force

Connectors withstood high mechanical and heating stresses of short circuit currents, well within standard.

C. Sequential Tests

1. Current-Temperature Cycling

Connectors ran much cooler than control conductor and resistance remained low and stable.

2. Freeze-Thaw

Resistance of connectors remained stable, demonstrating connectors are not affected by extreme temp. changes.

3. Corrosion-Nitric Acid

Acid did not penetrate contact interface and resistance remained stable.

4. Fault Current

Connectors withstood severe mechanical and heating stresses with very slight increase in joint resistance, well within standard.

Thermal Shock and Accelerated Stable Performance indicates connectors will not be adversely affected by extreme corrosion environmental conditions.

Torque of Bolt vs. Resistance

Connection resistance stable at point much below nominal torque of connection

Torque of Bolt vs. Deflection

Connector designed with sufficient strength and spring qualities to maintain body resilient contact force for dependable, long-term connection.

Tensile vs. Deflection

Connector body designed with sufficient strength to withstand extreme overload mechanical forces.

WRENCH-LOK CONNECTORS SELECTION CHARTS

Ground rod-to-conductor

3/8		1/2		5/8		3/4		Conductor
Copper Clad .355 (9.02)	Galv. Steel .375 (9.52)	Copper Clad .475 (12.06)	Galv. Steel .500 (12.70)	Copper Clad .563 (14.30)	Galv. Steel .625 (15.88)	Copper Clad .682 (17.32)	Galv. Steel .750 (19.05)	
83747-2	83747-2	83747-4	83747-4	83749-1	83749-2	83749-3	83749-4	#2 sol, str, cmpt
83747-3	83747-3	83749-1	83749-1	83749-2	83749-3	83748-3	83748-3	1/0 str, cmpt
83747-4	83747-4	83749-2	83749-2	83749-3	83748-1	83748-3	83748-4	2/0 str, cmpt
		83749-2	83749-3	83748-1	83748-2	83748-4	83751-1	3/0 str, cmpt
		83748-1	83748-1	83748-2	83748-4	83751-1	83751-2	4/0 str, cmpt
				83750-1	83748-4	83751-1	83751-2	250 compacted
				83750-1	83751-1	83751-2	83751-3	250 str
					83751-1	83751-2	83751-3	300 compacted
					83751-2	83751-3	83751-4	300 str
					83751-2	83751-3	83751-4	350 compacted
						83751-3	83750-2	350 str
						83751-3	83751-4	400 compacted
							83750-3	500 str

Conductor-to-Conductor (Standard Round)

#2 sol, str	1/0 str	2/0 str	3/0 str	4/0 str	250 str	300 str	350 str	400 str	500 str	Conductor
83747-1	83747-2	83747-2	83747-3	83747-4	83747-1	83749-2	83749-3	83749-4	-	#2 sol, str
	83747-3	83747-3	83747-4	83749-1	83749-2	83749-3	83748-1	83749-3	83751-1	1/0 str
		83747-4	83749-1	83749-2	83749-3	83748-1	83748-2	83748-3	83751-1	2/0 str
			83749-2	83749-3	83748-1	83748-2	83748-3	83748-4	83751-2	3/0 str
				83748-2	83748-2	83748-4	83751-1	83751-1	83751-3	4/0 str
					83750-1	83751-1	83751-2	83751-2	83751-4	250 str
						83750-2	83751-2	83751-3	83750-2	300 str
							83751-3	83751-4	83750-3	350 str
								83750-2	83750-5	400 str
									83750-4	450 str
									83750-6	500 str

Conductor-to-Conductor (Compacted)

#2	1/0	2/0	3/0	4/0	250	300	350	400	500 str	Conductor
83747-1	83747-2	83747-2	83747-3	83747-4	83747-4	83749-1	83749-2	83749-3	83749-4	#2
	83747-3	83747-3	83747-4	83749-1	83749-2	83749-2	83749-3	83749-1	83749-3	1/0
		83747-4	83747-1	83749-2	83749-2	83749-3	83748-1	83748-2	83748-4	2/0
			83749-2	83749-3	83748-1	83748-1	83748-2	83748-3	83751-1	3/0
				83748-1	83748-2	83748-2	83748-4	83748-4	83751-1	4/0
					83750-1	83750-1	83748-4	83751-1	83751-2	250
						83750-1	83751-1	83751-1	83751-3	300
							83751-2	83751-2	83751-3	350
								83751-3	83749-4	400
									83750-2	450
									83750-3	500

Replacement Bolts Part Numbers

Small Body 81249-4
Large Body 81249-2

Conductors listed are for Stranded Copper Standard Round

WRENCH-LOK CONNECTORS SELECTION CHARTS

Catalog Number Small Body	Description Standard Round	Compacted	Conductor to Ground Rod
83747-1	#2 sol., str.-#2 sol., str.	2-#2	
83747-2	1/0, 2/0 str.-#2 sol., str.	1/0, 2/0-#2	3/8 Clad or Galv.-#2
83747-3	1/0, 2/0 str.-1/0 str.	1/0, 2/0-1/0	3/8 Clad or Galv.-1/0
	3/0 str.-#2 sol., str.	3/0-#2	
83747-4	2/0 str.-2/0 str.	2/0-2/0	3/8 Clad or Galv.-2/0
	3/0 str.-1/0 str.	3/0-1/0	1/2 Clad or Galv.-#2
	4/0 str.-#2 sol., str.	4/0, 250-#2	
83749-1	3/0 str.-#2 str.	3/0-2/0	1/2 Clad or Galv.-1/0
	4/0 str.-1/0 str.	4/0-1/0	5/8 Clad - #2
	250 str.-#2 sol., str.	300-#2	
83749-2	3/0 str.-3/0, str.	3/0-3/0	1/2 Clad or Galv.-2/0
	4/0 str.-2/0 str.	4/0, 250-2/0	5/8 Clad-1/0
	250 str.-1/0 str.	250/300-1/0	5/8 Galv.-#2
	300 str.-#2 sol., str.	350-#2	
83749-3	4/0 str.-3/0 str.	4/0-3/0	1/2 Clad or Galv.-3/0
	250 str.-2/0 str.	300-2/0	5/8 Clad-2/0
	300 str.-1/0 str.	350-1/0	5/8 Galv.-1/0
	350 str.-#2 sol., str.	400, 450-#2	3/4 Clad-#2
83748-1	4/0 str.-4/0 str.	4/0-4/0	1/2 Clad or Galv.-4/0
	250 str.-3/0 str.	250, 300-3/0	5/8 Clad-3/0
	300 str.-2/0 str.	350-2/0	5/8 Galv.-2/0
	350 str.-1/0 str.	400-1/0	
83748-2	4/0 str.-4/0 str.	250, 300-4/0	5/8 Clad-4/0
	300 str.-3/0 str.	350-3/0	5/8 Galv.-3/0
	350 str.-2/0 str.	400-2/0	
83749-4	400, 450 str.-#2 sol., str.	450-1/0	3/4 Clad-1/0
		500-#2	3/4 Galv.-#2
83748-3	350 str.-3/0 str.	400-3/0	3/4 Clad-2/0
	400 str.-2/0, 1/0 str.	450-2/0	3/4 Galv.-1/0
	450 str.-1/0 str.	500-1/0	
83748-4	300 str.-4/0 str.	350-4/0, 250	5/8 Galv.-4/0
	400 str.-3/0 str.	400-4/0	5/8 Galv.-250 cmpt.
	450 str.-2/0 str.	450-3/0	3/4 Clad-3/0
		500 - 2/0	3/4 Galv.-2/0
83750-1	250 str.-250 str.	250, 300-250, 300	5/8 Clad-250 str., cmpt.
	300 str.-250 str.	350, 400-300	5/8 Galv.-250 str., 300 cmpt.
	350, 400 str.-4/0 str.	400-250	3/4 Clad-4/0, 250 cmpt.
	450 str.-3/0 str.	450-4/0	3/4 Galv.-3/0
	500 str. - 2/0 str.	500-3/0	
83751-2	300, 350 str.-300 str.	350, 400-350	5/8 Galv.-350 cmpt, 300 str.
	350, 400 str.-250 str.	450-300, 250	3/4 Clad-250 str., 300 cmpt.
	450 str.-4/0 str.	500-250	3/4 Galv.-4/0, 250 cmpt.
	500 str.-3/0 str.		
83751-3	350 str.-350 str.	400-400	3/4 Clad-300 str., 350 cmpt, str., 400 cmpt.
	400 str.-300 str.	450-350	3/4 Galv.-250 str., 300 cmpt.
	450 str.-250 str.	500-350, 300	
	500 str.-4/0 str.		
83751-4	400 str.-350 str.	400, 500-400	3/4 Galv.-300 str., 350 cmpt, 400 cmpt.
	450 str.-300 str.		
	500 str.-250 str.		
83750-2	400 str.-400 str.	450, 500-450	3/4 Galv.-350 str., 450 cmpt.
	450 str.-350 str.		
	500 str.-300 str.		
83750-3	450 str.-400 str.	500-500	3/4 Galv.-400 str., 500 cmpt.
	450 str.-400 str.		
	500 str.-350 str.		
83750-5	450 str.-450 str.		
	500 str.-400 str.		
83750-4	500 str.-450 str.		
83750-6	500 str.-500 str.		

WRENCH-LOK CONNECTORS SELECTION CHARTS

IMPERIAL	Sum of Diameters		Large Wire		Small Wire	
	Max.	Min.	Max.	Min.	Max.	Min.
83747-1	0.595	0.500	0.296	0.204	0.296	0.204
83747-2	0.706	0.594	0.420	0.298	0.296	0.204
83747-3	0.782	0.672	0.470	0.302	0.370	0.258
83747-4	0.832	0.733	0.520	0.313	0.420	0.258
83749-1	0.89	0.799	0.630	0.423	0.470	0.258
83749-2	0.942	0.846	0.630	0.423	0.470	0.258
83749-3	1.003	0.898	0.700	0.470	0.470	0.258
83748-1	1.050	0.943	0.700	0.470	0.700	0.292
83748-2	1.099	0.995	0.700	0.470	0.522	0.295
83749-4	1.068	0.964	0.770	0.500	0.470	0.258
83748-3	1.146	1.042	0.770	0.500	0.520	0.292
83748-4	1.192	1.086	0.770	0.500	0.520	0.316
83750-1	1.148	1.04	0.580	0.460	0.580	0.460
83751-1	1.250	1.147	0.815	0.572	0.575	0.336
83751-2	1.311	1.212	0.815	0.582	0.630	0.414
83751-3	1.374	1.288	0.815	0.606	0.682	0.473
83751-4	1.419	1.342	0.815	0.660	0.682	0.527
83750-2	1.464	1.400	0.815	0.670	0.730	0.585
83750-3	1.510	1.446	0.815	0.676	0.770	0.631
83750-5	1.546	1.495	0.815	0.680	0.815	0.680
83750-4	1.580	1.538	0.815	0.723	0.815	0.723
83750-6	1.620	1.578	0.815	0.763	0.815	0.763

Bolted
Wedge
Ground
Connectors

METRIC	Sum of Diameters		Large Wire		Small Wire	
	Max.	Min.	Max.	Min.	Max.	Min.
83747-1	15.113	12.700	7.518	5.182	7.518	5.182
83747-2	17.932	15.088	10.668	7.569	7.518	5.182
83747-3	19.863	17.069	11.938	7.671	9.398	6.553
83747-4	21.133	18.618	13.208	7.950	10.668	6.553
83749-1	22.606	20.295	16.002	10.744	11.938	6.553
83749-2	23.927	21.488	16.002	10.744	11.938	6.553
83749-3	25.476	22.809	17.780	11.938	11.938	6.553
83748-1	26.670	23.952	17.780	11.938	17.780	7.417
83748-2	27.910	25.273	17.780	11.938	13.259	7.493
83749-4	27.127	24.486	19.558	12.700	11.938	6.553
83748-3	29.108	26.467	19.558	12.700	13.208	7.417
83748-4	30.277	27.584	19.558	12.700	13.208	8.026
83750-1	29.159	26.416	14.732	11.684	14.732	11.684
83751-1	31.750	29.134	20.701	14.529	14.605	8.534
83751-2	33.299	30.785	20.701	14.783	16.002	10.516
83751-3	34.900	32.715	20.701	15.390	17.323	12.014
83751-4	36.043	34.087	20.701	16.764	17.323	13.386
83750-2	37.186	35.56	20.701	17.018	18.542	14.859
83750-3	38.354	36.728	20.701	17.170	19.558	16.027
83750-5	39.268	37.973	20.701	17.272	20.701	17.272
83750-4	40.132	39.065	20.701	18.364	20.701	18.364
83750-6	41.148	40.081	20.701	19.380	20.701	19.38

SHEAR-LOK Grounding Connector

FEATURES

- Wedge Pressure Technology
- Shear-head bolt—controlled torque
- Removable without conductor damage
- No special tools

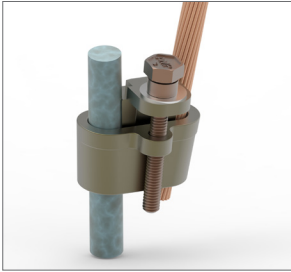

APPLICATIONS

- This family of connectors is ideal for pole grounds, transmission grounding, Telco and CATV applications where connections must be made between conductor and rods, specifically in the range of #10, #6, #4, to both 5/8 and 3/4 copper clad galvanized rods.
- Developed for applications in the power utility industry where connectors are required to withstand mid-range (20 kA symmetrical RMS) magnitudes of fault current.

BENEFITS

- ♦ Application not inhibited by disfigured ground rod end
- ♦ Taps into existing ground conductors

PRODUCT SELECTION INFORMATION: DIMENSION IN INCHES (MM)

Catalog Number	Connects Rod To	Conductor
83000-1*	5/8" Cu Clad Dia .562 (14.30)	1/0 Str.
80408-2**	5/8" Cu Clad Dia .562 (14.30)	#6 Sol. or Strd. or #4 Sol. or Strd.
80408-2**	5/8" Galv. Dia .562 (15.88)	#6 Sol. or Strd.
80408-3	3/4" Cu Clad Dia .682 (17.32)	#6 Sol. or Strd.
80408-4**	3/4" Cu Clad Dia .682 (17.32)	#4 Sol. or Strd.
80408-4**	3/4" Galv. Dia .750 (19.05)	#6 Sol. or Strd.
80408-5	3/4" Galv. Dia .750 (19.05)	#4 Sol. or Strd.
80408-6*	3/4" Cu Clad Dia .682 (17.32)	1/0 Str.
80408-7	5/8" Cu Clad Dia .562 (14.30)	#6 Sol., #8 Sol., Strd. or #10 Sol., Strd.
80408-8	5/8" Cu Clad Dia .562 (14.30)	#2 Sol, Str Cu

Technical Document
Instruction Sheet 408-9921



File No. E69905
Grounding & Bonding Including
Direct Burial.



Certified by Canadian Standards
Association.

TE Connectivity (NYSE: TEL) is a \$12 billion global technology leader. Our connectivity and sensor solutions are essential in today's increasingly connected world. We collaborate with engineers to transform their concepts into creations - redefining what's possible using intelligent, efficient and high-performing TE products and solutions proven in harsh environments. Our 75,000 people, including 7,300 design engineers, partner with customers in close to 150 countries across a wide range of industries. We believe EVERY CONNECTION COUNTS - www.TE.com.

- Mining
- Nuclear power plants
- OEM
- Petrochemical plants
- Railway
- Substations
- Transmission
- Distribution
- Windfarms
- Solar
- Hydro-electric
- Commercial/Industrial
- Telecom/Datacom
- Lightning Protection

WHEREVER ELECTRICITY FLOWS, YOU'LL FIND TE CONNECTIVITY

te.com/energy

FOR MORE INFORMATION:

TE Technical Support Centers

USA/Canada: +1 800 327 6996
Mexico: +52 0-55-1106-0800
South America: +57 1-319-8962

te.com/energy

©2017 TE Connectivity Corporation. All Rights Reserved. EPP-2951-US-7/17 E828
AMP, AMPACT, SHEAR-LOK, WRENCH-LOK, TE Connectivity and TE connectivity (logo) are trademarks. COPPERWELD is a trademark of Copperweld Bimetallics, LLC. Other logos, product and Company names mentioned herein may be trademarks of their respective owners. While TE has made every reasonable effort to ensure the accuracy of the information in this catalog, TE does not guarantee that it is error-free, nor does TE make any other representation, warranty or guarantee that the information is accurate, correct, reliable or current. TE reserves the right to make any adjustments to the information contained herein at any time without notice. TE expressly disclaims all implied warranties regarding the information contained herein, including, but not limited to, any implied warranties of merchantability or fitness for a particular purpose. The dimensions in this catalog are for reference purposes only and are subject to change without notice. Specifications are subject to change without notice. Consult TE for the latest dimensions and design specifications.