

# DIN PANEL METERS

TE'S CROMPTON INSTRUMENTS

**FEATURES**

- A range of the most popular short-scale measuring instruments in 4 case sizes
- Shock resistant sprung pivot and jewel movement
- EMC frequency meters are fully EMC and LVD compliant
- 1/4" 'fast on' terminals available

**APPLICATIONS**

- Switchgear
- Distribution systems
- Generator sets
- Control panels
- Energy management
- Utility power monitoring
- Process and motor control

**BENEFITS**

- Low cost
- Local indication
- Ease of installation
- Minimal training
- Low maintenance
- Customised options and features



A range of 48, 72, 96 and 144 mm DIN style panel meters measuring all electrical parameters and featuring moving coil or moving iron movements. All meters incorporate slide-in dials and terminal covers as standard. A range of customised options is available.

**MOVING COIL METER**

Centre cored, self shielding moving coil movement, using pivots, hairsprings and sprung jewels. Seven variations have been designed in movement ranges: all intermediate ranges are achieved by shunting the next lowest range. All DC voltmeters are 1000 ohms per volt, rectified product run at 900 ohms per volt, millivolt meters use the 5 milliamp movement.

**MOVING IRON METER**

Clapper type repulsion design using pivots, hairsprings and jewel movements. The bottom jewel is oil filled to provide damping while the top is sprung for resilience. All voltmeters are manufactured with external voltage dropper resistors to substantially reduce the self heating effects.

**APPROVALS**



**FREQUENCY METER**

100 µA 4000 Ω movement driven by an EMC hard frequency conversion circuit.

**DIALS, SCALES AND POINTERS**

Standard dials are white matt with black printed scales and bar knife-edge pointers. Black dials with white or yellow scales and pointers are also available. Interchangeable slide-in dials are used on the E242, E243, E244 and E246 90° moving iron, moving coil and frequency meter models.

General options include red supplementary pointers, red indexes (quadrant scales), red, green or blue lines, bands or segments, finely spaced divisions, multi-scales, special scales and captions to customer's requirements.

**SPECIFICATIONS**

Type of instrument	Moving iron for current and voltage	Moving coil for current and voltage	Moving coil with rectifiers for current and voltage	Moving coil with built-in transducer for frequency measurement	Maximum demand indicators	Combined MD with moving iron movement
Format	48 x 48 mm 72 x 72 mm 96 x 96 mm 144 x 144 mm	48 x 48 mm 72 x 72 mm 96 x 96 mm 144 x 144 mm	48 x 48 mm 72 x 72 mm 96 x 96 mm 144 x 144 mm	72 x 72 mm 96 x 96 mm 144 x 144 mm	72 x 72 mm 96 x 96 mm	96 x 96 mm
Movement type	Sprung pivot jewel with silicon oil damping	Sprung pivot jewel with eddy current damping	Sprung pivot jewel with eddy current damping	Sprung pivot jewel with eddy current damping	Sprung pivot jewel with silicon oil damping	Sprung pivot jewel with silicon oil damping
Burden	0.5 VA-15 A then 0.8 VA voltmeters 4.5 VA	See type specific specifications	See type specific specifications	See type specific specifications	2.5 VA	3 VA
Accuracy	1.5% to DIN43780	1.5% to DIN43780	2.5% to DIN43780	0.5% to DIN43780	3%	3% on MDI 1.5% ammeter
Input type	AC current or voltage	DC current or voltage	AC current or voltage	AC voltage	AC current	AC current
Measuring range	6-600 V 100 mA-100 A 48 mm only up to 40 A	50 mV-600 V 100 µA-40 A, 48 mm only 25 A	15-600 V 1m A-100 mA and 1 A & 5 A	57.7 V @ 45 Hz 500 V @ 44 Hz	0-1/1.2 A or 0-5/6 A 8, 15 or 20 minute delays	1-6 A 8, 15 or 20 minute delays 0-5 A/6 A instantaneous
Dielectric voltage withstand test	3 kV AC	3 kV AC	3 kV AC	3 kV AC	3 kV AC	3 kV AC

**DIN16257 SYMBOL MEANING FOR CALIBRATION POSITION**

**VERTICAL**



**HORIZONTAL**



**INCLINED**

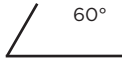

Inclination of dial surface. Required orientation must always be stated when ordering if other than vertical mounting is required.

GENERAL SPECIFICATIONS	
Performance	BS EN60051
Measuring ranges	DIN43701
Accuracy overload	BS EN60051
Dimensions	DIN43700
Scale marking generally to	DIN43802
Magnetic influence	BS EN60051
Safety	BS EN61010-1
Terminals	Clamp strap M4 for up to 25 A. Clamp strap M8 for over 25 A 1/4" spade terminals available for models E243 and E244
Humidity range	Up to 95% RH (non condensing)
Test voltage @50Hz	3 kV RMS for 1 minute
Ammeter ranges	1.0/1.2/1.5/2.5/5/6 and decade multiples thereof
Overload AC current	x 1.2 continuous x 10 for 5 seconds
AC voltage and frequency	x 1.2 continuous x 2 for 5 seconds
Standard calibration	23°C. Calibration at other temperatures available on request
Operating temperature	-20°C to +60°C
Damping time	Less than 3 seconds
Enclosure code	IP52 as standard IP54 on request
Case and base	Grade UL94V0
Case	Dimensions and panel cut out conform to IEC473, DIN43700. Case made from glass filled polycarbonate self-extinguishing and non drip in accordance with UL94V-O
Bezel	Slim-line DIN43802, black as standard
Bezel window	Standard sheet glass, with zero adjusters where appropriate. Non reflecting glass or polycarbonate shatterproof windows are available
Installation	Installations in switchboard panel or mosaic arrangement on equipment or machine with a panel thickness of up to 40 mm in a horizontal or vertical plane
Fixing on panel	Swivel captive fasteners, which can be fixed at either corner
Mounting position	Normal vertical mounting or as indicated on the scale in accordance with DIN16257. A deviation of ±15° is permissible
Insulation group	Insulation resistance more than 5Ω@ 500 V
Environmental	Measurement category III IEC 1010-1 Pollution degree 2 IEC 1010-1 Electrical rating 600 V RMS (920 V peak)
Approvals	EMC, LVD, Lloyds and UL

DIMENSIONS			
Moving coil measuring range		Moving iron measuring range	
6 - 60 A	C=67 mm	0 - 30 A	C=64 mm
>60 A	C=78 mm	>30 A	C=67 mm

MAX. PANEL THICKNESS = 40 MM		
D	A	B
48 x 48	45 x 45	4
72 x 72	68 x 68	4
96 x 96	92 x 92	4
144 x 144	138 x 138	4

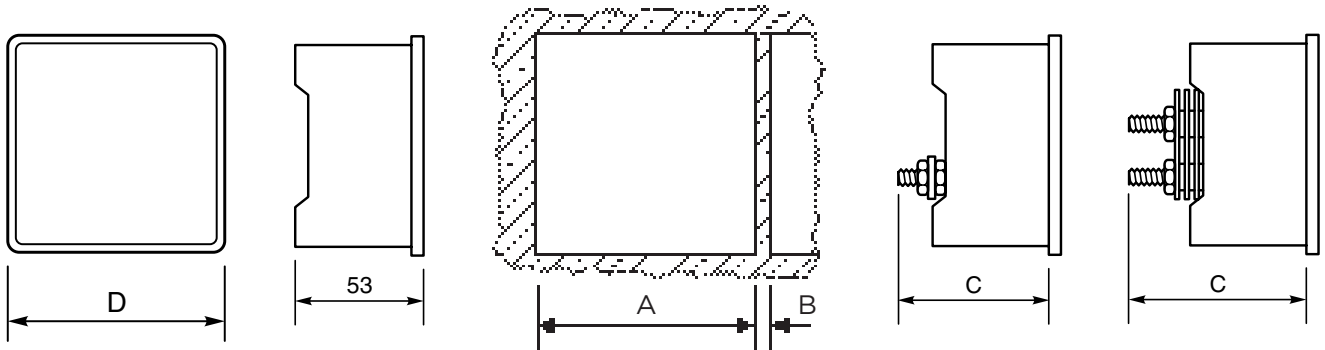

## Short scale moving iron AC ammeters and voltmeters

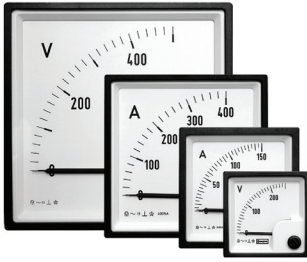

Designed to measure AC current or voltage, these meters indicate true RMS values and are substantially independent of system waveform. Scales are calibrated down to 20%, and ammeters can have overload scales of x2, x3, x5 or x6 for motor start duty. Ammeters can be supplied for use with -/1 A or -/5 A current transformers, whilst voltmeters can be scaled for use with voltage transformers. Meters can be used to measure DC at reduced accuracy.

### PRODUCT CODES

PRODUCT CODES				
Bezel size mm	48	72	96	144
Scale length mm	42	65	94	145
AC ammeter	E242-75A	E243-02A	E244-02A	E246-02A
x2 overload ammeter	E242-752A	E243-022A	E244-022A	-
x3 overload ammeter	E242-753A	E243-023A	E244-023A	-
x5 overload ammeter	E242-755A	E243-025A	E244-025A	-
x6 overload ammeter	E242-756A	E243-026A	E244-026A	-
AC voltmeter	E242-75V	E243-02V	E244-02V	E246-02V

### SPECIFICATIONS

Accuracy	Class 1.5
Frequency	50, 60 Hz, (400 Hz on request)
Burden at 50 Hz	Ammeters: 0.5 VA Voltmeters: Up to 4.5 VA maximum
Ratings	Ammeters: 0.5-100 A AC direct connected (40 A for E242-75 A and E246-02 A) Maximum system voltage 600 V AC Low load/high middle, maximum 10 A
Voltmeters	6-600 V

### CONNECTIONS

#### AC AMMETER

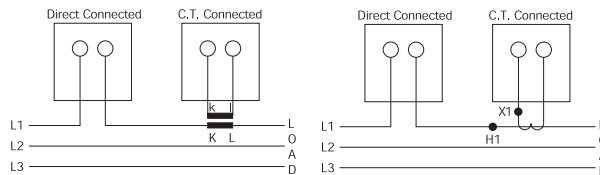

#### AC VOLTMETER

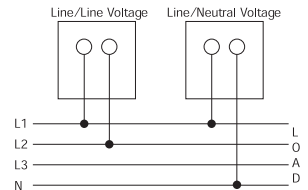

## Frequency meters

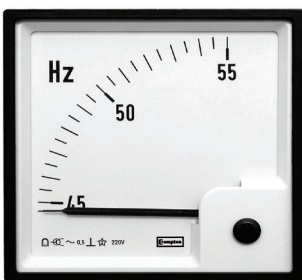

Frequency meters use an integral electronic converter and a moving coil indicator. These easy to read meters have accuracy Class 0.5.

### PRODUCT CODES

PRODUCT CODES			
Bezel size mm	48	72	96
Scale length mm	42	65	94
Product codes	E242-41S	E243-41S	E244-41S

### SPECIFICATIONS

Ratings	100 - 125 V AC 200 - 250 V AC 380 - 440 V AC* 500 V AC* *Use E242-89A and 253-THZ in place of E242-41S for voltages over 380 V Models available for use with VTs
Frequency	0.5%: 45/55 Hz, 55/65 Hz, 45/65 Hz, 360/440 Hz
Burden	4 VA maximum

### CONNECTIONS

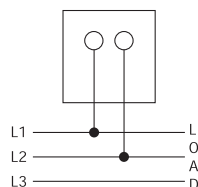

## Short scale maximum demand indicators

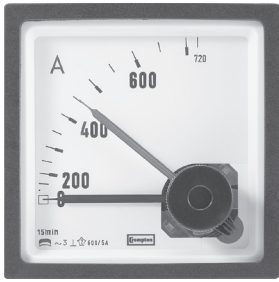

The thermal/time characteristics of MDI meters monitor the most economic use of cable, fusegear and transformers. The directly heated bimetal element indicates mean RMS current over 8, 15, or 20 minutes, and a red slave pointer shows the highest value reached. The reset knob is wire sealable. Scales are calibrated to match the CT primary plus 20% overload. End values are selected from: 1.2, 1.8, 2.4, 3, 3.6, 4.8, 6, 7.2, 9 amps and their multiples of 10 and 100.

PRODUCT CODES		
Bezel size mm	72	96
Scale length mm*	65	94
PRODUCT CODES		
<b>8 minute time lag</b>		
without limiting CT for use with 5 A CT	E243-16B	E244-16B
<b>15 minute time lag</b>		
without limiting CT for use with 5 A CT	E243-16A	E244-16A
<b>20 minute time lag</b>		
without limiting CT for use with 5 A CT	E243-16J	E244-16J

\* Scaled 0/100/120% of CT primary value.

SPECIFICATIONS	
Accuracy	Class 3
Options	5 A for use with separate CT 5/5 A saturating CT 1/5 A saturating CT
Burden at 50 Hz	MDI - 2.5 VA, CT - 2 VA
Overload withstand	Standard: 5 x FL for 5 seconds, 10 x FL for 1 second. With saturating CT: 10 x FL for 3 seconds, 20 x FL for 1 second
Frequency	50/60 Hz

## CONNECTIONS

Maximum demand indicators

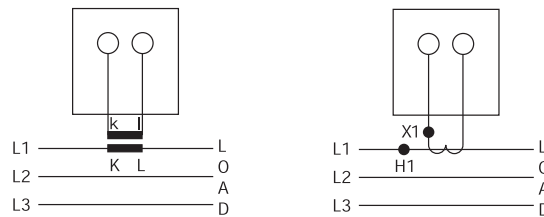

## Combined AC ammeter and maximum demand indicators



Where measurement of instantaneous and maximum demand currents are required, these instruments combine both movements in one case. The meter can also replace an existing AC ammeter. Meets the same specifications listed above.

PRODUCT CODES		
Bezel size mm	72	96
Scale length mm*	65	94
PRODUCT CODES		
<b>8 minute time lag</b>		
without limiting CT for use with 5 A CT 3 VA	-	E244-16Q
<b>15 minute time lag</b>		
without limiting CT for use with 5 A CT 3 VA	E243-16C	E244-16C
<b>20 minute time lag</b>		
without limiting CT for use with 5 A CT 3 VA	-	E244-16H

\* Scaled 0/100/120% of CT primary value.

SPECIFICATIONS	
Accuracy	Moving iron ammeter: Class 1.5 MDI: Class 3
Burden at 50 Hz	MI - 0.5 VA, MDI - 2.5 VA saturating CT - 2 VA

## Short scale moving coil DC meters

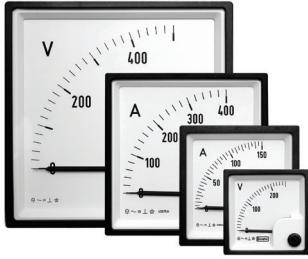

Moving coil meters are suitable for all DC systems. The linear scale is calibrated down to zero and the accuracy maintained down to 10%. High currents are measured with separate shunts and suitably scaled indicators. Suppressed, centre and offset zero models are available.

PRODUCT CODES				
Bezel size mm	48	72	96	144
Scale length mm	42	65	94	145
PRODUCT CODES				
Ammeters	E242-89A	E243-01A	E244-01A	E246-01A
Ammeters suppressed zero	E242-89R	E243-01R	E244-01R	E246-01R
Ammeters centre zero	E242-89C	E243-01C	E244-01C	E246-01C
Voltmeters	E242-89V	E243-01V	E244-01V	E246-01V
Voltmeters suppressed zero	E242-89S	E243-01S	E244-01S	E246-01S
Voltmeters centre zero	E242-89N	E243-01N	E244-01N	E246-01N

SPECIFICATIONS	
Accuracy	Class 1.5
Ratings	Ammeters: 100 $\mu$ A-25 A 4/20 mA suppressed zero 40 A for model E242, E243 and E244 up to 100 A Voltmeters: 50 mV-600 V 1/5 V suppressed zero 50, 60, 75, 100, 150 mV for use with shunts
Impedance	Ammeters: 75 mV internal shunt above 60mA Voltmeters: 1000 $\Omega$ /V above 1 V

### CONNECTIONS

#### DC VOLTMETER

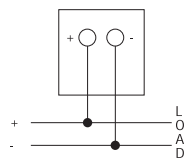

#### DC AMMETER

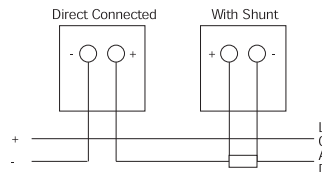

## Short scale rectified AC ammeters and voltmeters



For high frequency or linear full scale AC measurements, these instruments measure average values of sinusoidal waveforms and are scaled in RMS values.

The high quality silicon bridge rectifier gives a linear scale down to near zero, where some compression occurs.

PRODUCT CODES				
Bezel size mm	48	72	96	144
Scale length mm	42	65	94	145
PRODUCT CODES				
Ammeters	E242-89B	E243-01B	E244-01B	E246-01B
Voltmeters	E242-89W	E243-01W	E244-01W	E246-01W

SPECIFICATIONS	
Accuracy	1.5% ES
Ratings	Ammeters: 250 $\mu$ A-1 A AC Over 1 A via CTs
Voltmeters	15 - 600 V AC direct connected. Models available for use with VTs
Frequency	50/60 Hz, (Single frequencies 25 Hz - 1 kHz on request)

### CONNECTIONS

#### AC AMMETER

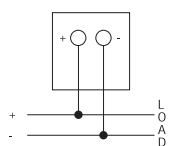

#### AC VOLTMETER

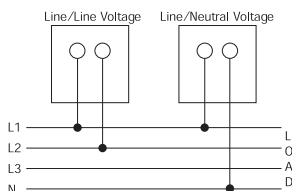

## Short scale process indicators



Meters are used to check process functions locally or remotely at centralised controls.

These moving coil instruments offer a wide variety of electrical and mechanical readouts and are operated by transducer, tachogenerator, thermocouple, resistance bulb or other DC analogue signals. Suppressed, centre and offset zero models are available on request.

PRODUCT CODES				
Bezel size mm	48	72	96	144
Scale length mm	42	65	94	145
PRODUCT CODES				
AC current	E242-89A	E243-01A	E244-01A	E246-01A
AC voltage	E242-89V	E243-01V	E244-01V	E246-0 V
Phase angle	-	E243-014	E244-014	-
Watts	-	E243-015	E244-015	-
VAR	-	E243-016	E244-016	-
VA	-	E243-017	E244-017	-

SPECIFICATIONS	
Accuracy	Class 1.5
Ratings	1, 2, 5, 10, 20 mA 4/20 mA suppressed zero

### CONNECTIONS

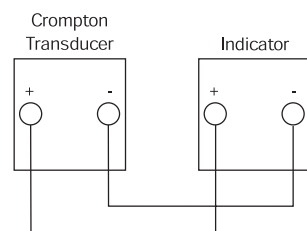

**FEATURES**

- Integral selector switch
- True RMS measurement
- Scaled for customer VT or CT primary values
- DIN 72 and DIN 96 models
- Terminal cover as standard
- Shock resistant sprung pivot and jewel movement
- x2 overload ammeters

**APPLICATIONS**

- Switchgear
- Distribution systems
- Generator sets
- Control panels
- Energy management
- Building management

**BENEFITS**

- Space and time saving
- Competitive cost
- Local indication
- Ease of installation
- Low maintenance
- Customised options and features



These 96 mm and 72 mm units offer Class 1.5 true RMS measurement of three-phase AC voltage or current with various switch notation options. The integral selector switch eliminates the necessity for a separate selector switch, saving valuable panel space and providing installation benefits. These robust moving iron meters incorporate a clapper type repulsion design which utilises a pivot, hairspring and jewel movement. The bottom jewel is oil filled to provide damping while the top is sprung for resilience. Voltmeters are manufactured with internal voltage dropper resistors.

**APPROVALS**

- IEC61010-1B2001, EMC and LVD



PRODUCT CODES - AC AMMETERS WITH SELECTOR SWITCH			
Code	Case size	Full scale deflection	Switch notation
E243-02E-G-LS**-C7-AMP3	72 mm	0/5 A AC	OFF L1 L2 L3
E244-02E-G-LS**-C7-AMP3	96 mm	0/5 A AC	OFF L1 L2 L3
E243-022E-G-LS**-C7-AMP3	72 mm	0/5/10 A AC	OFF L1 L2 L3
E244-022E-G-LS**-C7-AMP3	96 mm	0/5/10 A AC	OFF L1 L2 L3
E243-02E-G-LA**-C7-AMP3	72 mm	0/1 A AC	OFF L1 L2 L3
E244-02E-G-LA**-C7-AMP3	96 mm	0/1 A AC	OFF L1 L2 L3
E243-022E-G-LA**-C7-AMP3	72 mm	0/1/2 A AC	OFF L1 L2 L3
E244-022E-G-LA**-C7-AMP3	96 mm	0/1/2 A AC	OFF L1 L2 L3

\*\*Insert applicable CT primary value.

PRODUCT CODES - AC VOLTMETERS WITH SELECTOR SWITCH				
Code	Case size	Full scale deflection	Switch notation	3-phase
E243-02Q-G-PM**-C7-SW6	72 mm	0/120 V AC	OFF L1L2 L2L3 L3L1	3W
E243-02Q-G-PZ**-C7-SW6	72 mm	0/150 V AC	OFF L1L2 L2L3 L3L1	3W
E243-02Q-G-PZ-PZ-C7-SW6	72 mm	0/150 V AC	OFF L1L2 L2L3 L3L1	3W
E243-02Q-G-RX-RX-C7-SW6	72 mm	0/300 V AC	OFF L1L2 L2L3 L3L1	3W
E243-02Q-G-SF-SF-C7-SW3	72 mm	0/500 V AC	L1L3 L1L2 L2L3 L3N L2N L1N	4W
E243-02Q-G-SJ-SJ-C7-SW3	72 mm	0/600 V AC	L1L3 L1L2 L2L3 L3N L2N L1N	4W
E244-02Q-G-PZ**-C7-SW6	96 mm	0/150 V AC	OFF L1L2 L2L3 L3L1	3W
E244-02Q-G-PZ-PZ-C7-SW6	96 mm	0/150 V AC	OFF L1L2 L2L3 L3L1	3W
E244-02Q-G-RX-RX-C7-SW6	96 mm	0/300 V AC	OFF L1L2 L2L3 L3L1	3W
E244-02Q-G-SF-SF-C7-SW3	96 mm	0/500 V AC	L1L3 L1L2 L2L3 L3N L2N L1N	4W
E244-02Q-G-SF-SF-C7-SW3	96 mm	0/600 V AC	L1L3 L1L2 L2L3 L3N L2N L1N	4W

\*\*Insert applicable VT primary and secondary value, e.g. 15 kV/110 V.

PRODUCT CODES - OPTIONS
Description
Non reflecting glass window
Red supplementary pointer, externally adjustable
Red index mark (triangle)

Please state any required options at time of ordering.



CONNECTIONS

AC AMMETER WITH SELECTOR SWITCH

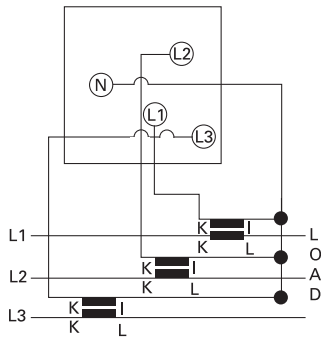

AC VOLTMETERS 3-PHASE 3-WIRE

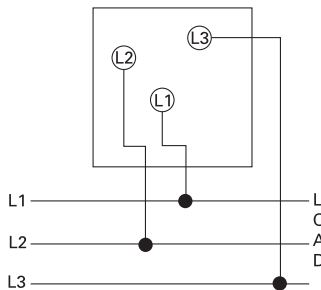

AC VOLTMETERS 3-PHASE 4-WIRE

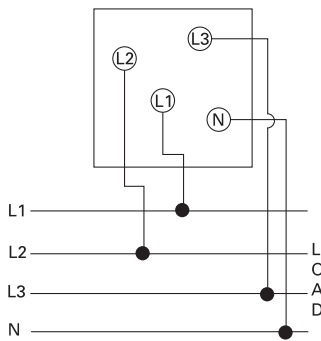

GENERAL SPECIFICATIONS

<b>Accuracy</b>	1.5% of full scale deflection (FSD)
<b>Input rating</b>	Ammeter: 1 A, 5 A 1/2 A or 5/10 A moving iron, direct connected Voltmeter: 120, 300, 500 and 600 V AC
<b>Frequency</b>	50, 60 Hz (400 Hz on request)
<b>Burden at 50 Hz</b>	Ammeters: 0.5 VA Voltmeters: 4-5 VA max
<b>Overload ammeter</b>	2 x I <sub>n</sub> continuous for 2 minutes, 4 x I <sub>n</sub> for 1 minute
<b>Overload voltmeter</b>	1.2 x continuous 2 x for 5 seconds
<b>Movement</b>	Moving iron shock resistant sprung pivot and jewel
<b>Scale length</b>	DIN72: 54 mm DIN96: 97 mm
<b>Enclosure style</b>	Panel mount to DIN42700
<b>Enclosure material</b>	Grade UL94 VO
<b>Bezel style</b>	Black matt DIN43802
<b>Window</b>	Standard sheet glass
<b>Terminals</b>	M4 captive screw clamp
<b>Fixing</b>	2 corner fixing clamps with tensioning thumb screws
<b>Mounting position</b>	Vertical mount to DIN16257, inclination of dial surface ±15%
<b>Damping time</b>	Less than 3 seconds
<b>Compliant with</b>	IEC61010-1B2001, CAT III 600V, EMC and LVD
<b>Operating temperature</b>	-20°C to +55°C
<b>Storage temperature</b>	-40°C to +75°C
<b>Calibration temperature</b>	23°C
<b>Relative humidity</b>	95% (non condensing)
<b>Dimensions</b>	96DIN: 96 mm high x 96 mm wide x 63 mm deep 72DIN: 72 mm high x 72 mm wide x 63 mm deep
<b>Panel cut out</b>	DIN96: 92 mm x 92 mm DIN72: 68 mm x 68 mm
<b>IP protection</b>	IP40
<b>Weight</b>	E243-02E 275 g E243-02Q 300 g E244-02E 360 g E244-02Q 390 g

DIMENSIONS

72DIN models

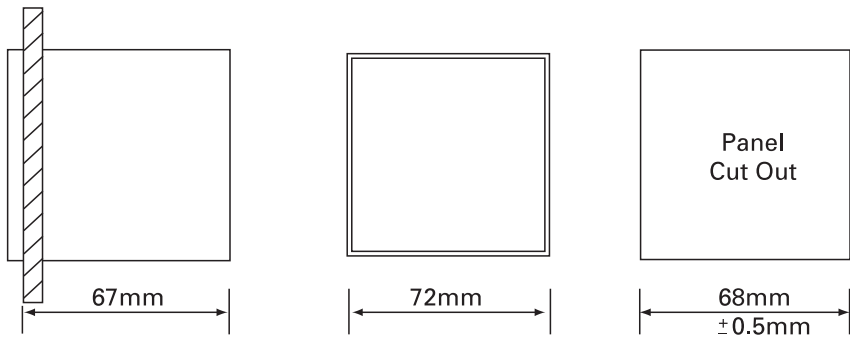

96DIN models

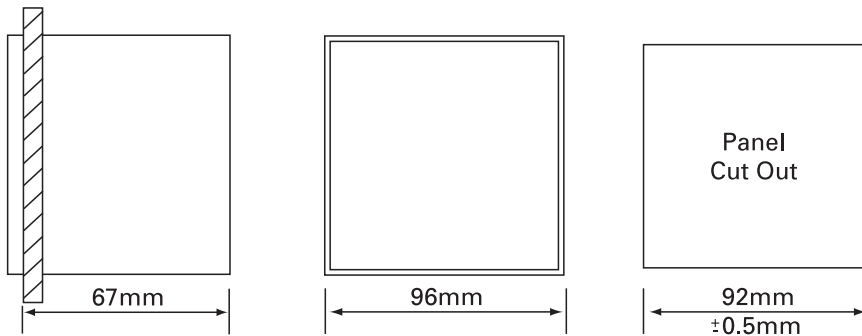

**FEATURES**

- DIN 48, 72 and 96mm case style
- Slide in dials
- Moving coil movement
- Terminal covers
- Resistance to mechanical impact and vibrations

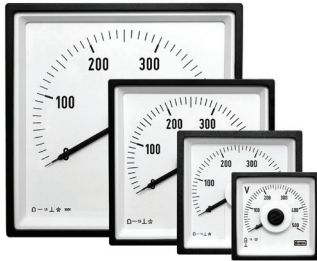

**APPROVALS**

- BV approved



**APPLICATIONS**

- Switchgear
- Distribution systems
- Generator sets
- Control panels
- Energy management
- Building management
- Utility power monitoring
- Process control
- Motor control

**BENEFITS**

- Local indication
- Ease of installation
- Minimal training
- Low maintenance
- Customised options and features

**MOVING COIL METER**

Centre cored, self shielding moving coil movement, made of light quality material which is not sensitive to external electromagnetic fields and is resistant to mechanical impacts and vibrations.

**FREQUENCY METER**

Meter uses a 100 microamps 4000 ohm movement driven by an EMC hard frequency conversion circuit.

**DIALS, SCALES AND POINTERS**

Standard dials are white matt with black printed scales and bar knife-edge pointers. Black dials with white or yellow scales and pointers are also available.

Standard options include red supplementary pointers, and non-reflecting glass. Other options available on request.

GENERAL SPECIFICATIONS	
<b>Performance</b>	BS EN60051 11/2 % of full scale deflection (FSD)
<b>Measuring ranges</b>	DIN43701
<b>Accuracy overload</b>	BS EN60051
<b>Dimensions</b>	DIN43700 see detail on following page
<b>Scale marking generally to</b>	DIN43802
<b>Magnetic influence</b>	BS EN60051
<b>Safety</b>	BS EN61010-1
<b>Terminals</b>	Clamp strap M4 for up to 15 A. Clamp strap M6 for 15 to 40 A.
<b>Humidity range</b>	Up to 75% RH (non condensing)
<b>Test voltage @50Hz</b>	2 kV RMS for 1 minute
<b>Overload AC current</b>	x 1.2 continuous, or x 10 for 5 seconds max
<b>AC voltage and frequency</b>	x 1.2 continuous, or x 2 for 5 seconds max
<b>Standard calibration</b>	23°C. Calibration at other temperatures available on request
<b>Operating temperature</b>	-10°C to +55°C
<b>Damping time</b>	Less than 3 seconds
<b>Enclosure code</b>	IP52 as standard IP54 on request
<b>Case and base</b>	Grade UL94V0
<b>Case</b>	Dimensions and panel cut out conform to IEC473, DIN43700. Case made from glass filled polycarbonate self-extinguishing and non drip in accordance with UL94V-O
<b>Bezel</b>	Slim-line DIN43802, black as standard
<b>Bezel window</b>	Standard sheet glass, with zero adjusters where appropriate. Non reflecting glass and polycarbonate windows are available
<b>Installation</b>	Installations in switchboard panel or mosaic arrangement on equipment or machine with a panel thickness of up to 40 mm in a horizontal or vertical plane
<b>Fixing on panel</b>	2 captive fasteners (optional 4 on request)
<b>Mounting position</b>	Normal vertical mounting or as indicated on the scale in accordance with DIN16257. A deviation of ±15° is permissible
<b>Insulation group</b>	Insulation resistance more than 5 MΩ@ 500 V
<b>Environmental</b>	Measurement category III IEC 1010-1 Pollution degree 2 IEC 1010-1 Electrical rating 600 V RMS (920 V peak)
<b>Approvals</b>	EMC and LVD, BV Approval

DIN16257 SYMBOL MEANING FOR CALIBRATION POSITION

VERTICAL



HORIZONTAL



INCLINED

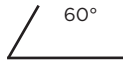

Inclination of dial surface.

Required orientation must always be stated when ordering if other than vertical mounting is required.

PRODUCT DIMENSIONS

Description		M242-01*, M242-02*, M242-05*	M243-01*, M243-02*, M243-05*	M244-01*, M244-02*, M244-05*, M244-41R*, M244-41E*, M244-41L*, M244-41D*, M244-80*	M246-01*, M246-02*, M246-05*
Bezel (mm)	a	48	72	96	144
Panel cut out (mm)	b	45 (+0.6)	68 (+0.8)	92 (+0.8)	138 (+1.0)
Bezel height (mm)	c	5.0	5.5	5.5	8.0
Terminal cover (mm)	d	42.5	66.5	90	90

DIMENSIONS

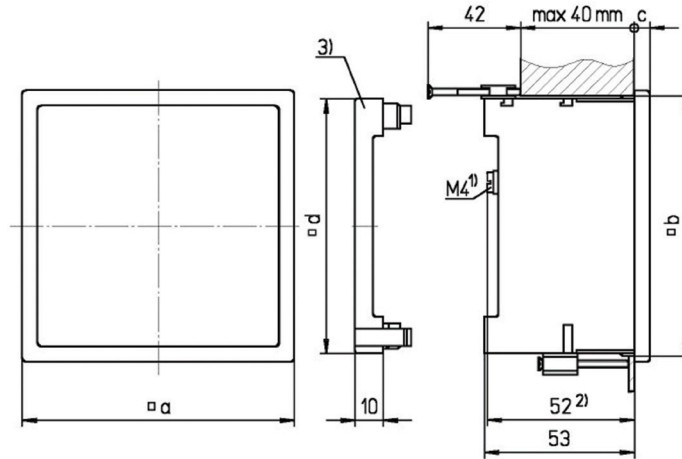

M242-01\*, M242-02\*, M242-05\*, M243-01\*, M243-02\*, M243-05\*,  
M244-01\*, M244-02\*, M244-41R\*, M244-41E\*. M244-05\*, M246-01\*,  
M246-02\*, M246\*-05\*

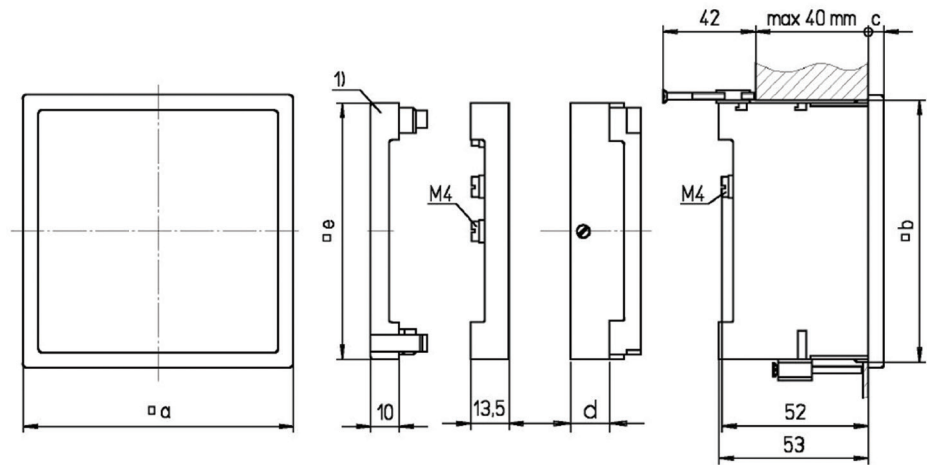

M244-41L\*, M244-41D\*, M244-41S\*,  
M244-80\* (d = 27.3 mm)

**FEATURES**

- Measures AC current or voltage
- CT connected ammeters
- Direct and VT connected voltmeters
- Linear scaling
- 240° long scale version
- x6 overload



**CONSTRUCTION**

- Mean value measurement of current or voltage
- Containing germanium diodes of low reverse current
- Slot in screw fixing

**APPROVALS**

- CE marked



**APPLICATIONS**

- AC switchgears, panels and distribution boards

**BENEFITS**

- Easy to operate
- Exchangeable dial
- Low consumption
- Terminal cover included

**SPECIFICATION**

Accuracy class	1.5
Maximum continuous overload	1.2 x In, 1.2 x Un
Maximum short duration overload	10xIn - 9x0.5s+1x5s/60s - 2xUn - 9x0.5s+1x5s/60s
Frequency	50/60 Hz

**PRODUCT CODES**

Bezel size (mm)	48	72	96	144
Scale length (mm)	71	113	155	235
AC ammeter rectified 240°	M242-05B	M243-05B	M244-05B	M246-05B
AC voltmeter rectified 240°	M242-05W	M243-05W	M244-05W	M246-05W
AC ammeter rectified 240° x6 overload		M243-056B	M244-056B	

**Standard input ranges**

AC ammeter rectified 240° scaling (0/x A) meter (0/x A), (0/ x A x6), 1, 5A M243, M244	1, 5 A (M242-05B delivered with separated current transformer)
AC voltmeter rectified 240° scaling (0/x V)	20, 15, 20, 30, 60, 100, 150, 250, 300 (limit at M242). 400, 500, 600 V
AC voltmeter for VT connection (0/x V)	120 V (for use with VT's x/100 V), 132 V (for use with VT's x/110 V), 144 V (for use with VT's 120 V), 125 V, 137,5 V, 150 V (for use with some VT's having primary voltage less then 1 kV)

**CONNECTION DIAGRAMS**

AC AMMETER

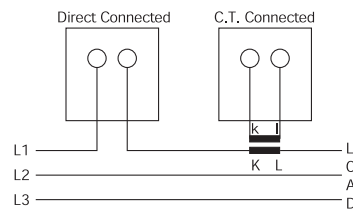

AC VOLTMETER

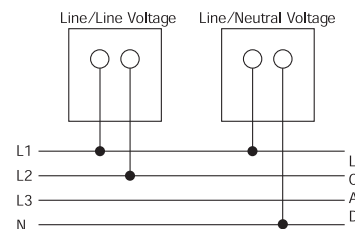

**ORDER DATA/EXAMPLES**

AMMETER

- 1) Select type: M243-05B,
- 2) Specify input: 0-1 A,
- 3) Specify scaling: 0-1 kA,
- 4) Specify frequency: 50/60 Hz

VOLTMETER

- 1) Select type: M244-05 W,
- 2) Specify input: 0-500 V,
- 3) Specify scaling: 0-500 V,
- 4) Specify frequency: 50/60 Hz

VOLTMETER, VT CONNECTED

- 1) Select type: M244-05 W,
- 2) Specify input: 0-120 V,
- 3) Specify scaling: 0-12 kV,
- 4) Specify frequency: 50/60 Hz,
- 5) Specify VT ratio: 10/0.1 kV

**FEATURES**

- Measures DC current or voltage
- Direct and shunt connected ammeters
- Direct connected voltmeters
- Live zero ammeters and voltmeters
- Centre zero ammeters and voltmeters
- Linear scaling
- 240° long scale version

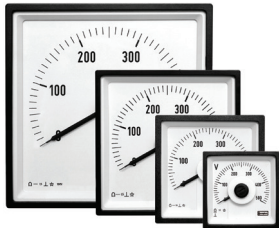

**APPLICATIONS**

- DC switchgears, panels and distribution boards
- Control boards
- Process indication
- Battery supervision

**BENEFITS**

- Easy to operate
- Exchangeable dial
- Terminal cover included

**SPECIFICATION**

Accuracy class	1.5
Maximum continuous overload	1.2 x In, 1.2 x Un
Maximum short duration overload	10xIn - 9x0.5s+1x5s/60s, 2xUn - 9x0.5s+1x5s/60s

**PRODUCT CODES**

Bezel size (mm)	48	72	96	144
Scale length (mm)	71	113	155	235
DC ammeter 240°	M242-05A	M243-05A	M244-05A	M246-05A
DC voltmeter 240°	M242-05V	M243-05V	M244-05V	M246-05V
DC ammeter 240° live zero	M242-05R	M243-05R	M244-05R	M246-05R
DC voltmeter 240° live zero	M242-05S	M243-05S	M244-05S	M246-05S
DC ammeter 240° centre zero	M242-05C	M243-05C	M244-05C	M246-05C
DC voltmeter 240° centre zero	M242-05N	M243-05N	M244-05N	M246-05N

**Standard input ranges**

DC ammeter 240° scaling (0/x A)	1, 1.5, 2.5, 4, 5, 6, 10, 15, 20, 25 (limit on M242), 30, 40, 50, 60 A
DC ammeter 240° scaling, process and shunt indicators	0-1, 0-5, 0-10, 0-20, 4-20 mA, 0-50, 0-60, 0-75 mV
DC ammeter 240° scaling, centre zero (x-0-x A)	1-0-1, 1.5-0-1.5, 2.5-0-2.5, 4-0-4, 5-0-5, 6-0-6, 10-0-10 (limit on M242), 15-0-15, 20-0-20, 25-0-25, 30-0-30A
DC ammeter 240° scaling, centre zero process and shunt indicators	1-0-1, 5-0-5, 10-0-10, 20-0-20 mA, 50-0-50, 60-0-60, 75-0-75 mV
DC voltmeter 240° scaling (0/x V)	10, 15, 20, 30, 60, 100, 150, 250, 300 (limit on M242). 400, 500, 600 V
DC voltmeter 240° scaling, process indicators	1-5, 2-10 V
DC voltmeter 240° scaling, centre zero (x-0-x V)	10-0-10, 15-0-15, 20-0-20, 30-0-30, 60-0-60, 100-0-100, 150-0-150 (limit on M242) 250-0-250, 300-0-300 V

**CONSTRUCTION**

- Magnet core none sensitive to external fields
- Slot in screw fixing

**APPROVALS**

- CE marked



**CONNECTION DIAGRAMS**

DC VOLTMETER

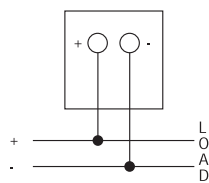

DC AMMETER

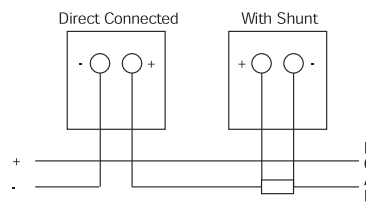

TRANSDUCER INDICATOR

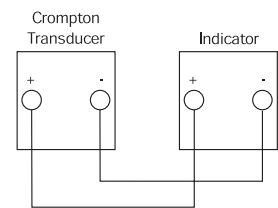

**ORDER DATA/EXAMPLES**

AMMETER  
EXAMPLE A

- 1) Select type: M243-05 A,
- 2) Specify input: 0-10 A,
- 3) Specify scaling: 0-10 A

EXAMPLE B

- 1) Select type: M244-05R,
- 2) Specify input: 4-20 mA,
- 3) Specify scaling: 0-100 MVA

EXAMPLE C

- 1) Select type: M244-05C,
- 2) Specify input: 60-0-60 mV,
- 3) Specify scaling: 150-0-150 A

VOLTMETER  
EXAMPLE A

- 1) Select type: M244-05 V,
- 2) Specify input: 0-15 V,
- 3) Specify scaling: 0-15 V

EXAMPLE B

- 1) Select type: M244-05S,
- 2) Specify input: 2-10 V,
- 3) Specify scaling: 0-100 %

EXAMPLE C

- 1) Select type: M242-05N,
- 2) Specify input: 10-0-10 V,
- 3) Specify scaling: 2 0-0-20 A

**FEATURES**

- Measures AC frequencies
- Pointer type available as 240° long scale version
- Reed type available with
  - 13 reeds (47-53 Hz, 57-63 Hz)
  - 21 reeds (45-55 Hz, 55-65 Hz)
- Direct or VT connected

**APPLICATIONS**

- AC switchgears, panels and distribution boards
- Control board
- Generator sets

**BENEFITS**

- Easy to operate
- High visibility
- Terminal cover included
- Marine approved

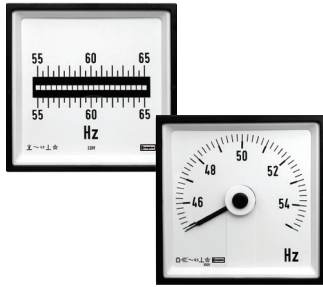

SPECIFICATION	
Accuracy class	0.5 - 1.2 x Un continuously
Overload	1.5 x Un for 2 hours (pointer type only) - 2 x Un for 5 seconds - 1 VA at nominal voltage 57-110 V and 230 V
Burden pointer type	1.7 VA at nominal voltage 400V - 2VA at nominal voltage 500 V
Burden reed type	0.7 ... 1.2 VA at nominal voltage 110-230 V - 1.4 ... 2 VA at all other nominal voltages

PRODUCT CODES				
Bezel size (mm)	96	96	96	96
Scale length (mm)	95	135	-	-
Frequency meter 240°	-	M244-41L	-	-
Frequency meter 13 reeds	-	-	M244-41R	-
Frequency meter 21 reeds	-	-	-	M244-41R
Standard input ranges				
Pointer type	57-110 V, 400V +/- 20%, 500V +/-20%			
Reed type	100V, 110V, 230V, 400V +/- 20%, 500V +/-20%			
Scaling				
13 reeds on reed type meters with scaling	47-50-53 Hz, 57-60-63 Hz			
21 reeds on reed type meters with scaling	45-50-55 Hz, 55-60-65 Hz			
Scaling 240° pointer types	45-50-55 Hz, 55-60-55 Hz, 45-55-65 Hz			

**CONSTRUCTION**

- Pointer type contains internal transducer, powered from input voltage and moving coil meter
- Reed type uses steel reeds in an electromagnetic field. Reeds are calibrated to its individual frequency to vibrate in resonance with the electromagnet and vibrates at full amplitude

**APPROVALS**

- CE marked
- BV approved



**CONNECTION DIAGRAMS**

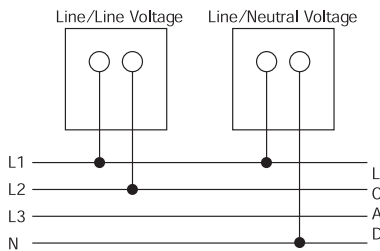

**ORDER DATA/EXAMPLES**

POINTER TYPE 240°

- 1) Select type: M244-41L,
- 2) Specify input voltage: 57-110 V,
- 3) Specify frequency: 45/65 Hz,
- 4) Specify scaling: 45-55-65 Hz

REED TYPE 13 REEDS

- 1) Select type: M244-41R,
- 2) Specify input voltage: 230 V,
- 3) Specify frequency: 47/53 Hz,
- 4) Specify scaling: 47-50-53 Hz

REED TYPE 21 REEDS

- 1) Select type: M244-41R,
- 2) Specify input voltage: 110 V,
- 3) Specify frequency: 55/65 Hz,
- 4) Specify scaling: 55-60-65 Hz

## Elapsed time meters (hours run meters)



Elapsed time meters (ETM) or hours-run meters monitor “ON/RUN” time of plant and equipment, allowing the user to effectively control production efficiency, cost estimation and service period monitoring for preventative maintenance. Time is measured in increments of 0.01h up to 99999.99 hours after which the meter automatically resets to zero. Meters are non-resettable before this time to prevent accidental resetting.

SPECIFICATION	
<b>AC</b>	
Display	99999.99
Voltage	100-125 V AC 200-250 V AC 380-440 V AC
Frequency	50 or 60 Hz
Operating temperature	-25°C to +80°C
IP Protection	IP52
Burden	1 VA (100-125 V AC) 2 VA (200-250 V AC) 3.5 VA (380-440 V AC)
<b>DC</b>	
Display	99999.99
Voltage	12-36 V DC 10-80 V DC 110 V DC
Operating temperature	-20°C to +70°C
IP Protection	IP52
Burden	0.5 VA (12 - 36 V AC) 1 VA (10-80 V AC) 1.5 VA (110 V AC) 0.5 VA (6 - 30 V) 1 VA (36 - 80 V)

BEZEL SIZE PRODUCT CODES	48 MM	72 MM	96 MM
100-125 V AC 50 Hz	M242-155-G-PL-ZH-C5	M243-155-G-PL-ZH-C5	M244-155-G-PL-ZH-C5
200-250 V AC 50 Hz	M242-155-G-RN-ZH-C5	M243-155-G-RN-ZH-C5	M244-155-G-RN-ZH-C5
380-440 V AC 50 Hz	M242-155-G-RY-ZH-C5	M243-155-G-RY-ZH-C5	M244-155-G-RY-ZH-C5
100-125 V AC 60 Hz	M242-156-G-PL-ZH-C6	M243-156-G-PL-ZH-C6	M244-156-G-PL-ZH-C6
200-250 V AC 60 Hz	M242-156-G-RN-ZH-C6	M243-156-G-RN-ZH-C6	M244-156-G-RN-ZH-C6
380-440 V AC 60 Hz	M242-156-G-RY-ZH-C6	M243-156-G-RY-ZH-C6	M244-156-G-RY-ZH-C6
6-30 V DC	-	M243-157-G-BU-ZH-DC	M244-157-G-BU-ZH-DC
12-36 V DC	M242-157-G-BU-ZH-DC	-	-
10-80 V DC	-	M243-157-G-NR-ZH-DC	M244-157-G-NR-ZH-DC
36-80 V DC	M242-157-G-NR-ZH-DC	-	-
110 V DC	M242-157-G-PM-ZH-DC	M243-157-G-PM-ZH-DC	M244-157-G-PM-ZH-DC

ELAPSED TIME/HOURS  
RUN METERS AC

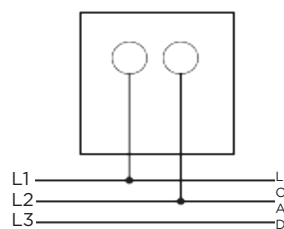

ELAPSED TIME/HOURS  
RUN METERS DC

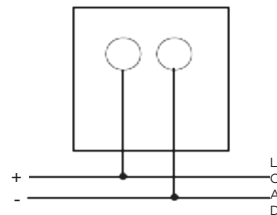

## FEATURES

- Measures AC frequencies of two independent systems
- Pointer type dual voltmeter and frequency meter with two independent 90° short scale movements
- Reed type available with two independent measuring circuits - 21 reeds (45-55 Hz, 55-65 Hz)
- Direct or VT connected



## CONSTRUCTION

- Pointer type contains internal transducer, powered from input voltage and moving coil meter
- Reed type uses steel reeds in an electromagnetic field. Reeds are calibrated to its individual frequency to vibrate in resonance with the electromagnet and vibrates at full amplitude
- Slot in screw fixing

## APPROVALS

- CE marked



## ORDER DATA/EXAMPLES

DUAL VOLTMETER - LV  
DIRECT CONNECTED

- 1) Select type: M244-80L,
- 2) Specify input voltage: 500 V,
- 3) Specify scaling: 0-500 V,
- 4) Specify frequency: 50 Hz

DUAL VOLTMETER - VT  
CONNECTED

- 1) Select type: M244-80L,
- 2) Specify input: 0-120 V,
- 3) Specify scaling: 0-12 kV,
- 4) Specify frequency: 50 Hz,
- 5) Specify VT ratio: 10/0.1 kV

DUAL FREQUENCY  
METER - POINTER TYPE

- 1) Select type: M244-41D,
- 2) Specify input voltage: 400 V,
- 3) Specify frequency: 45/65 Hz,
- 4) Specify scaling: 45-55-65 Hz

DUAL FREQUENCY METER -  
REED TYPE

- 1) Select type: M244-41E,
- 2) Specify input voltage: 110 V,
- 3) Specify frequency: 55/65 Hz,
- 4) Specify scaling: 55-60-65 Hz

## APPLICATIONS

- AC switchgears, panels and distribution boards
- Control board
- Generator sets

## BENEFITS

- Easy to operate
- High visibility
- Terminal cover included
- Marine approved

## GENERAL SPECIFICATION

Accuracy class dual voltmeter	1.5
Accuracy class dual frequency meter - pointer type	1
Accuracy class dual frequency meter - reed type	0.5
Overload	10xIn - 9x0.5s+1x5s/60s
Dual voltmeter	2xUn - 9x0.5s+1x5s/60s
Dual frequency meter - pointer type	1.2 x Un continuously, 1.5 x Un for 2 hours (pointer type only)
Dual frequency meter - reed type	2 x Un for 5 seconds
Burden frequency meter - pointer type	1 VA at nominal voltage 57 - 110 V and 230 V - 1.7 VA at nominal voltage 400 V - 2 VA at nominal voltage 500 V
Burden frequency meter - reed type	0.7 ... 1.2 VA at nominal voltage 110-230 V - 1.4 ... 2 VA at all other nominal voltages

## PRODUCT CODES

Bezel size (mm)	96	96	96	-
Scale length (mm)	41	41	-	-
Voltmeter meter 2 x 90°	M244-80L	-	-	-
Frequency meter 2 x 90°	-	M244-41D	-	-
Frequency meter 2 x 21 reeds	-	-	M244-41E	-

## Standard input ranges

Dual voltmeter (direct connected)	300 V, 500 V
Dual voltmeter (VT connected)	120 V (for use with VT's x/100 V), 132 V (for use with VT's x/110 V), 144 V (for use with VT's 120 V), 125 V, 137,5 V, 150 V (for use with some VT's having primary voltage less than 1 kV)
Dual frequency meter - pointer type	57-110 V, 400 V +/- 20%, 500 V +/-20%
Dual frequency meter - reed type	100 V, 110 V, 230 V, 400 V +/- 20%, 500 V +/-20%

## Scaling

Dual voltmeter	Specify to suit application
Dual frequency meter - pointer type	45-50-55 Hz, 55-60-55 Hz, 45-55-65 Hz
Dual frequency meter - reed type	45-50-55 Hz, 55-60-65 Hz

## CONNECTION DIAGRAMS

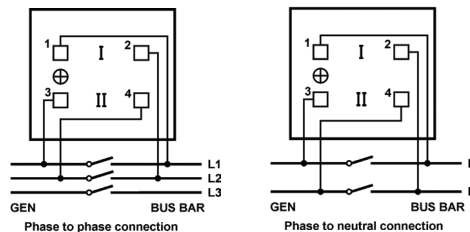



## Phase sequence indicators

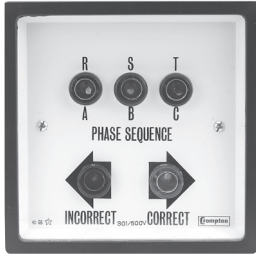

Electronic phase sequence indicators ensure correct phase rotation and the presence of all 3-phase supplies. Incorrect or loss of phase can cause serious damage in a wide range of electrical machines. Ship-to-shore supplies, mobile generators and remote installations are particularly vulnerable to this problem.

<b>Voltage</b>	151/300 V, 301/500 V 100/150 V (Model 244-12P only)
<b>Frequency</b>	50/60 Hz
<b>Burden</b>	2.5 VA/phase

DIMENSIONS		
<b>Bezel size mm</b>	72	96
<b>Product codes</b>		
<b>Phase sequence indicator</b>	243-12P	244-12P

### CONNECTIONS

#### PHASE SEQUENCE INDICATORS

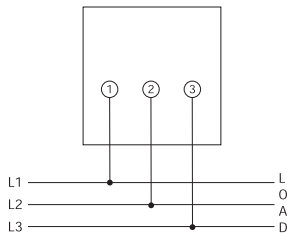

## Phase angle meters

Phase angle meters indicate the phase displacement between current and voltage. They are used in applications where the phase angle must be monitored, for example with tariffs having VAR penalties, or to optimise generator power delivery.

PRODUCT CODES - SHORT-SCALE MODELS		
DIMENSIONS		
<b>Bezel size mm</b>	72	96
<b>Scale length mm</b>	65	94
<b>Product codes</b>		
<b>3-phase 3/4-wire balanced load</b>	E243-42A	E244-42A

SPECIFICATIONS	
<b>Accuracy</b>	Class 1.5
<b>Ratings</b>	Current: 1 A or 5 A for CTs Voltage: 110 V, 240 V, 380 V & 400 V for VT use
<b>Frequency</b>	50 Hz, 60 Hz
<b>Burden at 50 Hz</b>	Current: 1 VA Voltage: 3 VA per phase
<b>Current range</b>	20-120%

### CONNECTIONS

#### 3-PHASE, 3/4-WIRE BALANCED SYSTEMS

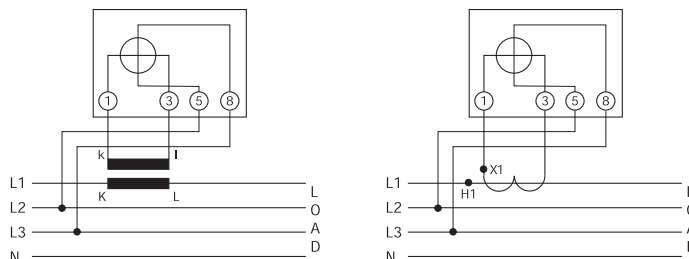

**FEATURES**

- Indicates Power factor of electrical systems
- Several voltage ranges available
- Current connection via “through hole” CT on the instrument. No need to interrupt wiring from CT

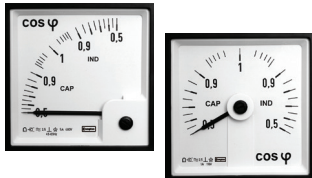

**APPLICATIONS**

- AC switchgears, panels and distribution boards
- Control boards
- Generator sets

**BENEFITS**

- Easy to operate
- High visibility
- Terminal cover included
- Low self consumption
- Internal power supply from voltage input

**GENERAL SPECIFICATION**

Accuracy class	1.5
Maximum continuous overload	3 x In, 1.5 x Un
Maximum short duration overload	25 x In for 30 seconds, 50 x In for 1 second, 2 x Un for 10 seconds
Voltage burden	<0.1 VA per phase
Current burden	<0.1 VA per phase
Frequency	50/60 Hz

**CONSTRUCTION**

- Instruments operate on a fast sampling method of input quantities (current and voltage) of the connected phases
- Meters include “through hole” CT connection, voltage dividers, internal microprocessor and power supply unit
- Slot in screw fixing

**APPROVALS**

- CE marked



**PRODUCT CODES**

Bezel size (mm)	96	96	96	96	96
Scale length (mm)	95	95	95	95	95
Power factor meter 90°	M244-420 single-phase	M244-421 3P/3W balanced	M244-42C 3P/4W balanced	M244-423 3P/3W unbalanced	M244-424 3P/4W unbalanced
Bezel size (mm)	96	96	96	96	96
Scale Length (mm)	135	135	135	135	135
Power factor meter 240°	M244-135 single-phase	M244-136 3P/3W balanced	M244-13D 3P/4W balanced	M244-138 3P/3W unbalanced	M244-139 3P/4W unbalanced

**Standard input ranges**

Single-phase, 3P/4W balanced, 3P/4W unbalanced	57.7 V L-N/1 A, 57.7 V L-N/5 A, 63.5 V L-N/1 A, 63.5 V L-N/5 A, 69.3 V L-N/1 A, 9.3 V L-N/5 A, 230 V L-N/1 A, 230 V L-N/5 A, 240 V L-N/1 A, 240 V L-N/5 A, 254 V L-N/1 A, 254 V L-N/5 A
3P/3W balanced, 3P/3W unbalanced	100 V L-L/1 A, 100 V L-L/5 A, 110 V L-L/1 A, 110 V L-L/5 A, 400 V L-L/1 A, 400 V L-L/5 A, 415 V L-L/1 A, 415 V L-L/5 A, 440 V L-L/1 A, 440 V L-L/5 A
Scaling	0.5/1/0.5 CAP/IND or 0.8/1/0.2 CAP/IND or 0.1/1/0/0.1 CAP/IND

**CONNECTION DIAGRAMS**

SINGLE-PHASE

3-PHASE 4-WIRE (3P/4W) BALANCED

3-PHASE 4-WIRE (3P/4W) UNBALANCED

3-PHASE 3-WIRE (3P/3W) BALANCED

3-PHASE 3-WIRE (3P/4W) UNBALANCED

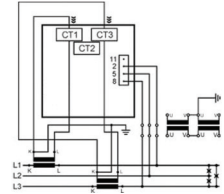
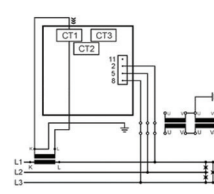
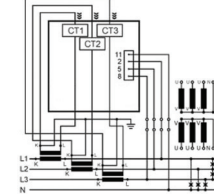
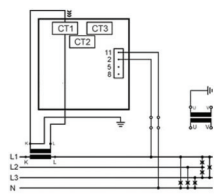
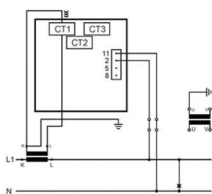

**ORDER DATA/EXAMPLES**

SINGLE-PHASE

- 1) Select type: M244-420,
- 2) Specify input voltage and current: 230 V L-N/5 A,
- 3) Specify scaling: 0.5/1/0.5 CAP/IND
- 4) Specify frequency: 50/60 Hz,

3-PHASE 4-WIRE BALANCED

- 1) Select type: M244-13D,
- 2) Specify input voltage and current: 69.3 V L-N/1 A,
- 3) Specify scaling: 0.5/1/0.5 CAP/IND,
- 4) Specify frequency: 50/60 Hz

3-PHASE 4-WIRE UNBALANCED

- 1) Select type: M244-424,
- 2) Specify input voltage and current: 230 V L-N/5 A,
- 3) Specify scaling: 0.8/1/0.2 CAP/IND
- 4) Specify frequency: 50/60 Hz

3-PHASE 3-WIRE BALANCED

- 1) Select type: M244-136,
- 2) Specify input voltage and current: 110 V L-L/5 A,
- 3) Specify scaling: 0.5/1/0.5 CAP/IND,
- 4) Specify frequency: 50/60 Hz

3-PHASE 3-WIRE UNBALANCED

- 1) Select type: M244-138,
- 2) Specify input voltage and current: 415 V L-L/1 A,
- 3) Specify scaling: 0.5/1/0.5CAP/IND,
- 4) Specify frequency: 50/60 Hz



### 360° LED SYNCHROSCOPE AND SYNCHRO CHECK RELAY

Where manual paralleling of two AC systems is desired, the frequency of both systems can be monitored by an LED synchroscope. The systems are synchronised when the green LED is lit in the 12 o'clock position. The instrument is rated for continuous operation and connection. For the semi-automatic paralleling of two AC systems, the voltage, phase displacement and the frequency of both systems can be monitored by this LED synchroscope and synchro check relay. Controls for voltage, phase angle, and time delay are provided. The systems are synchronised when the green triangular LEDs are lit together with the GEN/BUS green LEDs. A dead bus option is also available.

SPECIFICATIONS	
<b>Ratings voltage</b>	63.5, 110, 120, 220, 230, 240, 380, 400, 415, 440, 480 V 110/120 V (115 V nominal) 220/240 V (230 V nominal) 380/480 V (430 V nominal) Volts AC or via VT
<b>Frequency</b>	40/65 Hz
<b>Burden at 50Hz / 60Hz</b>	4 VA maximum Suitable for 1 or 3-phase systems
<b>Safety</b>	IEC1010-1 (300 V AC RMS installation degree 2)
<b>Dielectric</b>	4 kV rms for 1 minute
<b>Isolation</b>	BUS/GEN/RELAY
<b>Vibration</b>	To Lloyds shipping specification
<b>*Phase difference</b>	+0-20°, +2%
<b>*Voltage difference</b>	+0-20%, +/-2% 0-10% for models G and H
<b>*Time delay</b>	0-2.5 seconds +10%
<b>*Accuracy</b>	Synchronisation at T.DC is +1°

\*Only for the 360° LED synchroscope and synchro check relay.

DIMENSIONS			
<b>Bezel size mm</b>	96	96	96
<b>Scale length mm</b>	360° LED	360° LED	360° LED
<b>3- or 4-wire 40-65 Hz</b>	Synchroscope	Synchroscope and synchro check	Synchroscope and synchro check relay (dead bus)
Product codes			
<b>110/120 V</b>	-	244-14GG-POBX	244-14HG-POBX
<b>220/240 V</b>	-	244-14GG-R5BX	244-14HG-R5BX
<b>380/480 V</b>	-	244-14GG-RUBX	244-14HG-RUBX
<b>63.5 V</b>	244-14AG-NXYY	244-14LG-NXBX	244-14DG-NXBX
<b>110 V</b>	244-14AG-PMYY	244-14LG-PMBX	244-14DG-PMBX
<b>220 V</b>	244-14AG-R4YY	244-14LG-R4BX	244-14DG-R4BX
<b>230 V</b>	244-14AG-RQYY	244-14LG-RQBX	244-14DG-RQBX
<b>240 V</b>	244-14AG-RRYY	244-14LG-RRBX	244-14DG-RRBX
<b>380 V</b>	244-14AG-RUYY	244-14LG-RUBX	244-14DG-RUBX
<b>400 V</b>	244-14AG-SCYY	244-14LG-SCBX	244-14DG-SCBX
<b>415 V</b>	244-14AG-SBYY	244-14LG-SBBX	244-14DG-SBBX
<b>440 V</b>	244-14AG-SHYY	244-14LG-SHBX	244-14DG-SHBX
<b>480 V</b>	244-14AG-SEYY	244-14LG-SEBX	244-14DG-SEBX

For the 244-14L and 244-14D models, the generator voltage is compared to the nominal input (bus) voltage specified at time of ordering. For the 244-14G and 244-14H models, the generator voltage is compared to the measured bus voltage.

### CONNECTIONS

#### 360° LED SYNCHROSCOPE

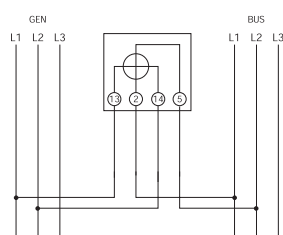

#### 360° LED SYNCHROSCOPE AND SYNCHRO CHECK RELAY

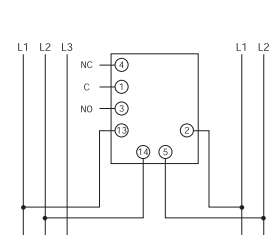

**FEATURES**

- Typically used to measure between Busbar and Generator
- Available as LED indicator only, LED indicator with LCD display, LED indicator with synchro check relay, LED indicator with LCD display and synchro check relay



**CONSTRUCTION**

- Instruments are microprocessor based
- Slot in screw fixing

**STANDARDS**

- CE marked



**APPLICATIONS**

- Used on manual and semi-automatic synchronising applications
- AC switchgears, panels and distribution boards
- Generator sets

**BENEFITS**

- Supports damage prevention on expensive assets
- Simple synchronisation conditions setting
- High visibility
- Terminal cover included
- Low self consumption
- Up to five meters in one unit

GENERAL SPECIFICATION	
<b>Synchronising functions</b>	
Voltage difference setting ( $\Delta U$ )	1.5
Accuracy	+/- 2.5%
Phase difference setting	2 ... 20° el.
Accuracy	+/- 3° el.
Time delay synchronisation	0.1 ... 1 s.
Accuracy	+/- 10%
Synchronisation pulse duration	300 ms
Accuracy	+/- 30 ms
Nominal frequency range	45/65 Hz
Output relay specification	250 V, 6A, 50 Hz, 1500 VA
Voltage burden	<4 VA
Overload	1.2 x Un permanently, 2 x Un for 3s
<b>LED functions</b>	
Resolution $\Delta \phi$ display	20° el.
Magnified resolution range	+/- 15° el.
Magnified resolution	5° el.
Accuracy at $\Delta \phi = 0$	+/- 3° el.
<b>LCD functions</b>	
Accuracy voltage display	+/- 1.5%
Accuracy frequency display	+/- 0.5%
Phase difference accuracy Ugen to Ubb	+/- 3° el.

PRODUCT CODES			
Bezel size (mm)	96	96	96
	M244-14A-S LED only	M244-14L-S LED & synchro check relay	M244-14D-S LED & synchro check relay with deadbus option
Bezel size (mm)	96	96	96
		M244-14M-S LED & synchro check relay & LCD	M244-14E-S LED & synchro check relay with deadbus option & LCD display
<b>Standard input ranges</b>			
Voltage	100 V L/L, 110 V L/L400 V L/L, 415 V L/L, 440 V L/L		

**CONNECTION DIAGRAMS**

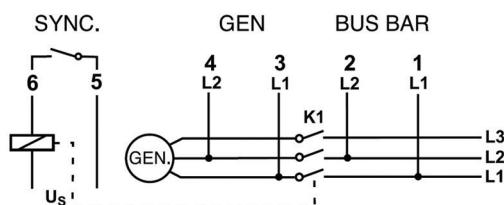

**ORDER DATA/EXAMPLES**

- 1) Select type: M244-14M-S,
- 2) Specify input voltage: 415 V,
- 3) Specify display or output:  
Relay output,
- 4) Specify frequency: 45-65 Hz,
- 5) Specify functional description:  
Output duration 300ms

**FEATURES**

- Indicates active power of electrical systems
- Several voltage ranges available
- Current connection via “through hole” CT on the instrument

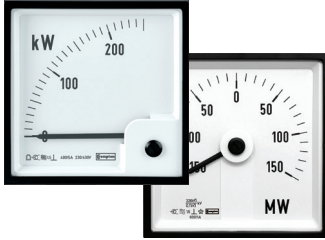

**CONSTRUCTION**

- Instruments operate on a fast sampling method of input quantities (current and voltage) of the connected phases
- Meters include “through hole” CT connection, voltage dividers, internal microprocessor and power supply unit
- Slot in screw fixing

**APPROVALS**

- CE marked



**APPLICATIONS**

- AC switchgears, panels and distribution boards
- Control boards
- Generator sets

**BENEFITS**

- Easy to operate
- Exchangeable dial
- Terminal cover included

- Accuracy class - 1.5
- Maximum continuous overload - 3 x In, 1.5 x Un
- Maximum short duration overload - 25 x In for 30 seconds, 50 x In for 1 second, 2 x Un for 10 seconds
- Voltage burden - <0.1 VA per phase
- Current burden - <0.1 VA per phase
- Frequency - 50/60 Hz

PRODUCT CODES					
Bezel size (mm)	96	96	96	96	96
Scale length (mm)	95	95	95	95	95
Wattmeter 90°	M244-210 single-phase	M244-211 3P/3W balanced	M244-21C 3P/4W balanced	M244-213 3P/3W unbalanced	M244-214 3P/4W unbalanced
Bezel size (mm)	96	96	96	96	96
Scale Length (mm)	135	135	135	135	135
Wattmeter 240°	M244-215 single-phase	M244-216 3P/3W balanced	M244-21D 3P/4W balanced	M244-218 3P/3W unbalanced	M244-219 3P/4W unbalanced
Standard input ranges					
Single-phase, 3P/4W balanced, 3P/4W unbalanced	57.7 V L-N/1A, 57.7 V L-N/5A, 63.5 V L-N/1A, 63.5 V L-N/5 A, 230 V L-N/1 A, 230 V L-N/5 A, 240 V -N/1 A, 240 V L-N/5 A, 254 V L-N/1 A, 254 V L-N/5 A,				
3P/3W balanced, 3P/3W unbalanced	100 V L-L/1 A, 100 V L-L/5 A, 110 V L-L/1 A, 110 V L-L/5 A, 400 V L-L/1 A, 400 V L-L/5 A, 415 V L-L/1 A, 415 V L-L/5 A, 440 V L-L/1 A, 440 V L-L/5 A				

**CALCULATION OF END SCALE VALUE**

End scale value is calculated using the formula below, where correct voltage must be selected (either L-N or L-L), depending on the electrical system and the type of meter used. Scale factor, e.g. the relation between end scale value and nominal apparent power (cos-phi = 1) must be between 0.6 to 1.2. It is recommended selecting the scale value from 1 - 1.2 - 1.25 - 1.5 - 2 - 2.5 - 3 - 4 - 5 - 6 - 7.5 - 8 (and their decades) closest to the calculated result.

ELECTRICAL SYSTEM	FORMULA	EXAMPLE	END SCALE VALUE TO CHOOSE (CONSIDERING 0,6 TO 1.2 X S)
<b>Single-phase, direct voltage connection</b>	$P = U(L-N) \times I_p \times \cos$	$P = 230 \text{ V} \times 50 \text{ A} \times 0,9 = 10350 \text{ W} = 10,35 \text{ kW}$	10 kW
<b>3-phase 4-wire, direct voltage connection (balanced or unbalanced)</b>	$P = 3 \times U(L-N) \times I_p \times \cos$	$P = 3 \times 230 \text{ V} \times 400 \text{ A} \times 0,95 = 262200 \text{ W} = 262,2 \text{ kW}$	250 kW
<b>3-phase 3-wire, direct voltage connection (balanced or unbalanced)</b>	$P = 1,732 \times U(L-L) \times I_p \times \cos$	$P = 1,732 \times 400 \text{ V} \times 1000 \text{ A} \times 0,9 = 623520 \text{ W} = 623,52 \text{ kW}$	600 kW
<b>3-phase 4-wire, voltage connection via VT (balanced or unbalanced)</b>	$P = 3 \times U_p(L-N) \times I_p \times \cos$	$P = 3 \times 5770 \text{ V} \times 100 \text{ A} \times 0,95 = 1644450 \text{ W} = 1,64445 \text{ MW}$	1.5 MW
<b>3-phase 3-wire, voltage connection via VT (balanced or unbalanced)</b>	$P = 1,732 \times U_p(L-L) \times I_p \times \cos$	$P = 1,732 \times 30000 \text{ V} \times 50 \text{ A} \times 0,9 = 2338200 \text{ W} = 2,3382 \text{ MW}$	2.5 MW

**ORDER DATA/EXAMPLES**

SINGLE-PHASE

- 1) Select type: M244-210,
- 2) Specify input voltage and CT ratio: 230 V L-N, 50/5 A,
- 3) Specify scaling: 0 - 10 kW,
- 4) Specify frequency: 50/60 Hz,

3-PHASE 4-WIRE BALANCED OR 3-PHASE 4-WIRE UNBALANCED

- 1) Select type: M244-21D,
- 2) Specify input voltage and CT ratio: 230 V L-N, 400/5 A,
- 3) Specify scaling: 0-250 kW,
- 4) Specify frequency: 50/60 Hz

OR UNBALANCED

- 1) Select type: M244-213,
- 2) Specify input voltage and CT ratio: 400 V L-L, 1000/1 A,
- 3) Specify scaling: 0 - 600 kW,
- 4) Specify frequency: 50/60 Hz

3-PHASE 4-WIRE BALANCED OR UNBALANCED, VT CONNECTED

- 1) Select type: M244-214,
- 2) Specify VT ratio and CT ratio: 5770/57.7 V L-N, 100/5 A,
- 3) Specify scaling: 0-1.5 MW,
- 4) Specify frequency: 50/60 Hz

3-PHASE 3-WIRE BALANCED OR UNBALANCED

- 1) Select type: M244-218,
- 2) Specify input VT ratio and CT ratio: 30000/110 V L-L, 50/1 A,
- 3) Specify scaling: 0 - 2.5 MW
- 4) Specify frequency: 50/60 Hz

**FEATURES**

- Indicates reactive power of electrical systems
- Several voltage ranges available
- Current connection via “through hole” CT on the instrument

**APPLICATIONS**

- AC switchgears, panels and distribution boards
- Control boards
- Generator sets

**BENEFITS**

- Easy to operate
- High visibility
- Terminal cover included
- Low self consumption
- Internal power supply from voltage input

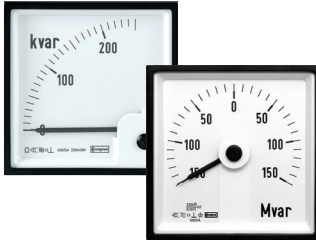

**CONSTRUCTION**

- Instruments operate on a fast sampling method of input quantities (current and voltage) of the connected phases.
- Meters include “through hole” CT connection, voltage dividers, internal microprocessor and power supply unit.
- Slot in screw fixing

**APPROVALS**

- CE marked



GENERAL SPECIFICATION	
Accuracy class	1.5
Maximum continuous overload	3 x In, 1.5 x Un
Maximum short duration overload	25 x In for 30 seconds, 50 x In for 1 second, 2 x Un for 10 seconds
Voltage burden	<0.1 VA per phase
Current burden	<0.1 VA per phase
Frequency	50/60 Hz

PRODUCT CODES					
Bezel size (mm)	96	96	96	96	96
Scale Length (mm)	95	95	95	95	95
Varmeter 90°	M244-310 single-phase	M244-311 3P/3W balanced	M244-31C 3P/4W balanced	M244-313 3P/3W unbalanced	M244-314 3P/4W unbalanced
Bezel size (mm)	96	96	96	96	96
Scale length (mm)	135	135	135	135	135
Varmeter 240°	M244-315 single-phase	M244-316 3P/3W balanced	M244-31D 3P/4W balanced	M244-318 3P/3W unbalanced	M244-319 3P/4W unbalanced
Standard input ranges					
Single-phase, 3P/4W balanced, 3P/4W unbalanced	57.7 V L-N/1 A, 57.7 V L-N/5 A, 63.5 V L-N/1 A, 63.5 V L-N/5 A, 230 V L-N/1 A, 230 V L-N/5 A, 240 V L-N/1 A, 240 V L-N/5 A, 254 V L-N/1 A, 254 V L-N/5 A				
3P/3W balanced, 3P/3W unbalanced	100 V L-L/1 A, 100 V L-L/5 A, 110 V L-L/1 A, 110 V L-L/5 A, 400 V L-L/1 A, 400 V L-L/5 A, 415 V L-L/1 A, 415 V L-L/5 A, 440 V L-L/1 A, 440 V L-L/5 A				

**CALCULATION OF END SCALE VALUE**

End scale value is calculated using the formula below, where correct voltage must be selected (either L-N or L-L), depending on the electrical system and the type of meter used. Scale factor, e.g. the relation between end scale value and nominal apparent power (cos-phi = 1) must be between 0.6 to 1.2. It is recommended selecting the scale value from 1 - 1.2 - 1.25 - 1.5 - 2 - 2.5 - 3 - 4 - 5 - 6 - 7.5 - 8 (and their decades) closest to the calculated result. Ip = CT primary current, Up = VT primary voltage, U = direct connected voltage, sin φ = power factor.

ELECTRICAL SYSTEM	FORMULA	EXAMPLE	END SCALE VALUE TO CHOOSE (CONSIDERING 0,6 TO 1.2 X S)
<b>Single-phase, direct voltage connection</b>	$Q = U(L-N) \times I_p \times \sin \phi$	$Q = 230V \times 50A \times 0.44 = 5060 \text{ var} = 5,06 \text{ kvar}$	6 kvar
<b>3-phase 4-wire, direct voltage connection (balanced or unbalanced)</b>	$Q = 3 \times U(L-N) \times I_p \times \sin$	$P = 3 \times 230V \times 400A \times 0.31 = 85560 \text{ var} = 85,56 \text{ kvar}$	200 kvar
<b>3-phase 3-wire, direct voltage connection (balanced or unbalanced)</b>	$Q = 1.732 \times U(L-L) \times I_p \times \sin$	$P = 1.732 \times 400V \times 1000A \times 0,44 = 304832 \text{ var} = 304,8 \text{ kvar}$	500 kvar
<b>3-phase 4-wire, voltage connection via VT (balanced or unbalanced)</b>	$Q = 3 \times U_p(L-N) \times I_p \times \sin$	$P = 3 \times 5770V \times 100A \times 0.199 = 344469 \text{ var} = 344,469 \text{ kvar}$	1 Mvar
<b>3-phase 3-wire, voltage connection via VT (balanced or unbalanced)</b>	$Q = 1.732 \times U_p(L-L) \times I_p \times \sin$	$P = 1.732 \times 30000V \times 50A \times 0,44 = 1143120 \text{ var} = 1,14312 \text{ Mvar}$	2 Mvar

**ORDER DATA/EXAMPLES**

SINGLE-PHASE

- 1) Select type: M244-310,
- 2) Specify input voltage and CT ratio: 230 V L-N, 50/5 A,
- 3) Specify scaling: 0 - 6 kvar,
- 4) Specify frequency: 50/60 Hz,

3-PHASE 4-WIRE BALANCED OR 3-PHASE 4-WIRE UNBALANCED

- 1) Select type: M244-31D,
- 2) Specify input voltage and CT ratio: 230 V L-N, 400/5 A,
- 3) Specify scaling: 0 - 200 kvar,
- 4) Specify frequency: 50/60 Hz

3-PHASE 3-WIRE BALANCED OR UNBALANCED

- 1) Select type: M244-313,
- 2) Specify input voltage and CT ratio: 400 V L-L, 1000/1 A,
- 3) Specify scaling: 0 - 500 kvar,
- 4) Specify frequency: 50/60 Hz

3-PHASE 4-WIRE BALANCED OR UNBALANCED, VT CONNECTED

- 1) Select type: M244-314,
- 2) Specify VT ratio and CT ratio: 5770/57.7 V L-N, 100/5 A,
- 3) Specify scaling: 0 - 1 Mvar,
- 4) Specify frequency: 50/60 Hz

3-PHASE 3-WIRE BALANCED OR UNBALANCED

- 1) Select type: M244-318,
- 2) Specify input VT ratio and CT ratio: 30000/110 V L-L, 50/1 A,
- 3) Specify scaling: 0 - 2 Mvar,
- 4) Specify frequency: 50/60 Hz





**WIRING DIAGRAMS OF WATTMETERS AND VARMETERS**

**SINGLE-PHASE, DIRECT OR VT VOLTAGE CONNECTION**

- Wattmeter M244-210
- Wattmeter M244-215
- Varmeter M244-310
- Varmeter M244-315

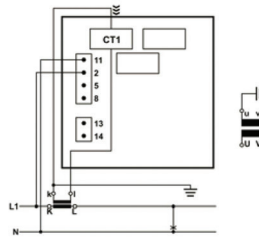

**3-PHASE 3-WIRE BALANCED, DIRECT OR VT VOLTAGE CONNECTION**

- Wattmeter M244-211
- Wattmeter M244-216
- Varmeter M244-311
- Varmeter M244-316

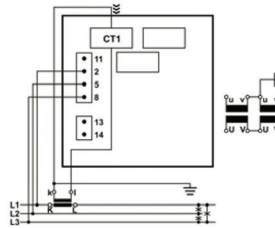

**3-PHASE 4-WIRE BALANCED, DIRECT OR VT VOLTAGE**

- Wattmeter M244-21C
- Wattmeter M244-21D
- Varmeter M244-31C
- Varmeter M244-31D

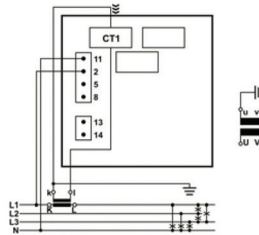

**3-PHASE 3-WIRE UNBALANCED, DIRECT OR VT VOLTAGE CONNECTION**

- Wattmeter M244-213
- Wattmeter M244-218
- Varmeter M244-313
- Varmeter M244-318

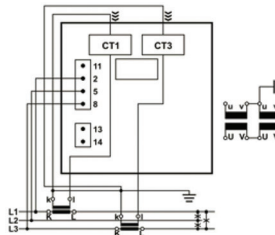

**3-PHASE 4-WIRE UNBALANCED, DIRECT OR VT VOLTAGE CONNECTION**

- Wattmeter M244-214
- Wattmeter M244-219
- Varmeter M244-314
- Varmeter M244-319

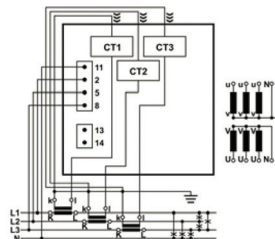

**FEATURES**

- Counts electrical active energy and indicates active power of electrical systems
- Several voltage ranges available
- Current connection via “through hole” CT on the instrument. No need to interrupt wiring from CT
- Pulsed output as standard

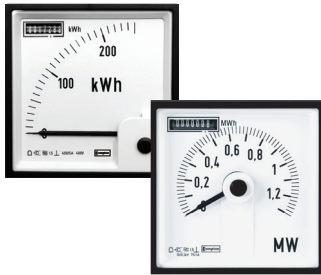

**CONSTRUCTION**

- Instruments operate on a fast sampling method of input quantities (current and voltage) of the connected phases
- Meters include “through hole” CT connection, voltage dividers, internal microprocessor and power supply unit
- Slot in screw fixing

**APPROVALS**

- CE marked
- BV approved



**APPLICATIONS**

- AC switchgears, panels and distribution boards
- Control boards
- Generator sets

**BENEFITS**

- High visibility
- Terminal cover included
- Low self consumption
- Separated power supply

GENERAL SPECIFICATION	
Accuracy class active power meter	1.5
Accuracy class active energy meter	1 to EN 62053-21
Maximum continuous overload	2 x In, 1.2 x Un
Nominal frequency	50/60 Hz
Voltage burden	<0.1 VA per phase
Current burden	<0.1 VA per phase
Power supply	Various AC volts between 57.7 and 400
Frequency	40-65 Hz
Voltage burden	<3 VA
Pulsed output	1 SO pulsed output with 1p/10kWh, 1p/100kWh, 1p/10MWh, 1p/100MWh. Maximum pulse rate may not exceed 33 pulses per second (1980 pulses per minute). If in doubt choose next higher value, e.g. 1p/100/kWh instead of 1p/10kWh

PRODUCT CODES					
Bezel size (mm)	96	96	96	96	96
Scale length (mm)	95	95	95	95	95
Active energy meter with Wattmeter 90°	M244-HWG single-phase	M244-HWH 3P/3W balanced	M244-HWV 3P/4W balanced	M244-HWJ 3P/3W unbalanced	M244-HWK 3P/4W unbalanced
Bezel size (mm)	96	96	96	96	96
Scale Length (mm)	135	135	135	135	135
Active energy meter with Wattmeter 240°	M244-HWB single-phase	M244-HWC 3P/3W balanced	M244-HWU 3P/4W balanced	M244-HWD 3P/3W unbalanced	M244-HWE 3P/4W unbalanced

Standard input ranges	
Single-phase, 3P/4W balanced & unbalanced	57.7 V L-N/1 A, 57.7 V L-N/5 A, 63.5 V L-N/1 A, 63.5 V L-N/5 A, 230 V L-N/1 A, 230 V L-N/5 A, 240 V L-N/1 A, 240 V L-N/5 A, 254 V L-N/1 A, 254 V L-N/5 A,
3P/3W balanced & unbalanced	1100 V L-L/1 A, 100 V L-L/5 A, 110 V L-L/1 A, 110 V L-L/5 A, 400 V L-L/1 A, 400 V L-L/5 A, 415 V L-L/1 A, 415 V L-L/5 A, 440 V L-L/1 A, 440 V L-L/5 A

**CALCULATION OF END SCALE VALUE**

End scale value is calculated using the formula below, where correct voltage must be selected (either L-N or L-L), depending on the electrical system and the type of meter used. Scale factor, e.g. the relation between end scale value and nominal apparent power (cos-phi = 1) must be between 0.6 to 1.2. It is recommended selecting the scale value from 1 - 1.2 - 1.25 - 1.5 - 2 - 2.5 - 3 - 4 - 5 - 6 - 7.5 - 8 (and their decades) closest to the calculated result. Ip = CT primary current, Up = VT primary voltage, U = direct connected voltage, cos φ = power factor.

ELECTRICAL SYSTEM	FORMULA	EXAMPLE	END SCALE VALUE TO CHOOSE (CONSIDERING 0,6 TO 1.2 X S)
<b>Single-phase, direct voltage connection</b>	$P = U(L-N) \times I_p \times \cos$	$P = 230 \text{ V} \times 50 \text{ A} \times 0.9 = 10350 \text{ W} = 10.35 \text{ kW}$	10 kW
<b>3-phase 4-wire, direct voltage connection (balanced or unbalanced)</b>	$P = 3 \times U(L-N) \times I_p \times \cos$	$P = 3 \times 230 \text{ V} \times 400 \text{ A} \times 0.95 = 262200 \text{ W} = 262.2 \text{ kW}$	250 kW
<b>3-phase 3-wire, direct voltage connection (balanced or unbalanced)</b>	$P = 1.732 \times U(L-L) \times I_p \times \cos$	$P = 1.732 \times 400 \text{ V} \times 1000 \text{ A} \times 0.9 = 623520 \text{ W} = 623.52 \text{ kW}$	600 kW
<b>3-phase 4-wire, voltage connection via VT (balanced or unbalanced)</b>	$P = 3 \times U_p(L-N) \times I_p \times \cos$	$P = 3 \times 5770 \text{ V} \times 100 \text{ A} \times 0.95 = 1644450 \text{ W} = 1.64445 \text{ MW}$	1.5 MW
<b>3-phase 3-wire, voltage connection via VT (balanced or unbalanced)</b>	$P = 1.732 \times U_p(L-L) \times I_p \times \cos$	$P = 1.732 \times 30000 \text{ V} \times 50 \text{ A} \times 0.9 = 2338200 \text{ W} = 2.3382 \text{ MW}$	2.5 MW

## ORDER DATA/EXAMPLES

### SINGLE-PHASE

- 1) Select type: M244-HWG,
- 2) Specify input voltage and CT ratio: 230 V L-N, 50/5 A,
- 3) Spec. scaling: 0-10 kW,
- 4) Spec. frequency: 50/60 Hz,
- 5) Select pulse rate: 1p/10 kWh,
- 6) Select output: 1 pulsed output

### 3-PHASE 4-WIRE BALANCED OR 3-PHASE 4-WIRE UNBALANCED

- 1) Select type: M244-HWK,
- 2) Specify input voltage and CT ratio: 230 V L-N, 400/5 A,
- 3) Spec. scaling: 0-250 kW,
- 4) Spec. frequency: 50/60 Hz,
- 5) Select pulse rate: 1p/10 kWh,
- 6) Select output: 1 puls. o/p

### 3-PHASE 3-WIRE BALANCED OR UNBALANCED

- 1) Select type: M244-HWJ,
- 2) Specify input voltage and CT ratio: 400 V L-L, 1000/1 A,
- 3) Spec. scaling: 0-600 kW,
- 4) Spec. frequency: 50/60 Hz,
- 5) Select pulse rate: 1p/10 kWh,
- 6) Select output: 1 puls. o/p

### 3-PHASE 4-WIRE BALANCED OR UNBALANCED, VT CONNECTED

- 1) Select type: M244-HWU,
- 2) Specify VT ratio and CT ratio: 5770/57.7 V L-N, 100/5 A,
- 3) Spec. scaling: 0-1.5 MW,
- 4) Spec. frequency: 50/60 Hz,
- 5) Select pulse rate: 1p/100 kWh,
- 6) Select output: 1 pulsed output

### 3-PHASE 3-WIRE BALANCED OR UNBALANCED

- 1) Select type: M244-HWD,
- 2) Specify input VT ratio and CT ratio: 30000/110 V L-L, 50/1 A,
- 3) Spec. scaling: 0-2.5 MW
- 4) Spec. frequency: 50/60 Hz,
- 5) Select pulse rate: 1p/100 kWh,
- 6) Select output: 1 pulsed output

**FEATURES**

- Counts electrical reactive energy and indicates reactive power of electrical systems
- Several voltage ranges available
- Current connection via “through hole” CT on the instrument. No need to interrupt wiring from CT
- Pulsed output as standard



**APPLICATIONS**

- AC switchgears, panels and distribution boards
- Control boards
- Generator sets

**CONSTRUCTION**

- Instruments operate on a fast sampling method of input quantities (current and voltage) of the connected phases
- Meters include “through hole” CT connection, voltage dividers, internal microprocessor and power supply unit
- Slot in screw fixing

**APPROVALS**

- CE marked
- BV approved



**BENEFITS**

- High visibility
- Terminal cover included
- Low self consumption
- Separated power supply

GENERAL SPECIFICATION	
Accuracy class reactive power meter	1.5
Accuracy class reactive energy meter	2 to EN 62053-23
Maximum continuous overload	2 x In, 1.2 x Un
Nominal frequency	50/60 Hz
Voltage burden	<0.1 VA per phase
Current burden	<0.1V A per phase
Power supply	Various AC volts between 57.7 and 400
Frequency	40-65 Hz
Voltage burden	<3 VA
Pulsed output	1 SO pulsed output with 1p/10 kWh, 1p/100 kWh, 1p/10 MWh, 1p/100 MWh. Maximum pulse rate may not exceed 33 pulses per second (1980 pulses per minute). If in doubt choose next higher value, e.g. 1p/100/ kWh instead of 1p/10 kWh

PRODUCT CODES					
Bezel size (mm)	96	96	96	96	96
Scale length (mm)	95	95	95	95	95
Reactive energy meter with Varmeter 90°	M244-HXG single-phase	M244-HXH 3P/3W balanced	M244-HXV 3P/4W balanced	M244-HXJ 3P/3W unbalanced	M244-HXK 3P/4W unbalanced
Bezel size (mm)	96	96	96	96	96
Scale Length (mm)	135	135	135	135	135
Reactive energy meter with Varmeter 240°	M244-HXB single-phase	M244-HXC 3P/3W balanced	M244-HXU 3P/4W balanced	M244-HXD 3P/3W unbalanced	M244-HXE 3P/4W unbalanced
Standard input ranges					
Single-phase, 3P/4W balanced & unbalanced	57.7 V L-N/1 A, 57.7 V L-N/5 A, 63.5 V L-N/1 A, 63.5 V L-N/5 A, 230 V L-N/1 A, 230 V L-N/5 A, 240 V L-N/1 A, 240 V L-N/5 A, 254 V L-N/1 A, 254 V L-N/5 A,				
3P/3W balanced & unbalanced	100 V L-L/1 A, 100 V L-L/5 A, 110 V L-L/1 A, 110 V L-L/5 A, 400 V L-L/1 A, 400 V L-L/5 A, 415 V L-L/1 A, 415 V L-L/5 A, 440 V L-L/1 A, 440 V L-L/5 A				

**CALCULATION OF END SCALE VALUE**

End scale value is calculated using the formula below, where correct voltage must be selected (either L-N or L-L), depending on the electrical system and the type of meter used. Scale factor, e.g. the relation between end scale value and nominal apparent power (cos-phi = 1) must be between 0.6 to 1.2. It is recommended selecting the scale value from 1 - 1.2 - 1.25 - 1.5 - 2 - 2.5 - 3 - 4 - 5 - 6 - 7.5 - 8 (and their decades) closest to the calculated result. Ip = CT primary current, Up = VT primary voltage, U = direct connected voltage, sin φ = power factor.

ELECTRICAL SYSTEM	FORMULA	EXAMPLE	END SCALE VALUE TO CHOOSE (CONSIDERING 0.6 TO 1.2 X S)
Single-phase, direct voltage connection	$P = U(L-N) \times I_p \times \sin$	$Q = 230 \text{ V} \times 50 \text{ A} \times 0.44 = 5060 \text{ var} = 5.06 \text{ kvar}$	6 kvar
3-phase 4-wire, direct voltage connection (balanced or unbalanced)	$P = 3 \times U(L-N) \times I_p \times \sin \phi$	$P = 3 \times 230 \text{ V} \times 40 \text{ OA} \times 0.31 = 85560 \text{ var} = 85.56 \text{ kvar}$	200 kvar
3-phase 3-wire, direct voltage connection (balanced or unbalanced)	$P = 1.732 \times U(L-L) \times I_p \times \sin$	$P = 1.732 \times 400 \text{ V} \times 1000 \text{ A} \times 0.44 = 304832 \text{ var} = 304.8 \text{ kvar}$	500 kvar
3-phase 4-wire, voltage connection via VT (balanced or unbalanced)	$P = 3 \times U_p(L-N) \times I_p \times \sin$	$P = 3 \times 5770 \text{ V} \times 100 \text{ A} \times 0.199 = 344469 \text{ var} = 344.469 \text{ kvar}$	1 Mvar
3-phase 3-wire, voltage connection via VT (balanced or unbalanced)	$P = 1.732 \times U_p(L-L) \times I_p \times \sin$	$P = 1.732 \times 30000 \text{ V} \times 50 \text{ A} \times 0.44 = 1143120 \text{ var} = 1.14312 \text{ Mvar}$	2 Mvar

### ORDER DATA/EXAMPLES

#### SINGLE-PHASE

- 1) Select type: M244-HXG,
- 2) Specify input voltage and CT ratio: 230 V L-N, 50/5 A,
- 3) Spec. scaling: 0-6 kvar,
- 4) Spec. frequency: 50/60 Hz,
- 5) Select pulse rate: 1p/10 kvarh,
- 6) Select output: 1 pulsed output

#### 3-PHASE 4-WIRE BALANCED OR 3-PHASE 4-WIRE UNBALANCED

- 1) Select type: M244-HXK,
- 2) Specify input voltage and CT ratio: 230 V L-N, 400/5 A,
- 3) Spec. scaling: 0-200 kvar,
- 4) Spec. frequency: 50/60 Hz,
- 5) Select pulse rate: 1p/10 kvarh,
- 6) Select output: 1 pul. O/P

#### 3-PHASE 3-WIRE BALANCED OR UNBALANCED

- 1) Select type: M244-HXJ,
- 2) Spec. input voltage and CT ratio: 400 V L-L, 1000/1 A,
- 3) Spec. scaling: 0-500 kvar,
- 4) Spec. frequency: 50/60 Hz ,
- 5) Select pulse rate: 1p/10 kvarh,
- 6) Select output: 1 pul. O/P

#### 3-PHASE 4-WIRE BALANCED OR UNBALANCED, VT CONNECTED

- 1) Select type: M244-HXU,
- 2) Specify VT ratio and CT ratio: 5770/57.7 V L-N, 100/5 A,
- 3) Spec. scaling: 0-1 M var,
- 4) Spec. frequency: 50/60 Hz,
- 5) Select pulse rate: 1p/100 kvarh,
- 6) Select output: 1 pul. O/P

#### 3-PHASE 3-WIRE BALANCED OR UNBALANCED

- 1) Select type: M244-HXD,
- 2) Specify input VT ratio and CT ratio: 30000/110 V L-L, 50/1 A,
- 3) Spec. scaling: 0-2 Mvar
- 4) Spec. frequency: 50/60 Hz,
- 5) Select pulse rate: 1p/100 kWh,
- 6) Select output: 1 pulsed O/P

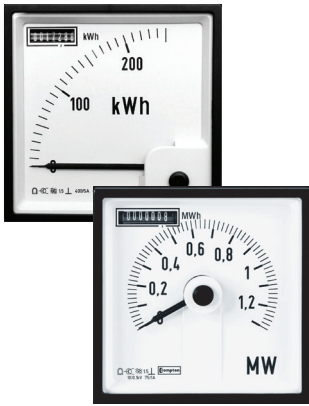

**WIRING DIAGRAMS ENERGY METERS**

**SINGLE-PHASE, DIRECT OR VT VOLTAGE CONNECTION**

Active Energy Meter M244-HWG  
 Active Energy Meter M244-HWB  
 Reactive Energy Meter M244-HXI  
 Reactive Energy Meter M244-HX

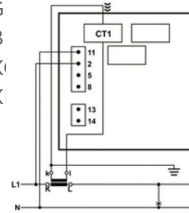

Power supply:  
 Terminal 13 and 14  
 Pulsed output:  
 Terminal 15 and 16

**3-PHASE 3-WIRE BALANCED, DIRECT OR VT VOLTAGE CONNECTION**

Active Energy Meter M244-HWH  
 Active Energy Meter M244-HWC  
 Reactive Energy Meter M244-HXI  
 Reactive Energy Meter M244-HX

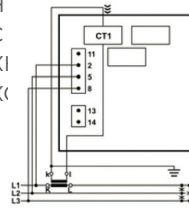

Power supply:  
 Terminal 13 and 14  
 Pulsed output:  
 Terminal 15 and 16

**3-PHASE 4-WIRE BALANCED, DIRECT OR VT VOLTAGE CONNECTION**

Active Energy Meter M244-HWV  
 Active Energy Meter M244-HWU  
 Reactive Energy Meter M244-HX'  
 Reactive Energy Meter M244-HXI

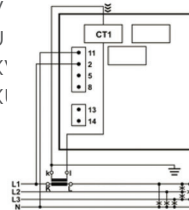

Power supply:  
 Terminal 13 and 14  
 Pulsed output:  
 Terminal 15 and 16

**3-PHASE 3-WIRE UNBALANCED, DIRECT OR VT VOLTAGE CONNECTION**

Active Energy Meter M244-HWJ  
 Active Energy Meter M244-HWD  
 Reactive Energy Meter M244-HX.  
 Reactive Energy M244-HXD

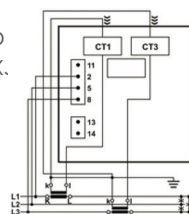

Power supply:  
 Terminal 13 and 14  
 Pulsed output:  
 Terminal 15 and 16

**3-PHASE 4-WIRE UNBALANCED, DIRECT OR VT VOLTAGE CONNECTION**

Active Energy Meter M244-HWK  
 Active Energy Meter M244-HWE  
 Reactive Energy Meter M244-HX  
 Reactive Energy Meter M244-HX

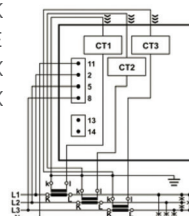

Power supply:  
 Terminal 13 and 14  
 Pulsed output:  
 Terminal 15 and 16

**FEATURES**

- Monitoring of transformer tap position, hoist or valve position
- 3 wire system
- 21 position using 10Ω to 400Ω steps
- Moving coil indicator
- Stabilised power supply and transducer
- CE Approved



**APPLICATIONS**

- Monitor transformer tap position, hoist or valve position

**BENEFITS**

- Interchangeable dial
- Resistant to mechanical vibrations and shocks
  - Protective cover for terminal
  - Linear scale

PRODUCT CODES	
Model	Function
M244-45P	96 DIN tap position indicator
M246-45P	144 DIN tap position indicator

SPECIFICATIONS	
<b>Accuracy</b>	
<b>Class</b>	1.5
<b>Measuring</b>	
<b>Auxiliary supply</b>	110-220 V ±15% AC/DC
<b>Bridge system</b>	10Ω to 400Ω per step
<b>Environmental</b>	
<b>Operating temperature</b>	25 to 55 °C
<b>Storage temperature</b>	-40 to 70 °C
<b>Relative humidity</b>	≤ 80 % yearly average, no condensation
<b>Enclosure</b>	
<b>Material</b>	Flame retardant plastic (UL94V-0)
<b>Enclosure protection</b>	IP 52 (IP 00 for connection terminals, IP 20 connection terminals with protection)
<b>Mounting</b>	Fixing element to panel
<b>Weight</b>	0.2 kg
<b>Safety</b>	
<b>Voltage</b>	2 kV rms EN61010-1

Note: The remote potentiometer or resistance thermometer sensor to be supplied by the customer. Consult factory for custom positions and steps.

**CONNECTION DIAGRAMS**

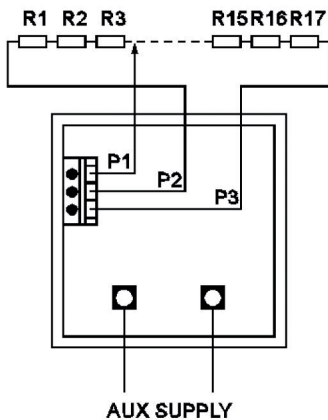

DIMENSIONS		
Description	M244	M246
<b>Bezel (mm)</b>	96	144
<b>Panel cut out (mm)</b>	92 (+0.8)	138 (+1.0)
<b>Bezel height (mm)</b>	5.5	8.0
<b>Terminal over (mm)</b>	90	90

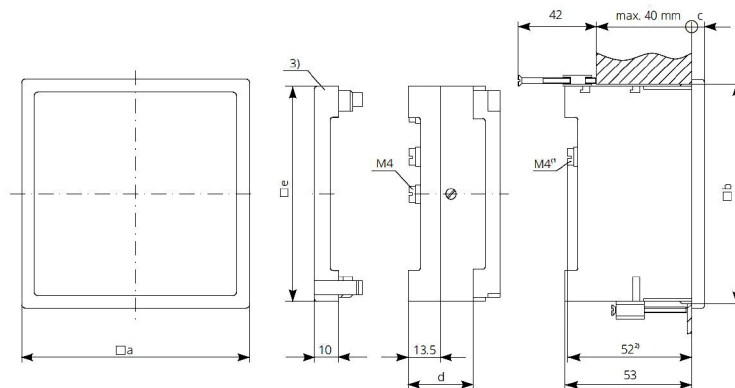

TE Connectivity Ltd. is a \$14 billion global technology and manufacturing leader creating a safer, sustainable, productive, and connected future. For more than 75 years, our connectivity and sensor solutions, proven in the harshest environments, have enabled advancements in transportation, industrial applications, medical technology, energy, data communications, and the home. With 80,000 employees, including more than 8,000 engineers, working alongside customers in approximately 140 countries, TE ensures that EVERY CONNECTION COUNTS. Learn more at [www.te.com](http://www.te.com) and on [LinkedIn](#), [Facebook](#), [WeChat](#) and [Twitter](#).

#### Generation

- Conventional Power
- Nuclear Power
- Wind/Solar
- Hydro-electric

#### Transmission & Distribution

- Substation
- Underground
- Overhead
- Street Lighting

#### Industry

- Mining
- Petrochemical
- Railway
- Shipbuilding

WHEREVER ELECTRICITY FLOWS, YOU'LL FIND TE ENERGY



[te.com/energy](http://te.com/energy)

#### FOR MORE INFORMATION: TE Technical Support Centres

USA: +1 800 327 6996  
UK: +44 1376 509 401  
Australia: +61 1300 656 090  
Singapore: +65 6590 5151  
Hong Kong: +852 2790 9609

[crompton-instruments.com](http://crompton-instruments.com)

© 2018 TE Connectivity Ltd. family of companies. All Rights Reserved. EPP-3337-4/19

TE Connectivity, the TE connectivity (logo) and Crompton Instruments are trademarks of the TE Connectivity Ltd. family of companies. Other logos, product and Company names mentioned herein may be trademarks of their respective owners. While TE has made every reasonable effort to ensure the accuracy of the information in this brochure, TE does not guarantee that it is error-free, nor does TE make any other representation, warranty or guarantee that the information is accurate, correct, reliable or current. TE reserves the right to make any adjustments to the information contained herein at any time without notice. TE expressly disclaims all implied warranties regarding the information contained herein, including, but not limited to, any implied warranties of merchantability or fitness for a particular purpose. The dimensions in this brochure are for reference purposes only and are subject to change without notice. Specifications are subject to change without notice. Consult TE for the latest dimensions and design specifications.