



## **BATTERY ENERGY STORAGE SYSTEMS (BESS)**

---

More Reliable Connectivity for a Dependable Grid

---

A man with a beard and short dark hair, wearing a light green sweater, is leaning forward and looking intently at a model of several white wind turbines. The background is a bright, slightly blurred indoor setting with a window and a plant.

# LET'S CREATE THE CONNECTIONS THAT COUNT.

TE Connectivity (NYSE: TE L) is a \$13 billion world leader in connectivity. The company designs and manufactures products at the heart of electronic connections for the world's leading industries, including automotive, energy and industrial, broadband communications, consumer devices, healthcare, and aerospace and defense. TE Connectivity's long-standing commitment to innovation and engineering excellence helps its customers solve the needs for more energy efficiency, always-on communications, and ever-increasing productivity. With nearly 90,000 employees in over 50 countries, TE Connectivity makes connections the world relies on to work flawlessly every day.

**To connect with the company, visit [te.com](https://te.com).**

# SMART TECHNOLOGY FOR TODAY AND TOMORROW.

More Streamlined, Efficient, and Resilient Connection Systems for Renewable Energy Sources

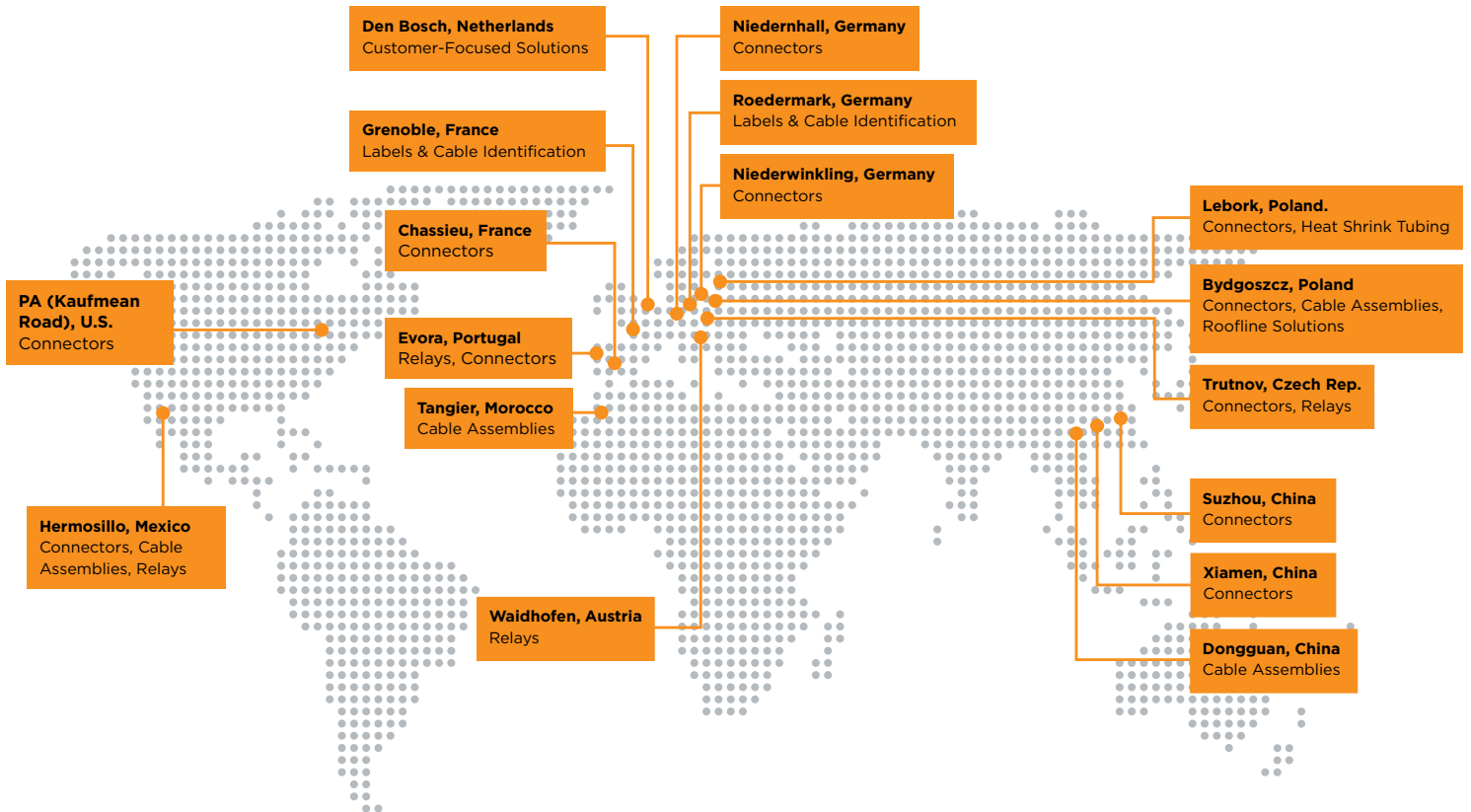

TE Connectivity worldwide — our production sites

As a global technical leader in connectors and sensors, TE Connectivity (TE) offers the products and integrated solutions that are precisely engineered to meet the strictest requirements of customers in terms of quality and performance excellence. For more than 60 years, we have maintained a partnership with the leading companies in major markets, such as Germany, Japan, the United States, and China.

TE provides customers with high-quality innovative solutions and fast, reliable services in the fields of automation and control, railways, and intelligent buildings. TE offers products that have demonstrated their superior performances in harsh environments, such as high pressure, vibrations, humidity, and high/low voltage.

With the arrival of Industry 4.0, TE plays a key role in the next level of industrial production and is committed to achieving win-win results with customers.

With TE as an innovative partner, you will find virtually everything you need to create and run a highly cost-effective and reliable production process. We connect materials to final products with smarter, faster, and better technology to cover virtually all the areas of life. To help ensure each solution is optimized, TE actively rises to every challenge.

Visit [TE.com](https://www.te.com) to call, live chat, or email a product specialist today about your vision and connectivity needs.

# THE FUTURE OF RENEWABLE ENERGY RELIES ON STORAGE CAPABILITIES.

## Stabilizing the Power Flow To Ensure Consistent Energy

Renewable energy options — solar and wind power — have become the focus of the world’s energy strategies. These sources have many advantages, including low carbon footprint, high efficiency, and broad interconnectivity. But there is one obstacle that has always impeded renewable energy efforts — consistency. The sun does not always shine and the wind does not always blow.

Because of this, energy storage has become essential to the future of renewable energy. The ability to house and distribute consistent, reliable power to consumers is key and serves two primary purposes:

### 1. TO STABILIZE THE GRID

Different power sources and loads being added to the grid can cause fluctuations in power. But having stored power available short-term can help balance out those inconsistencies.

### 2. TO COMPENSATE FOR TIMES OF LOW PRODUCTION

On cloudy days or still days, energy that has been stored in batteries can be drawn to stabilize the power flow, ensuring consistent access to energy.

With battery storage technology improving and driving down the cost of battery production, renewable energy production is increasing on a global scale. Energy leaders hope that by 2030 there will be a greener, smarter, and more interconnected energy scenario that integrates critical technologies — such as new energy power generation, demand-side integration, and energy storage — with smart equipment based on the Industrial Internet of Things (IIoT), new energy technologies, and smart power grids.

TE is focused on technology upgrades in the renewable energy industry and a complete flow of connection application solutions from power generation and energy storage to charging. We also provide customized connection solutions for charging stations, high-voltage control cabinets, and energy-storage and communication power supplies. At TE, we are dedicated to providing you with professional, efficient, economic, and differentiated services for a superior customer experience.

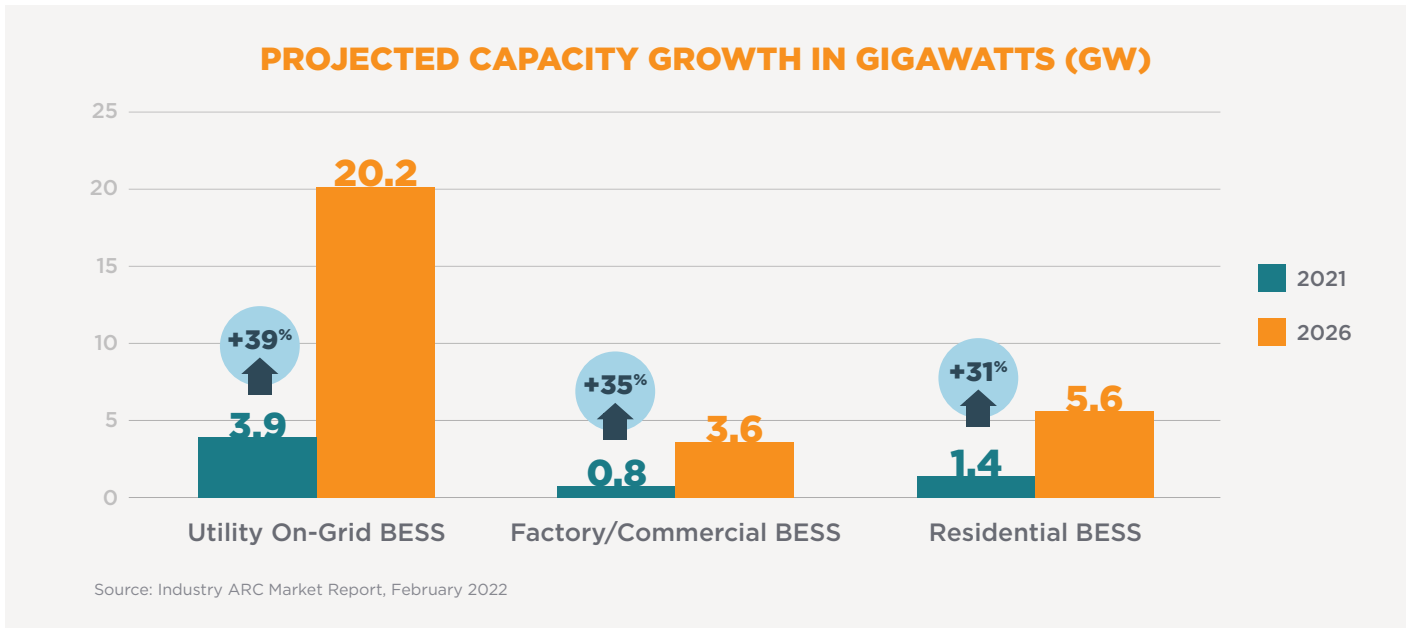

# BESS MARKET DRIVERS

## UTILITY ON-GRID BESS

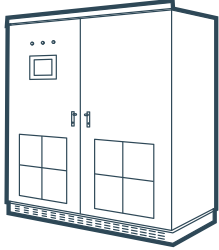

- The United States is undergoing significant structural changes, which will add an additional 10GW to the grid between 2021 and 2023 – 10 times the capacity than in 2019.
- China targets an increase in BESS installation capacity from 3.3GW in 2020 to >30GW by 2025.
- The Europe energy storage market is expected to reach 5.2GW of installed capacity in 2027 from 1.6GW in 2020.

## FACTORY/COMMERCIAL BESS

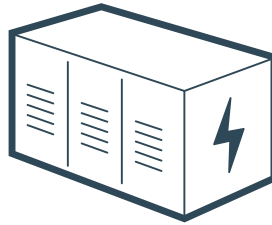

- Demand for backup power increases during outages for 5G centers, data centers, and hospitals.
- China announces time-of-use bill management that motivates companies to consider power storage during valley power pricing.
- Lithium-ion batteries are becoming less expensive, which reduces installation costs.

## RESIDENTIAL BESS

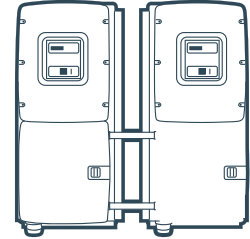

- U.S. and EMEA policies are pushing for residential energy storage projects <10kW.
- Reduced lithium-ion battery price is leading to more capacity and is fueling system adoption.
- Homeowners are increasing solar consumption – even selling power back to utilities during high-rate periods – by charging during the day and discharging at night, managing time-of-use rates, and providing backup power.

## TECHNOLOGY NEEDS AND TE SOLUTIONS

### WHAT YOU NEED

### WHY YOU NEED IT

### HOW TE CAN HELP

#### Increased Battery Cell Capacity

Increasing battery cell capacity allows you to improve power density and reduce the overall size of battery racks.

Large-capacity battery cells require greater battery consistency, a more precise battery management system (BMS) for heat dissipation, and thermal management. TE offers highly reliable connectors in small sizes.

#### Increased BESS Station Voltage

BESS stations are increasingly using 1500V DC instead of 1000V to improve power density and system efficiency and reduce installation costs.

The need to upgrade intelligent high voltage (IHV) to 1500V/400A to meet system voltage requirements means the BMS for battery racks must also resist 1500V. TE Dynamic Series connector solutions range from signal circuitry to power circuit connectivity, all in a rugged, industrialized package.

#### Shorter Design Cycle

Spec configurations in key subsystems are constantly upgrading. For example, a BMS can vary significantly from company to company and require short design cycles (<1.5 years).

TE's new product cadence is designed to keep up with customers' design cycles and product roadmaps. The TE team closely communicates with customers to understand your technology trends and help you prepare for next-generation products.

# TE PROVIDES INDUSTRY-LEADING CONNECTIVITY SOLUTIONS.

## More Than 60 Years of Experience in the Energy Industry

TE helps you improve power allocation flexibility in various phases of the energy landscape, from power generation to power transmission and consumption.

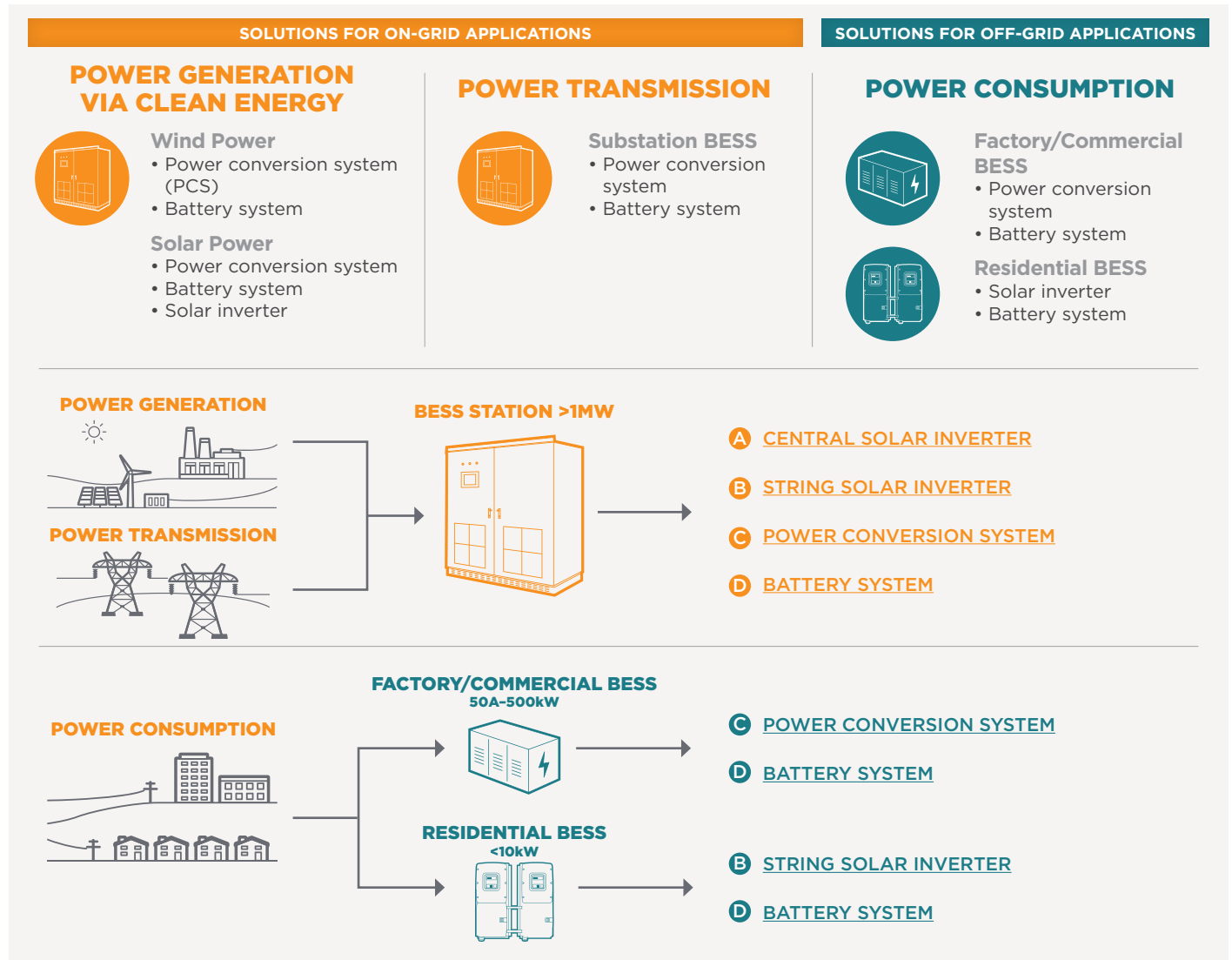

## TE IS YOUR GO-TO ENGINEERING PARTNER.

TE's high-quality, field-tested products are engineered specifically for the energy industry, so they are durable enough to tackle harsh environments as well as humidity, temperatures, and corrosion. When you partner with TE, you can expect to:

- Gain efficiency with one single partner for your multiple connectivity and sensor needs.
- Trust in our safer, more reliable, high-performing solutions that are designed to meet the many requirements of operating in hazardous environments.
- Consult with TE experts and a network of authorized distributors to support you wherever you are located and help you select the right solutions.
- Collaborate with our engineering team to create custom solutions and leverage our thousands of patents.

# APPLICATION SOLUTIONS FOR BESS

**CENTRAL SOLAR INVERTER**

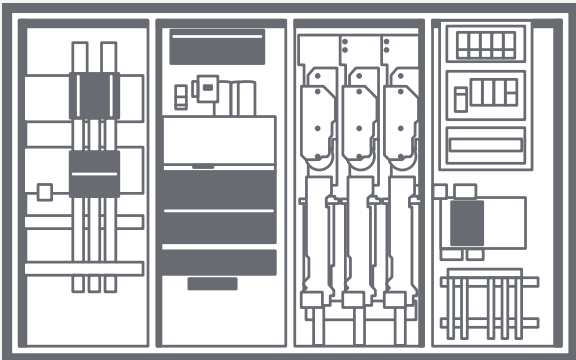

**STRING SOLAR INVERTER**

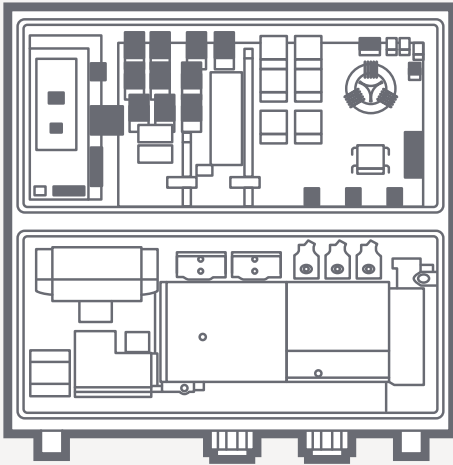

**POWER CONVERSION SYSTEM (PCS)**

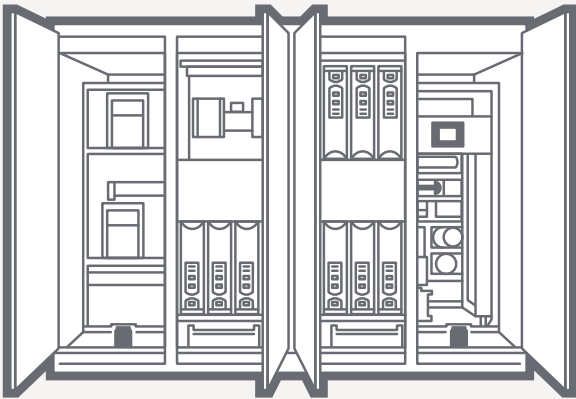

**BATTERY SYSTEM**

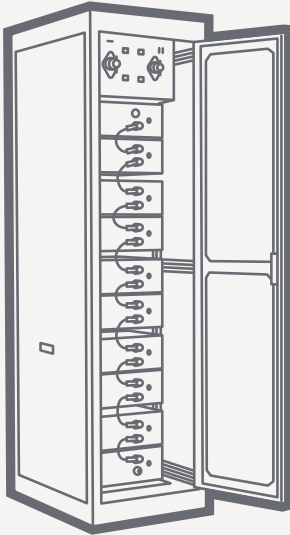

# CENTRAL SOLAR INVERTER

Central solar inverters are used to convert DC power from solar panels into AC power so it can be used by homes or businesses or connected to the grid. These inverters are typically floor- or ground-mounted, as opposed to string inverters that are installed on a wall or other structure. As inverters get bigger, manufacturers are looking for new innovations — cutting costs, creating smart grid features, standardizing monitoring and control interfaces — to maximize efficiencies and improve reliability. TE supports next-generation products with high-quality, reliable components that help save space without sacrificing power, including off-board power resistors, terminal blocks, and DC contactors.

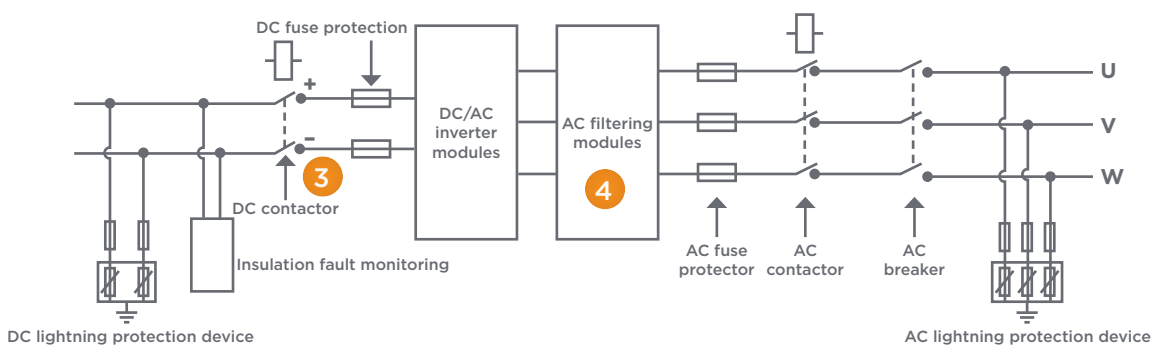
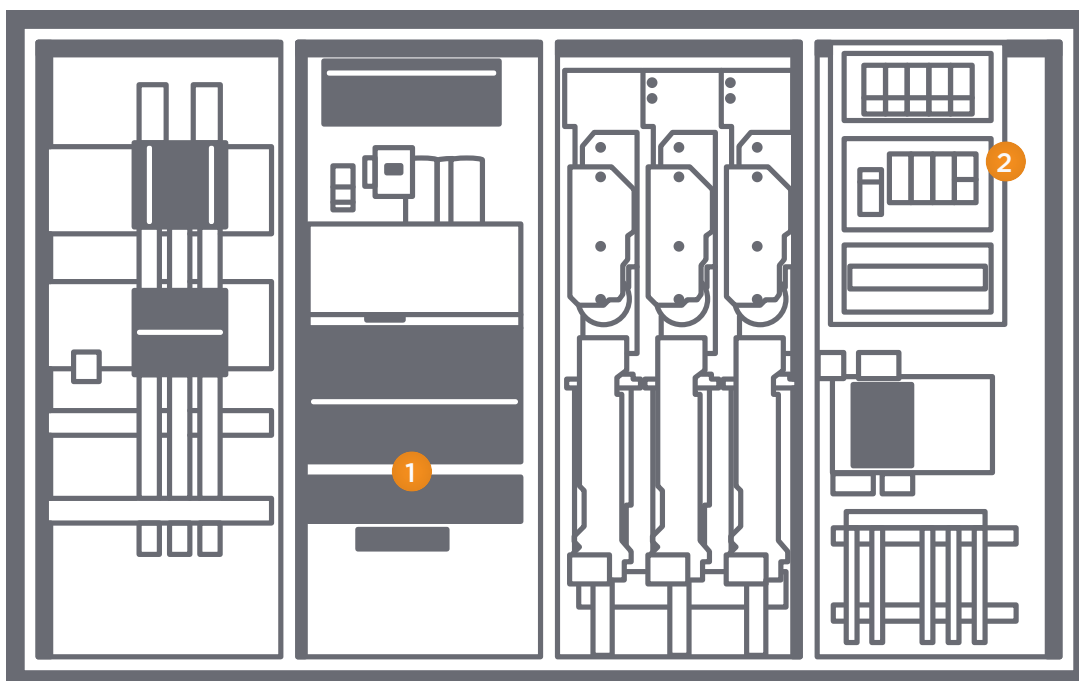

Configuration of 500kW Central Solar Inverter

- 1** Off-Board Power Resistors
- 2** Terminal Blocks
- 3** Main DC Contactor
- 4** EMI Filter



## OFF-BOARD POWER RESISTORS



The power resistor is widely used in railways, vehicles, and industrial sectors, as well as in various power applications (pre-charge, discharge, brake, etc.). This mature TE product offers extensive range and customizability.

### BENEFITS:

- Among the leading suppliers of standard and custom-designed, aluminum-housed resistors
- Stable, high-quality, wire-wound resistors capable of dissipating high power in a limited space with low surface temperature
- High-quality resistors designed for excellent reliability and stability

#### TE featured products:

**HS Series** and **CJH Series**

## TERMINAL BLOCKS



Terminal blocks are insulated connections that fasten two or more wires together and have an insulating frame and a clamping system. When you need reliable connection in hazardous environments, turn to TE's broad portfolio of terminal blocks.

### BENEFITS:

- Three configurations in one product: single pole and multipole splitter, plus a grouping for solar
- Connect round or flat conductors and take up only 50% of the space of copper bars
- Reduce assembly time by 80% since no additional fastening or isolating components are needed

#### TE featured products:

**ENTRELEC DBL Power Distribution Blocks**, **SNK Series screw-clamp terminal blocks**, and **plug-in and spring terminal blocks**

## MAIN DC CONTACTORS



The IHV and ECK main DC contactors from TE are designed for power distribution, main switch function, and unit control in BESS applications.

### BENEFITS:

- Full portfolio with rated current 50A–350A
- Hermetically sealed
- Auxiliary contact monitoring
- Maximum breaking voltage 900V DC for IHV and 1000V DC for ECK products
- Low power consumption with economizer

#### TE featured products:

**IHV100**, **IHV200**, **IHV350**, **ECK150**, **ECK200**, and **ECK250**

## CORCOM EMI FILTER



The Corcom EMI filter line offers a wide range of single- and 3-phase EMI filters for various industrial applications, including solar inverters, frequency conversion, power conversion, battery energy storage system, and many more.

### BENEFITS:

- Specifically developed for switching power supplies (Corcom EMI Filter)
- High attenuation for common and differential mode interference (Corcom EMI Filter)
- Reduces unwanted EMI noise within the conducted area (Corcom 3-Phase Power Filters)
- Rated from 3A to 1600A

### TE featured products:

**Q Series, EMC Series, AHV, KEM, KEH, KEP, KEV, APH, and APS Series**

## EXPERT SPOTLIGHT



### Brian Lineberry

Brian is a senior field application engineer on the industrial relays team, training customers about TE's broad portfolio of general-purpose relays.

He began his nearly 35-year career as a test technician working in the quality department. Much of Brian's efforts have focused on helping to create industry standards for relay manufacturers. Brian has represented TE on industry standards development committees for the UL, NEMA, CANENA, and IEC.

[Connect with our product expert ▶](#)

# STRING SOLAR INVERTERS

String solar inverters are an essential part of solar panel systems because they aggregate the power output of solar panels into “strings.” These strings are connected to a single inverter where electricity is converted from DC to AC so it can be used in homes or businesses or connected to the grid.

String inverters are continually evolving — newer systems have advanced features that are compatible with smart grids. In addition, sensors and monitoring tools are being used to enhance string inverters into energy management centers. TE supports the string solar inverter market with highly dependable yet compact and powerful products such as signal relays, electromagnetic interference (EMI) filters, passive resistors, and power relays.

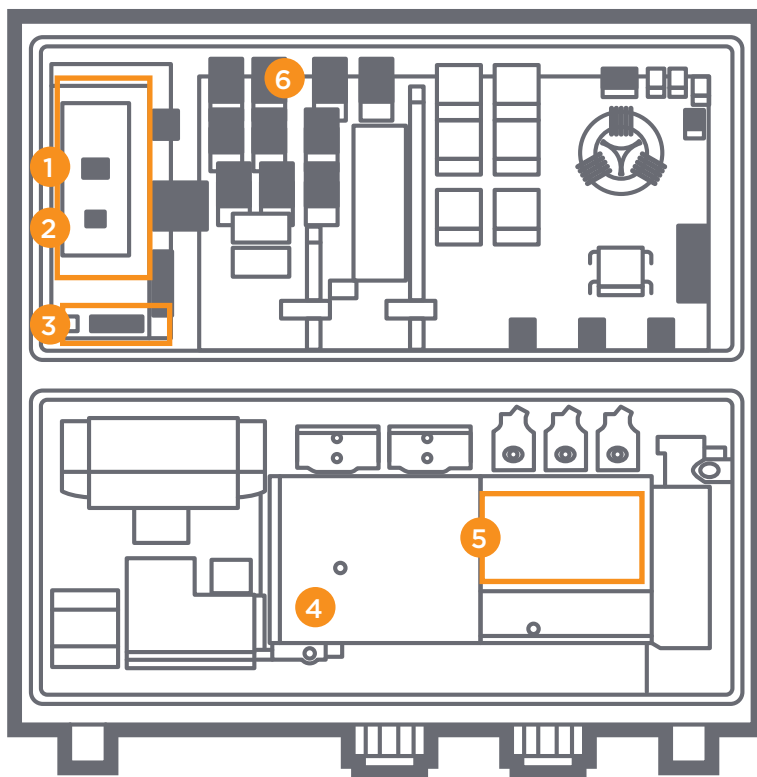

- 1 Signal Relays (IM, P2)
- 2 DC EMI Filter
- 3 Board Signal (Micro-MaTch, SMC)
- 4 Passive Resistors (CPF, SQ)
- 5 Corcom EMI Filter
- 6 Power Relay (T9S, PCFN, OJS)

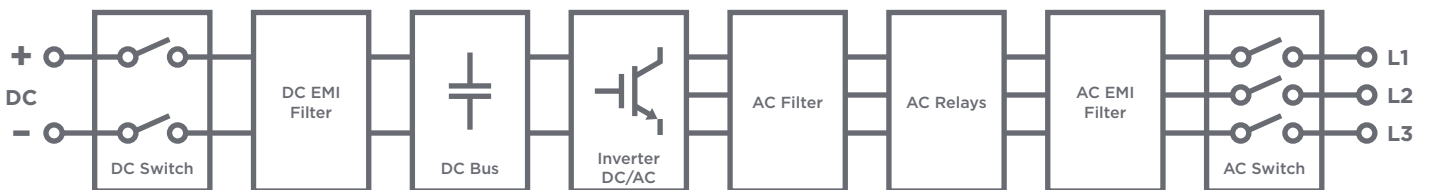

*Configuration of 125kW String Solar Inverter*

## SIGNAL RELAYS

## DC EMI FILTERS

## BOARD SIGNAL

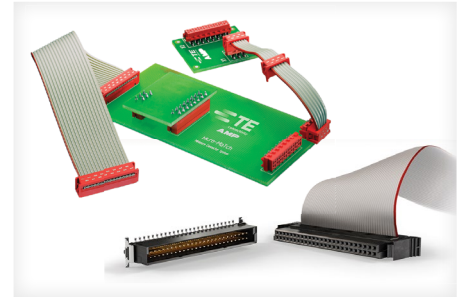
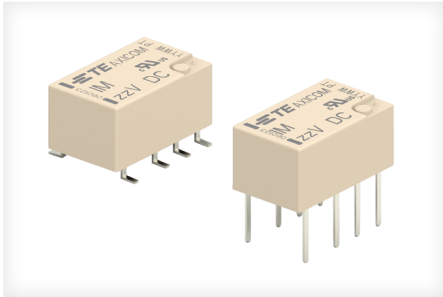

Smaller-sized IM and P2 series signal relays enable space savings, and their low power consumption offers energy-saving solutions in the new energy market.

### BENEFITS:

- Small size saves space
- Switching current 2A/5A, switching power 60W/62.5VA, and switching voltage 220V DC/250V AC
- Low coil power consumption that saves energy
- High dielectric and surge capability up to 2500Vrms between open contacts and 2500Vrms between coil and contacts

### TE featured products:

**Axicom IM** and **Axicom P2**

Corcom DC EMI filters are available to help address everything from simple EMI-RFI issues to high-frequency noise problems encountered with high-speed data transmission and switching power supplies.

### BENEFITS:

- Medium- and multiple-stage, high-performance DC power line filters
- High-frequency DC power line filters (up to 3GHz)
- High-current DC power line filters (up to 60A)
- Compact design saves space

### TE featured products:

**DB Series** and **DC Series**

TE's board signals are designed to help reduce signal loss during high vibration and shock for board-to-board and cable signal connections to the printed circuit board (PCB).

### BENEFITS:

- Contact design for high vibration tolerance helps reduce fretting corrosion
- Contact design allows for tin plating, driving cost savings
- Easy to apply with flat cable IDC termination
- UL approval on materials, the connector, and the cable assemblies
- Also available as case assemblies

### TE featured products:

**Micro-MaTch** and **ERNI SMC**

## PASSIVE RESISTORS



The power resistor is widely used in PCB and cabinets for current limitation, voltage division, and circuit protection. TE provides a wide resistor portfolio for the BESS market.

### BENEFITS:

- Extensive variety of surface mount resistors and devices, including resistors suitable for pulse, surge, and voltage applications
- Standard thick-film surface-mount resistors that offer power ratings up to 6W, wire-wound molded resistors up to 7W, and ceramic-housed resistors up to 40W
- Small SMD power resistors that take up less space than traditional leaded products and offer a range of SMD thin-film resistors with both NiCr and TaN film technology

### TE featured products:

SMD/THT resistors

## CORCOM EMI FILTER



The Corcom EMI filter line offers a wide range of single- and 3-phase EMI filters for various industrial applications, including solar inverters, frequency conversion, power conversion, battery energy storage system, and many more.

### BENEFITS:

- Specifically developed for switching power supplies (Corcom EMI Filter)
- High attenuation for common and differential mode interference (Corcom EMI Filter)
- Reduces unwanted EMI noise within the conducted area (Corcom 3-Phase Power Filters)
- Rated from 3A to 1600A

### TE featured products:

Q Series, EMC Series, AHV, KEM, KEH, KEP, KEV, APH, and APS Series

## POWER RELAYS



TE's T9S and PCFN power relay series are designed for the solar inverter market with big contact spacing, which enables high dielectric strength and reliability. The OJS series offers a space-saving switching solution for the new energy market.

### BENEFITS:

- High-current switching up to 40A
- High dielectric strength with big contact spacing
- Low temperature rise and a maximum operating temperature of 85°C
- Certified by UL/VDE/TUV laboratory

### TE featured products:

T9S, PCFN, and OJS

# POWER CONVERSION SYSTEM (PCS)

A PCS is the critical device that allows a battery system to convert DC stored energy into AC transmissible energy. The PCS also controls the charging and discharging process of the battery and allows for the large-scale utilization of renewable energy sources, energy storage, and microgrids.

TE supports the PCS industry with industry-leading connectivity solutions, including DC contactors, pre-charge and off-board resistors, EMI filters, terminal blocks, and panel-plug-in (PPI) relays.



1 DC Contactors (IHV, ECK)

3 EMI Filters

5 PPI Relay

2 Pre-Charge Resistors/  
Off-Board Power Resistors

4 Terminal Blocks  
(DBL, SNK)

## MAIN DC CONTACTORS



The IHV and ECK main DC contactors from TE are designed for power distribution, main switch function, and unit control in BESS applications.

### BENEFITS:

- Full portfolio with rated current 50A-350A
- Hermetically sealed
- Auxiliary contact monitoring
- Maximum breaking voltage 900V DC for IHV and 1000V DC for ECK products
- Low power consumption with economizer

### TE featured products:

**IHV100, IHV200, IHV350, ECK150, ECK200, and ECK250**

## OFF-BOARD POWER RESISTORS



The power resistor is widely used in railways, vehicles, and industrial sectors, as well as in various power applications (pre-charge, discharge, brake, etc.). This mature TE product offers extensive range and customizability.

### BENEFITS:

- Among the leading suppliers of standard and custom-designed, aluminum-housed resistors
- Stable, high-quality, wire-wound resistors capable of dissipating high power in a limited space with low surface temperature
- High-quality resistors designed for excellent reliability and stability

### TE featured products:

**HS Series and CJH Series**

## CORCOM EMI FILTER



The Corcom EMI filter line offers a wide range of single- and 3-phase EMI filters for various industrial applications, including solar inverters, frequency conversion, power conversion, BESS, and many more.

### BENEFITS:

- Specifically developed for switching power supplies (Corcom EMI Filter)
- High attenuation for common and differential mode interference (Corcom EMI Filter)
- Reduces unwanted EMI noise within the conducted area (Corcom 3-Phase Power Filters)
- Rated from 3A to 1600A

### TE featured products:

**Q Series, EMC Series, AHV, KEM, KEH, KEP, KEV, APH, and APS Series**

## TERMINAL BLOCKS

## SCHRACK RELAY PPI

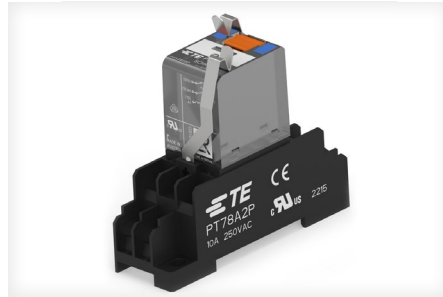

Terminal blocks are insulated connections that fasten two or more wires together and have an insulating frame and a clamping system. When you need reliable connection in hazardous environments, turn to TE's broad portfolio of terminal blocks.

### BENEFITS:

- Three configurations in one product: single pole and multipole splitter, plus a grouping for solar
- Connect round or flat conductors and take up only 50% of the space of copper bars
- Reduce assembly time by 80% because no additional fastening or isolating components are needed

### TE featured products:

**ENTRELEC DBL Power Distribution Blocks**, **SNK Series screw-clamp terminal blocks**, and **plug-in and spring terminal blocks**

TE's SCHRACK panel-plug-in relays and sockets offer a wide range of options in the control cabinet applications for the renewable energy market. Strong switching capability and stability enable high system reliability.

### BENEFITS:

- High reliability to carry high current
- Broad portfolio with relay and socket available
- Multiple mounting styles available
- White marking tabs

### TE featured products:

**PT Relay Socket** and **Miniature Relay PT**

## SALES SPOTLIGHT



“TE is a key supplier in the BESS market. We have an excellent footprint. We can give our customers a broader portfolio via our distributor channel — one supplier for their needs.”

— Marco Schadach,  
Sales manager,  
TE Connectivity

Connect with our product expert ▶



# BATTERY SYSTEMS

A battery system is a complete energy storage system that plays a key role in renewable energy success by helping to balance renewable energy supplies with electricity demands. As batteries are asked to do more — complete a higher number of duty cycles, last longer, and hold more power — manufacturers are working with new thermal management technologies.

TE supports next-generation battery systems with a broad portfolio of more reliable, compact, safer components, including switches, connectors, DC contactors, off-board power resistors, terminal blocks, and EMI filters.

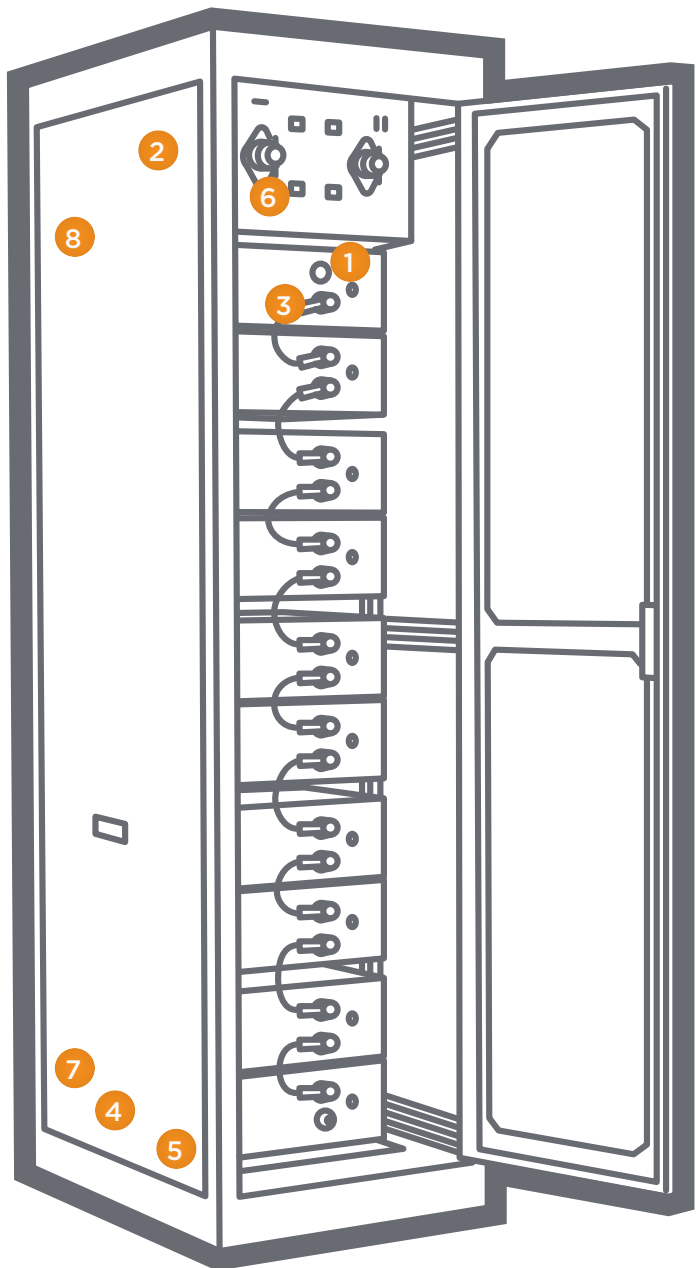

- 1 Switch
- 2 Board Connectors
- 3 Power Connectors
- 4 DC Contactors
- 5 Off-Board Power Resistors
- 6 Power & Signal Connectors
- 7 1-Phase EMI Filter
- 8 Terminal Blocks

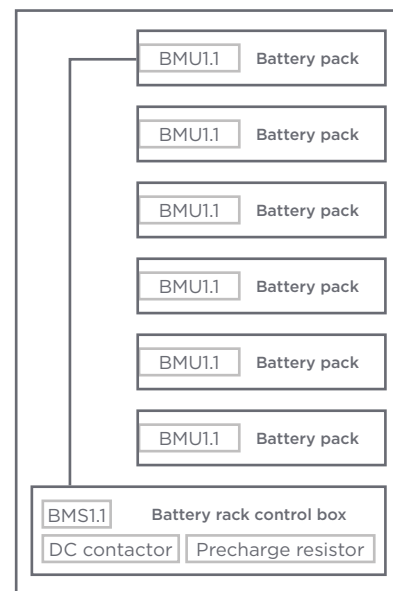

*Configuration of Battery Rack in Commercial/Factory BESS*

## SWITCHES



TE's robust design gives you highly reliable switches for energy applications. Manufactured with a stainless steel frame and actuator, TE switches combine mechanical strength and chemical resistance.

### BENEFITS:

- Robust functionality with more reliable performance
- Rugged protection against deliberate attempts to tamper with and/or damage the device
- LED indicators that illuminate the switch and provide an easier user interface

#### TE featured products:

**Anti-Vandal Switches** and **Emergency Stop Switches**

## BOARD CONNECTORS



TE's board connectors are specially tailored to provide wire-to-board signal and power connections in small spaces.

### BENEFITS:

- Rugged housing and high retention force design for rugged connectivity
- Large portfolio of position counts, voltage, and current ratings to enable wide usage and compact designs
- Safer choice thanks to the high-level, anti-flash housing material

#### TE featured products:

**Dynamic Mini Series, D1000 Series, D3000 Series, ERNI MaxiBridge Series, VolTron 1000 Connectors** ([contact TE for more details](#)), **ERNI SMC Series, ERNI MSP Power Series, ERNI Power Taps**, and **ERNI PowerElements**

## POWER CONNECTORS

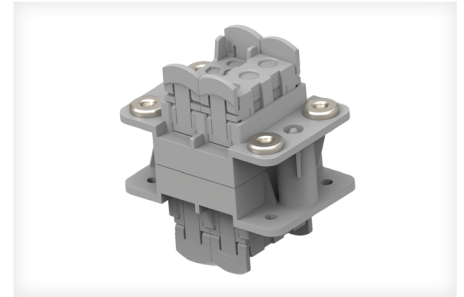

The rapid growth of liquid cooling solutions for BESS brings the need for higher performance and reliability requirements to power connection solutions.

### BENEFITS:

- Blind mating thermoplastic connector system that accepts standard HMN-modules for data, signal, and power
- Pre-leading pins and float washers to balance the mechanical tolerances of a drawer system
- Excellent design flexibility with a wide range of standardized components

#### TE featured products:

HPC Connectors, **HDC Connectors**, and **HVP 1100 Series**

## MAIN DC CONTACTORS



The IHV and ECK main DC contactors from TE are designed for power distribution, main switch function, and unit control in BESS applications.

### BENEFITS:

- Full portfolio with rated current 50A-350A
- Hermetically sealed
- Auxiliary contact monitoring
- Maximum breaking voltage 900V DC for IHV and 1000V DC for ECK products
- Low power consumption with economizer

### TE featured products:

**IHV100, IHV200, IHV350, ECK150, ECK200, and ECK250**

## OFF-BOARD POWER RESISTORS



The power resistor is widely used in railways, vehicles, and industrial sectors, as well as in various power applications (pre-charge, discharge, brake, etc.). This mature TE product offers extensive range and customizability.

### BENEFITS:

- Among the leading suppliers of standard and custom-designed, aluminum-housed resistors
- Stable, high-quality, wire-wound resistors capable of dissipating high power in a limited space with low surface temperature
- High-quality resistors designed for excellent reliability and stability

### TE featured products:

**HS Series and CJH Series**

## POWER & SIGNAL CONNECTORS



The increasing digitalization of BESS systems has increased the demand for reliable signal and data connection solutions.

### BENEFITS:

- Compact and cost-effective solution
- High level of performance
- Halogen-free product
- Rated voltage up to 500V with current up to 20A

### TE featured products:

**M8/M12 Signal Connectors, NGC Connector Series, and CPC Series 1-Sealed One-Piece NGC Connector Series**

## TERMINAL BLOCKS



Terminal blocks are insulated connections that fasten two or more wires together and have an insulating frame and a clamping system. When you need reliable connection in hazardous environments, turn to TE's broad portfolio of terminal blocks.

### BENEFITS:

- Three configurations in one product: single pole and multipole splitter, plus a grouping for solar
- Connect round or flat conductors and take up only 50% of the space of copper bars
- Reduce assembly time by 80% because no additional fastening or isolating components are needed

### TE featured products:

**ENTRELEC DBL Power Distribution Blocks, SNK Series Screw-Clamp Terminal Blocks, and Plug-in and Spring Terminal Blocks**

## CORCOM 1-PHASE EMI FILTERS



Single-Phase Corcom EMI filters are widely used in industrial applications, including frequency conversion, inversion, variable pitch system, and other filter circuits.

### BENEFITS:

- Specifically developed for switching power supplies
- High attenuation for common and differential mode interference
- Effective from 10kHz to 30MHz
- Available with a variety of terminal connection options

### TE featured products:

**Q Series and EMC Series**

## EXPERT SPOTLIGHT



### Takemasa Eiichiro

Meet Takemasa, a nearly 30-year TE engineering veteran who has spent most of his career focused on connectors. This inventor has applied for 15 patents. With the huge growth in renewable energy, Takemasa is watching trends like high current requests for connectors, increasing the flow capacity capability for connectors, and adding sensor technology within a connector.

[Connect with our product expert >](#)

## CONNECT WITH US.

Get Answers to Your Questions Now.

We make it easy to connect with our experts and are ready to provide the support you need, including:

- [Product information](#)
- [Product comparisons for your project](#)
- [Discussions with TE engineers and product experts](#)
- [Project consultations](#)
- [TE design resources and tools](#)

---

### te.com

©2023 TE Connectivity. All Rights Reserved.

TE Connectivity, TE, TE connectivity (logo), EVERY CONNECTION COUNTS, ERNI, SCHRACK, CORCOM, MICRO-MATCH and ENTRELEC are trademarks owned or licensed by TE Connectivity. All other logos, products and/or company names referred to herein might be trademarks of their respective owners.

The information given herein, including drawings, illustrations and schematics which are intended for illustration purposes only, is believed to be reliable. However, TE Connectivity makes no warranties as to its accuracy or completeness and disclaims any liability in connection with its use. TE Connectivity's obligations shall only be as set forth in TE Connectivity's Standard Terms and Conditions of Sale for this product and in no case will TE Connectivity be liable for any incidental, indirect or consequential damages arising out of the sale, resale, use or misuse of the product. Users of TE Connectivity products should make their own evaluation to determine the suitability of each such product for the specific application.

2RM 02/23

### BROCHURE

TE Connectivity  
1050 Westlakes Drive  
Berwyn, PA 19312  
Tel +1 610 893 9800