

LOC		DIST		REVISIONS			
GP	00	P	LTN	DESCRIPTION	DATE	OWN	APVD
				SEE SHEET 1			

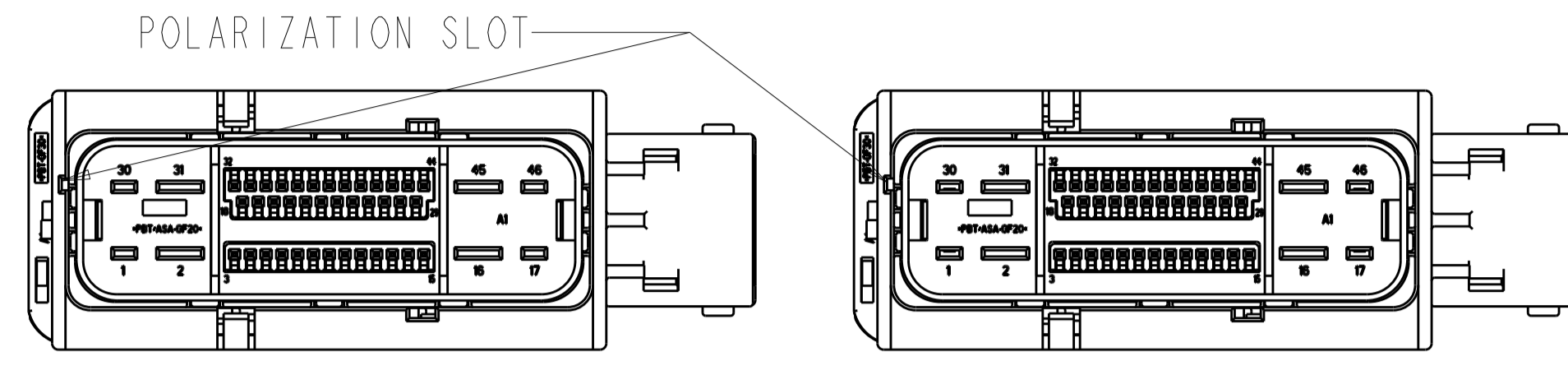

SCALE 1:1
 1326327-X
 RIGHT HAND WIRE EXIT,
 2.8 BLOCKED,
 SINGLE POLARIZATION SLOT
 A

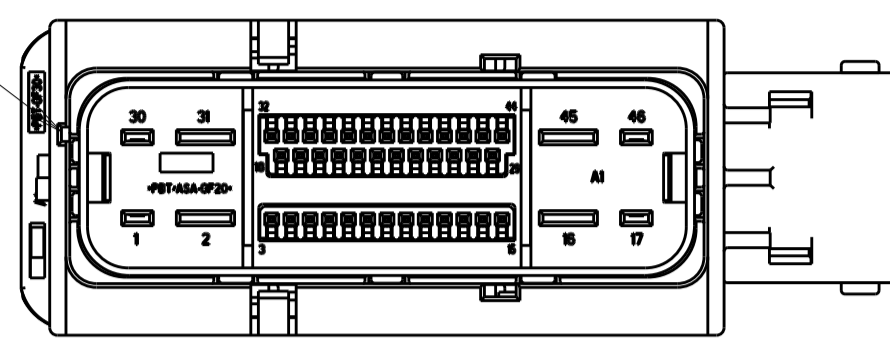

SCALE 1:1
 1326110-X
 RIGHT HAND WIRE EXIT,
 2.8 OPEN,
 SINGLE POLARIZATION SLOT
 B

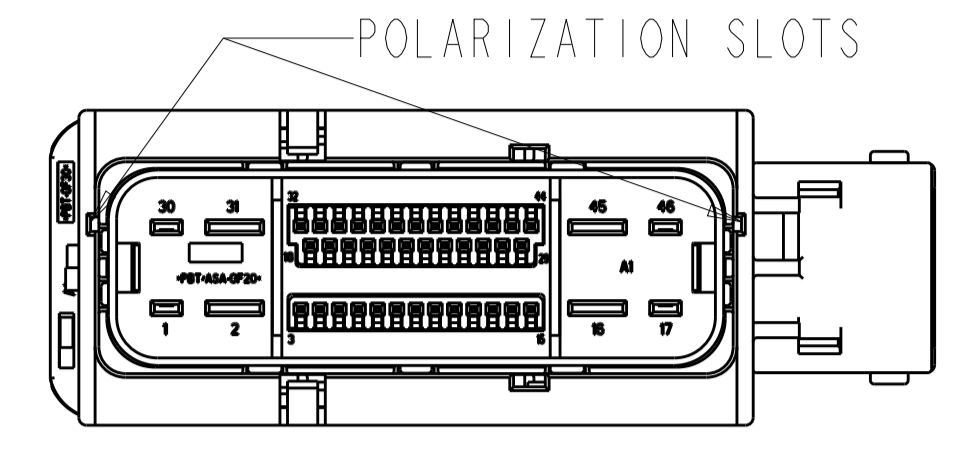

SCALE 1:1
 1326328-X
 RIGHT HAND WIRE EXIT,
 2.8 BLOCKED,
 DUAL POLARIZATION SLOTS
 C

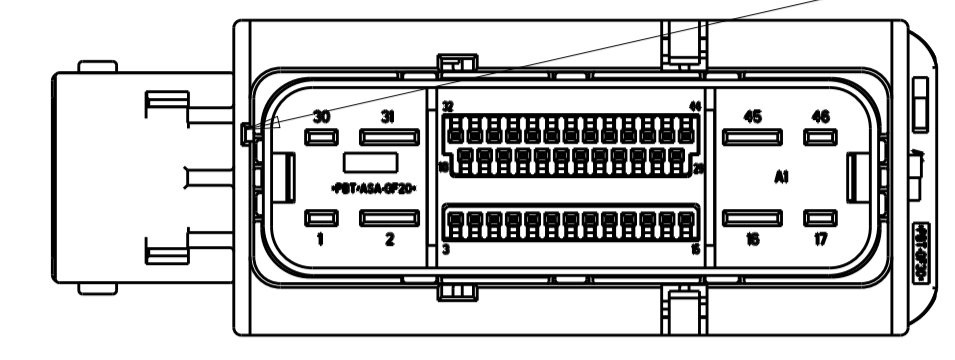

SCALE 1:1
 1326338-X
 LEFT HAND WIRE EXIT,
 2.8 BLOCKED,
 SINGLE POLARIZATION SLOT
 D

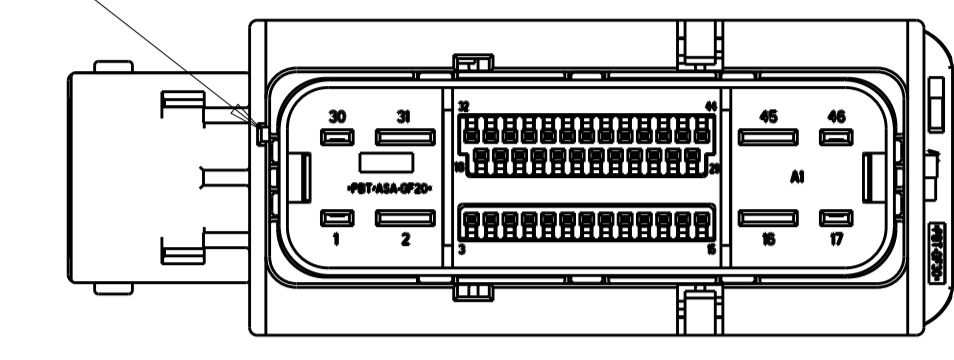

SCALE 1:1
 1326341-X
 LEFT HAND WIRE EXIT,
 2.8 OPEN,
 SINGLE POLARIZATION SLOT
 E

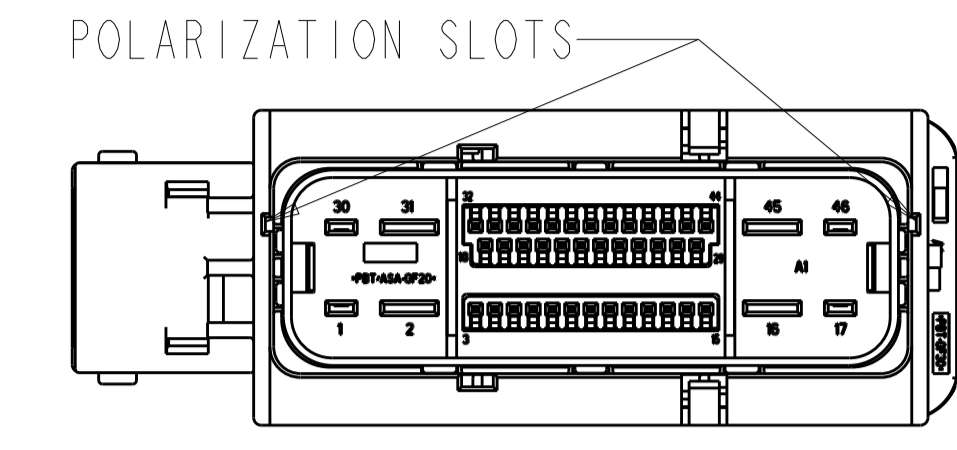

SCALE 1:1
 1326339-X
 LEFT HAND WIRE EXIT,
 2.8 BLOCKED,
 DUAL POLARIZATION SLOTS
 F

PINOUT CONFIGURATION GEOMETRY

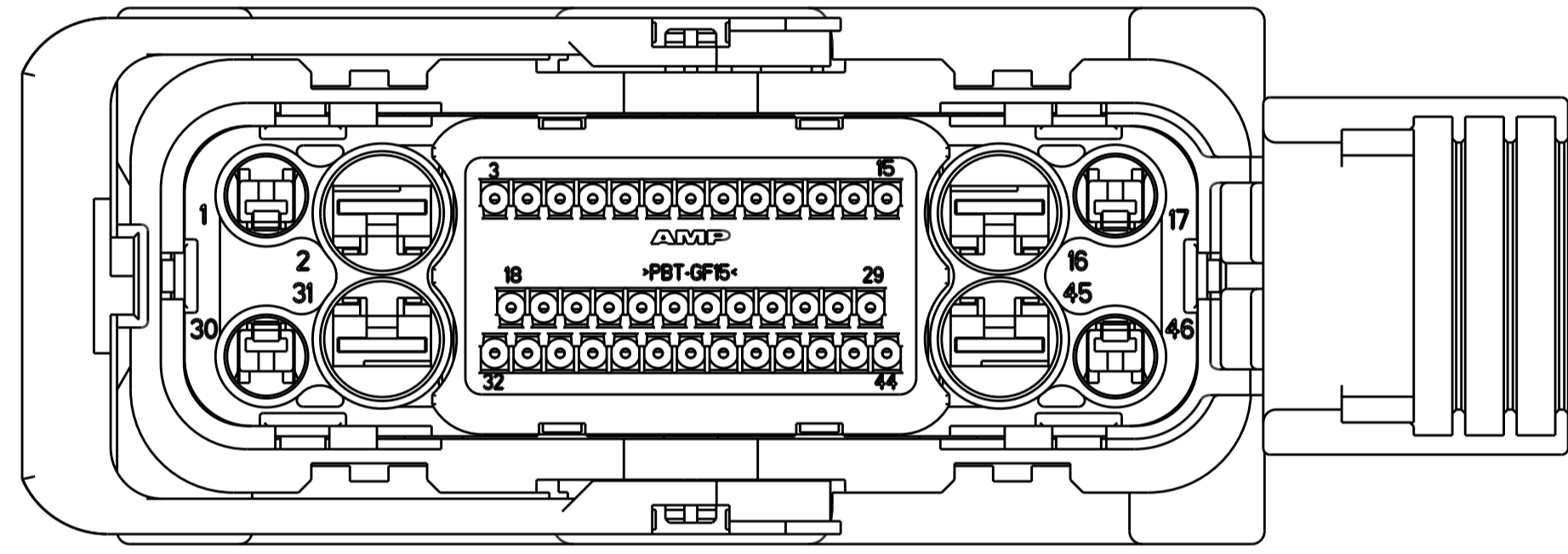

1326110-1
 SCALE 2:1

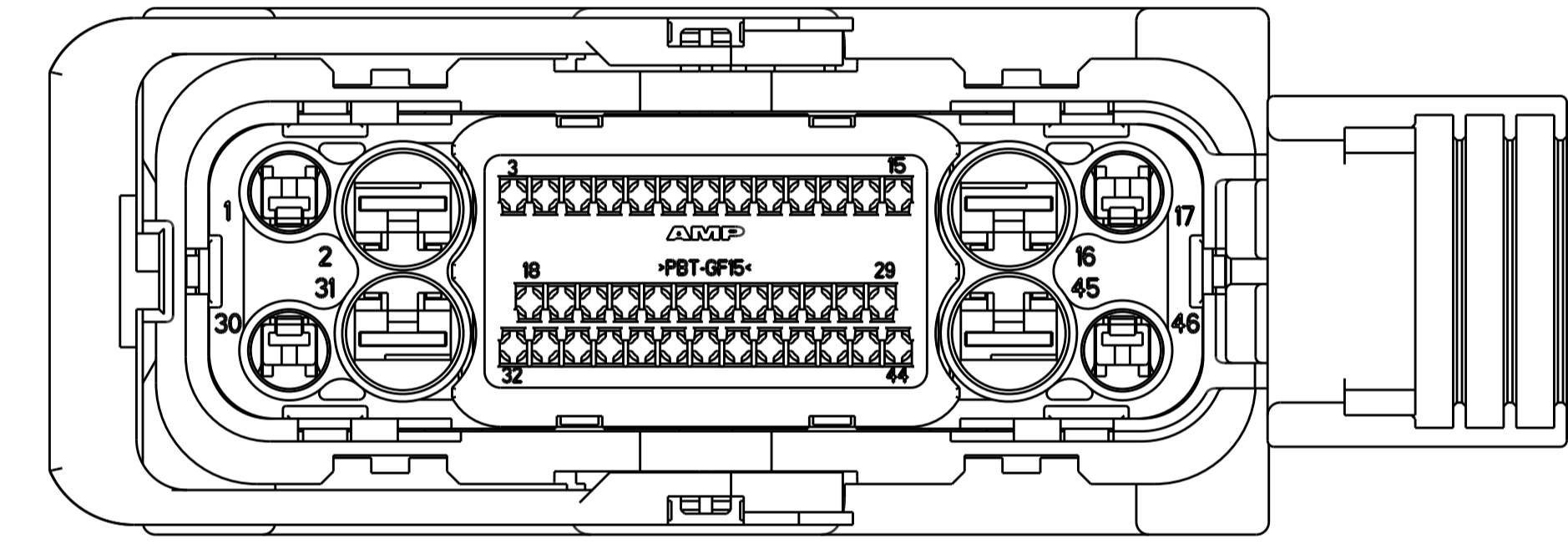

1326110-2
 SCALE 2:1

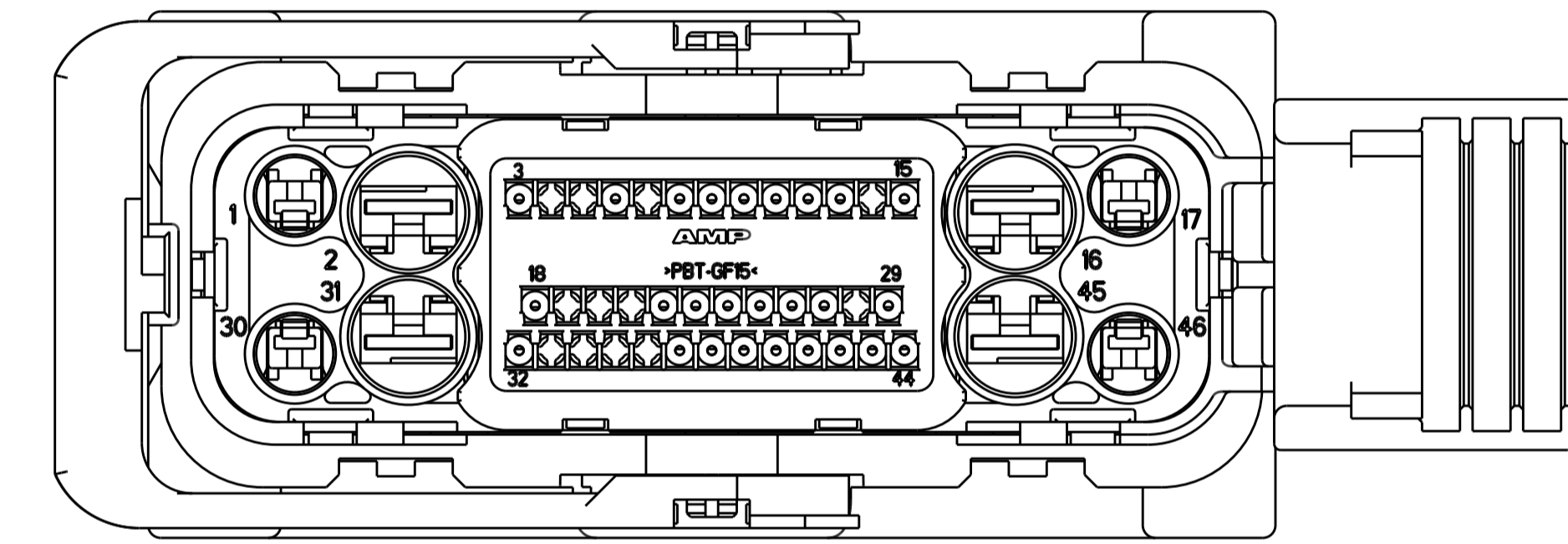

1326110-3
 SCALE 2:1

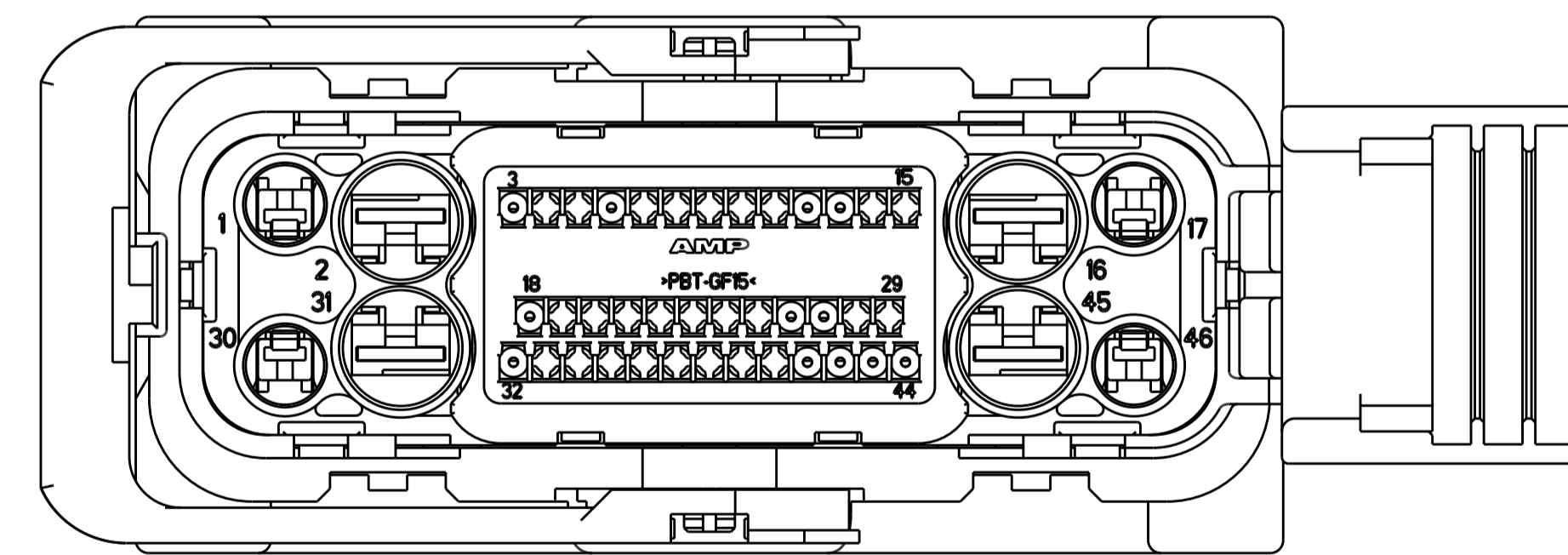

1326110-4
 SCALE 2:1

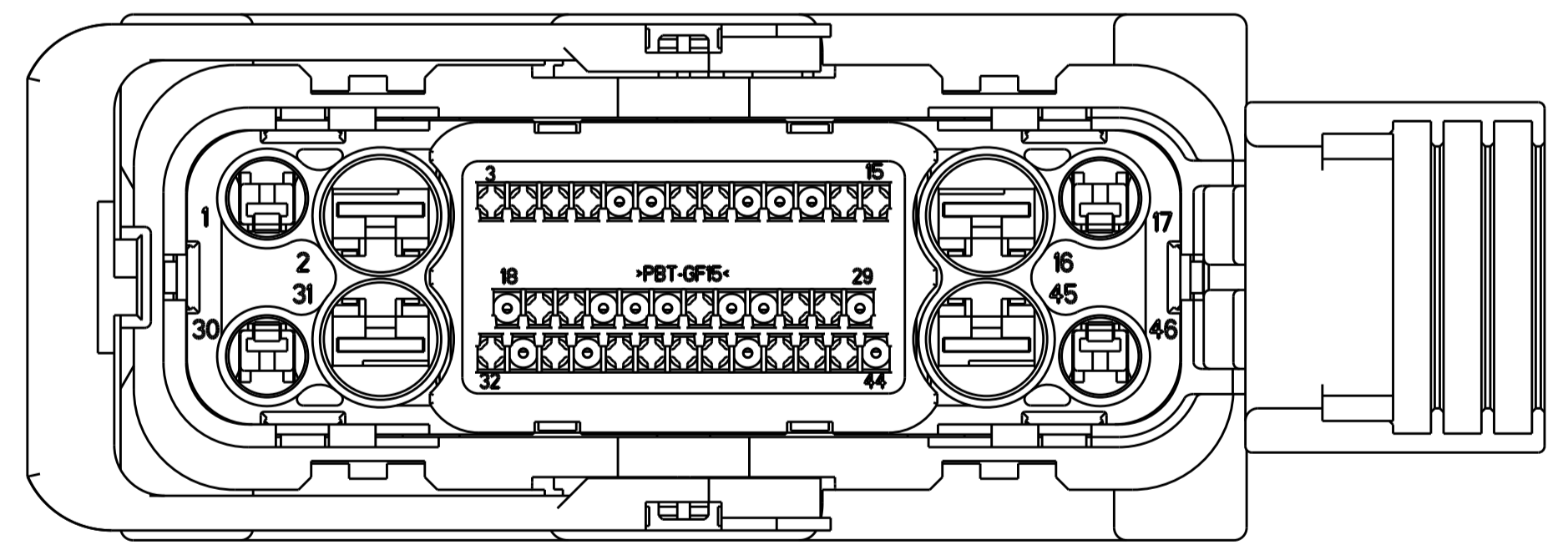

1-1326110-0
 SCALE 2:1

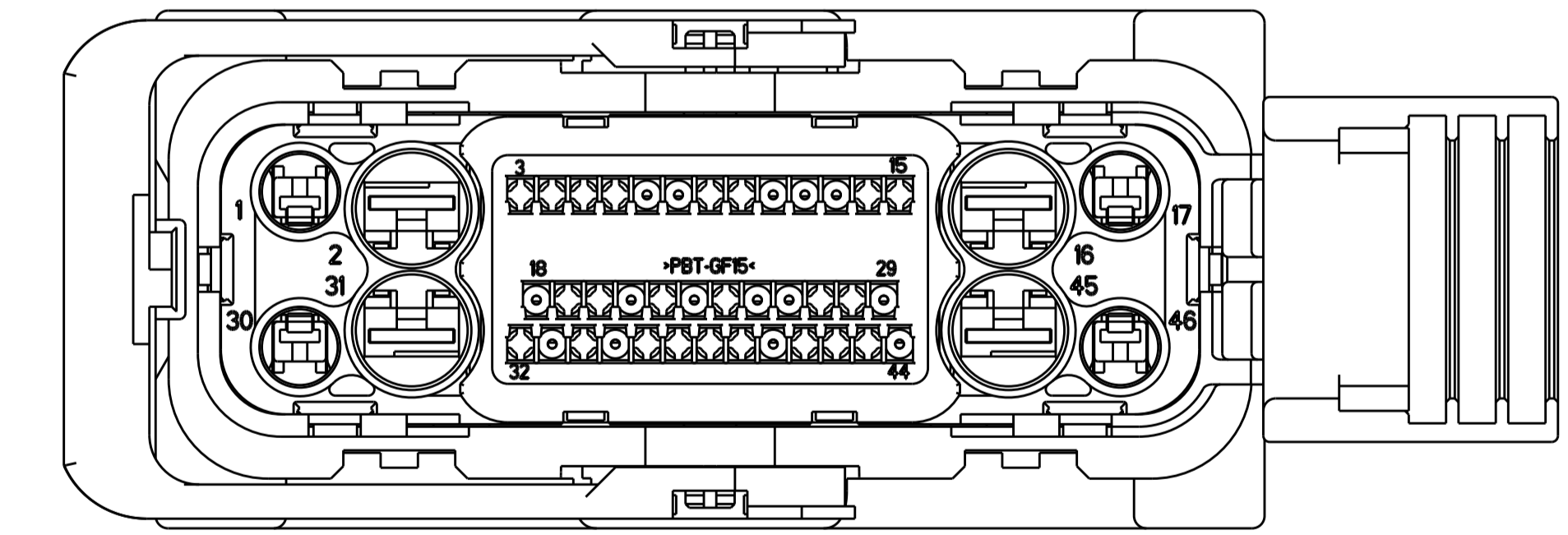

1-1326110-1
 SCALE 2:1

THIS DRAWING IS A CONTROLLED DOCUMENT.		OWN A. HOLT 01APR2003	TE Connectivity DRAWING MATRIX 46 POSITION EBC-440 PLUG ASSEMBLY
DIMENSIONS:		CHK J. TONEY 01APR2003	
mm	TOLERANCES UNLESS OTHERWISE SPECIFIED:	APVD J. TONEY 01APR2003	NAME
0 PLC ±	1 PLC ±	PRODUCT SPEC	SIZE
2 PLC ±	3 PLC ±	APPLICATION SPEC	CAGE CODE
4 PLC ±	ANGLES ±	WEIGHT	DRAWING NO
MATERIAL	FINISH	Customer Drawing	RESTRICTED TO
			A1 00779 ©=1326534
			SCALE NONE SHEET 3 OF 12 REV AF7

PINOUT CONFIGURATION GEOMETRY

LOC	DIST	REV	DATE	APPV
GP	00			

REVISIONS		DATE	OWN	APPV
1	SEE SHEET 1			

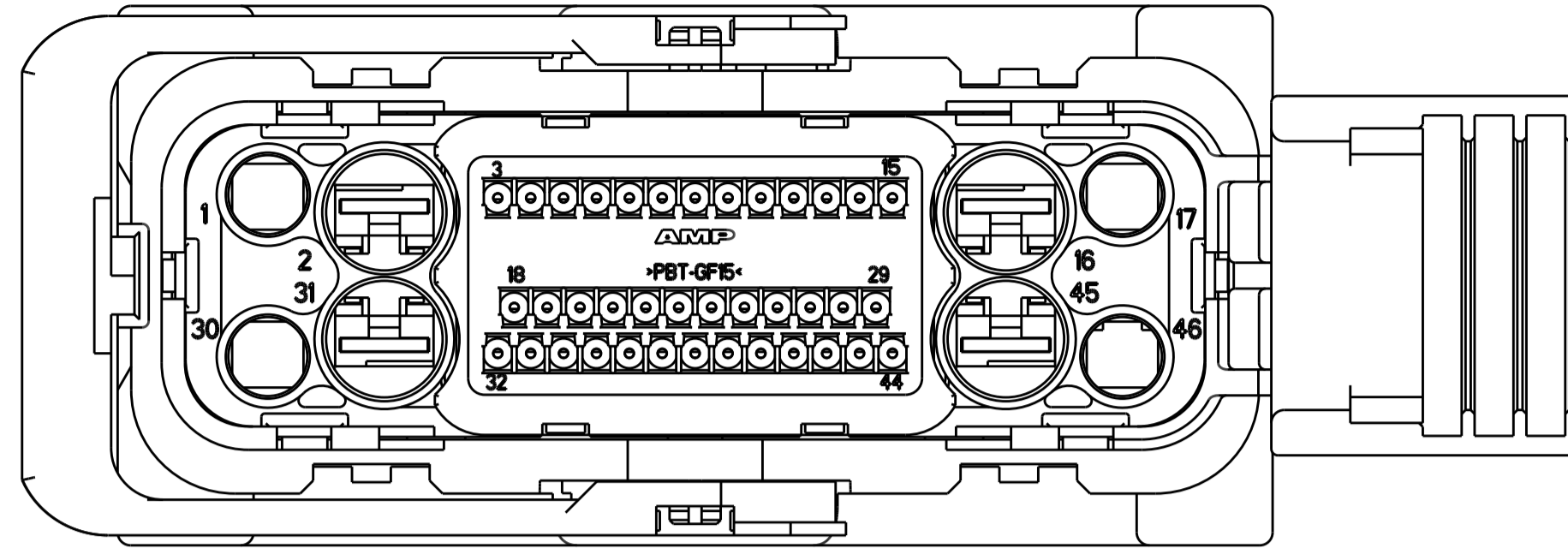

1326327-1
SCALE 2:1

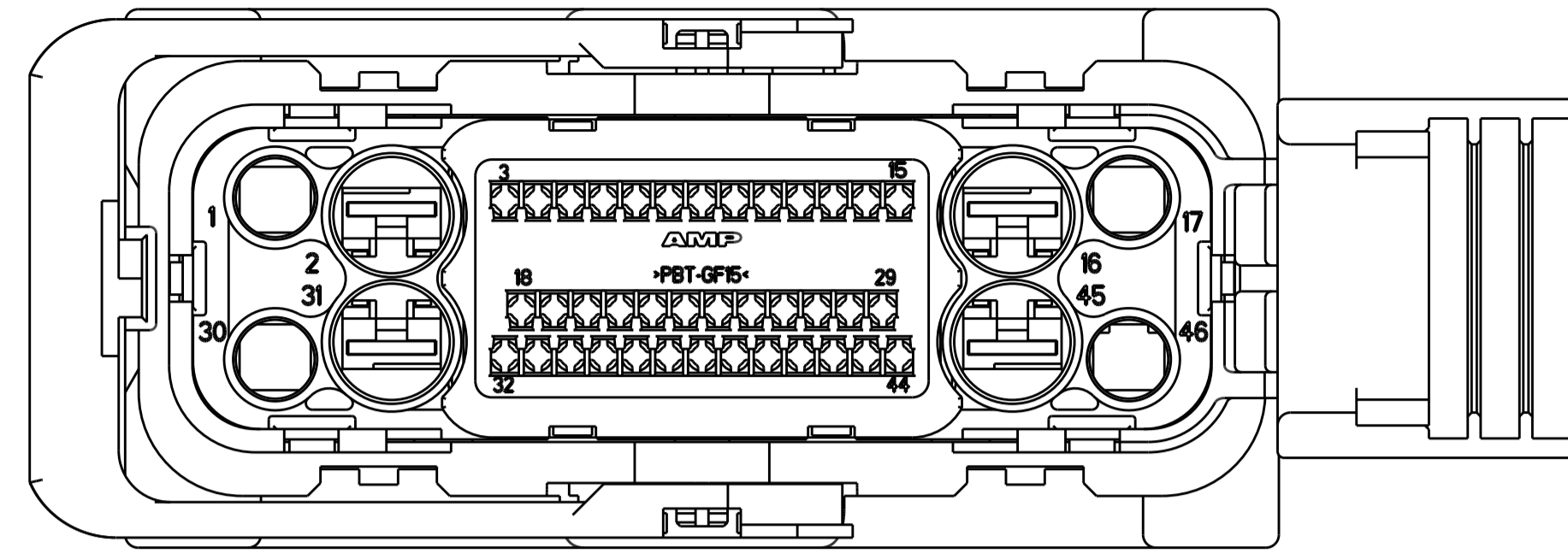

1326327-2
SCALE 2:1

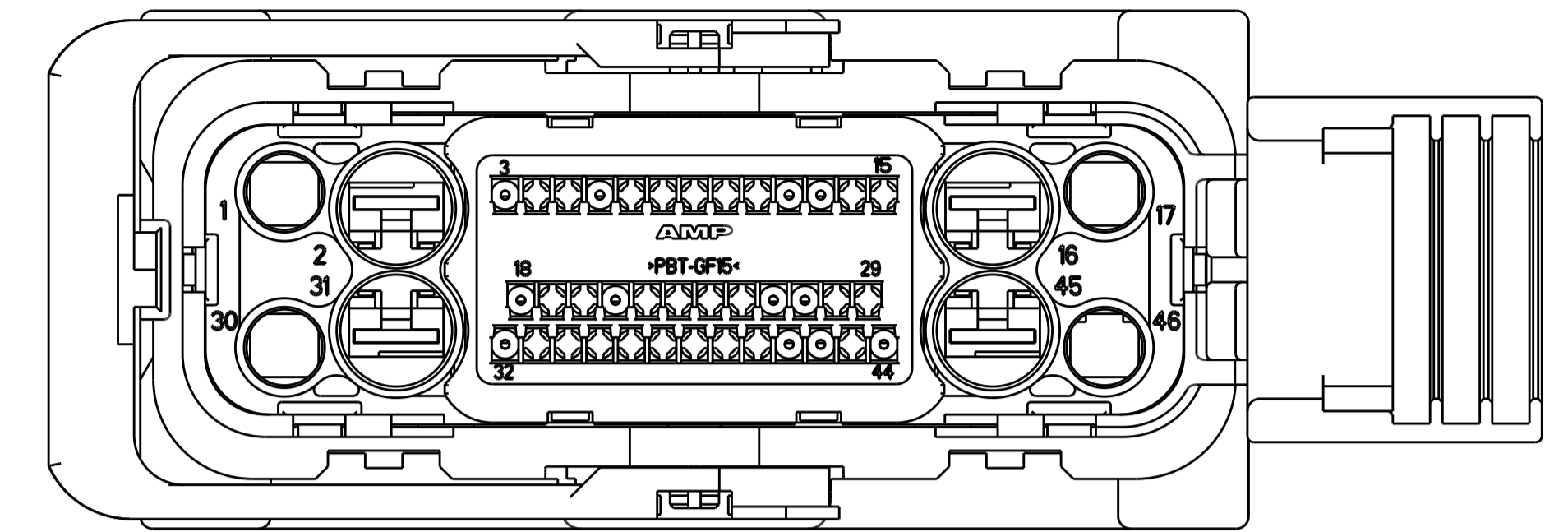

1326327-5
SCALE 2:1

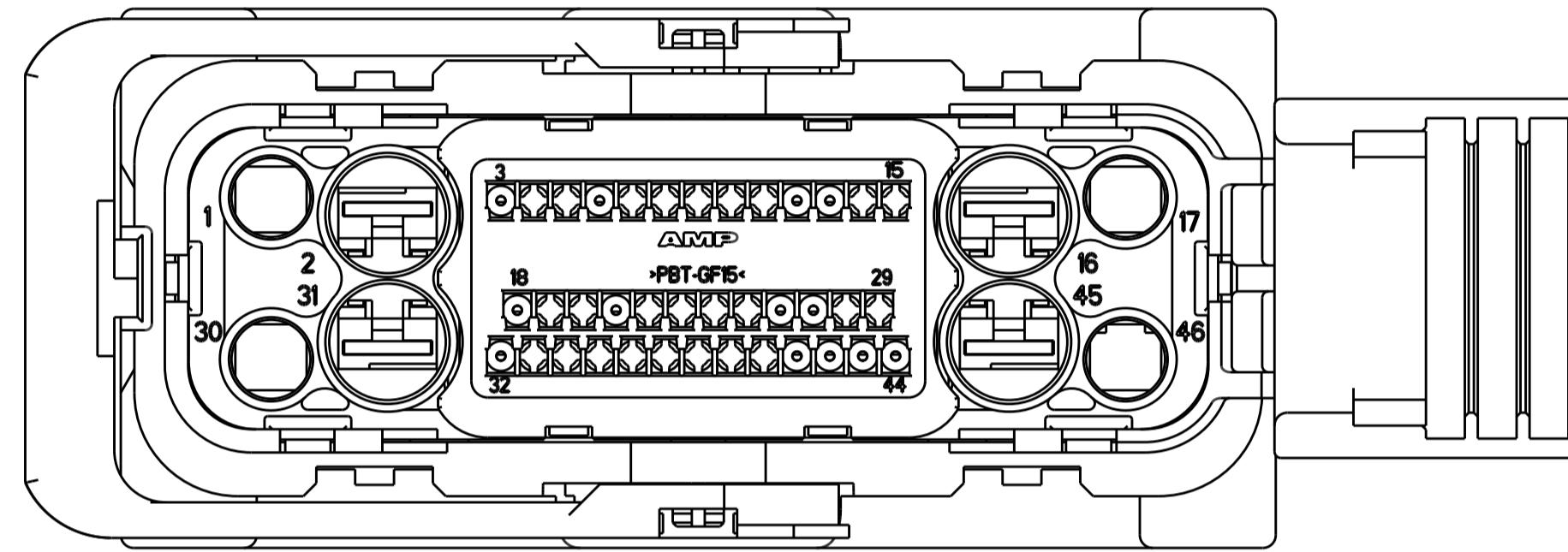

1326327-6
SCALE 2:1

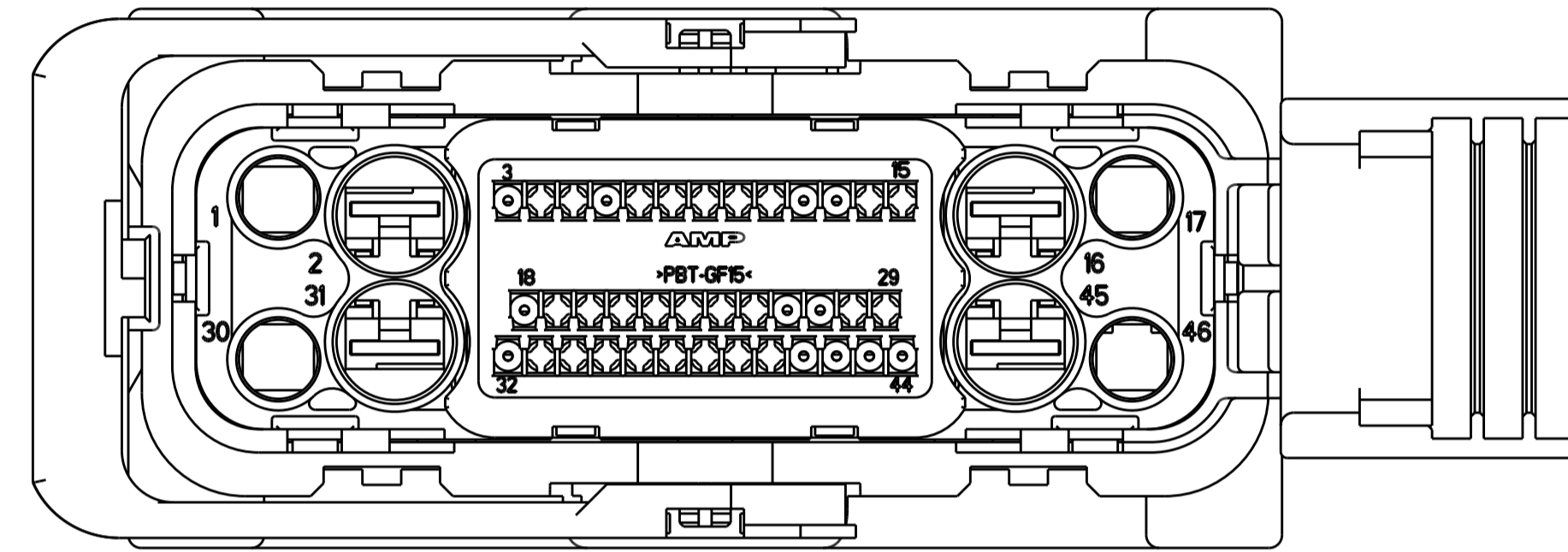

1326327-7
SCALE 2:1

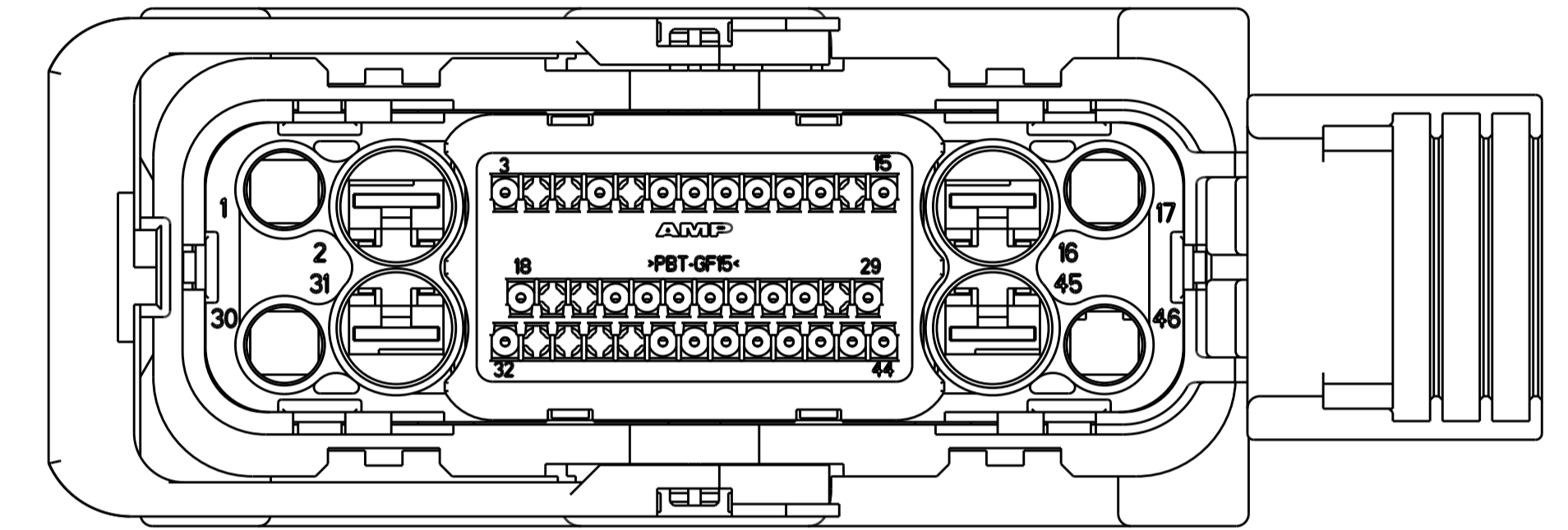

1326327-8
SCALE 2:1

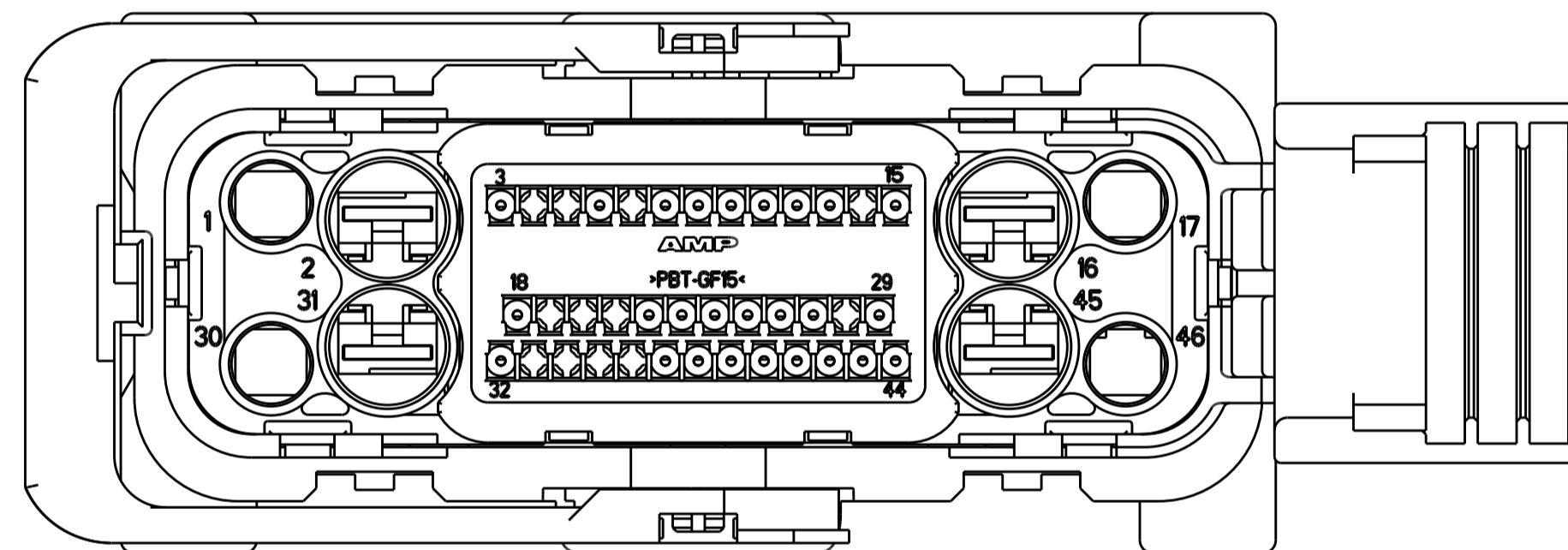

1326327-9
SCALE 2:1

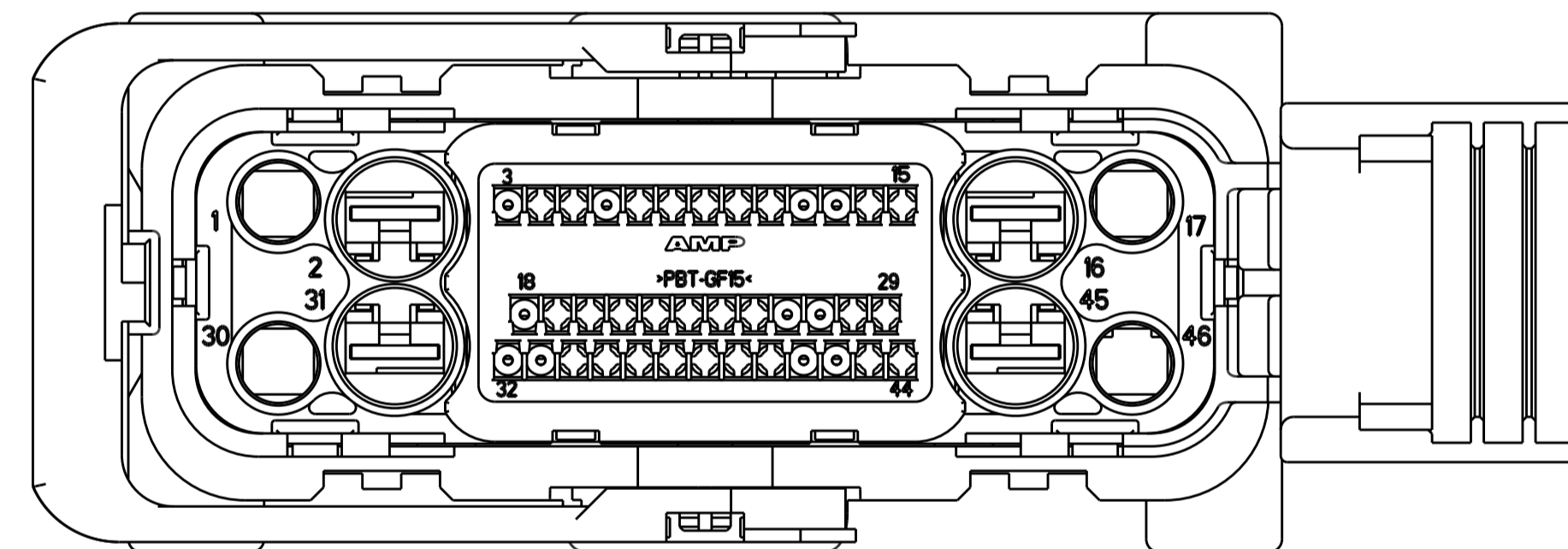

1-1326327-0
SCALE 2:1

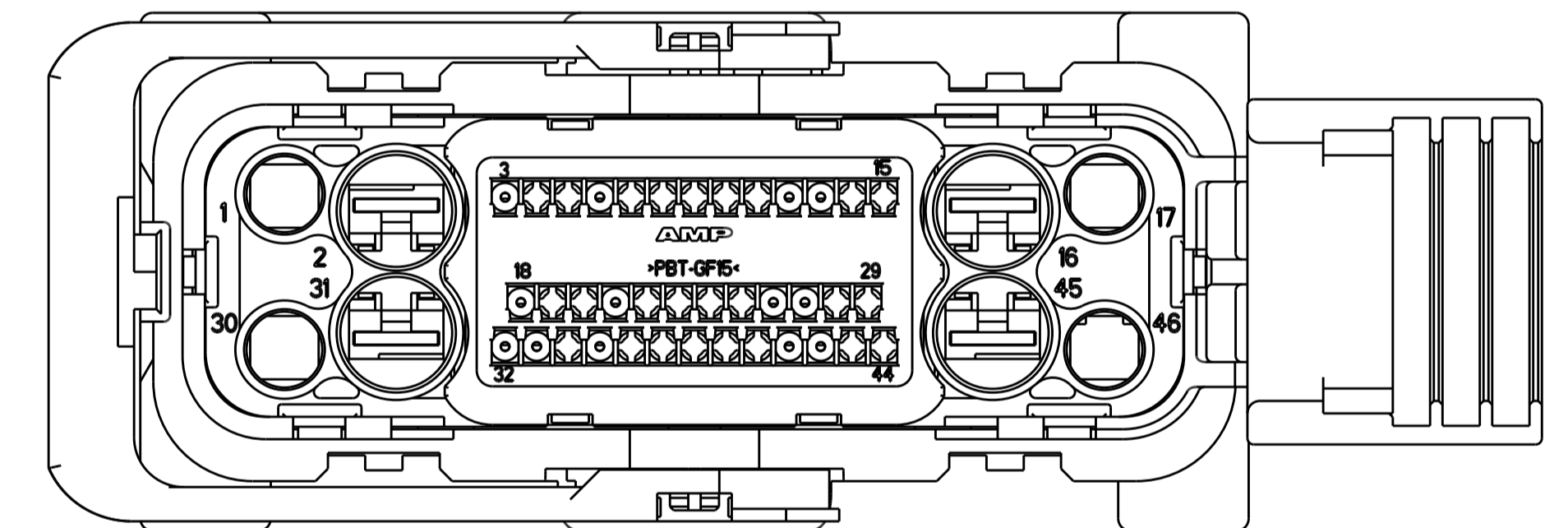

1-1326327-1
SCALE 2:1

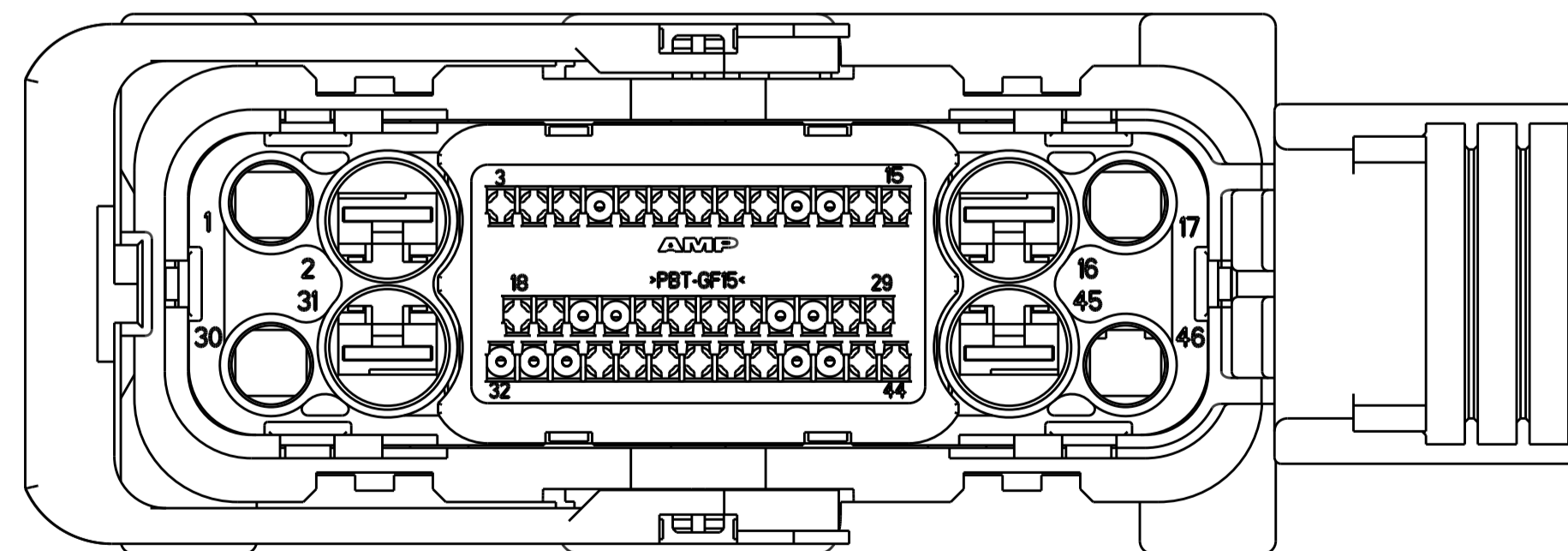

1-1326327-7
SCALE 2:1

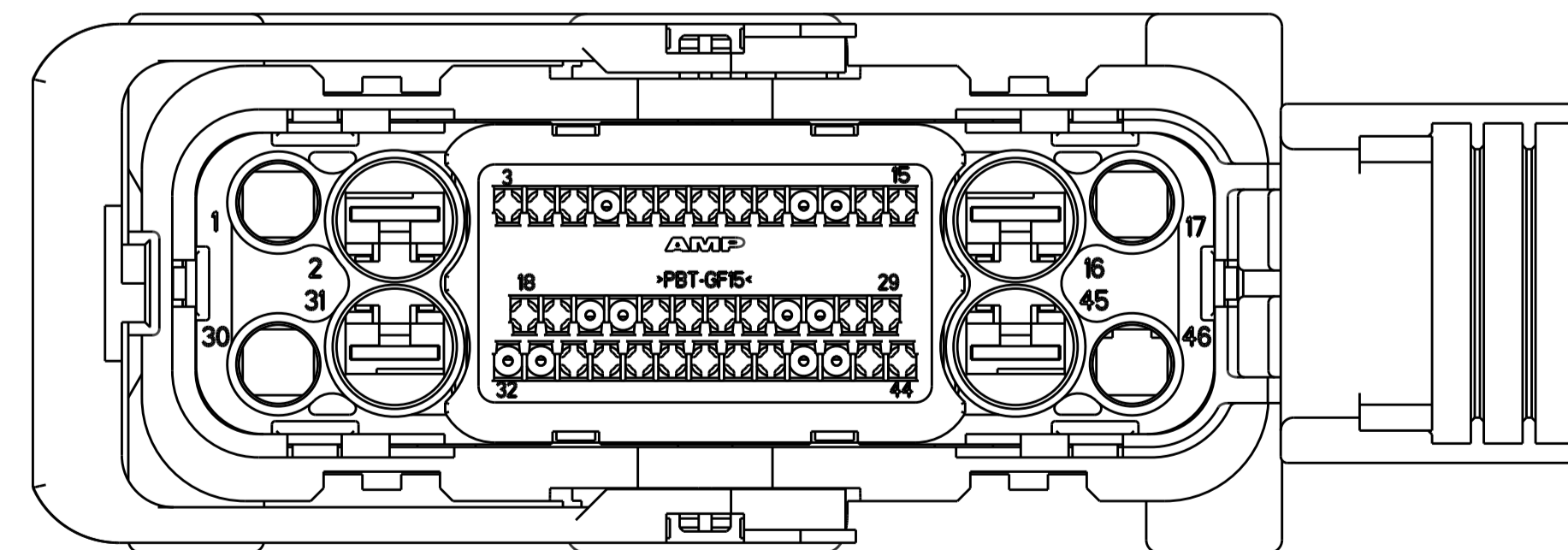

1-1326327-8
SCALE 2:1

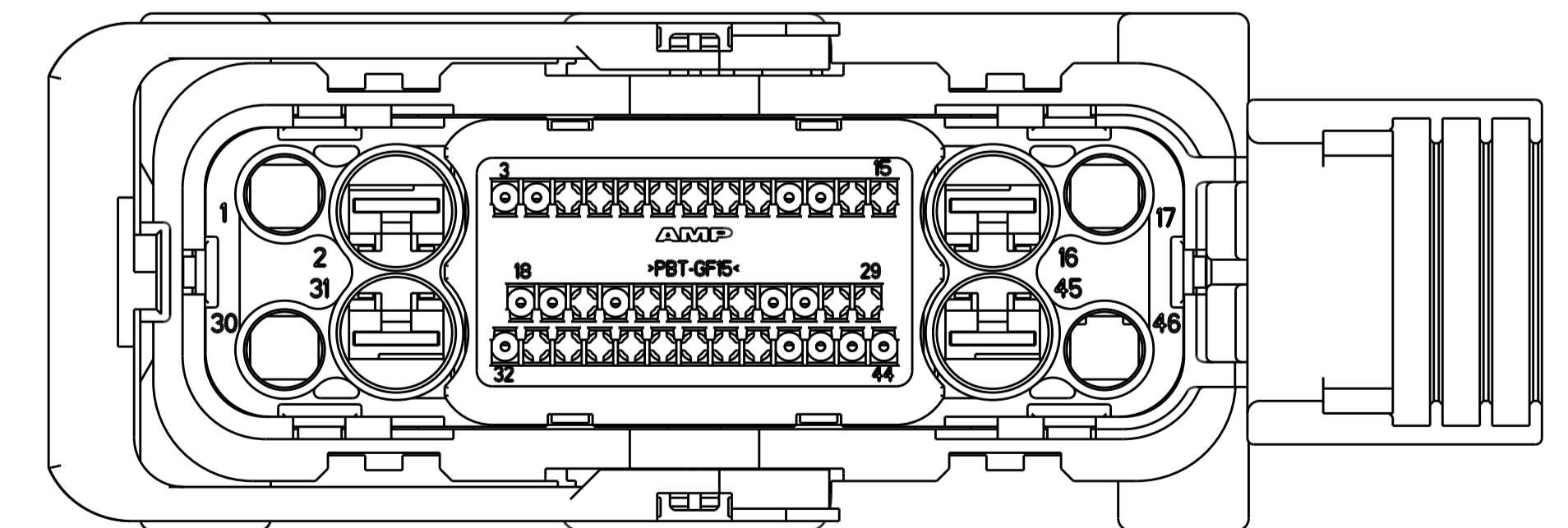

1-1326327-9
SCALE 2:1

THIS DRAWING IS A CONTROLLED DOCUMENT.		OWN: A. HOLT 01APR2003	TE Connectivity DRAWING MATRIX 46 POSITION EBC-440 PLUG ASSEMBLY
DIMENSIONS:		CHK: J. TONEY 01APR2003	
TOLERANCES UNLESS OTHERWISE SPECIFIED:		APPV: J. TONEY 01APR2003	
mm		PRODUCT SPEC	
0 PLC	±	APPLICATION SPEC	SIZE: A1
1 PLC	±	WEIGHT	CAGE CODE: 00779
2 PLC	±	FINISH	DRAWING NO: 1326534
3 PLC	±		SCALE: NONE
4 PLC	±		SHEET 4 OF 12
ANGLES	±		REV: AF7
MATERIAL		Customer Drawing	

PINOUT CONFIGURATION GEOMETRY

LOC	DIST	REV	DATE	BY	APPD
GP	00				

REVISONS		DATE	BY	APPD
1	SEE SHEET 1			

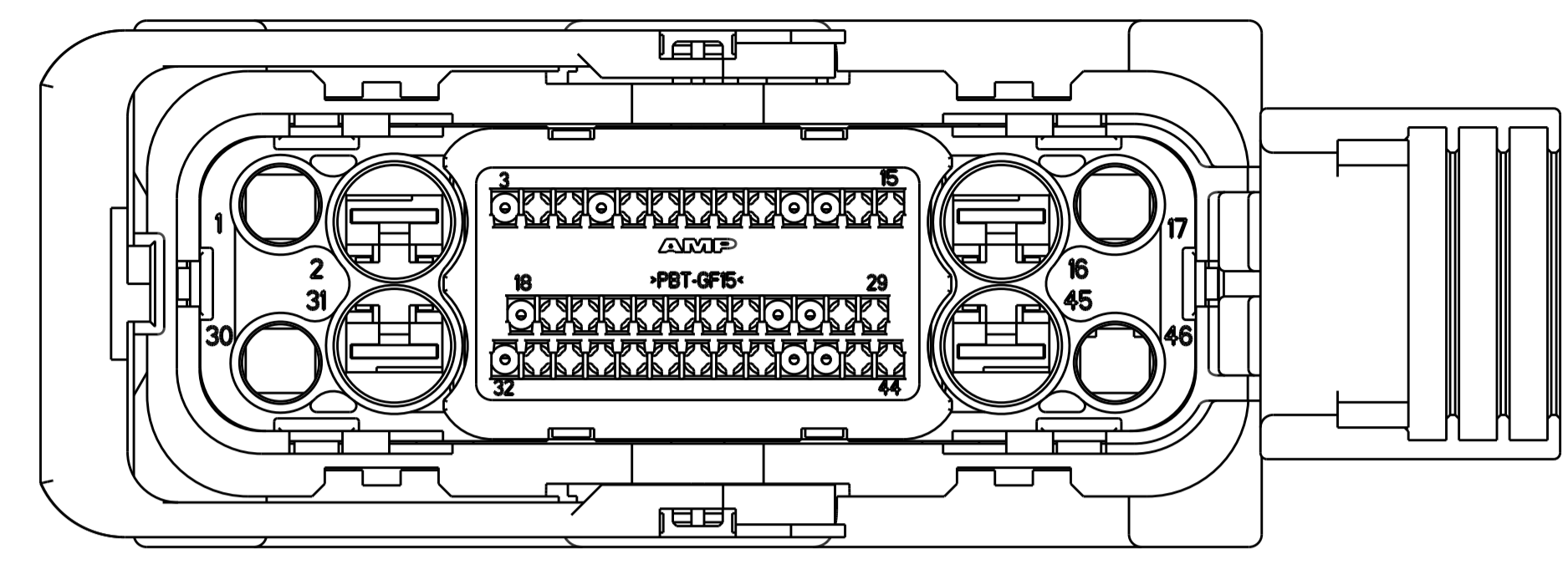

2-1326327-6
SCALE 2:1

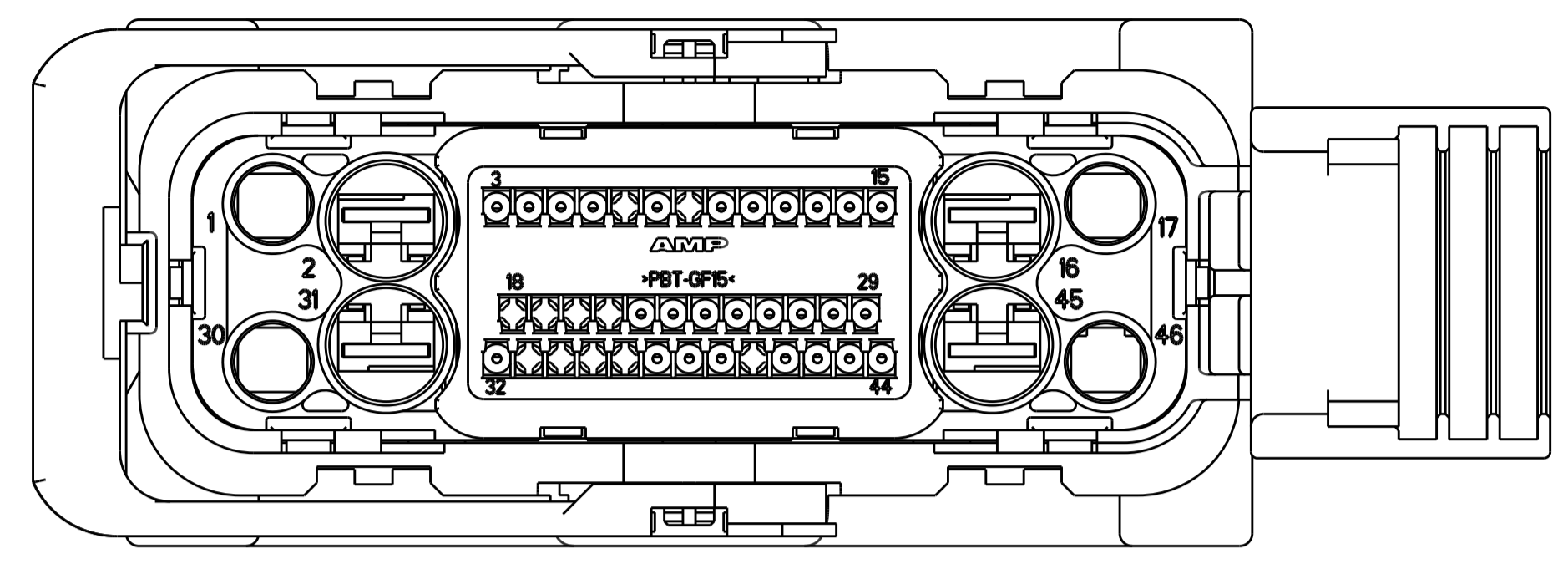

2-1326327-7
SCALE 2:1

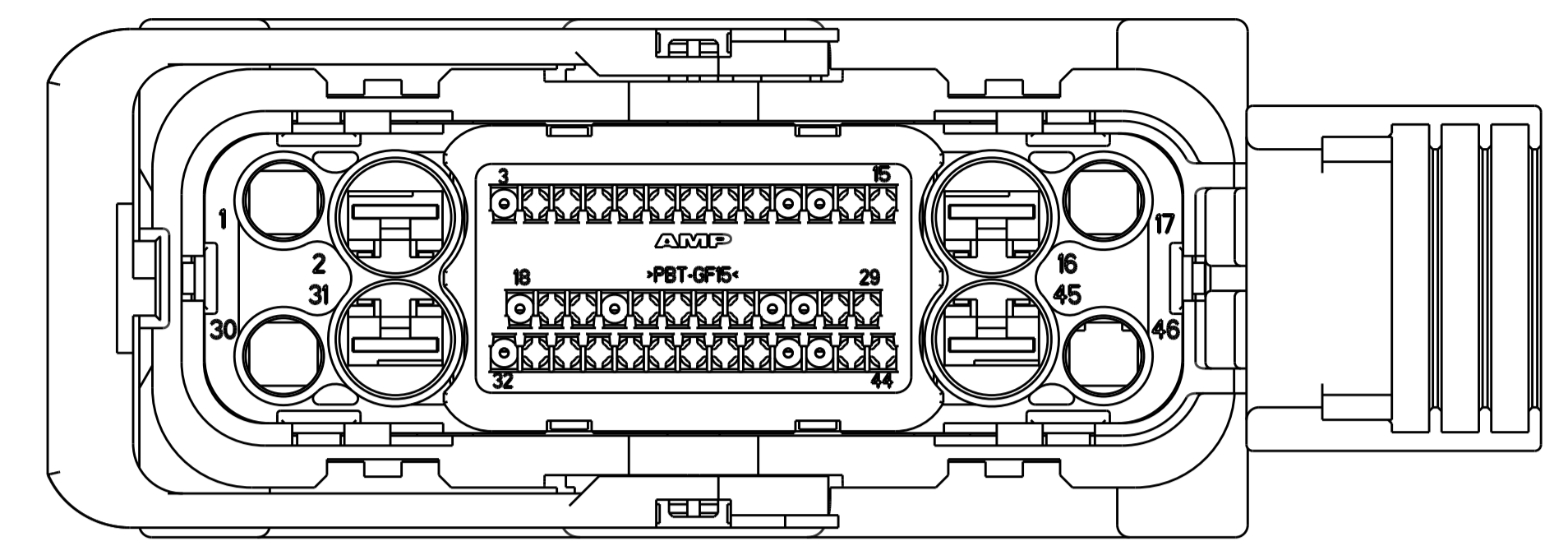

2-1326327-8
SCALE 2:1

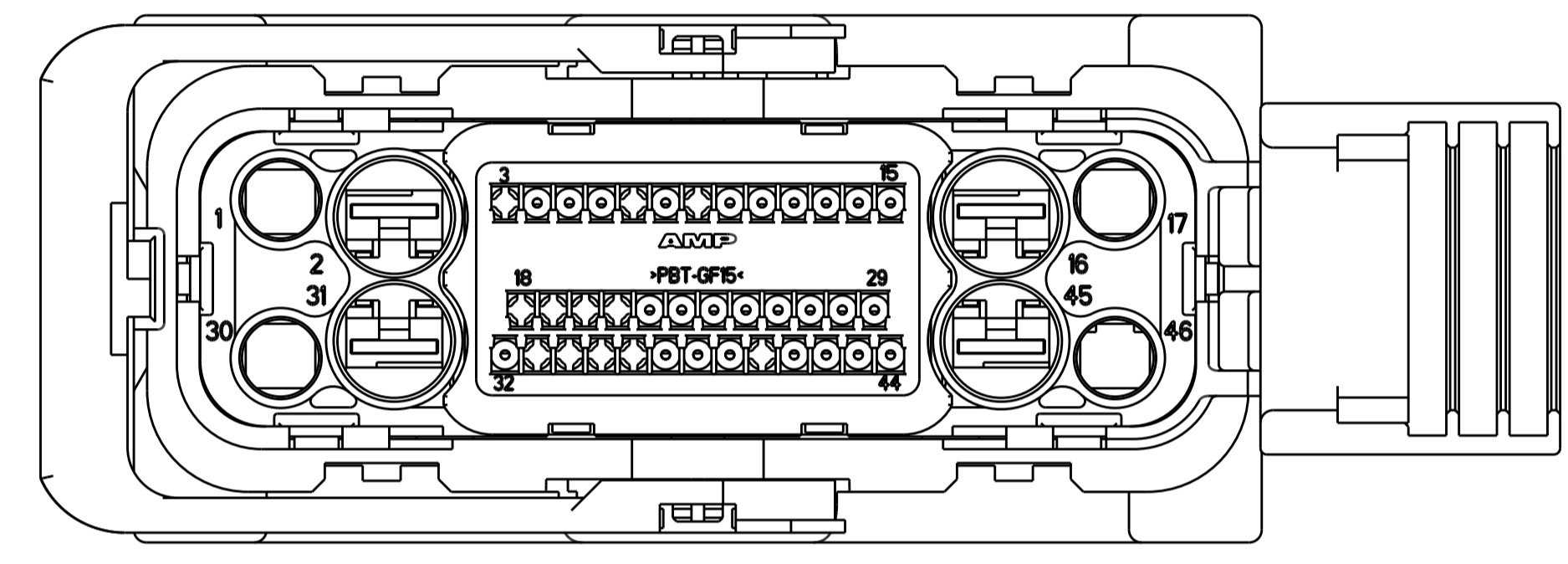

3-1326327-2
SCALE 2:1

THIS DRAWING IS A CONTROLLED DOCUMENT.		OWN A. HOLT 01APR2003	
DIMENSIONS:		CHK J. TONEY 01APR2003	
mm		APPD J. TONEY 01APR2003	
		PRODUCT SPEC	
TOLERANCES UNLESS OTHERWISE SPECIFIED:		APPLICATION SPEC	NAME DRAWING MATRIX 46 POSITION EBC-440 PLUG ASSEMBLY
0 PLC ±		WEIGHT	SIZE A1
1 PLC ±		SCALE NONE	CAGE CODE 00779
2 PLC ±		RESTRICTED TO	DRAWING NO 1326534
3 PLC ±			REV AF7
4 PLC ±			
ANGLES ±			
FINISH			
MATERIAL		Customer Drawing	SHEET 5 OF 12

PINOUT CONFIGURATION GEOMETRY

LOC	DIST	REV	DATE	APPD	DESCRIPTION
GP	00				SEE SHEET 1

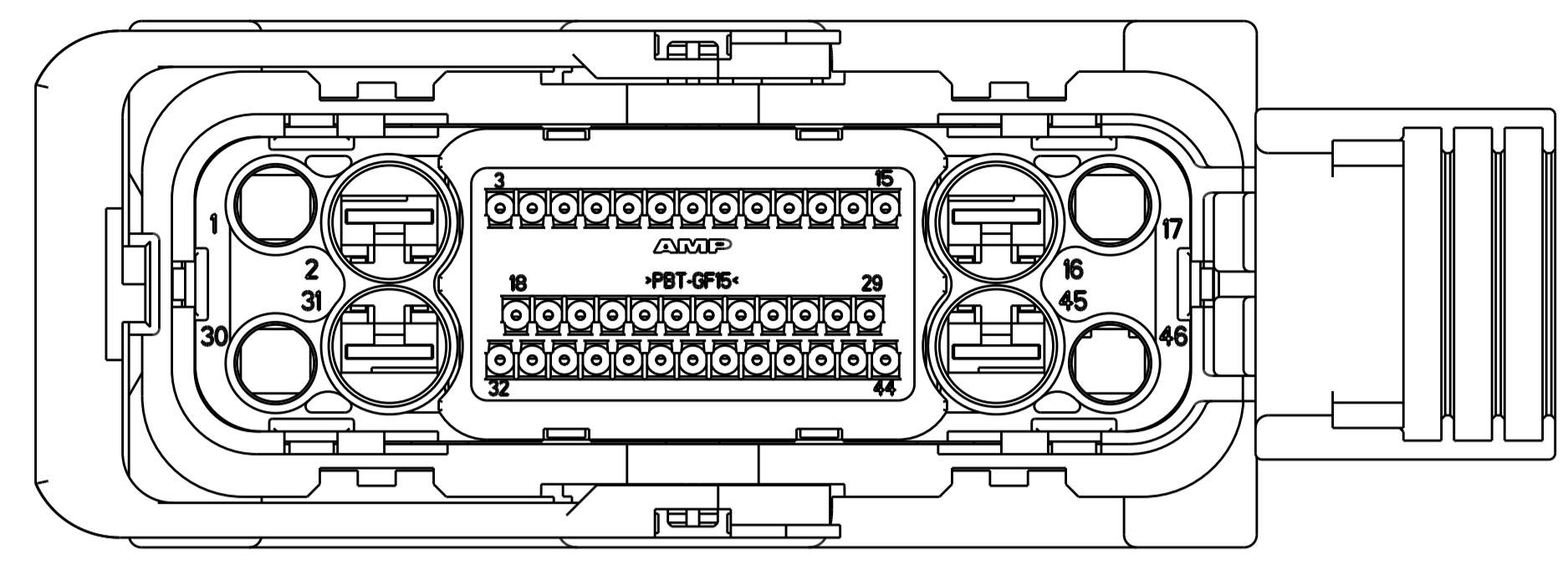

1326328-1
SCALE 2:1

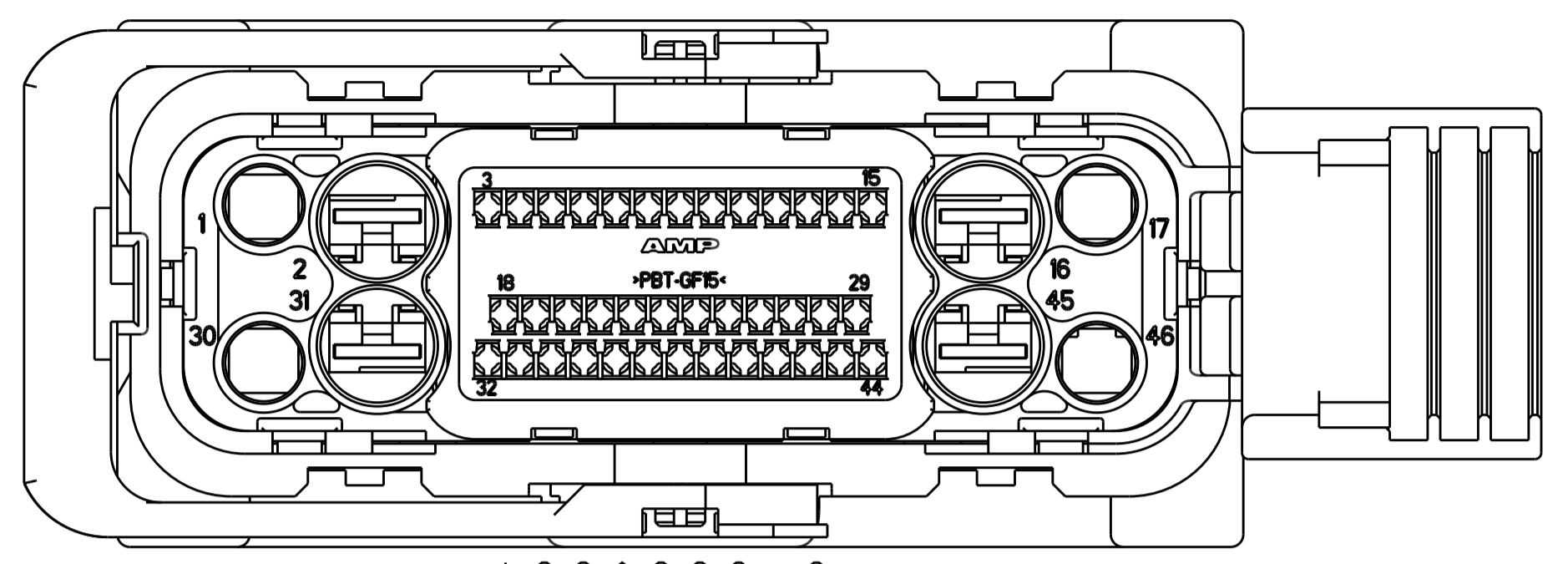

1326328-2
SCALE 2:1

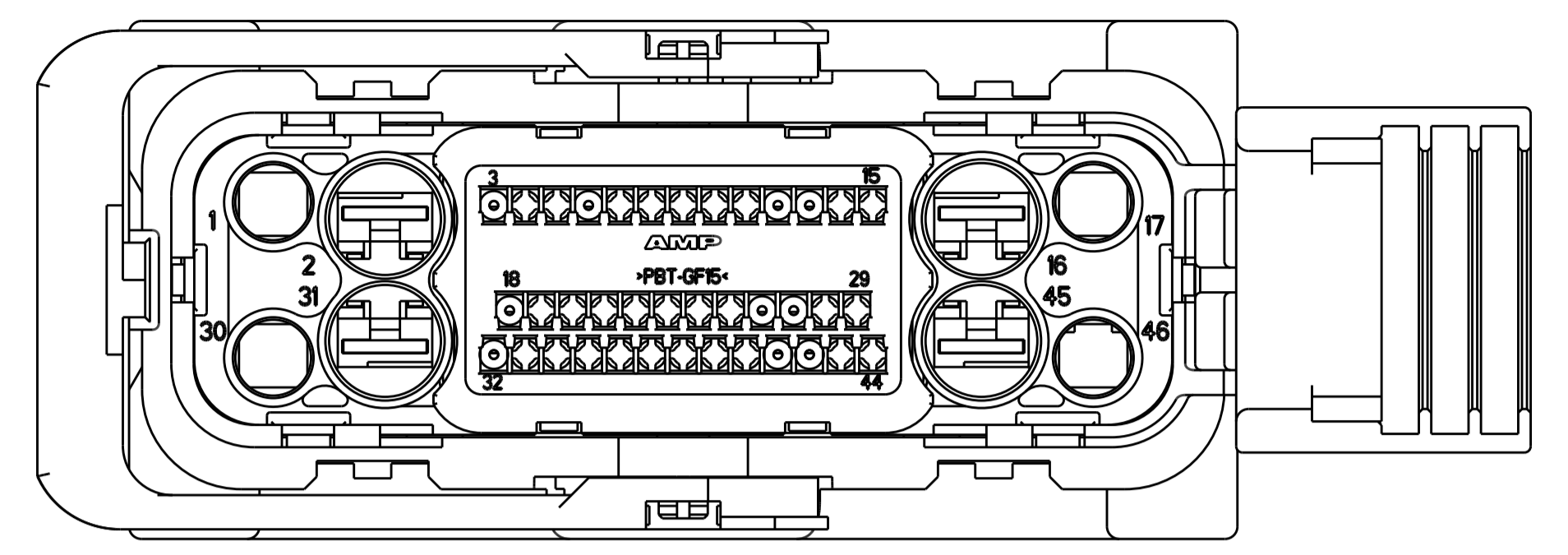

1326328-3
SCALE 2:1

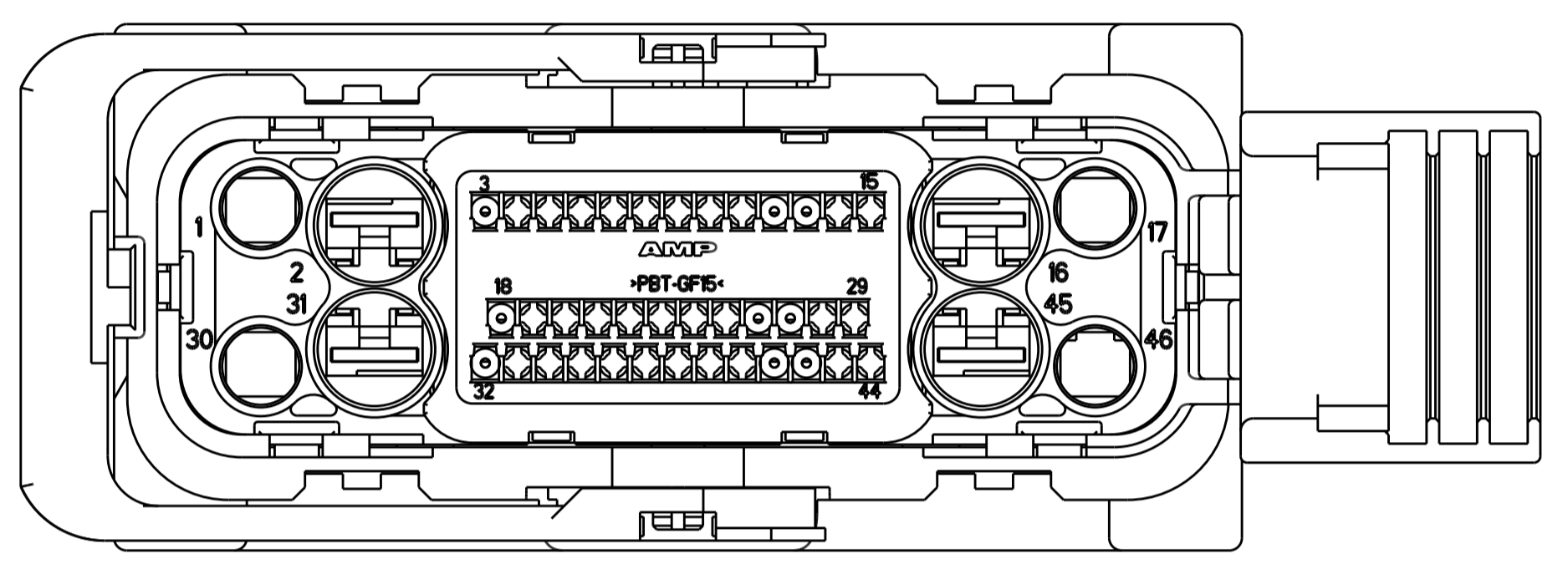

1326328-4
SCALE 2:1

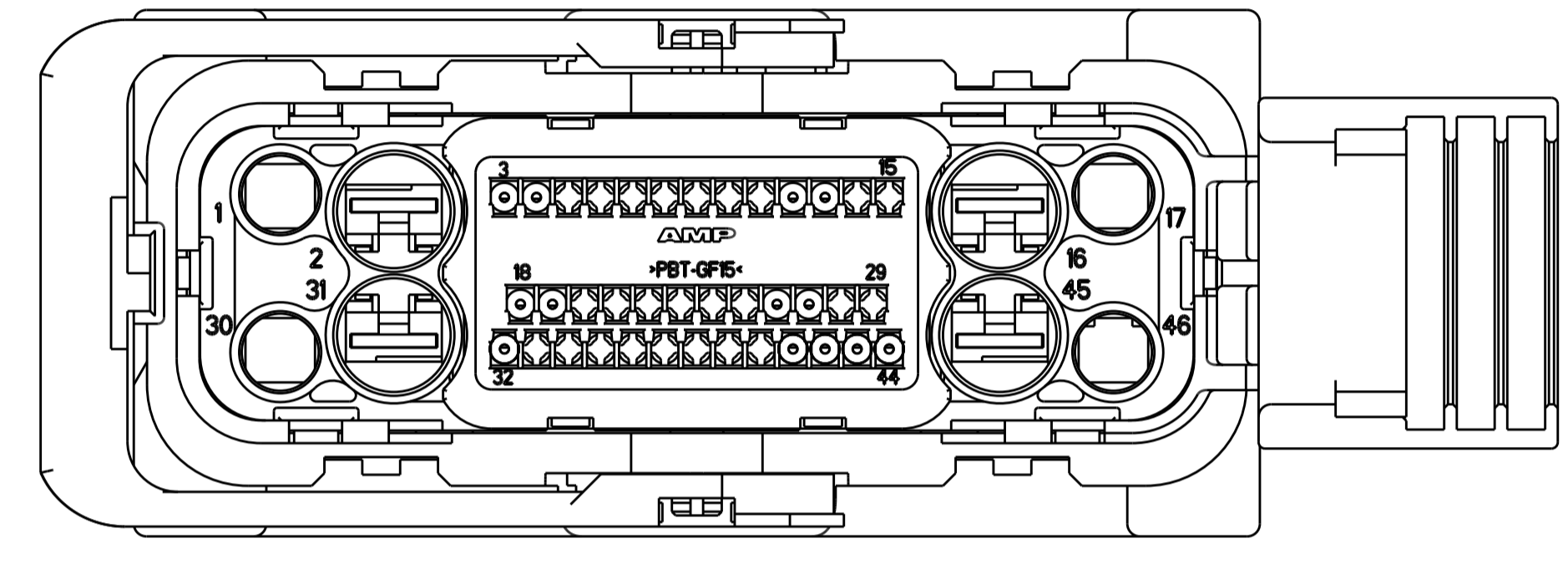

1326328-5
SCALE 2:1

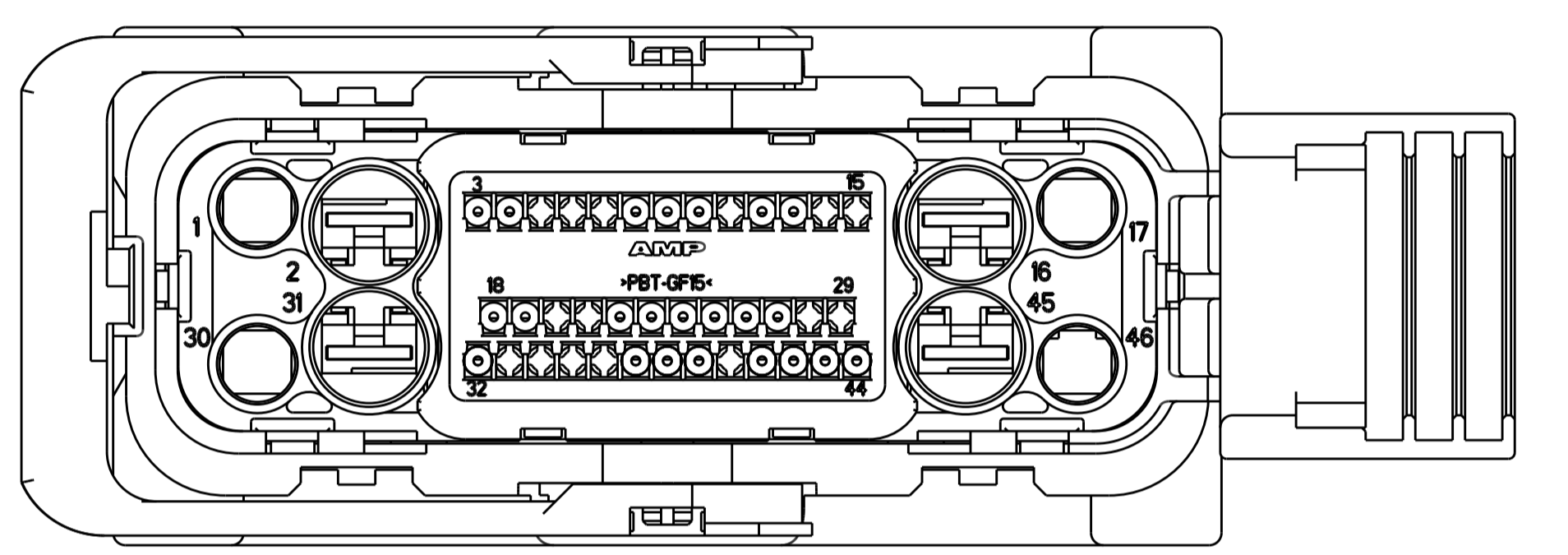

1326328-6
SCALE 2:1

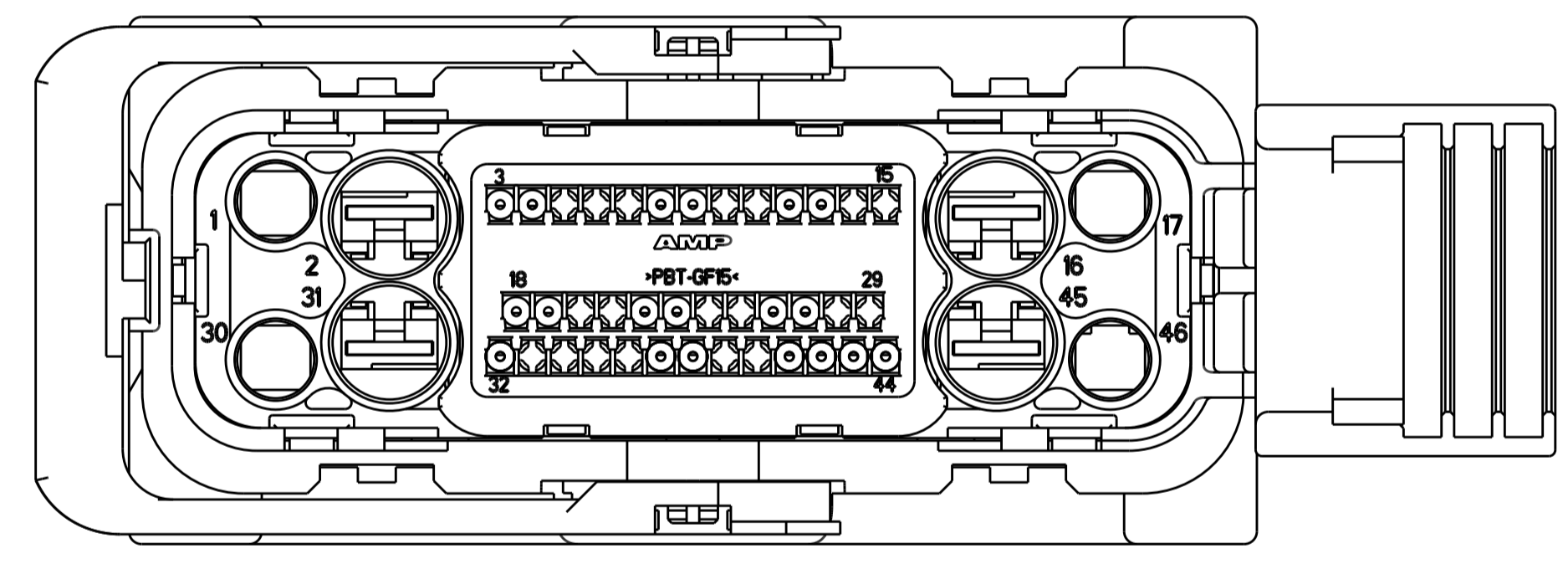

1326328-7
SCALE 2:1

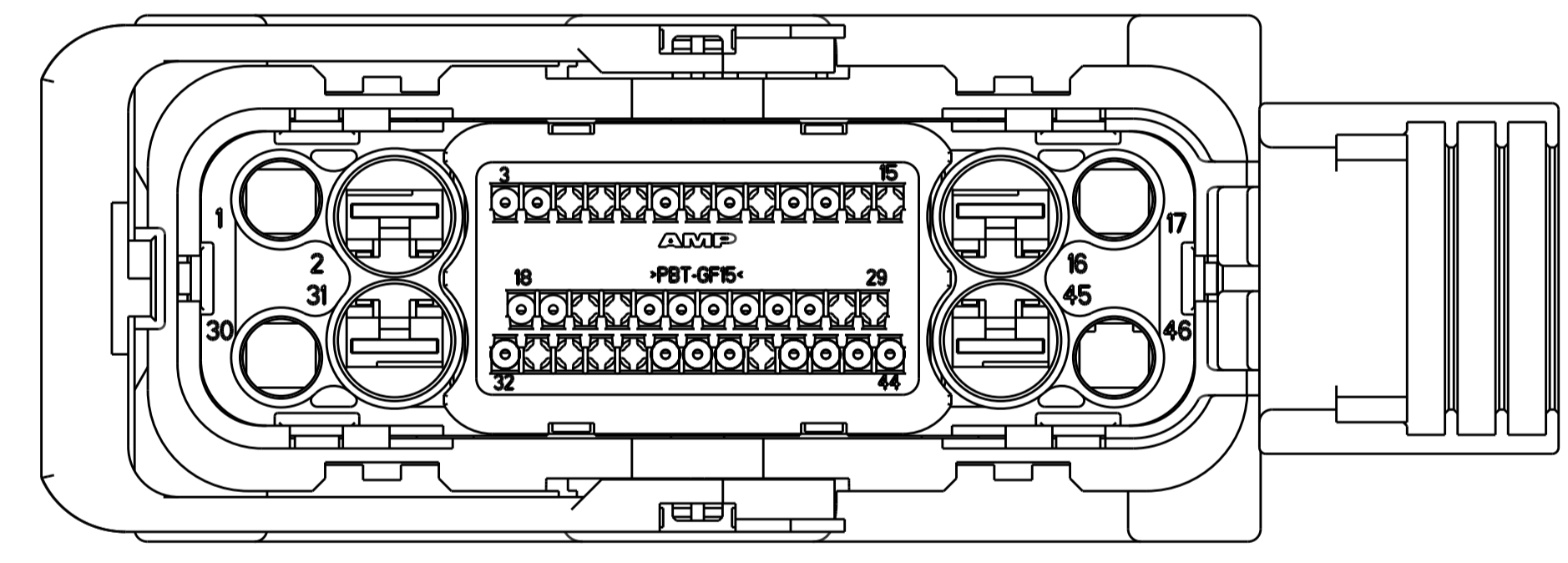

1326328-8
SCALE 2:1

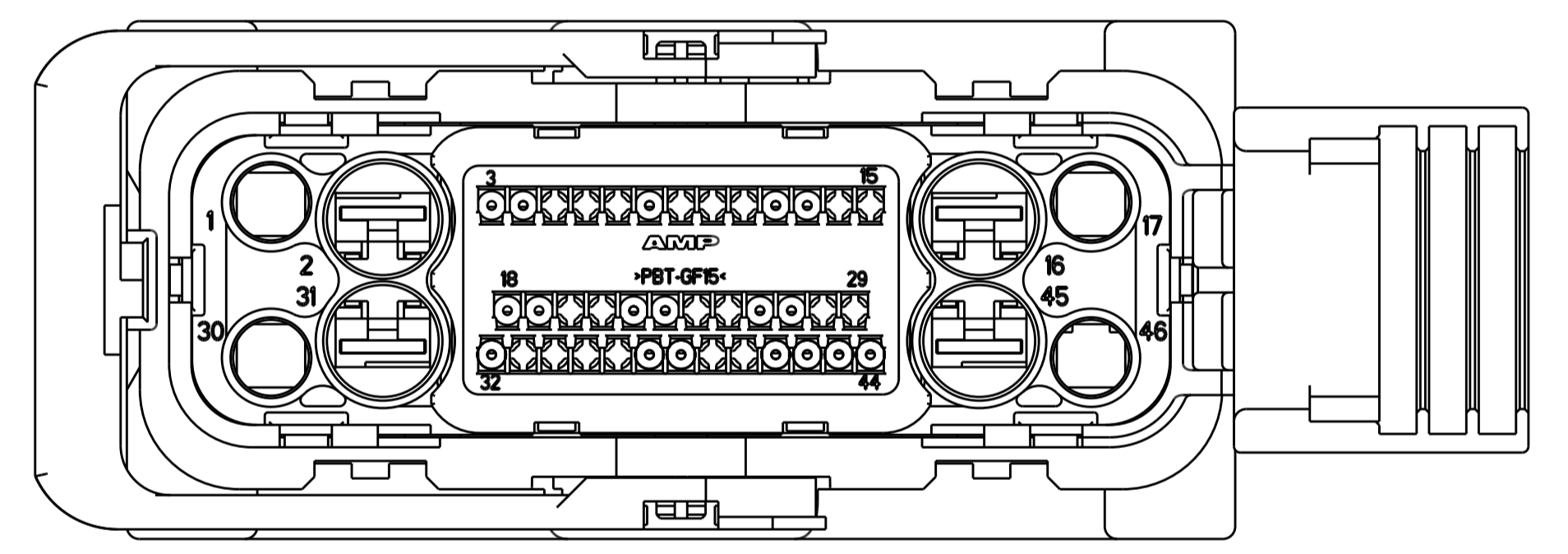

1326328-9
SCALE 2:1

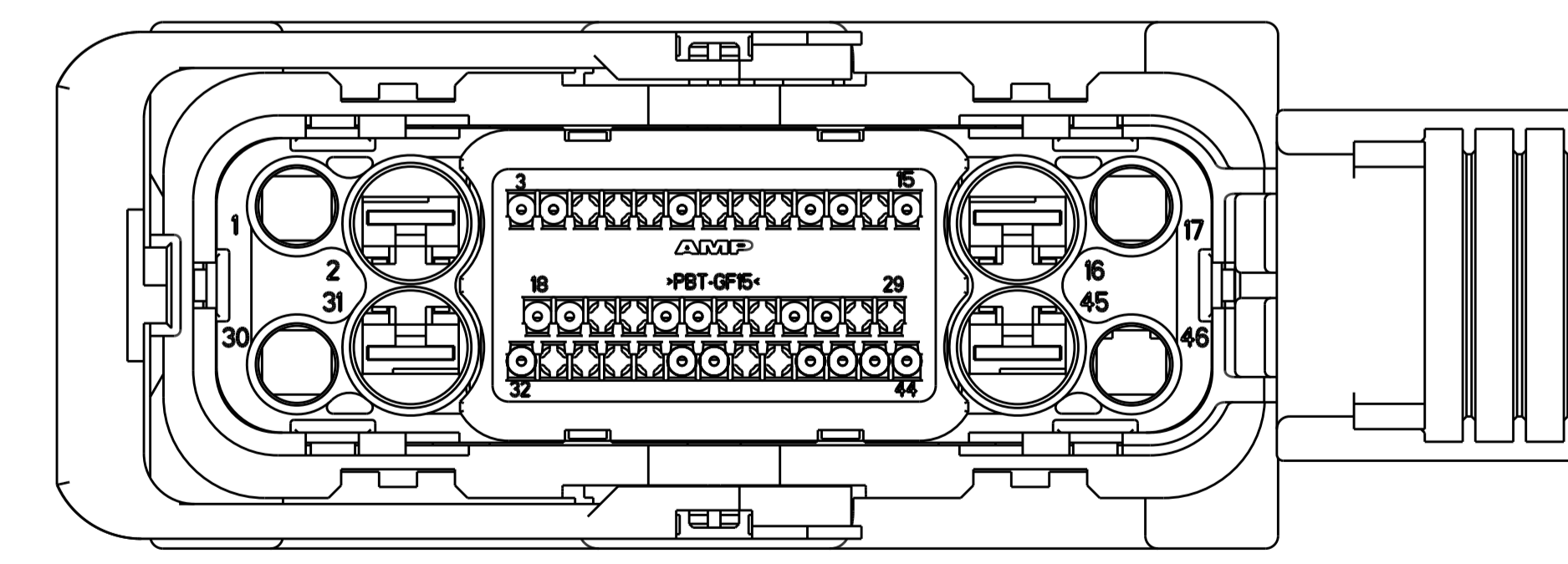

1-1326328-0
SCALE 2:1

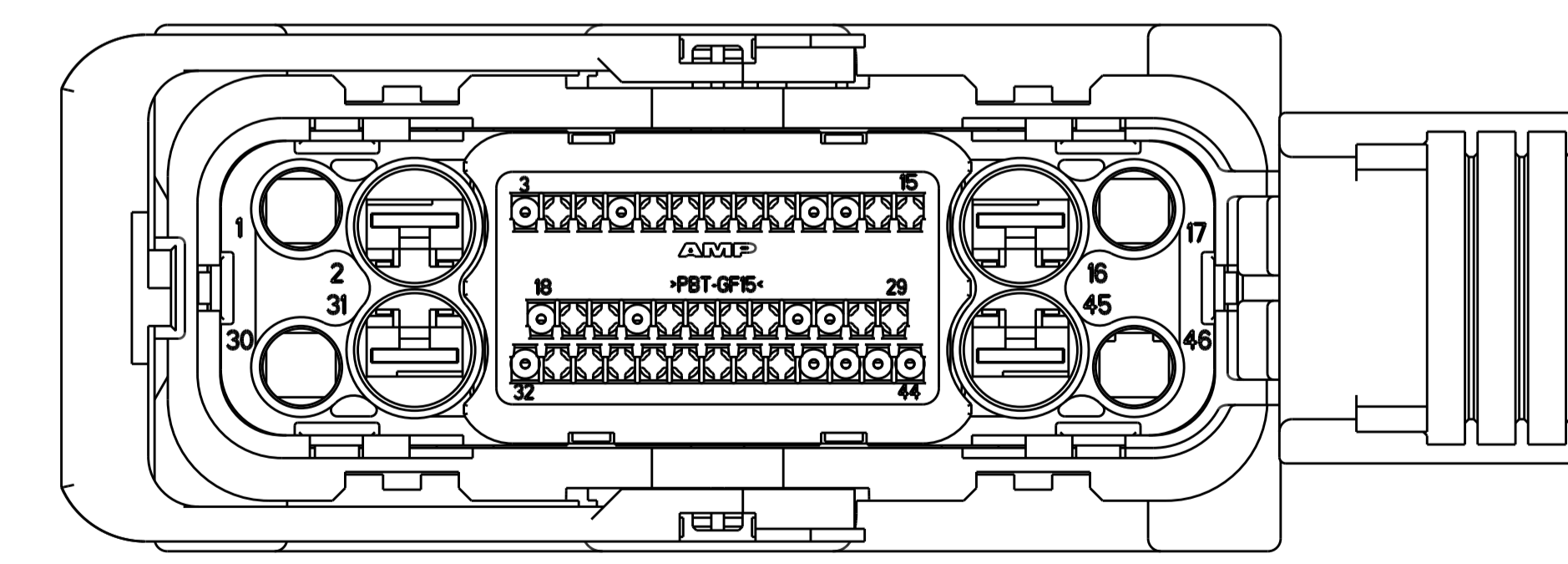

1-1326328-1
SCALE 2:1

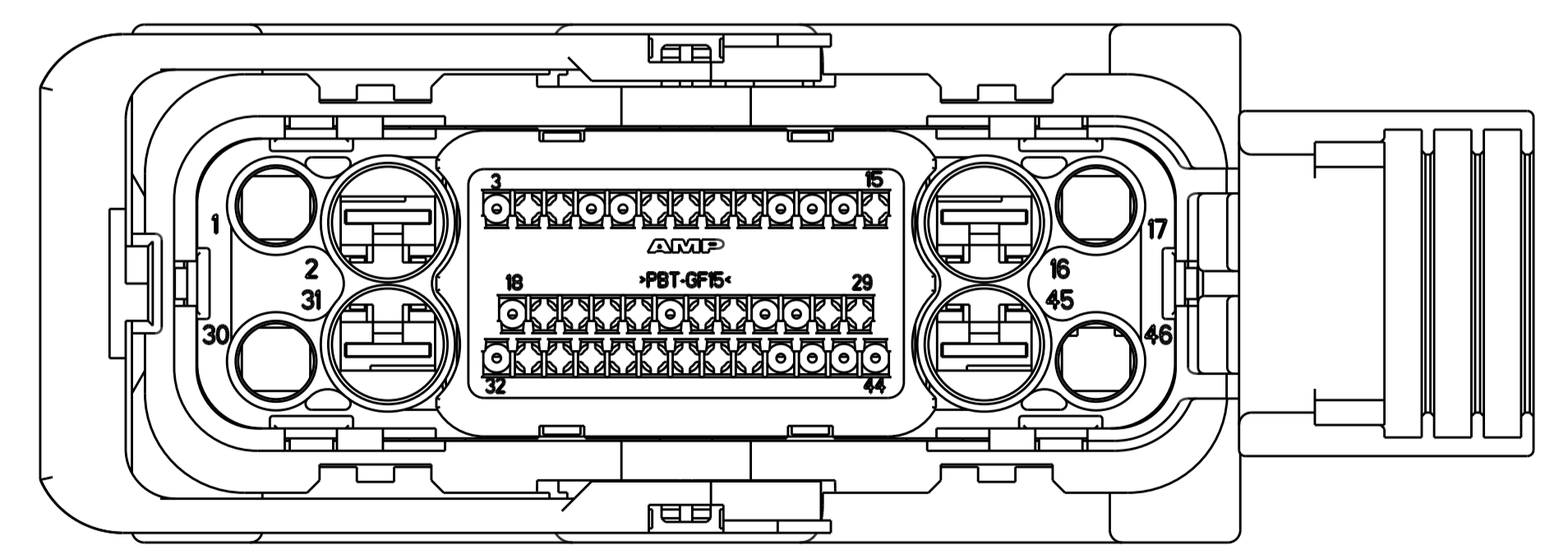

1-1326328-2
SCALE 2:1

THIS DRAWING IS A CONTROLLED DOCUMENT.		OWN: A. HOLT 01APR2003	TE Connectivity
DIMENSIONS:		CHK: J. TONEY 01APR2003	
mm	0 PLC ±	APVD: J. TONEY 01APR2003	NAME: DRAWING MATRIX 46 POSITION EBC-440 PLUG ASSEMBLY
	1 PLC ±	PRODUCT SPEC	
	2 PLC ±	APPLICATION SPEC	SIZE: A1
	3 PLC ±	WEIGHT	CAGE CODE: 00779
	4 PLC ±	MATERIAL	DRAWING NO: 1326534
	ANGLES ±	FINISH	SCALE: NONE
			SHEET 6 OF 12
			REV: AF7

LOC	DIST	REVISIONS			
P	LTN	DESCRIPTION	DATE	DWN	APVD
-	-	SEE SHEET 1	-	-	-

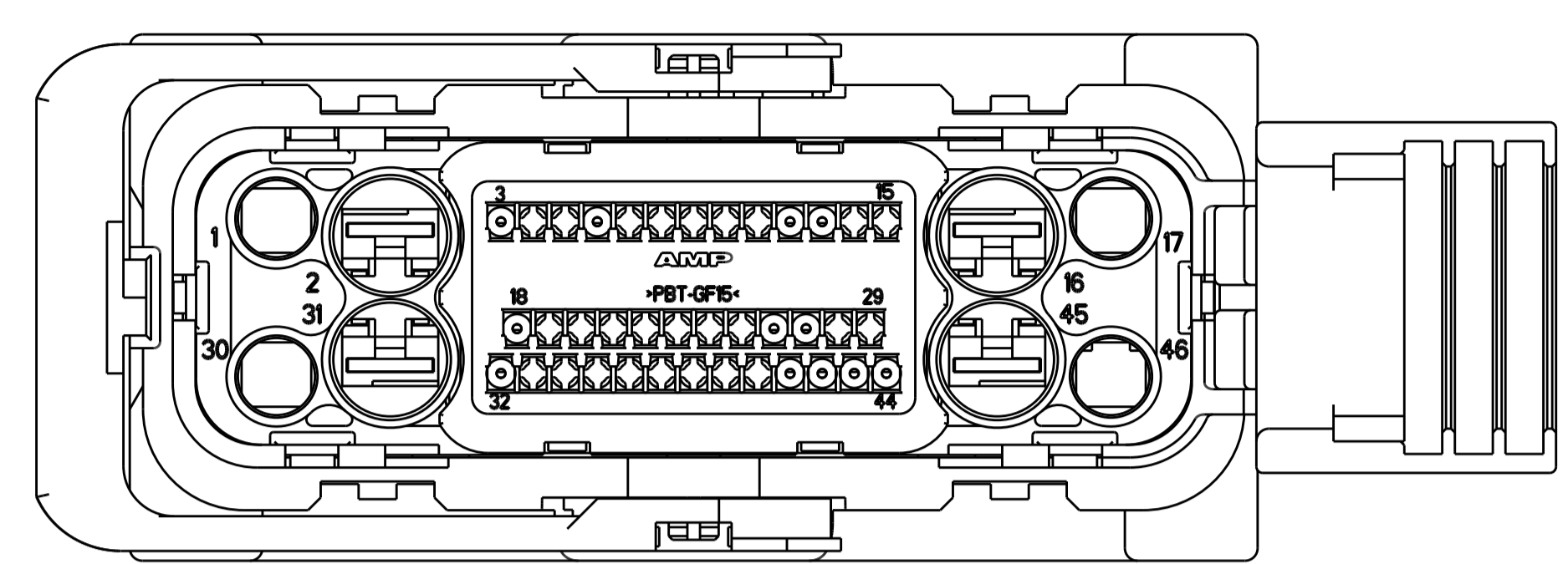

2-1326328-1
SCALE 2:1

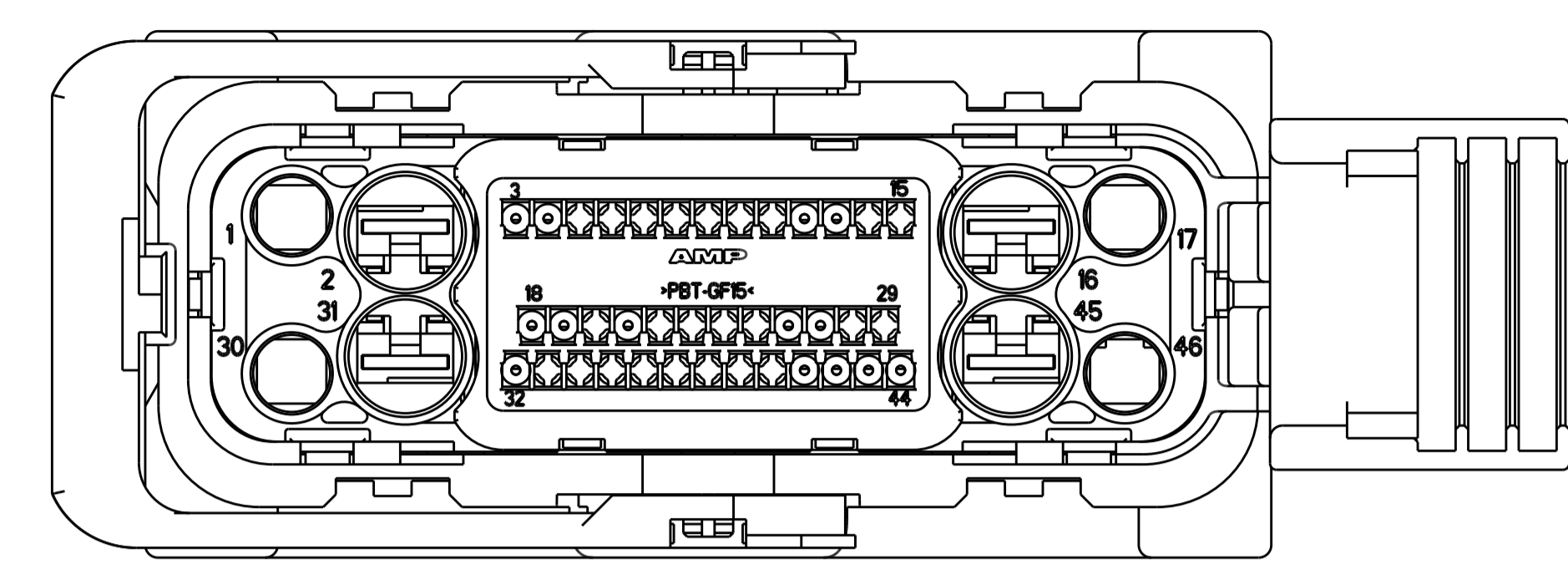

3-1326328-4
SCALE 2:1

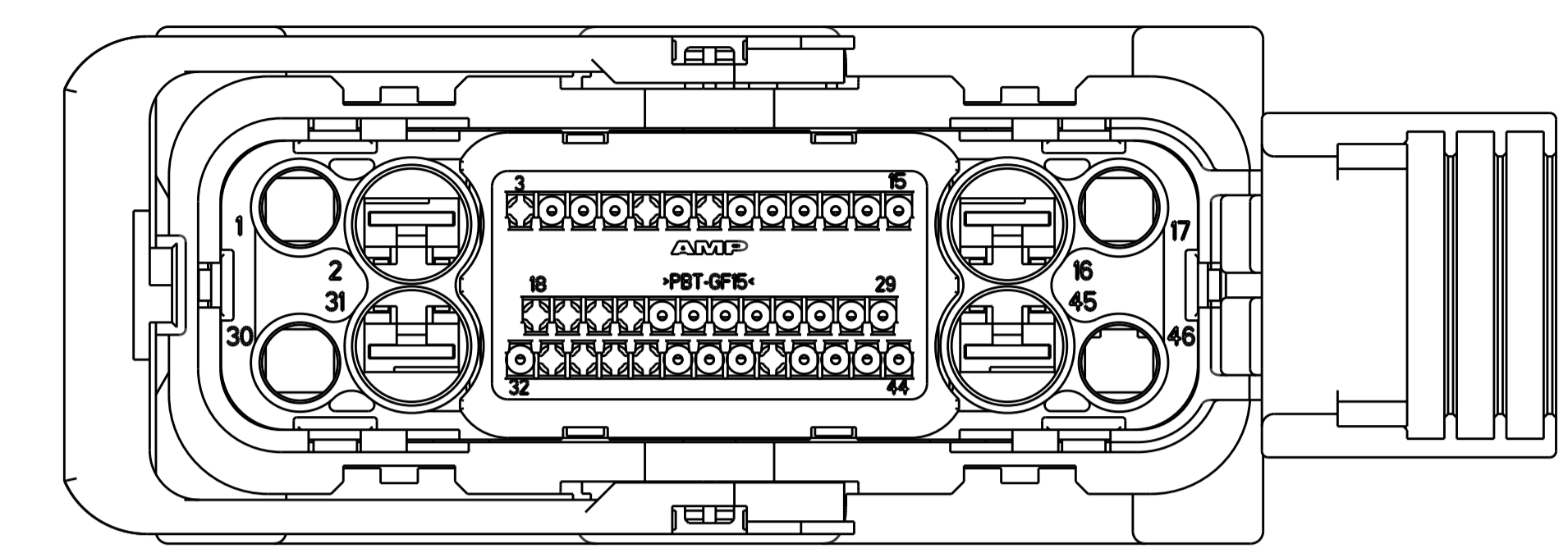

3-1326328-9
SCALE 2:1

THIS DRAWING IS A CONTROLLED DOCUMENT.		DWN A. HOLT 01APR2003															
DIMENSIONS:		CHK J. TONEY 01APR2003															
TOLERANCES UNLESS OTHERWISE SPECIFIED:		APVD J. TONEY 01APR2003															
mm		PRODUCT SPEC															
<table border="1"> <tr><td>0 PLC</td><td>±</td></tr> <tr><td>1 PLC</td><td>±</td></tr> <tr><td>2 PLC</td><td>±</td></tr> <tr><td>3 PLC</td><td>±</td></tr> <tr><td>4 PLC</td><td>±</td></tr> <tr><td>ANGLES</td><td>±</td></tr> <tr><td>FINISH</td><td>±</td></tr> </table>		0 PLC	±	1 PLC	±	2 PLC	±	3 PLC	±	4 PLC	±	ANGLES	±	FINISH	±	APPLICATION SPEC	NAME DRAWING MATRIX 46 POSITION EBC-440 PLUG ASSEMBLY
0 PLC	±																
1 PLC	±																
2 PLC	±																
3 PLC	±																
4 PLC	±																
ANGLES	±																
FINISH	±																
MATERIAL		WEIGHT	RESTRICTED TO														
		Customer Drawing	SIZE CAGE CODE DRAWING NO A1 00779 C=1326534														
SCALE NONE			SHEET 7 OF 12 REV AF7														

PINOUT CONFIGURATION GEOMETRY

LOC	DIST	REVISIONS					
GP	00	P	LYR	DESCRIPTION	DATE	OWN	APVD
		-		SEE SHEET 1			

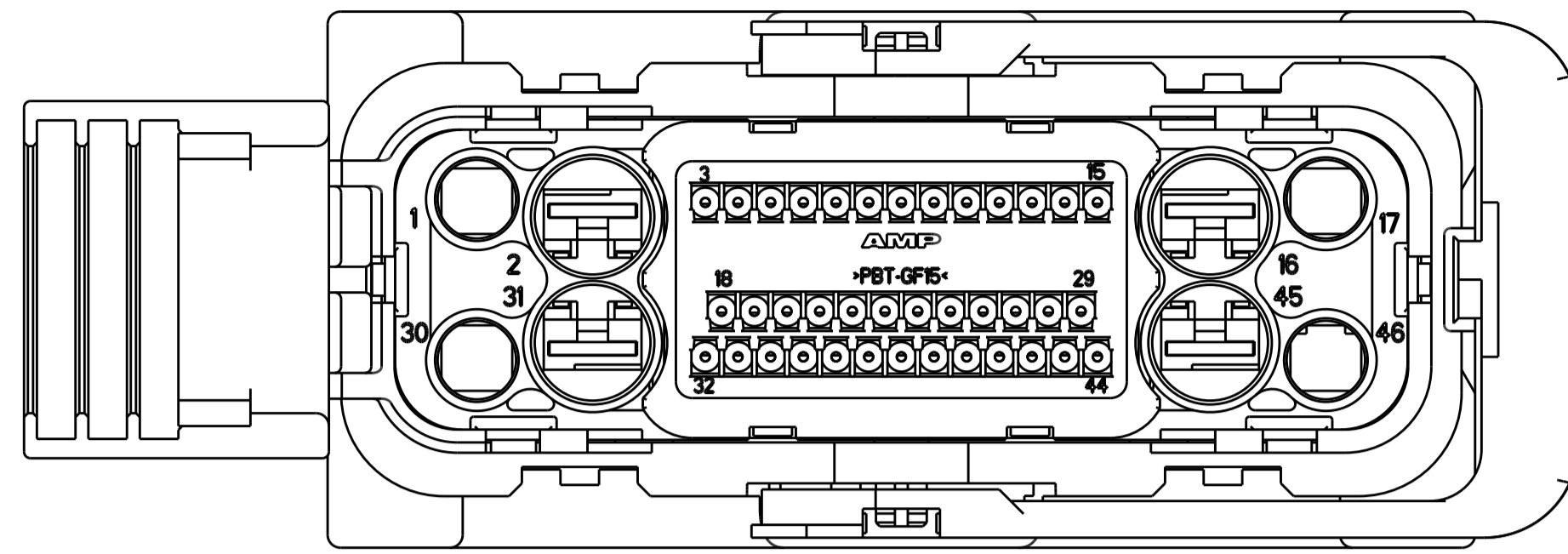

1326338-1
SCALE 2:1

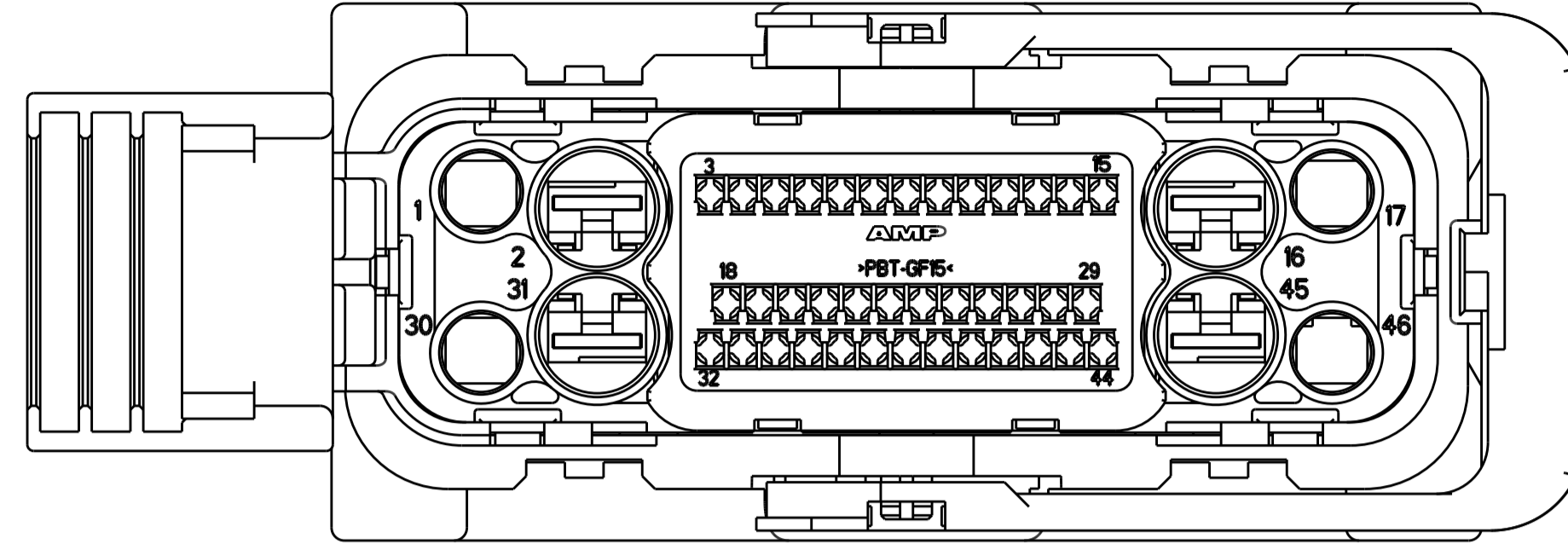

1326338-2
SCALE 2:1

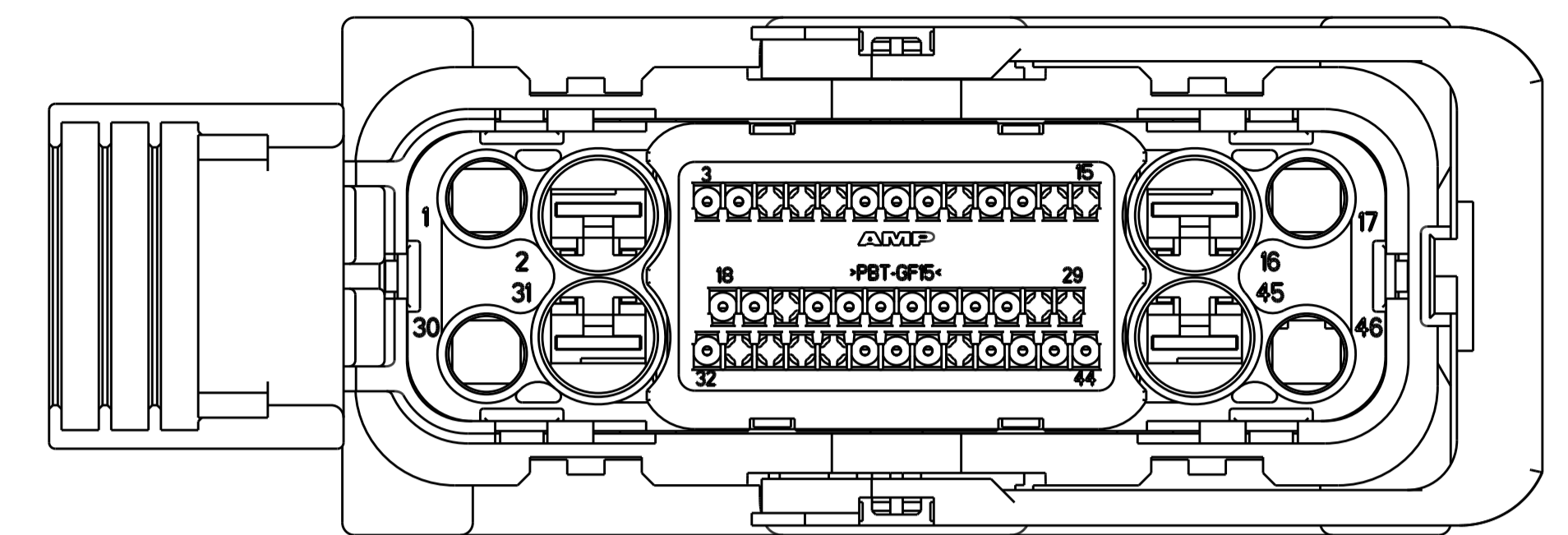

1-1326338-0
SCALE 2:1

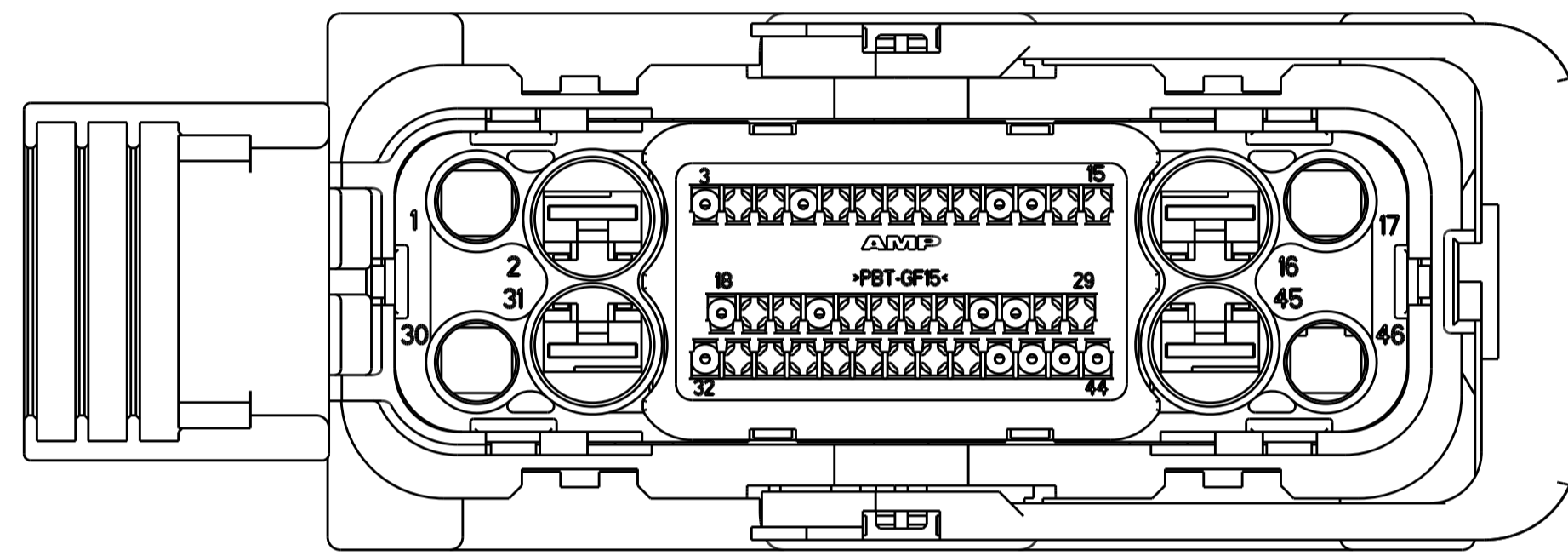

1-1326338-1
SCALE 2:1

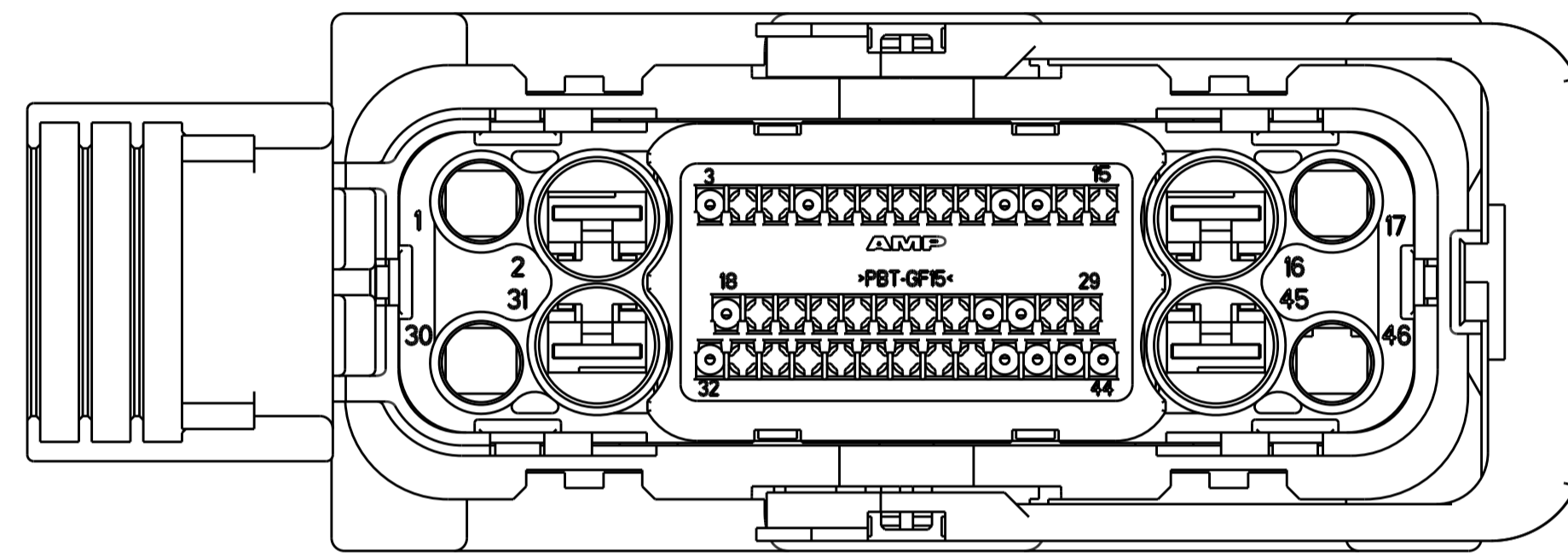

1-1326338-2
SCALE 2:1

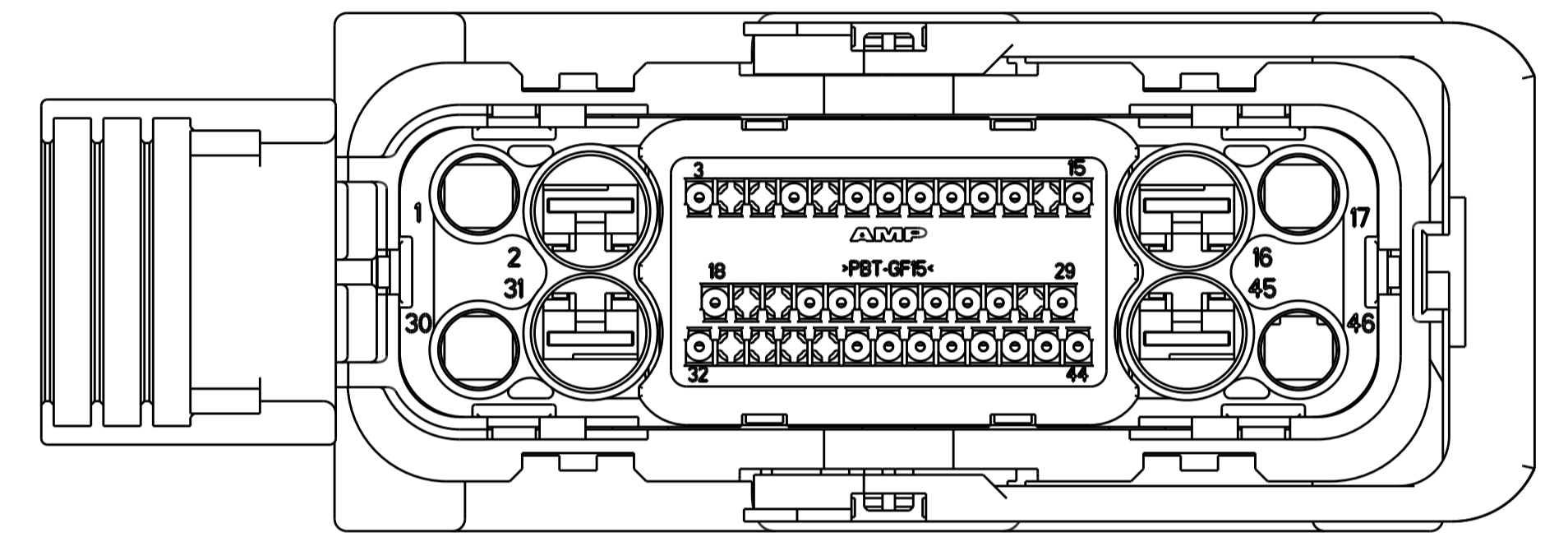

1-1326338-3
SCALE 2:1

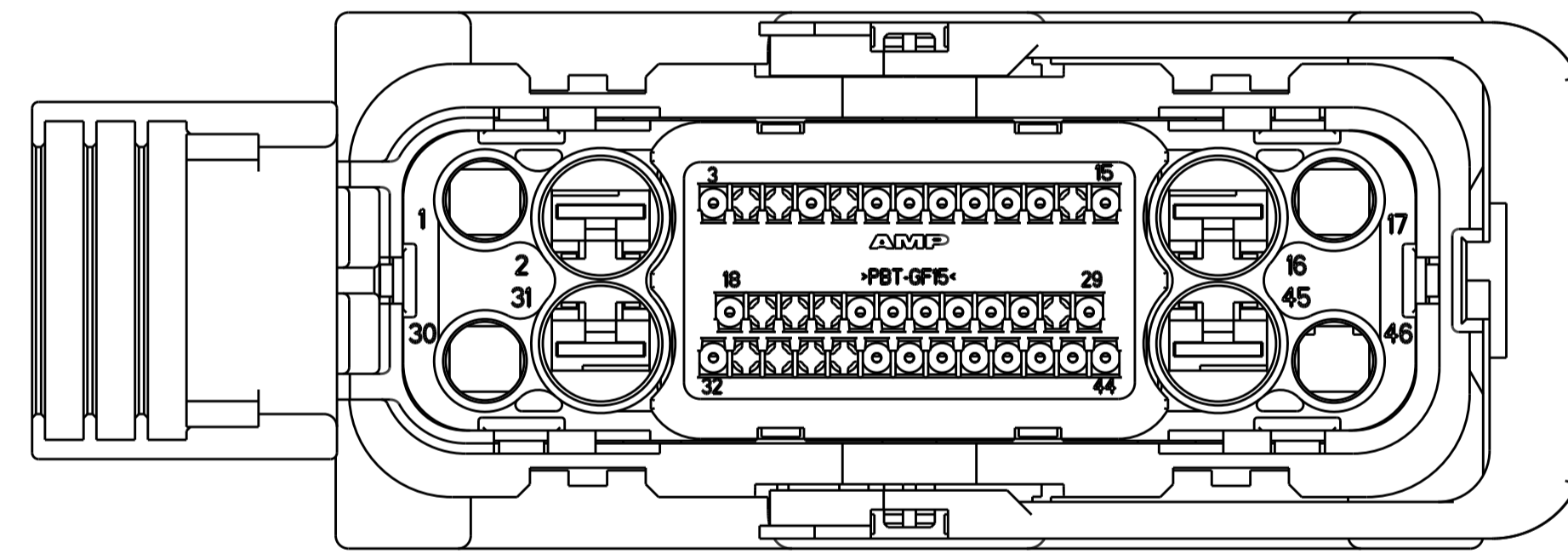

1-1326338-4
SCALE 2:1

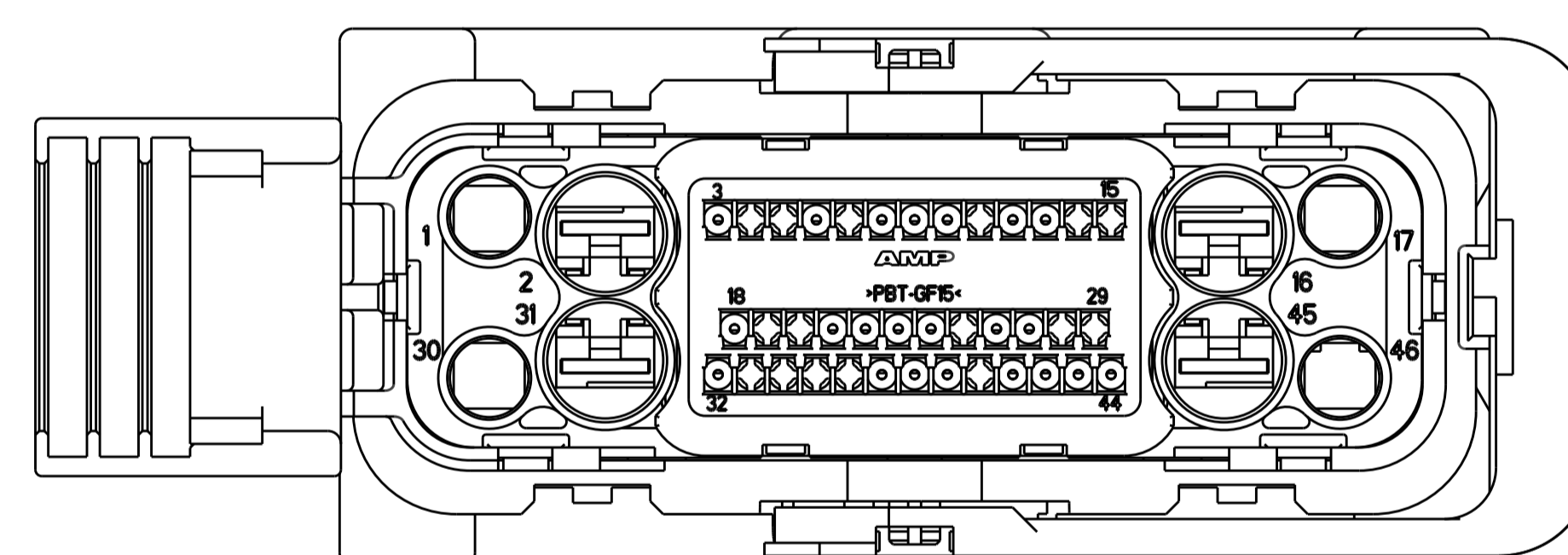

1-1326338-5
SCALE 2:1

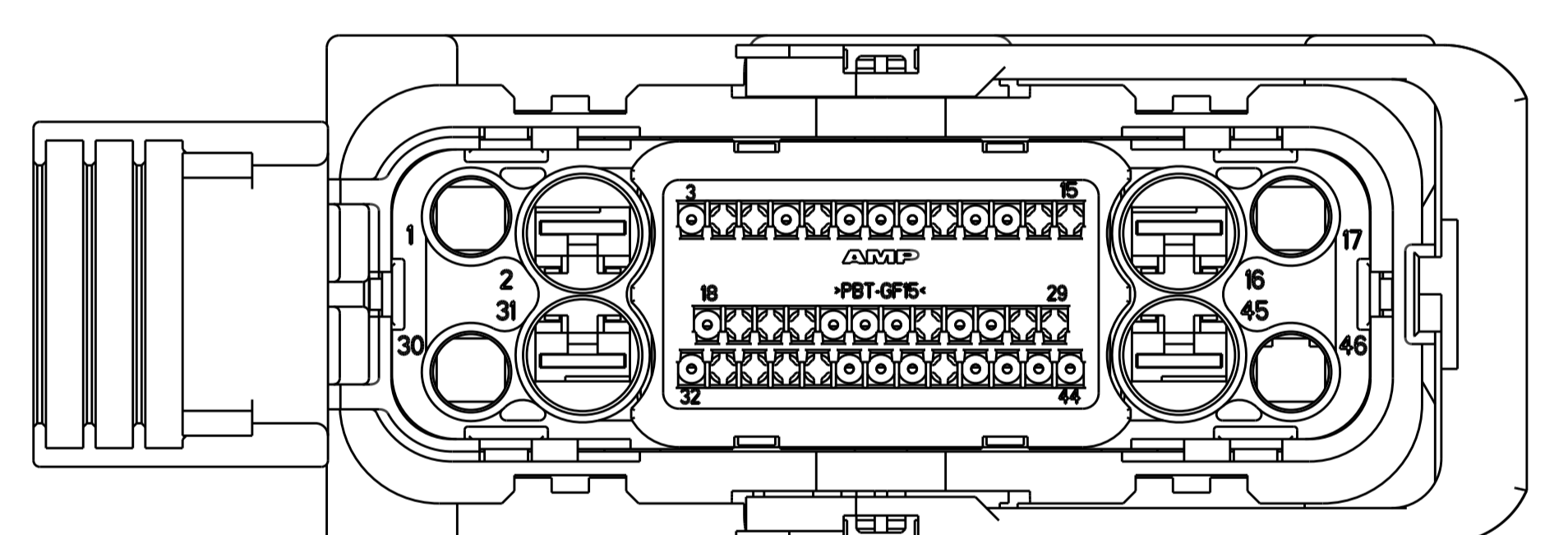

1-1326338-6
SCALE 2:1

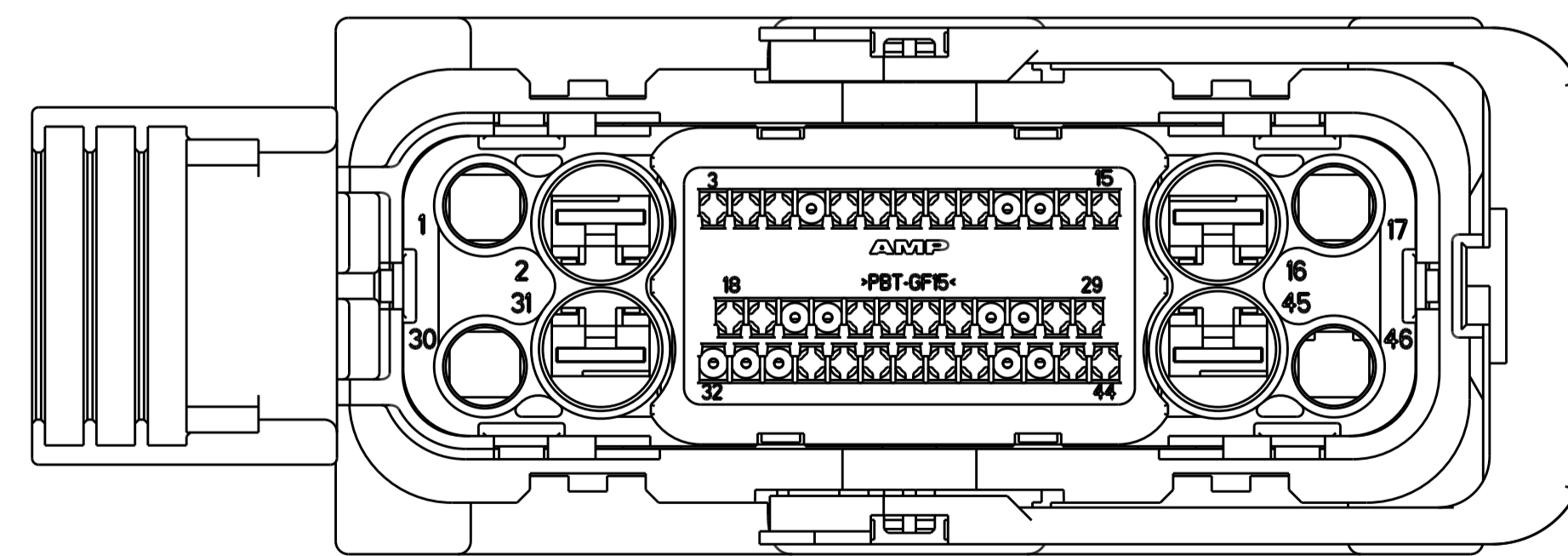

2-1326338-0
SCALE 2:1

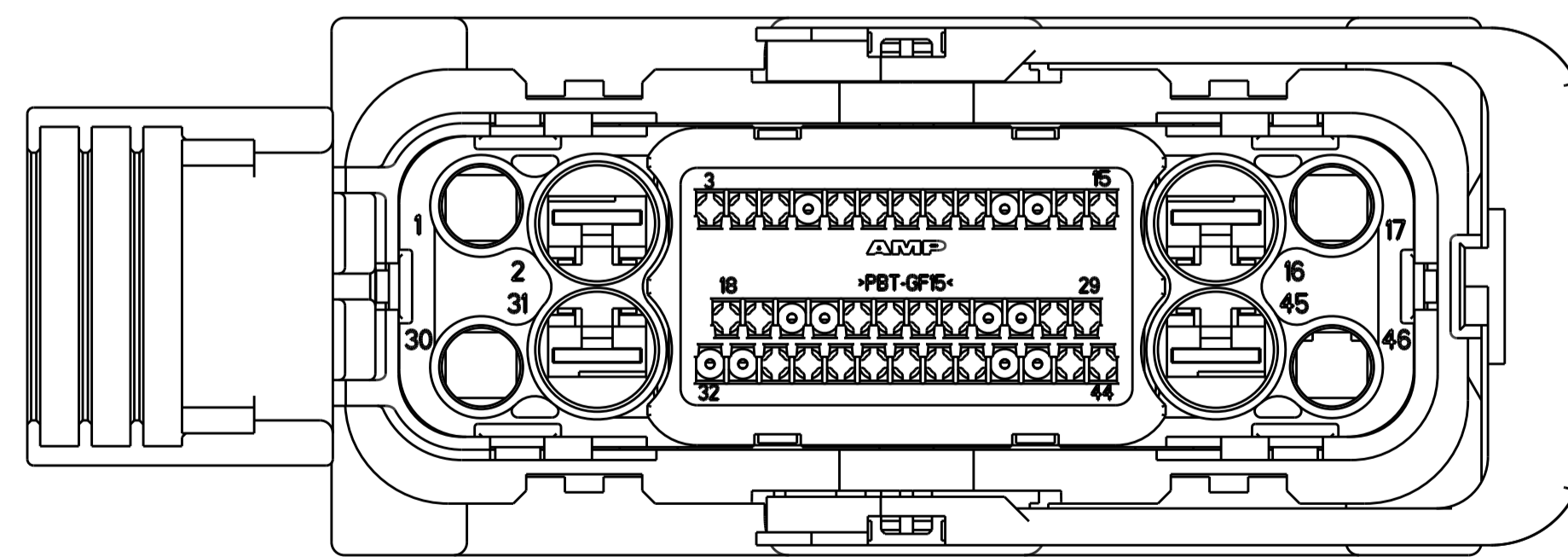

2-1326338-1
SCALE 2:1

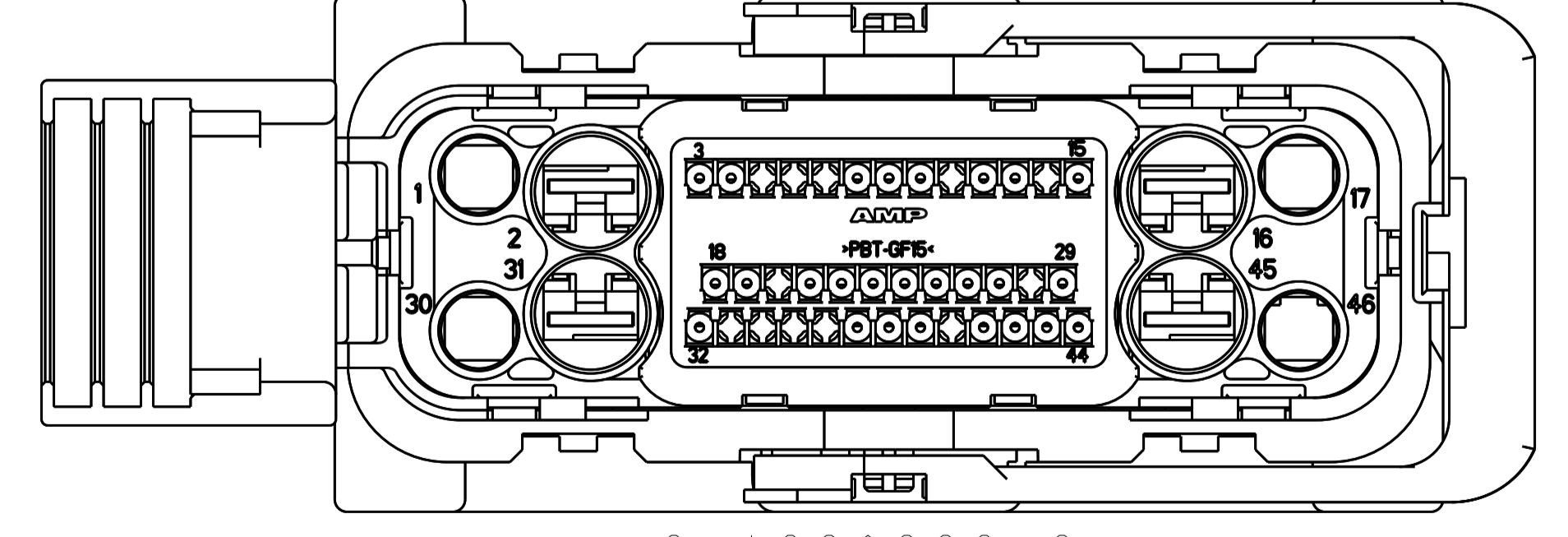

2-1326338-2
SCALE 2:1

THIS DRAWING IS A CONTROLLED DOCUMENT.		OWN A. HOLT 01APR2003	TE Connectivity DRAWING MATRIX 46 POSITION EBC-440 PLUG ASSEMBLY
DIMENSIONS:		CHK J. TONEY 01APR2003	
mm	TOLERANCES UNLESS OTHERWISE SPECIFIED:	APVD J. TONEY 01APR2003	NAME
	0 PLC ±	PRODUCT SPEC	SIZE
	1 PLC ±	APPLICATION SPEC	CAGE CODE
	2 PLC ±	WEIGHT	DRAWING NO
	3 PLC ±	Customer Drawing	RESTRICTED TO
	4 PLC ±		A1 00779 ©=1326534
	ANGLES ±		SCALE NONE SHEET 8 OF 12 REV AF7
MATERIAL	FINISH		

LOC		DIST		REVISIONS			
GP	00	P	LYR	DESCRIPTION	DATE	DWN	APVD
				SEE SHEET 1			

PINOUT CONFIGURATION GEOMETRY

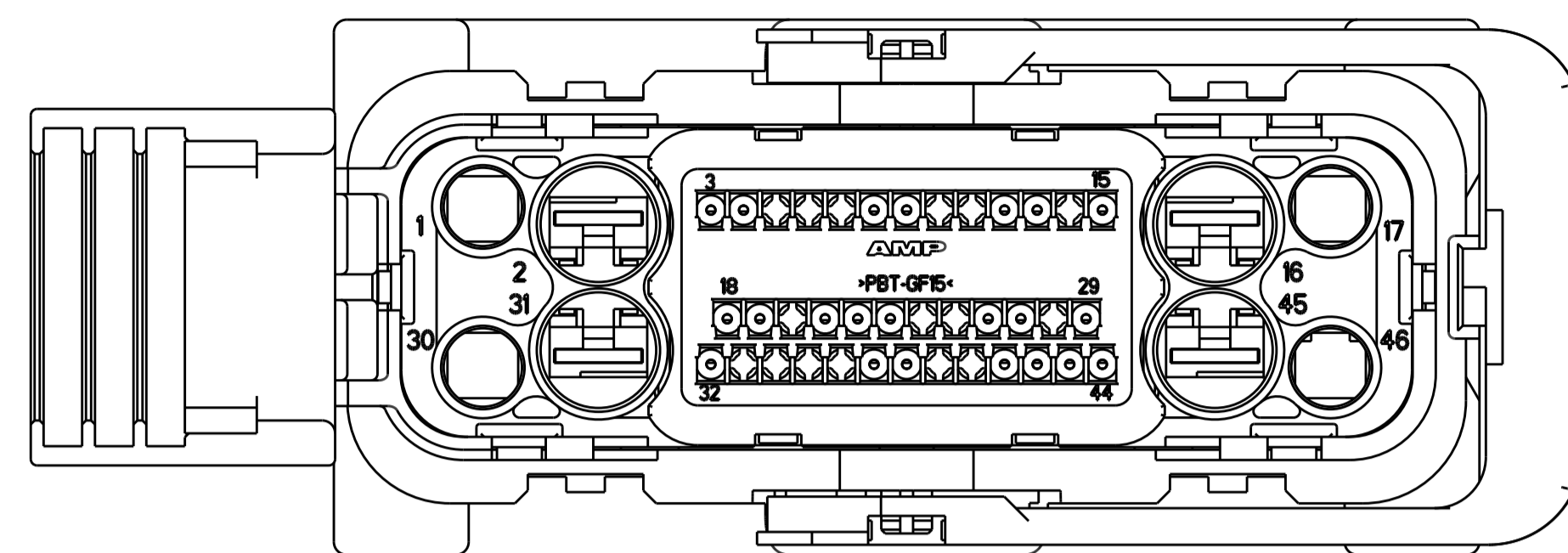

2-1326338-3
SCALE 2:1

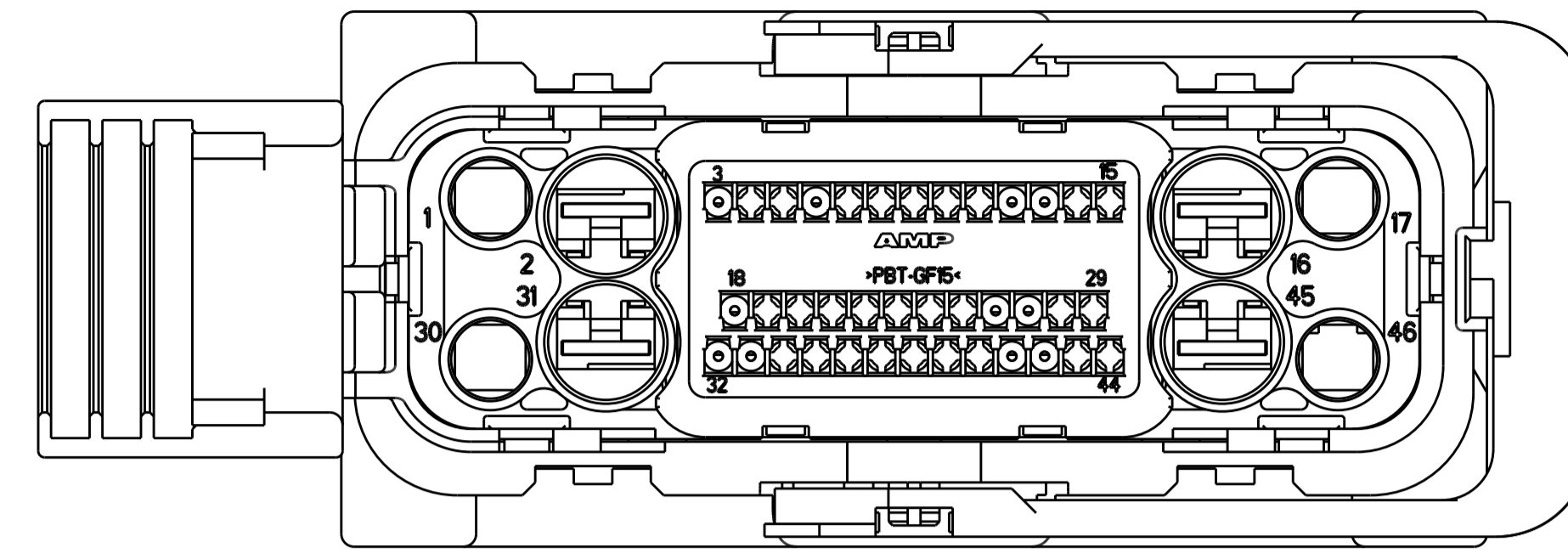

2-1326338-4
SCALE 2:1

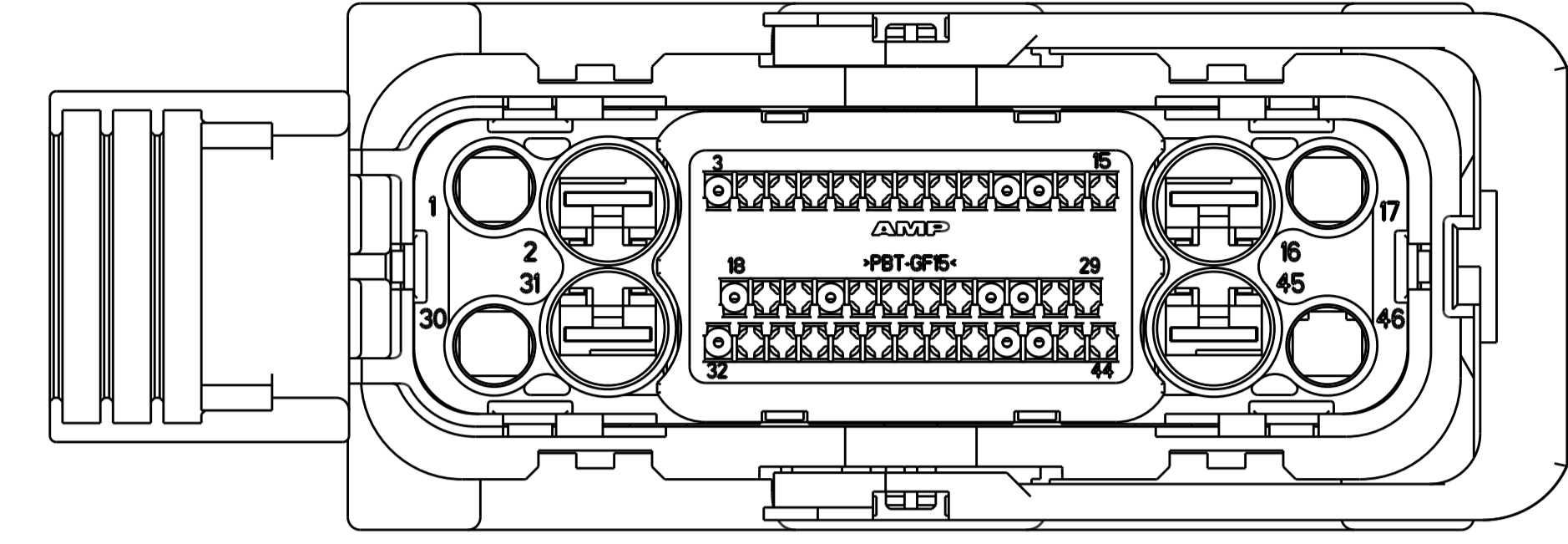

2-1326338-5
SCALE 2:1

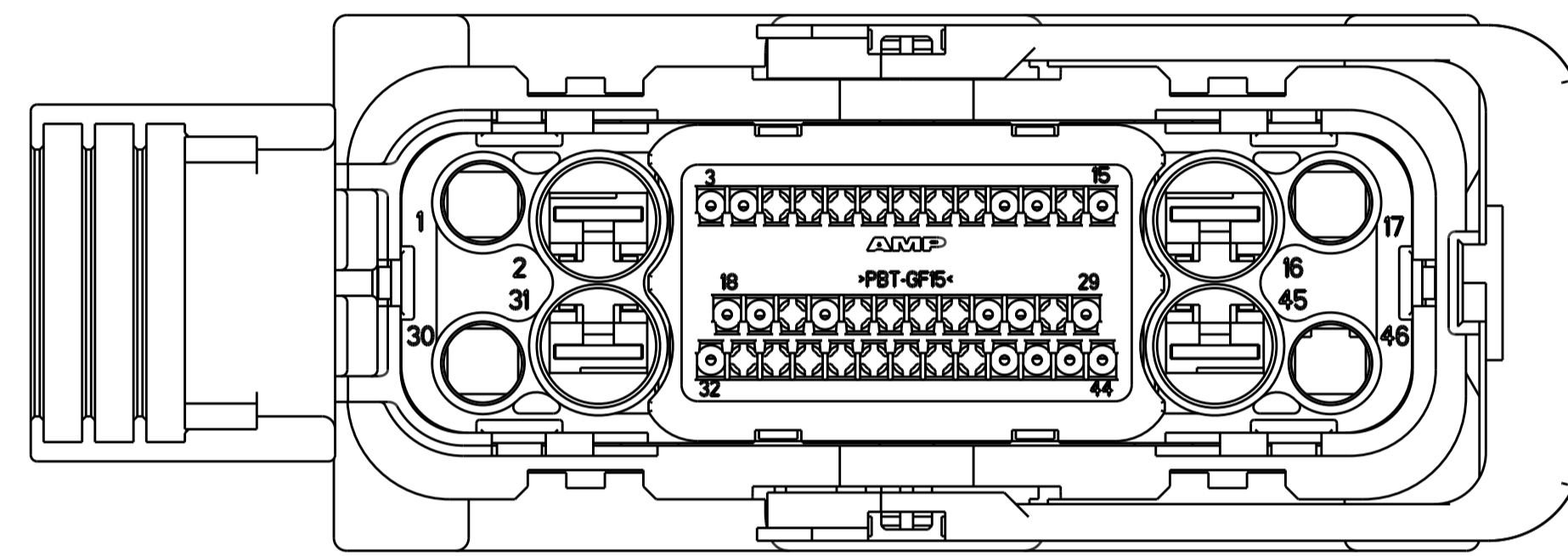

2-1326338-9
SCALE 2:1

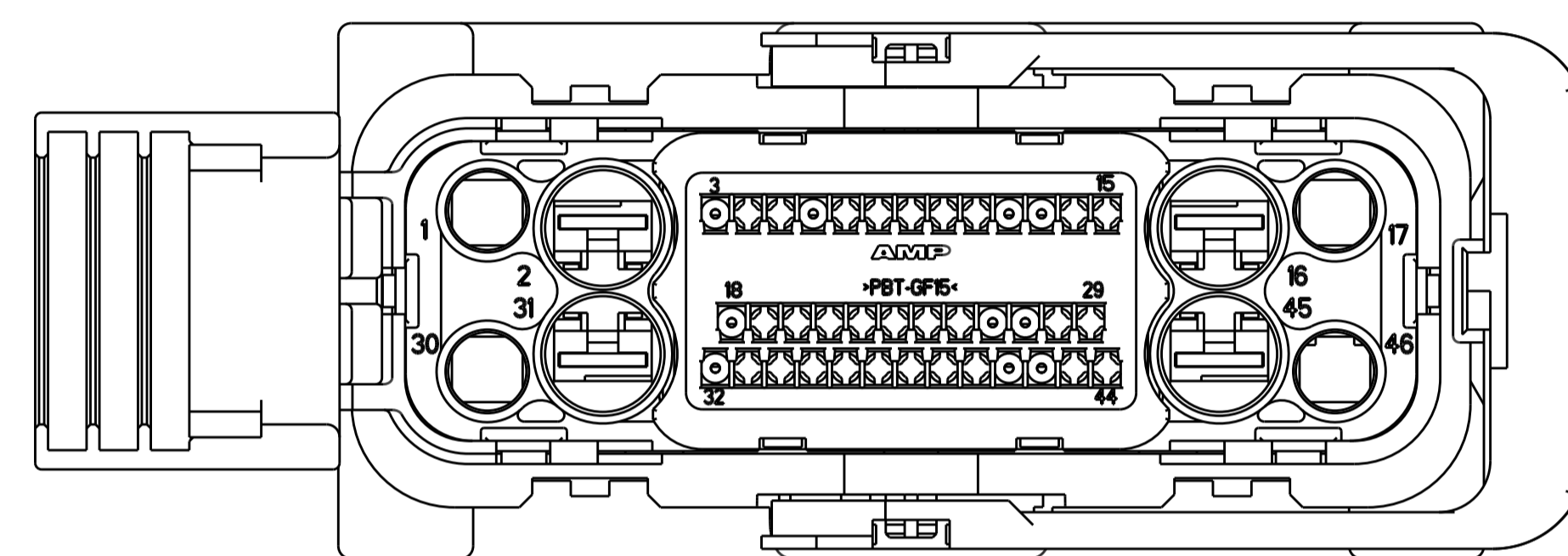

3-1326338-0
SCALE 2:1

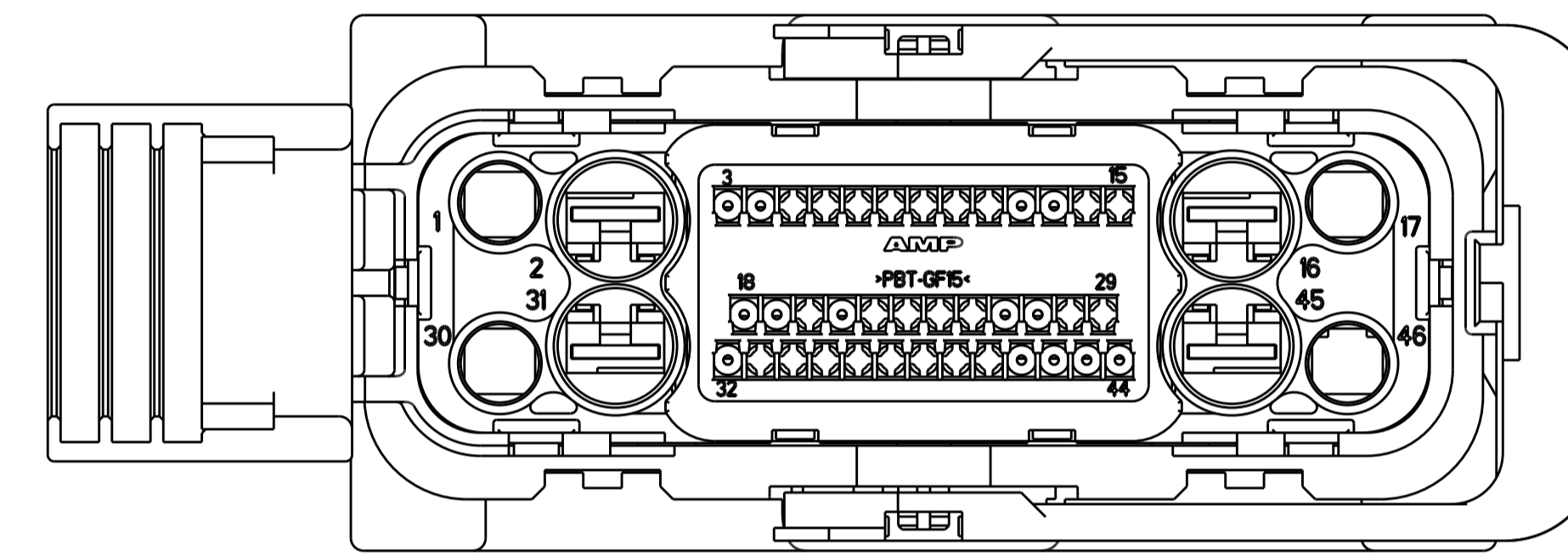

3-1326338-1
SCALE 2:1

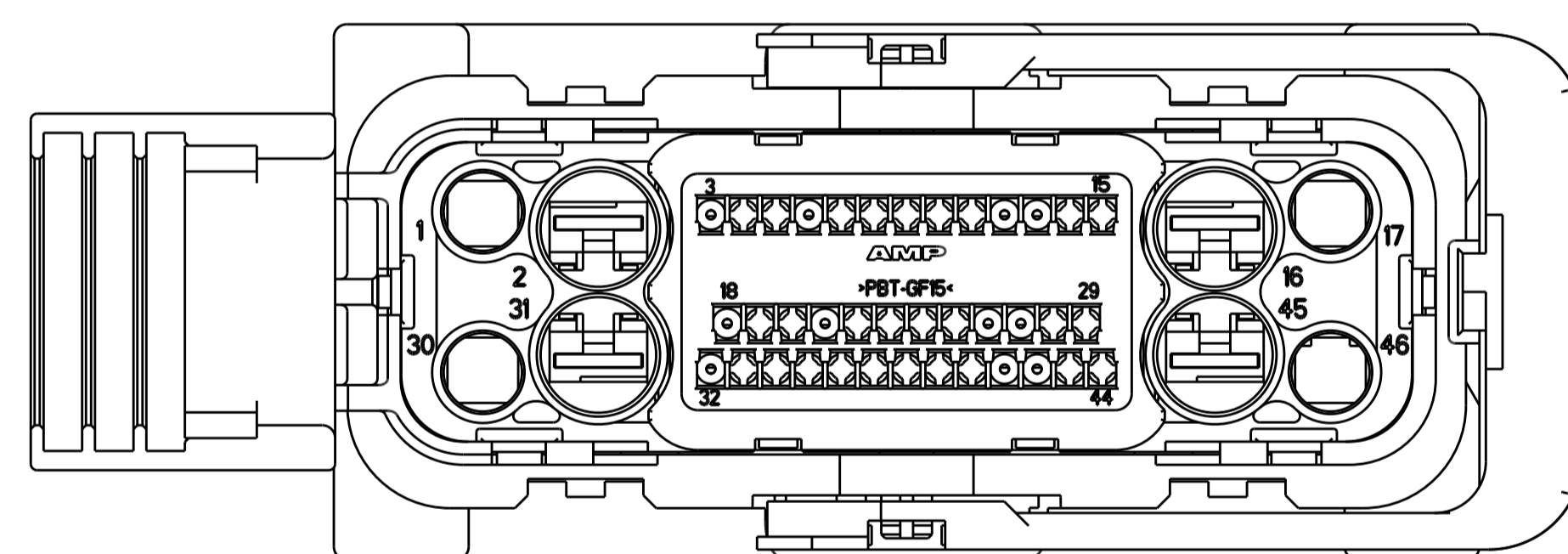

3-1326338-3
SCALE 2:1

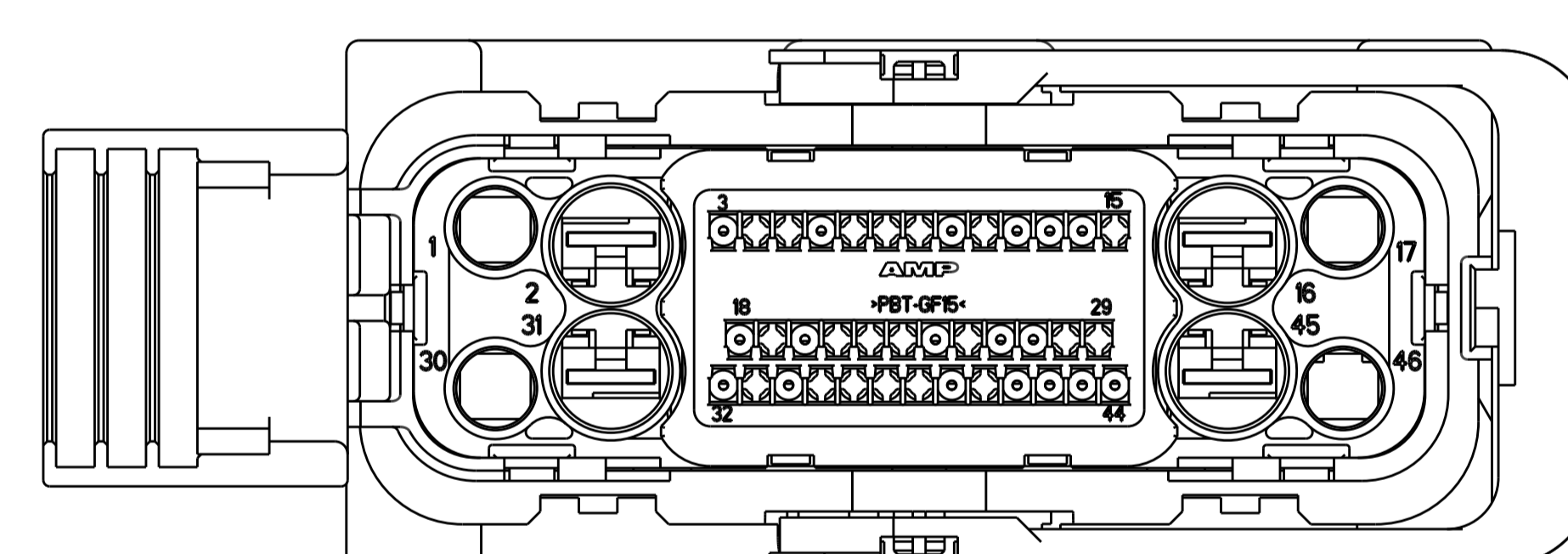

3-1326338-8
SCALE 2:1

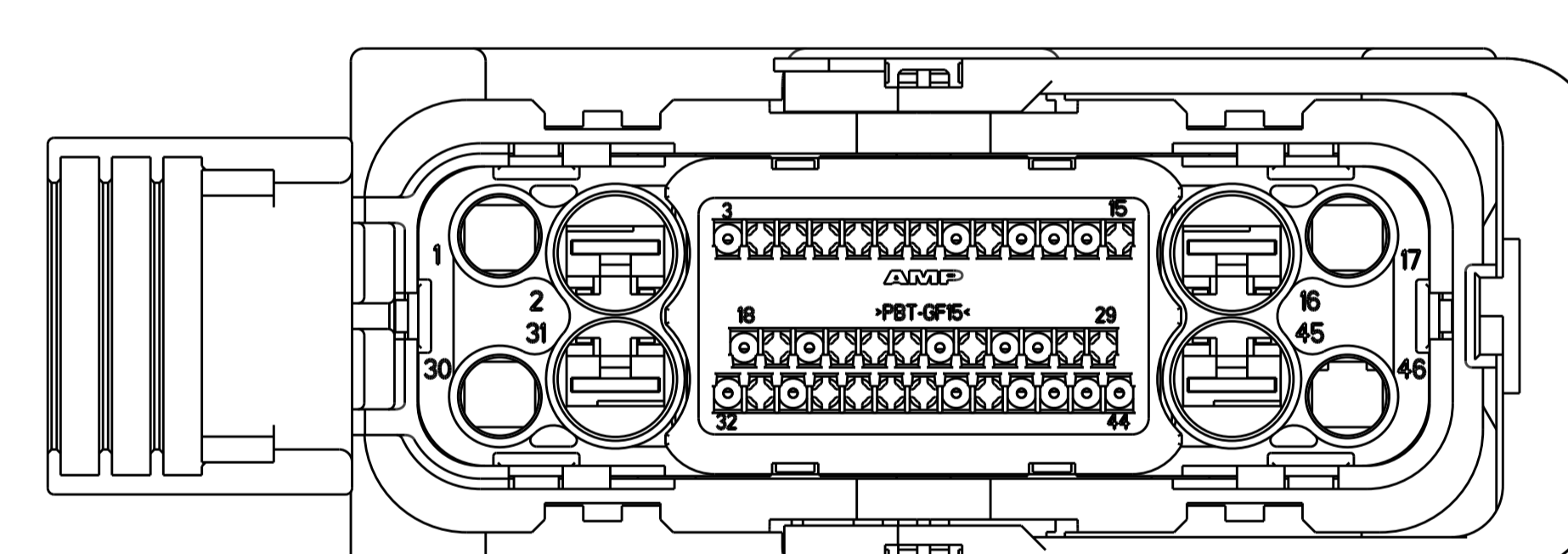

4-1326338-0
SCALE 2:1

THIS DRAWING IS A CONTROLLED DOCUMENT.		DWN A. HOLT 01APR2003	 TE Connectivity DRAWING MATRIX 46 POSITION EBC-440 PLUG ASSEMBLY
DIMENSIONS:		CHK J. TONEY 01APR2003	
mm		APVD J. TONEY 01APR2003	
TOLERANCES UNLESS OTHERWISE SPECIFIED: 0 PLC ± 1 PLC ± 2 PLC ± 3 PLC ± 4 PLC ± ANGLES ±		PRODUCT SPEC APPLICATION SPEC SIZE CAGE CODE DRAWING NO A1 00779 ©=1326534	
MATERIAL		FINISH	RESTRICTED TO Customer Drawing SCALE NONE SHEET 9 OF 12 REV AF7

PINOUT CONFIGURATION GEOMETRY

LOC	DIST	REV	DATE	BY	APPD
GP	00				
REVISIONS		DESCRIPTION	DATE	BY	APPD
		SEE SHEET 1			

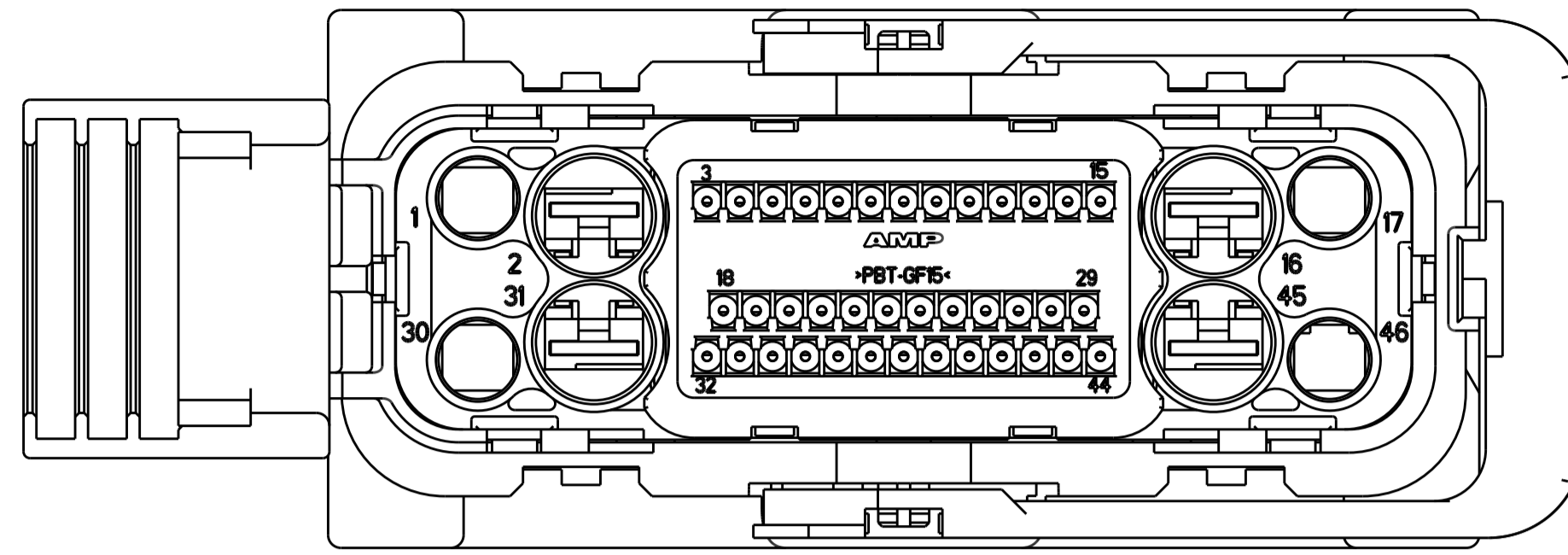

1326339-1
SCALE 2:1

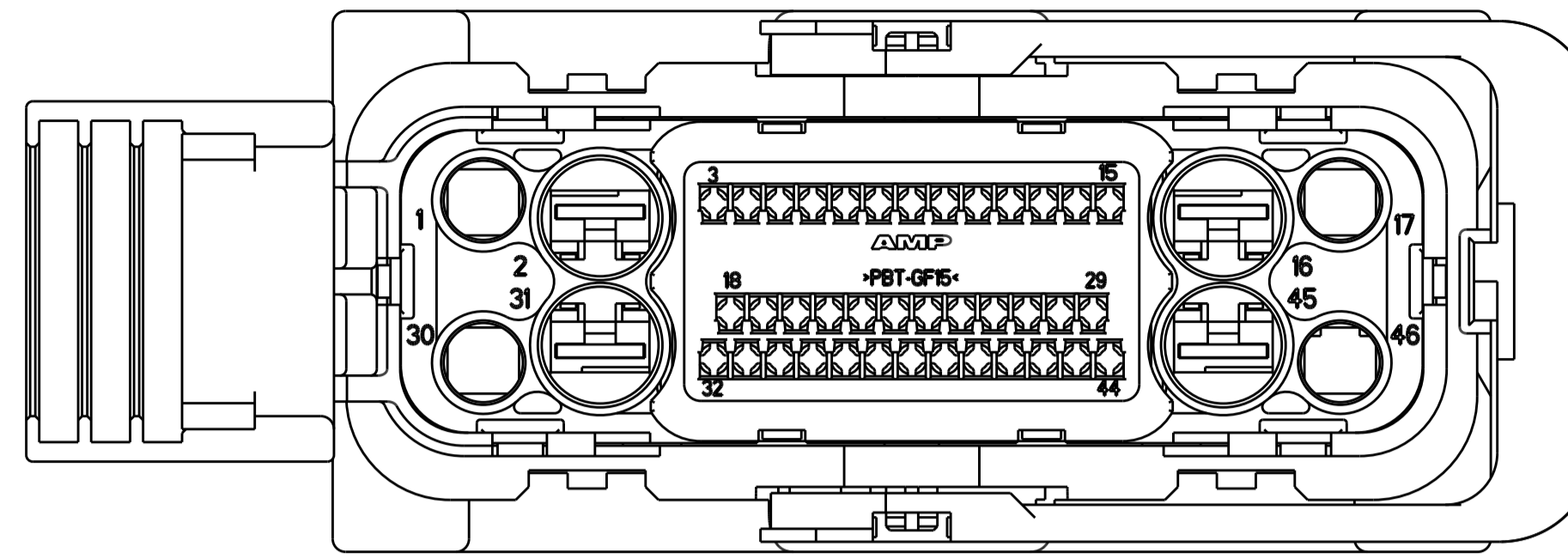

1326339-2
SCALE 2:1

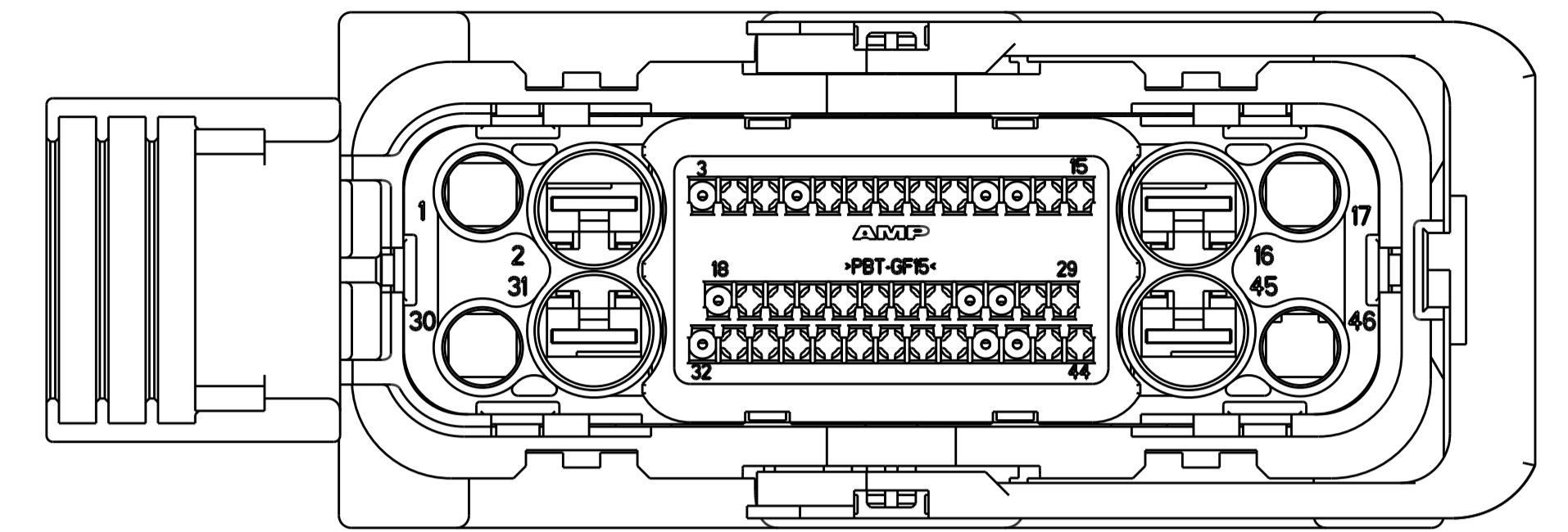

1326339-3
SCALE 2:1

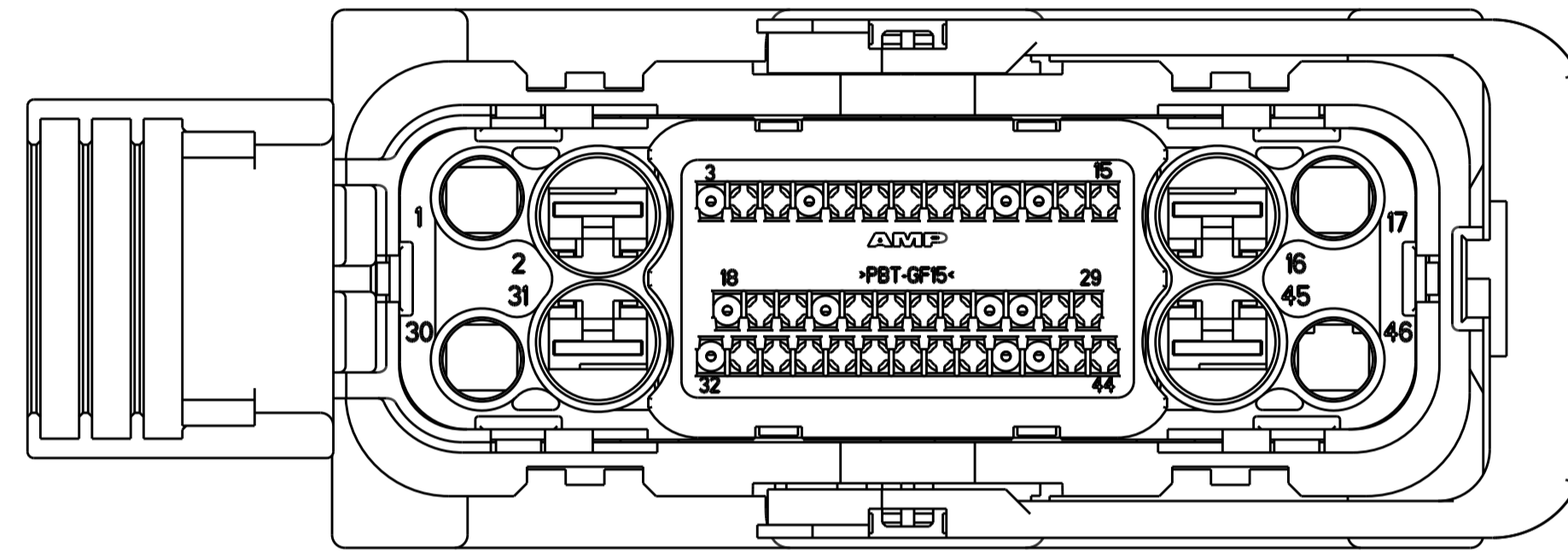

1326339-4
SCALE 2:1

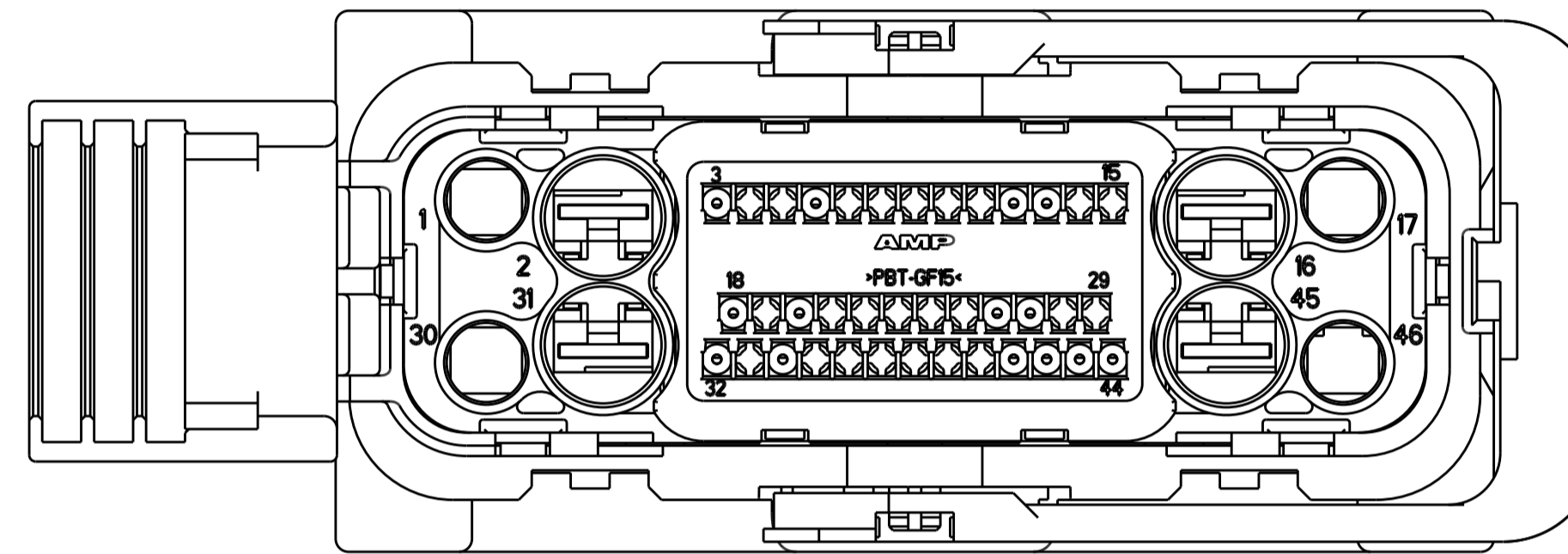

1326339-5
SCALE 2:1

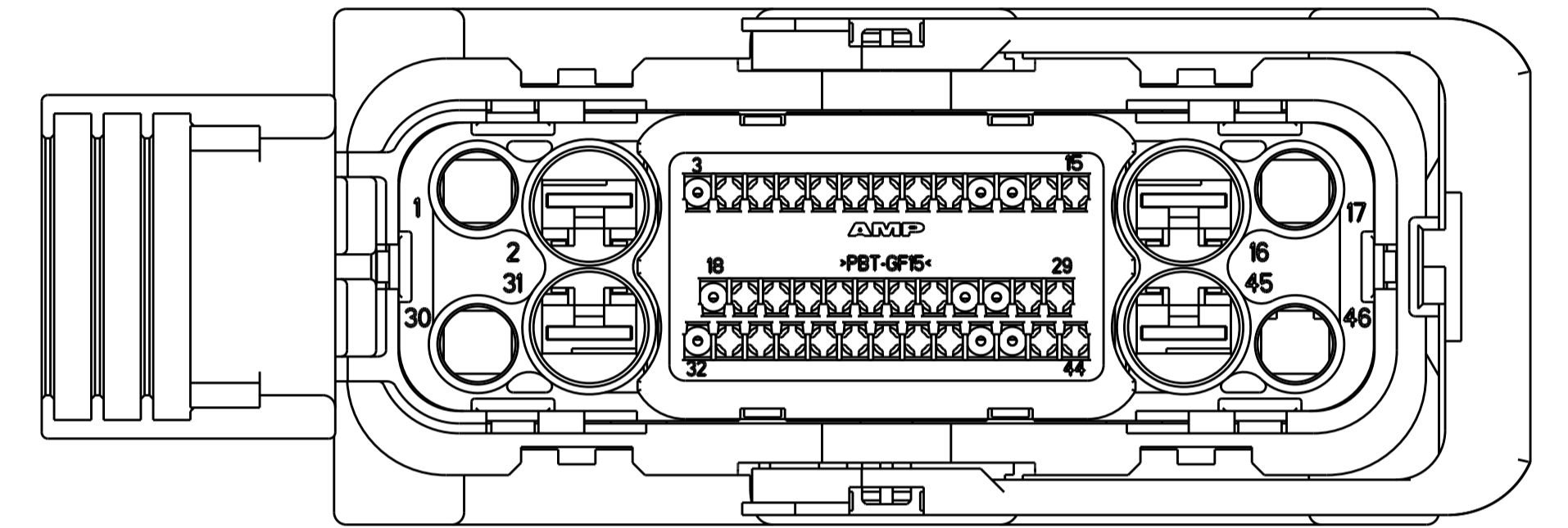

1326339-6
SCALE 2:1

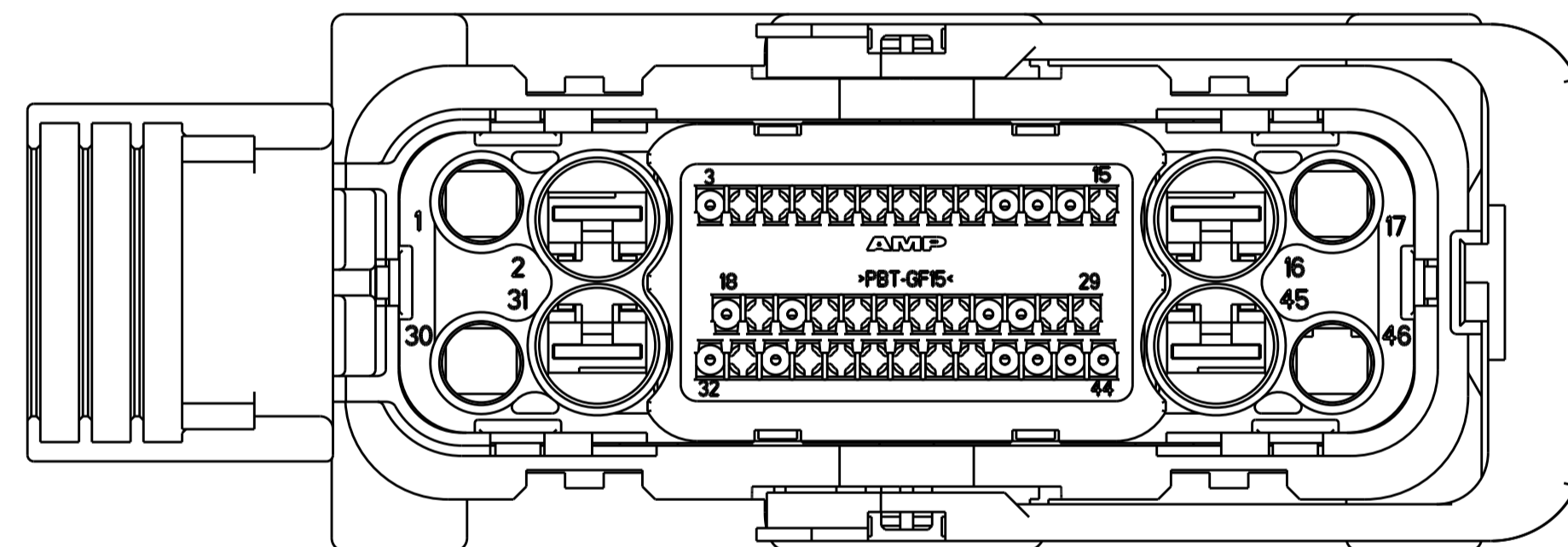

1326339-7
SCALE 2:1

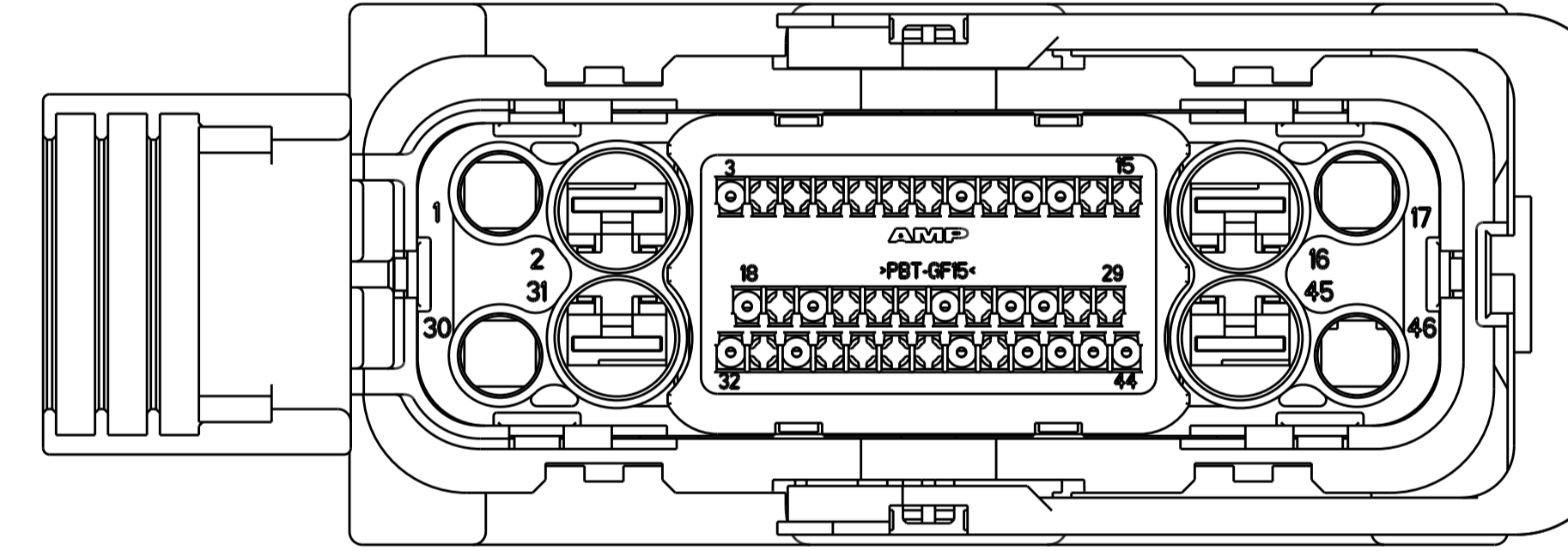

1326339-8
SCALE 2:1

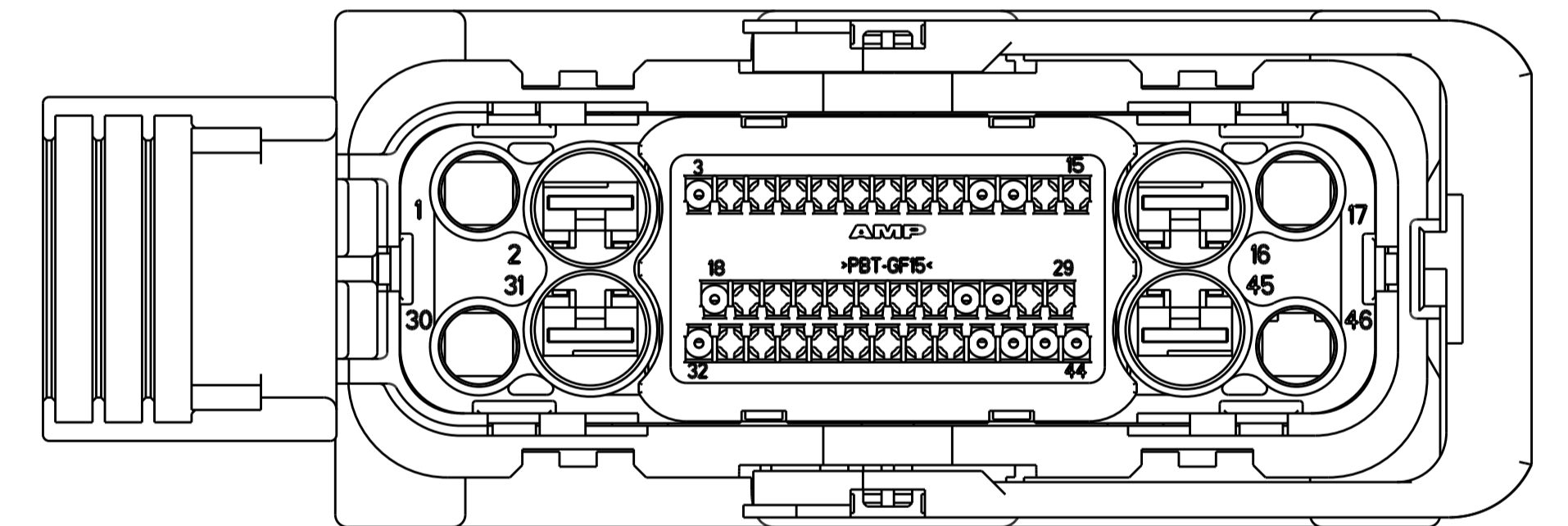

1326339-9
SCALE 2:1

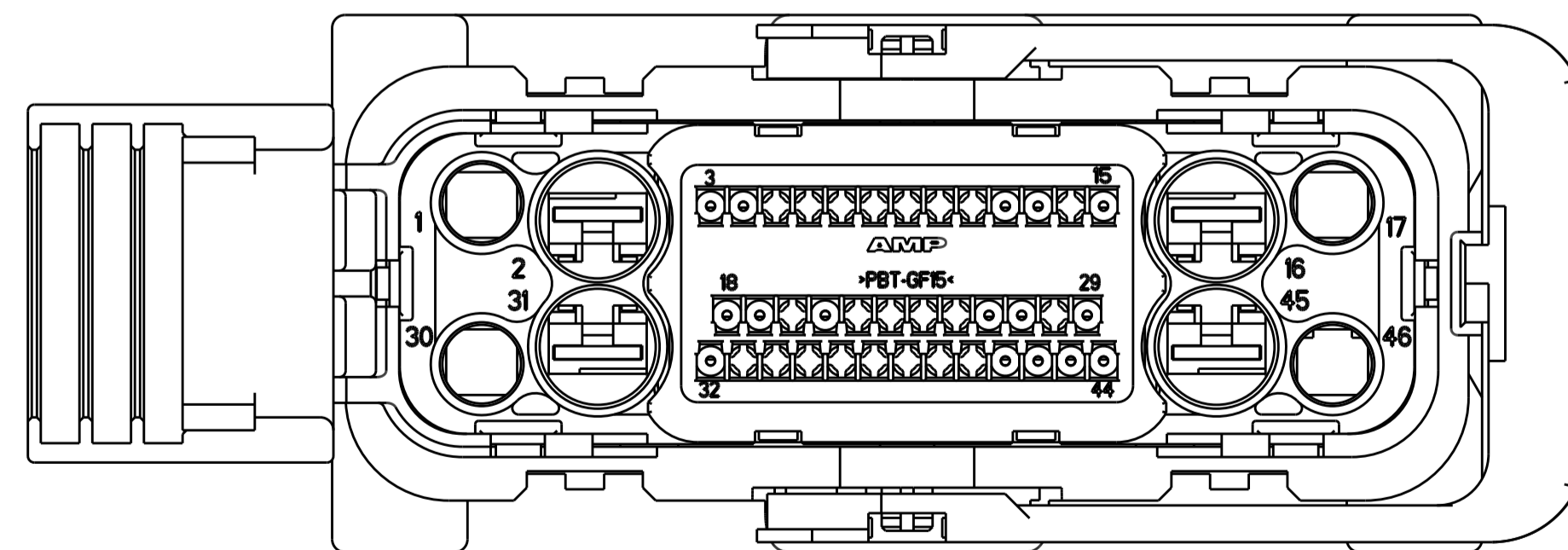

3-1326339-5
SCALE 2:1

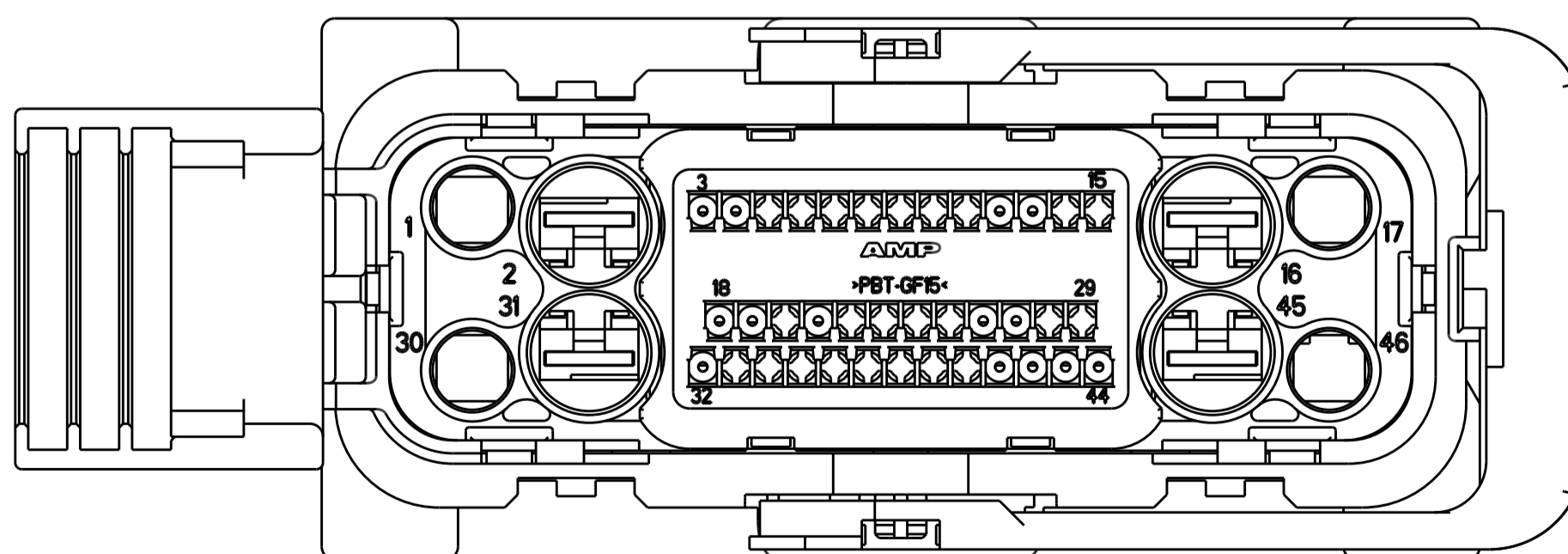

3-1326339-6
SCALE 2:1

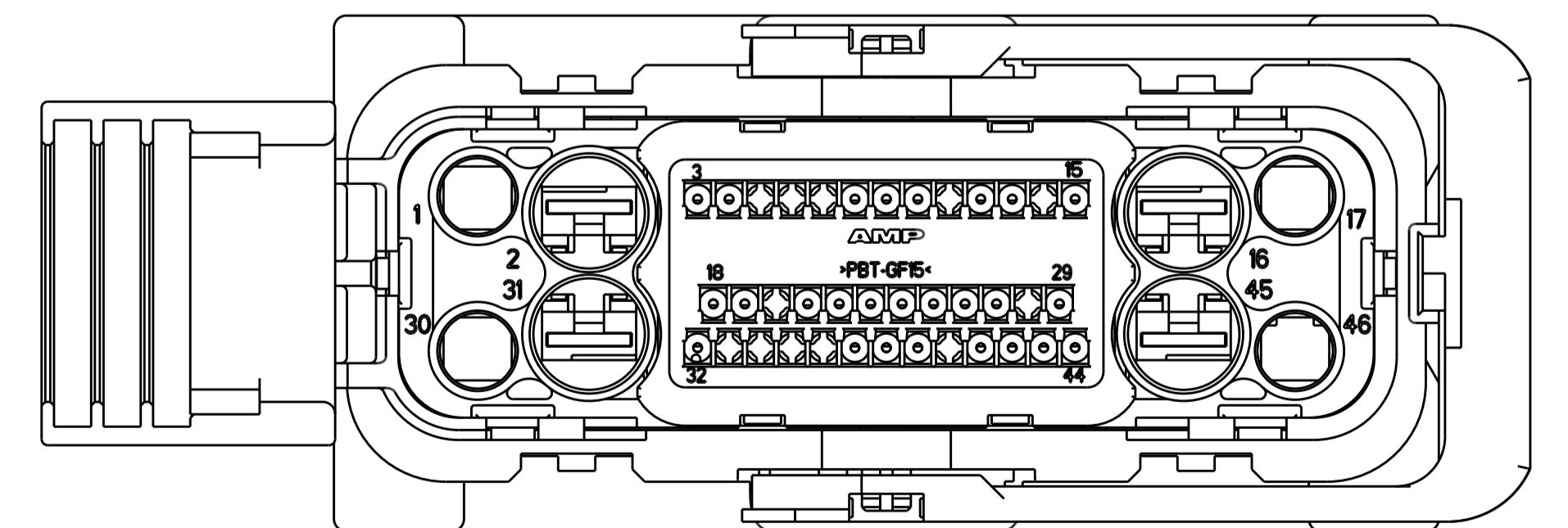

3-1326339-7
SCALE 2:1

THIS DRAWING IS A CONTROLLED DOCUMENT.		OWN: A. HOLT 01APR2003	
DIMENSIONS:		CHK: J. TONEY 01APR2003	
mm		APPD: J. TONEY 01APR2003	
		PRODUCT SPEC	
TOLERANCES UNLESS OTHERWISE SPECIFIED:		APPLICATION SPEC	NAME: DRAWING MATRIX
0 PLC ±		WEIGHT	46 POSITION
1 PLC ±		SIZE: A1	EBC-440 PLUG ASSEMBLY
2 PLC ±		CAGE CODE: 00779	RESTRICTED TO
3 PLC ±		DRAWING NO: 1326534	
4 PLC ±		Customer Drawing	
ANGLES ±		SCALE: NONE	
FINISH		SHEET: 10	
		OF: 12	
		REV: AF7	

LOC	DIST	REV	DATE	BY	APPV
GP	00				

REVISONS		DATE	BY	APPV
1	SEE SHEET 1			

PINOUT CONFIGURATION GEOMETRY

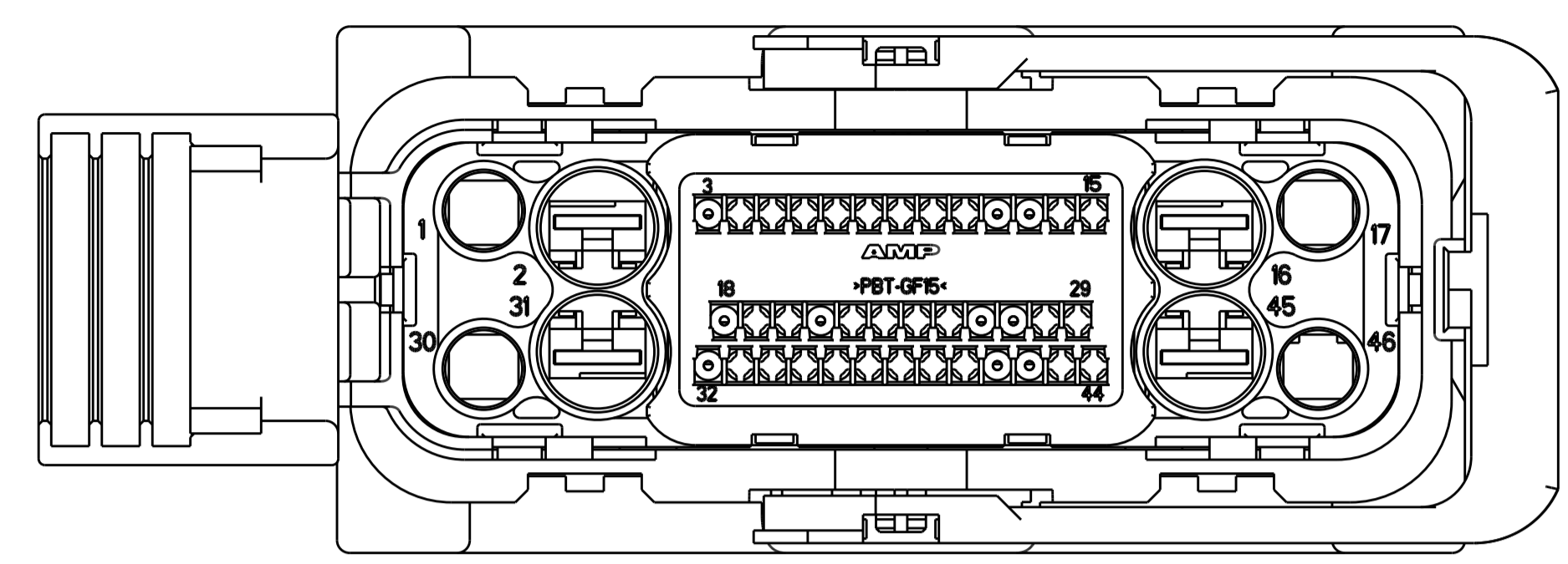

4-1326339-1
SCALE 2:1

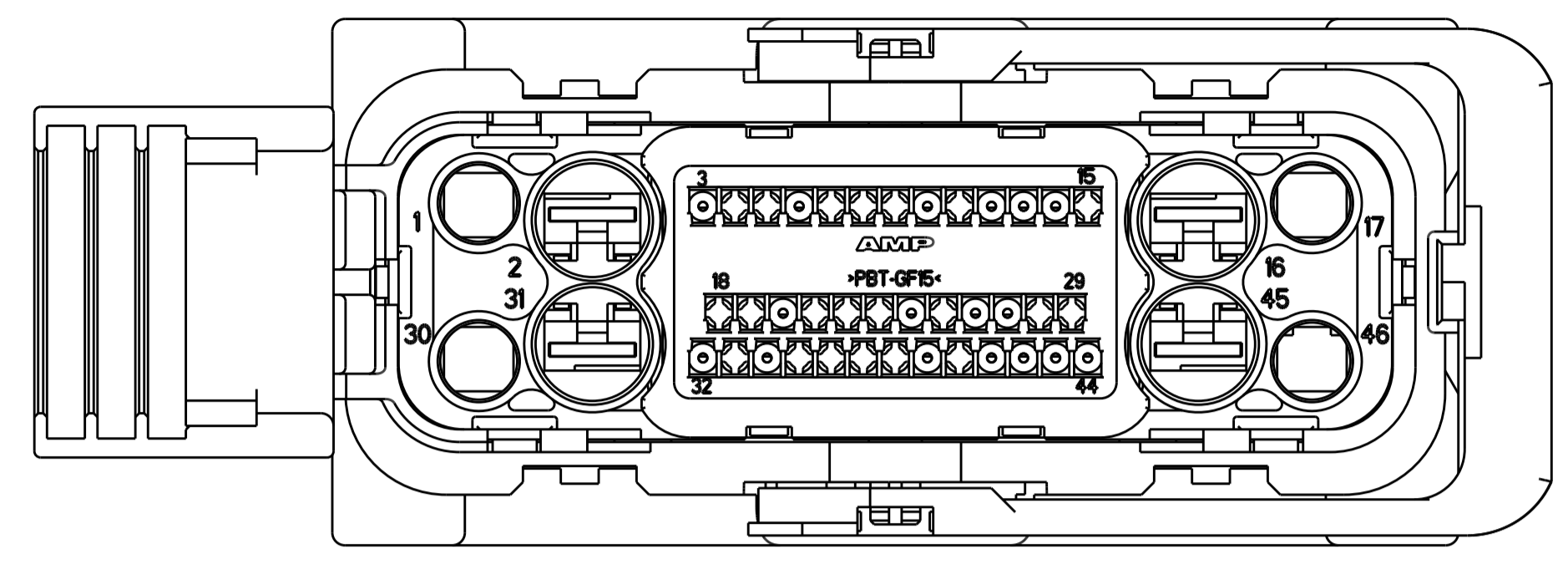

4-1326339-2
SCALE 2:1

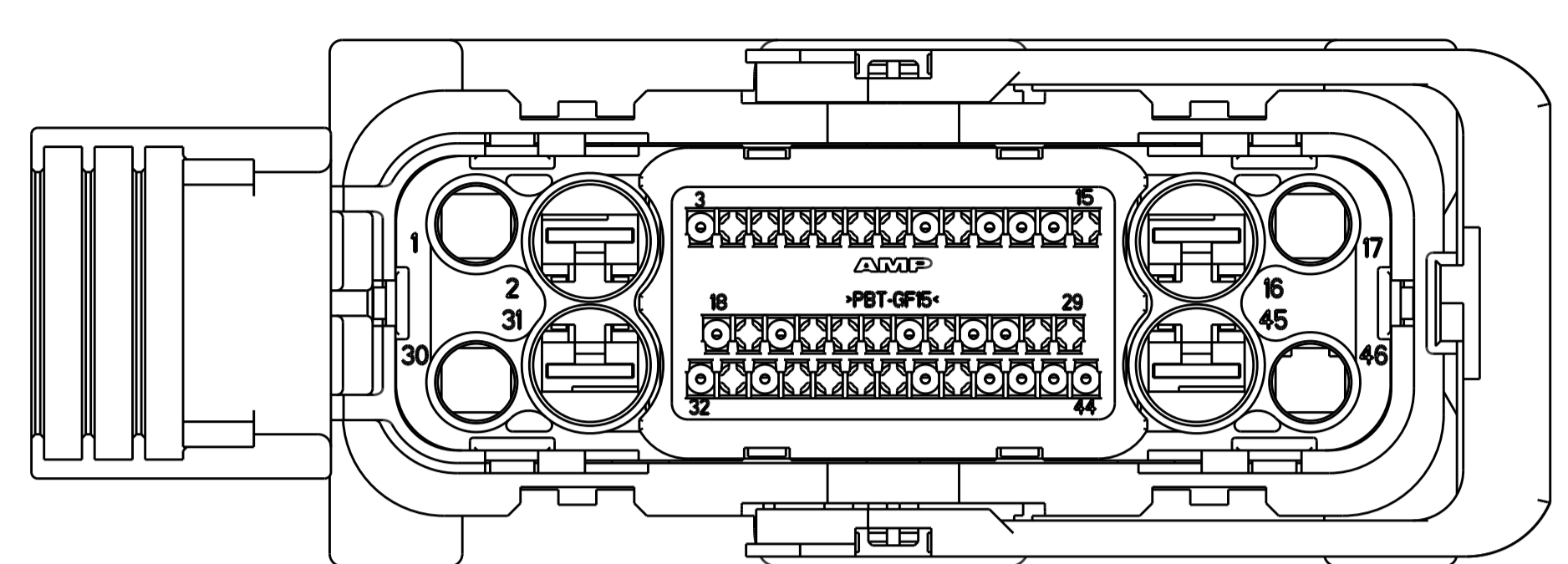

4-1326339-3
SCALE 2:1

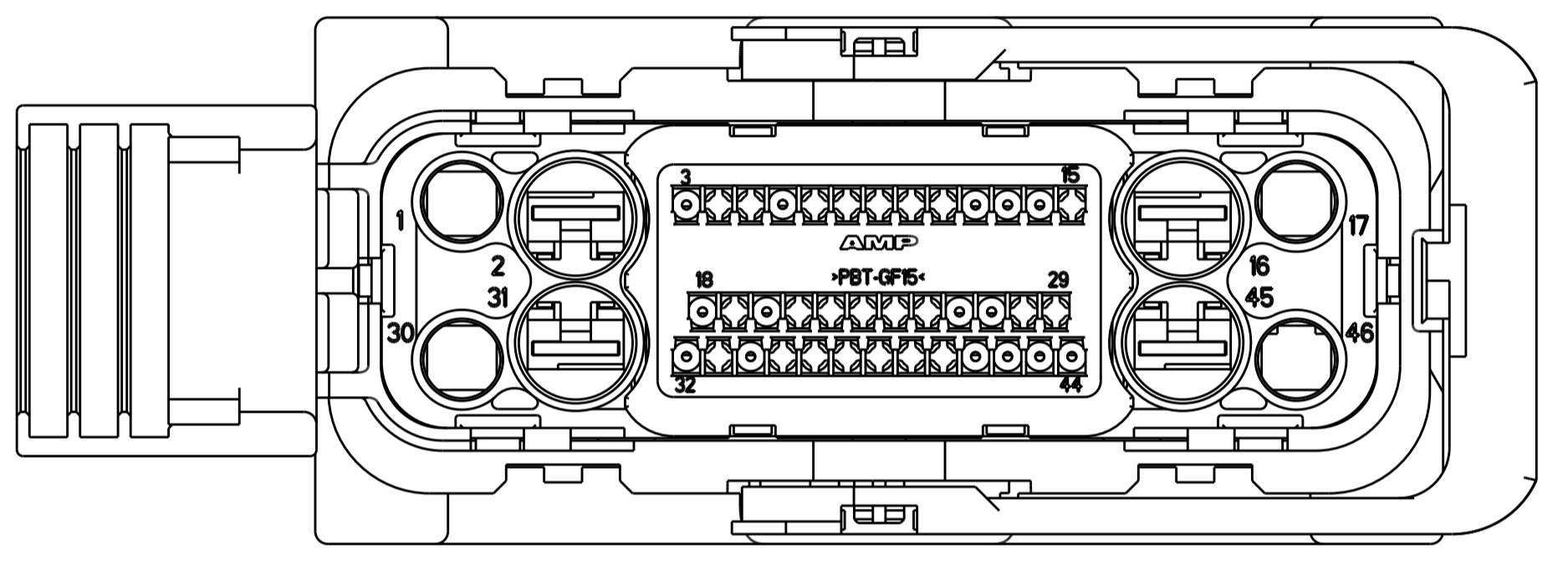

4-1326339-4
SCALE 2:1

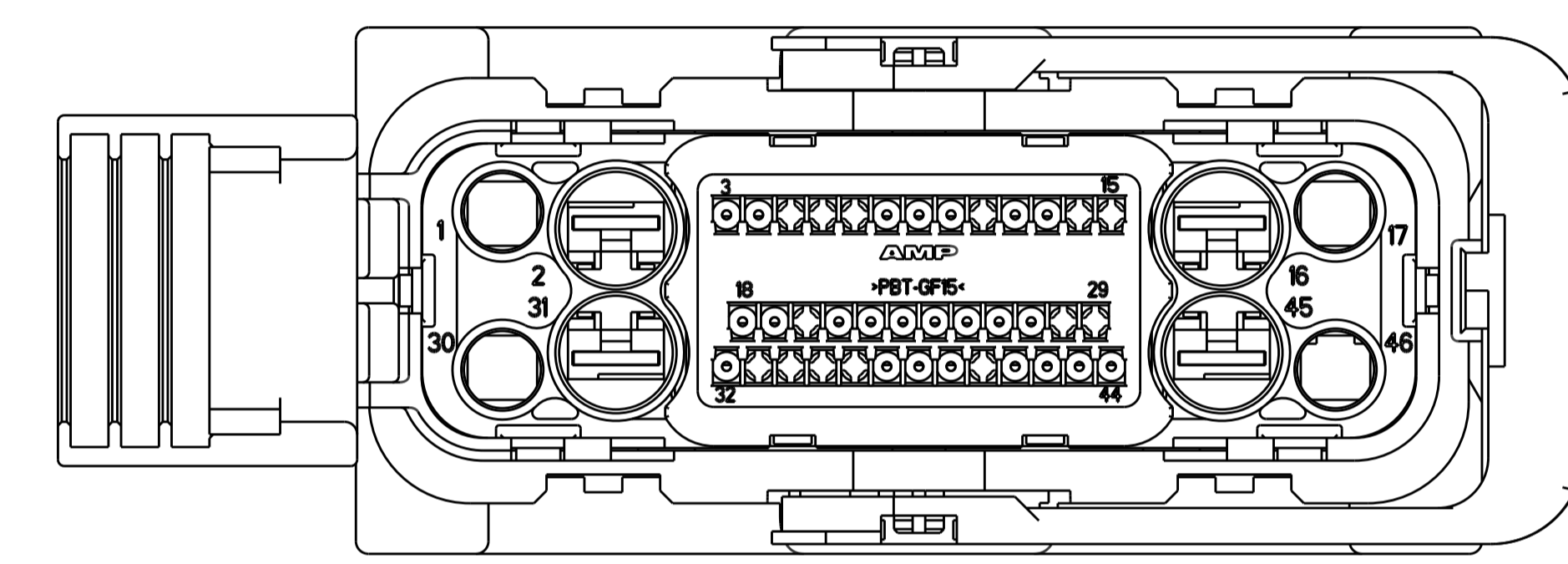

4-1326339-5
SCALE 2:1

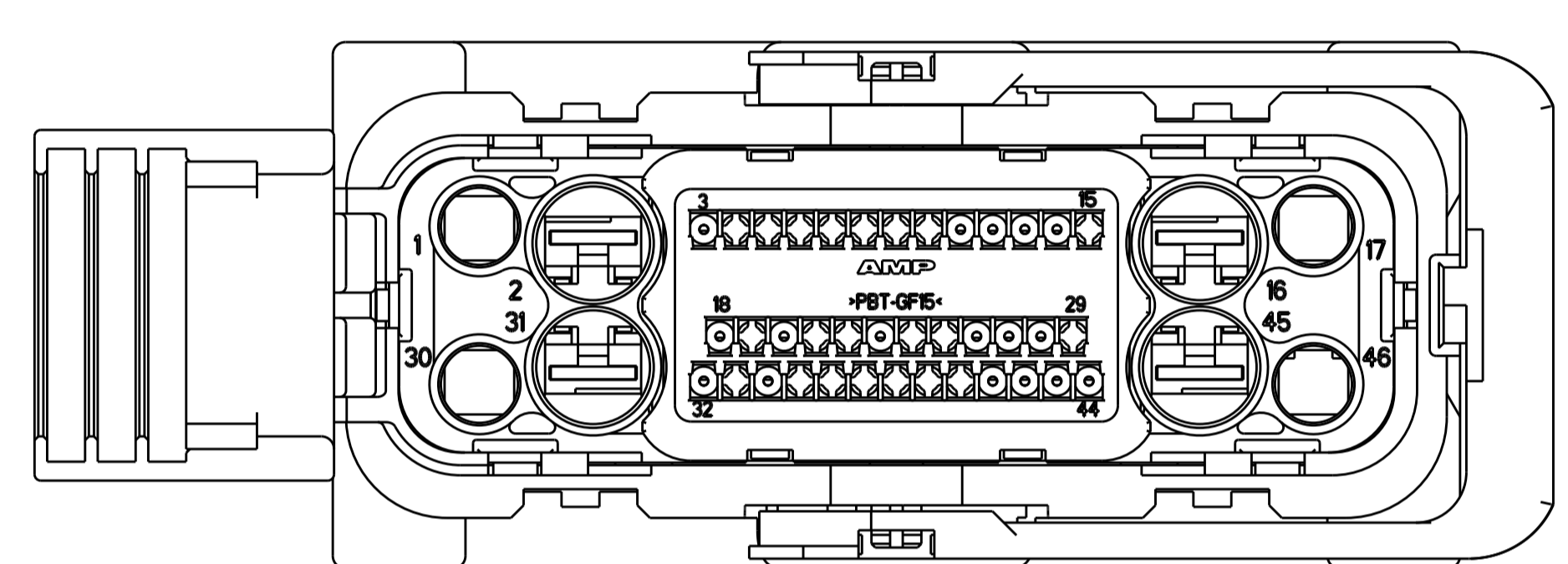

4-1326339-6
SCALE 2:1

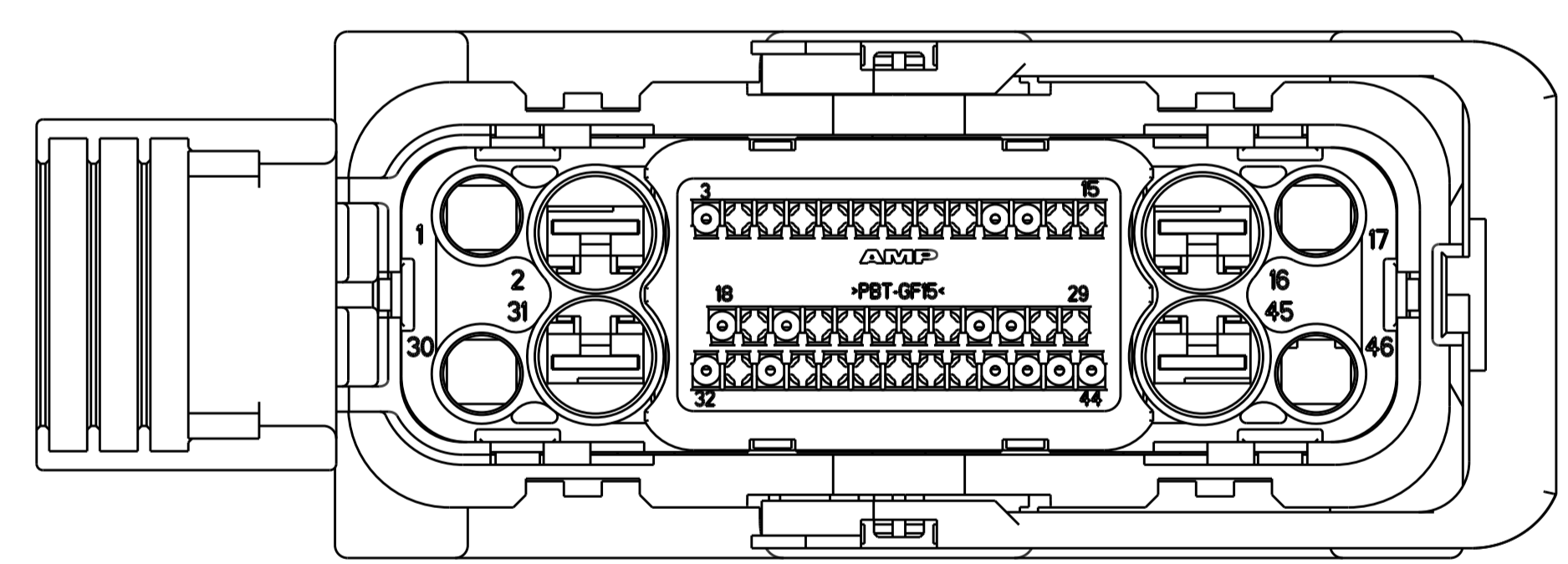

4-1326339-7
SCALE 2:1

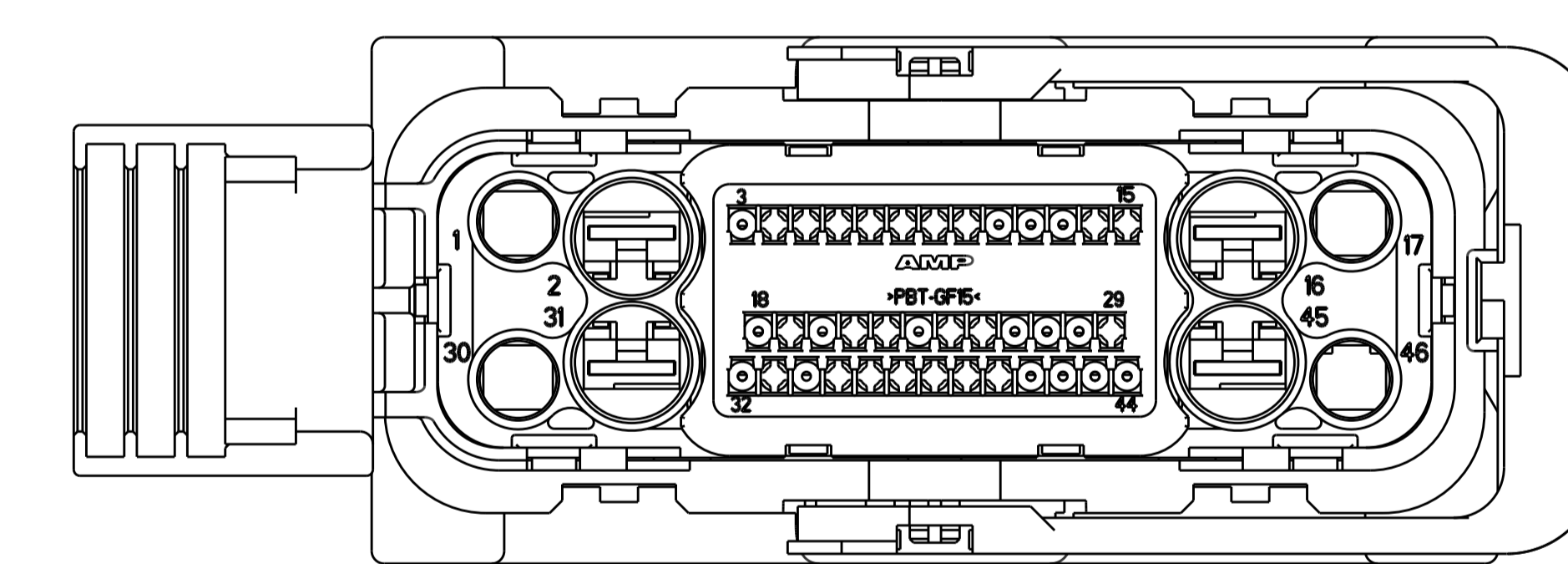

4-1326339-8
SCALE 2:1

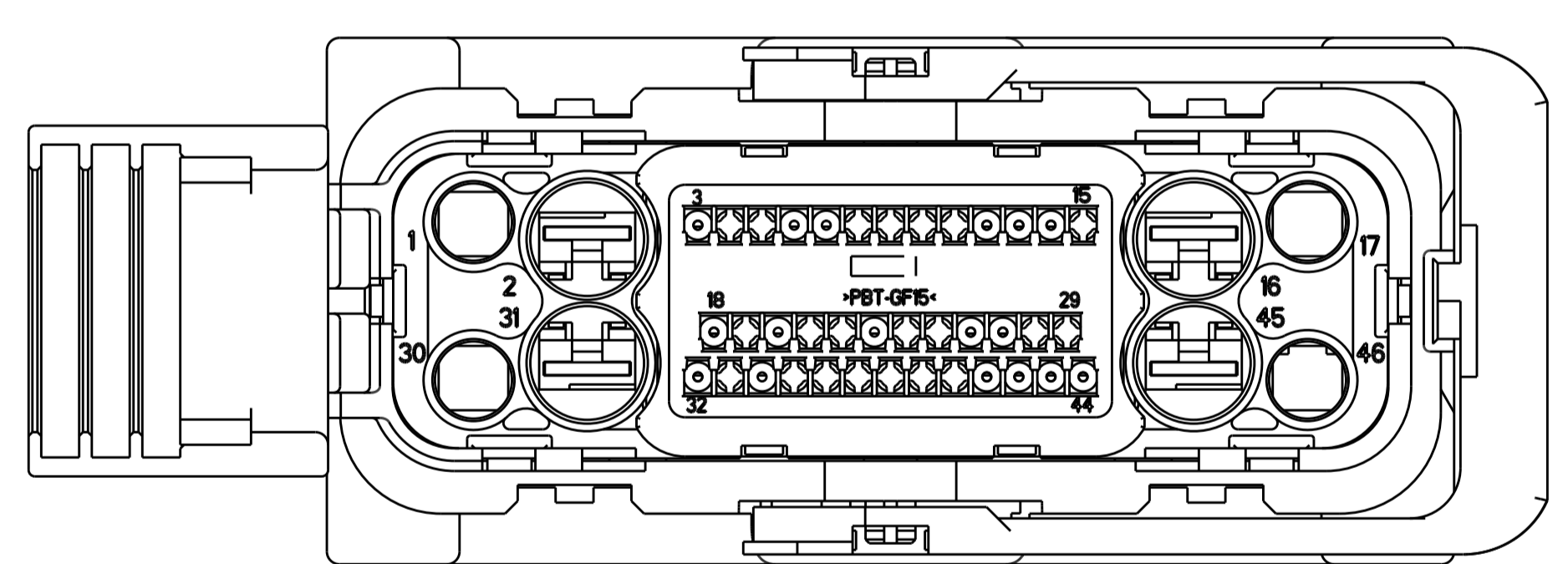

4-1326339-9
SCALE 2:1

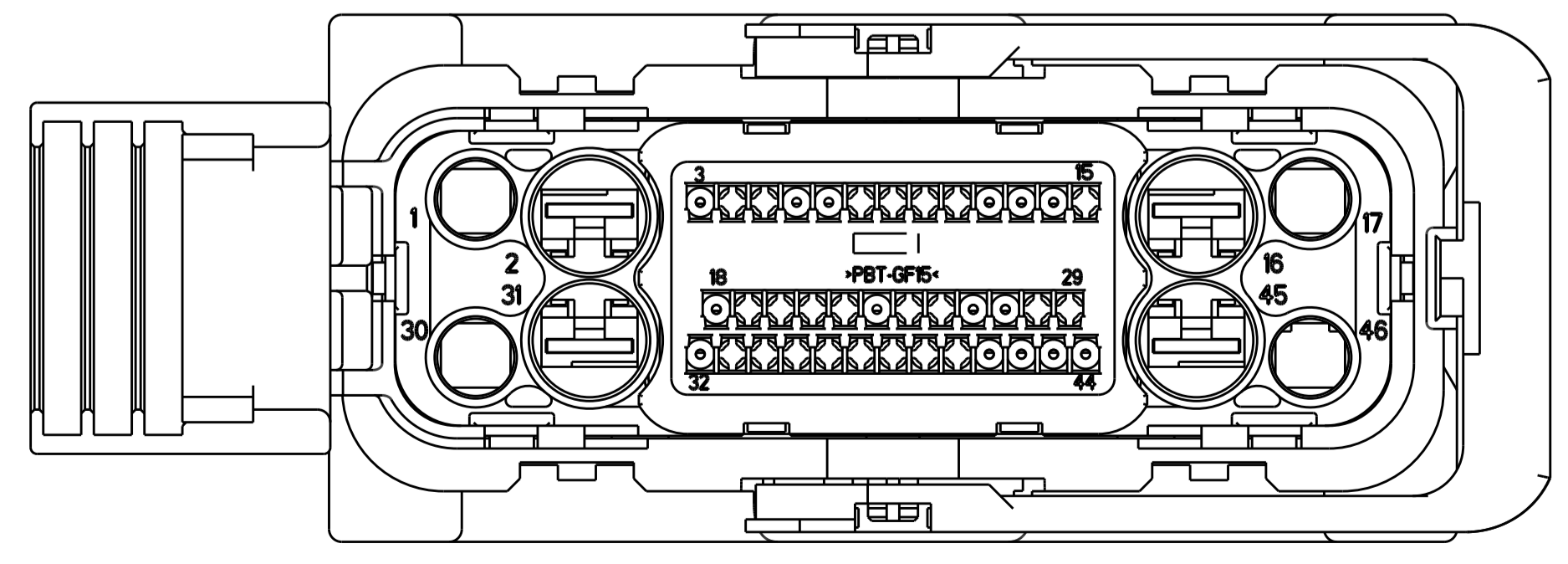

5-1326339-0
SCALE 2:1

THIS DRAWING IS A CONTROLLED DOCUMENT.		OWN: A. HOLT 01APR2003	TE Connectivity DRAWING MATRIX 46 POSITION EBC-440 PLUG ASSEMBLY
DIMENSIONS:		CHK: J. TONEY 01APR2003	
mm		APPV: J. TONEY 01APR2003	
0 PLC ± 1 PLC ± 2 PLC ± 3 PLC ± 4 PLC ± ANGLES ±		NAME: PRODUCT SPEC	
MATERIAL:		FINISH:	APPLICATION SPEC
		WEIGHT:	SIZE: CAGE CODE: DRAWING NO: RESTRICTED TO
		Customer Drawing	A1 00779 ©=1326534
		SCALE: NONE	SHEET 11 OF 12 REV AF7

PINOUT CONFIGURATION GEOMETRY

LOC	DIST	REVISIONS					
GP	00	P	LYR	DESCRIPTION	DATE	DWN	APVD
		-		SEE SHEET 1		-	-

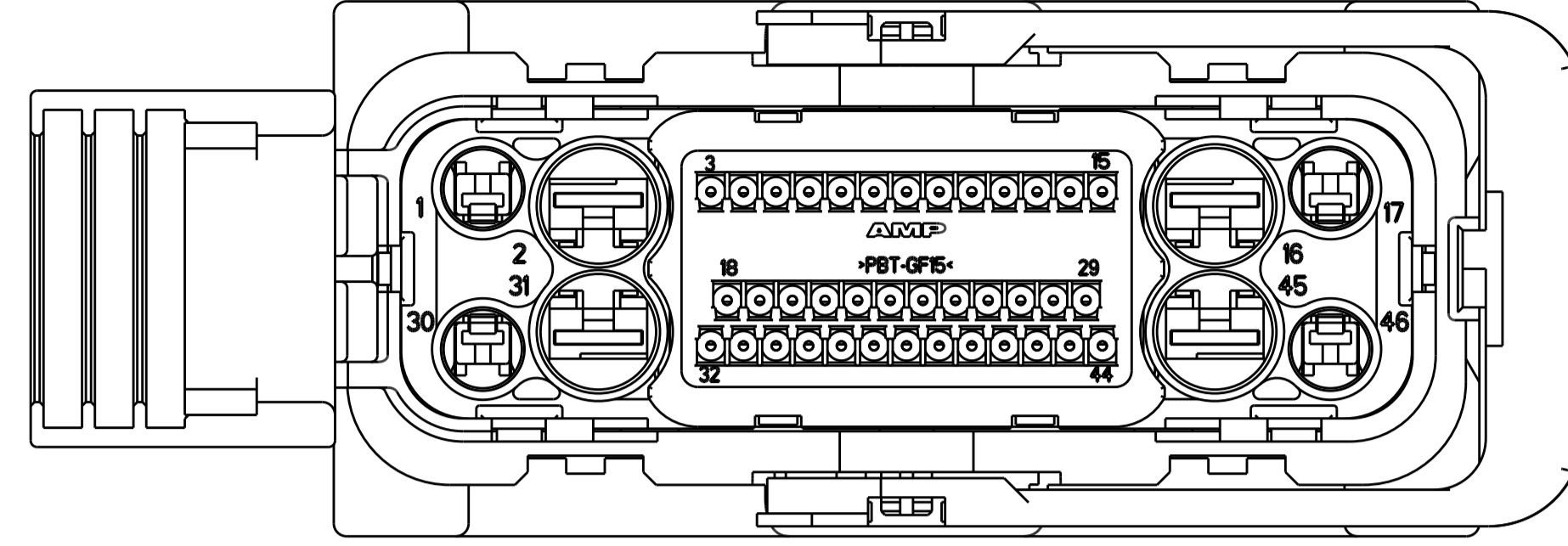

1326341-1
SCALE 2:1

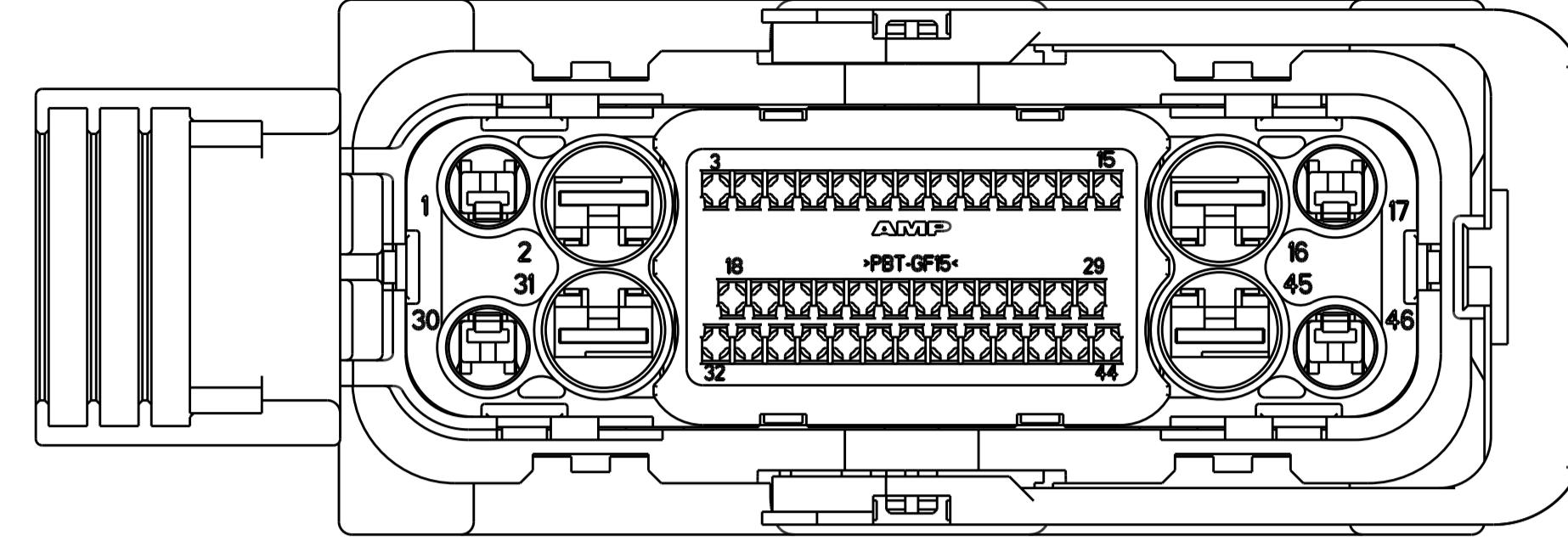

1326341-2
SCALE 2:1

THIS DRAWING IS A CONTROLLED DOCUMENT.		DWN A. HOLT 01APR2003	
DIMENSIONS:		CHK J. TONEY 01APR2003	
mm		APVD J. TONEY 01APR2003	
		TOLERANCES UNLESS OTHERWISE SPECIFIED: 0 PLC ± 1 PLC ± 2 PLC ± 3 PLC ± 4 PLC ± ANGLES ±	
MATERIAL	FINISH	WEIGHT	NAME DRAWING MATRIX 46 POSITION EBC-440 PLUG ASSEMBLY
-	-	-	SIZE CAGE CODE DRAWING NO RESTRICTED TO A1 00779 ©=1326534 -
Customer Drawing		SCALE NONE	SHEET 12 OF 12 REV AF7