

THIS DRAWING IS UNPUBLISHED. RELEASED FOR PUBLICATION
 © COPYRIGHT - BY TYCO ELECTRONICS CORPORATION. ALL RIGHTS RESERVED.

LOC	DIST	REVISIONS			
P	LTR	DESCRIPTION	DATE	DWN	APVD
H	-				
	A	EH01-0043-01	21-DEC-01	WJ	PJ
	AI	ECR-09-022508	23DEC09	AEG	JHA

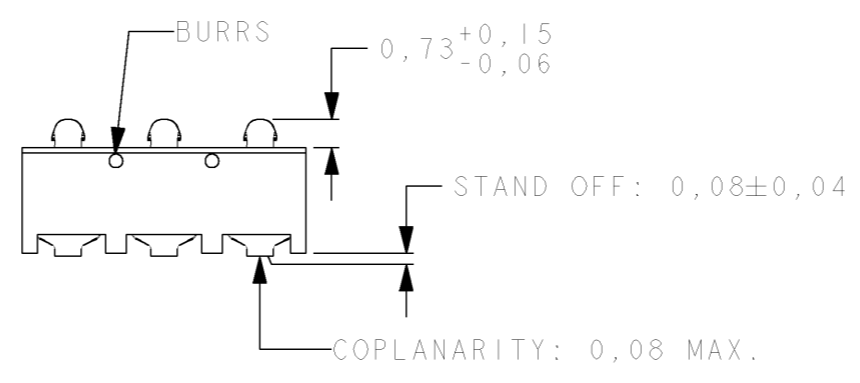
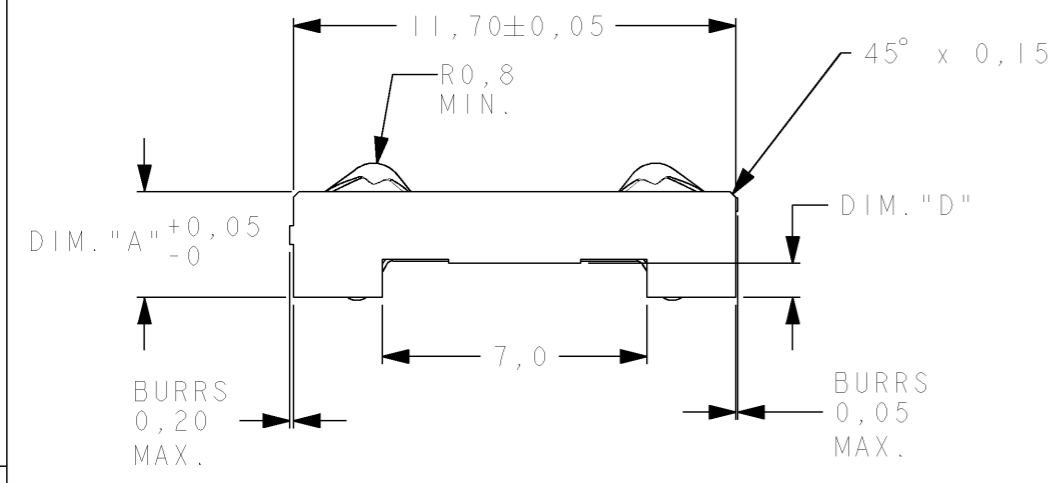
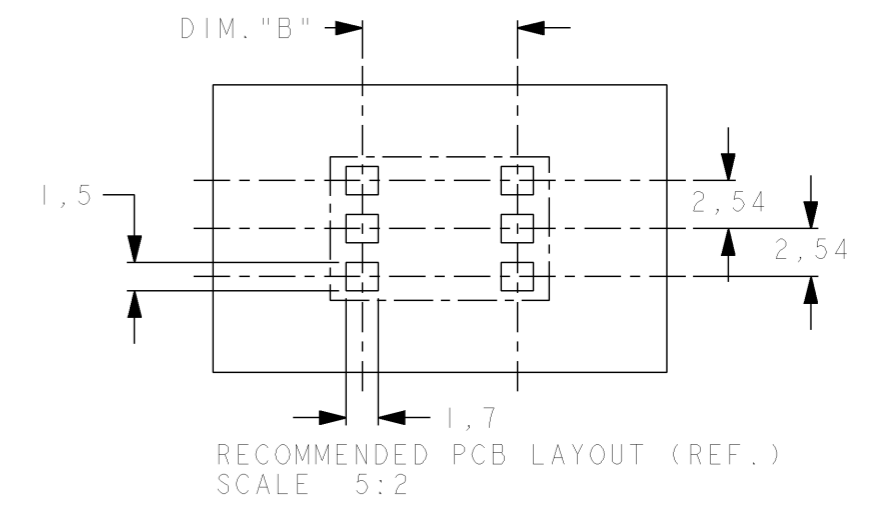
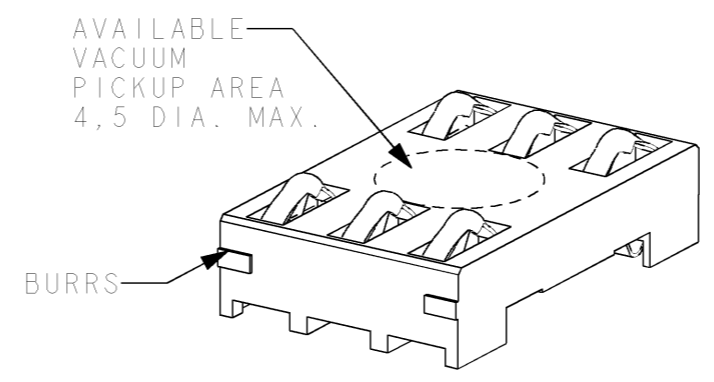
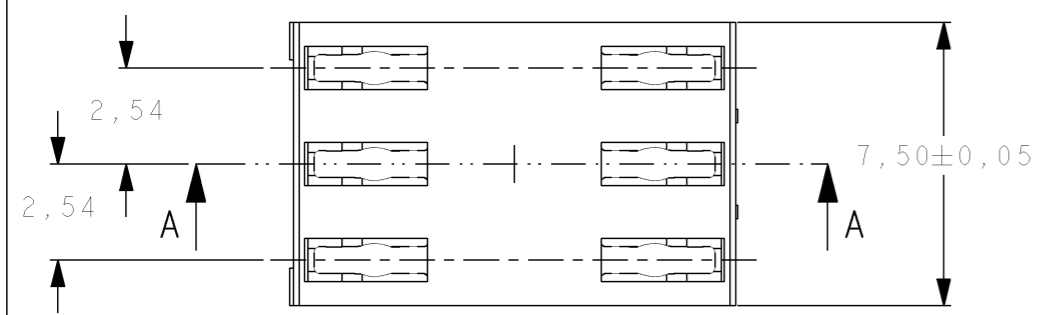

2-1377227-8 AS SHOWN

OBsolete

MATERIAL & FINISH:

HOUSING: GF LIQUID CRISTAL POLYMER UL 94V-0, COLOUR BLACK

CONTACT: PHOSPHOR BRONZE

- PLATING: - CARD SIDE 1,25 µm Au SELECTIVE
- SOLDER SIDE 0,1-0,2 µm Au SELECTIVE
- UNDER LAYER 1,3 µm Ni

PACKAGING: POCKET TAPE ACCORDING EIA 481-2

part number	DIM. "A"	DIM. "B"	DIM. "C"	DIM. "D"	TOOLED
1-1377227-9	1,9	8,3	0,0	0,0	YES
2-1377227-0	2,0	8,3	0,1	0,0	YES
2-1377227-1	2,1	8,3	0,2	0,1	NOT YET
2-1377227-2	2,2	8,3	0,3	0,2	YES
2-1377227-3	2,3	8,3	0,4	0,3	NOT YET
2-1377227-4	2,4	8,2	0,5	0,4	YES
2-1377227-5	2,5	8,2	0,5	0,5	YES
2-1377227-6	2,6	8,2	0,5	0,6	YES
2-1377227-7	2,7	8,1	0,5	0,7	NOT YET
2-1377227-8	2,8	8,1	0,5	0,8	YES
2-1377227-9	2,9	9,3	0,5	0,9	NOT YET
3-1377227-0	3,0	9,3	0,5	1,0	NOT YET
3-1377227-1	3,1	9,2	0,5	1,1	NOT YET
3-1377227-2	3,2	9,2	0,5	1,2	NOT YET
3-1377227-3	3,3	9,1	0,5	1,3	NOT YET
3-1377227-4	3,4	9,1	0,5	1,4	NOT YET
3-1377227-5	3,5	9,0	0,5	1,5	NOT YET
3-1377227-6	3,6	8,9	0,5	1,6	NOT YET
3-1377227-7	3,7	8,9	0,5	1,7	YES
3-1377227-8	3,8	8,8	0,5	1,8	NOT YET
3-1377227-9	3,9	8,7	0,5	1,9	NOT YET
4-1377227-0	4,0	8,6	0,5	2,0	YES

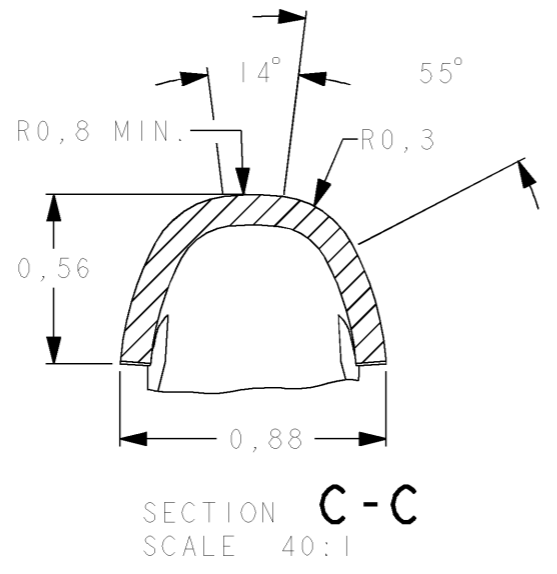
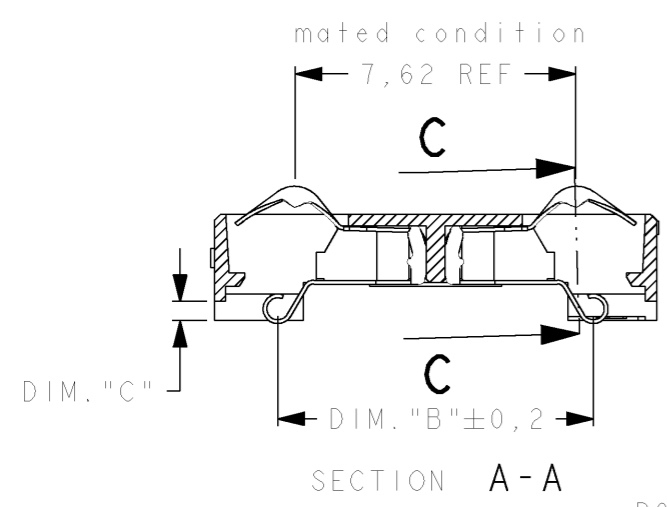

THIS DRAWING IS A CONTROLLED DOCUMENT FOR TYCO ELECTRONICS CORPORATION IT IS SUBJECT TO CHANGE AND THE CONTROLLING ENGINEERING ORGANIZATION SHOULD BE CONTACTED FOR THE LATEST REVISION.		DWN	W. Jansen	21Dec01
DIMENSIONS: mm		CHK	W. Jansen	21Dec01
TOLERANCES UNLESS OTHERWISE SPECIFIED:		APVD	P. Jaeger	21Dec01
0 PLC	±	PRODUCT SPEC	108-19122	
1 PLC	±	APPLICATION SPEC	114-19054	
2 PLC	±	WEIGHT	-	
3 PLC	±	CUSTOMER DRAWING		
4 PLC	±	SCALE	5:1	
ANGLES	±	SHEET	1 OF 1	
FINISH	see notes	REV	AI	

Tyco Electronics Tyco Electronics Corporation 's-Hertogenbosch, Nederland

NAME: **GENERIC SIM CONTACT MODULE WITH CONTACT STOP NO RIBS**

SIZE: **A3** CAGE CODE: **00779** DRAWING NO: **1377227** RESTRICTED TO: **-**