

THIS DRAWING IS UNPUBLISHED. RELEASED FOR PUBLICATION
 © COPYRIGHT copyright.dBTe- ALL RIGHTS RESERVED.

REVISIONS					
P	LTR	DESCRIPTION	DATE	DWN	APVD
A5		REVISED PER ECN-23-242776	15DEC2023	WLS	VS

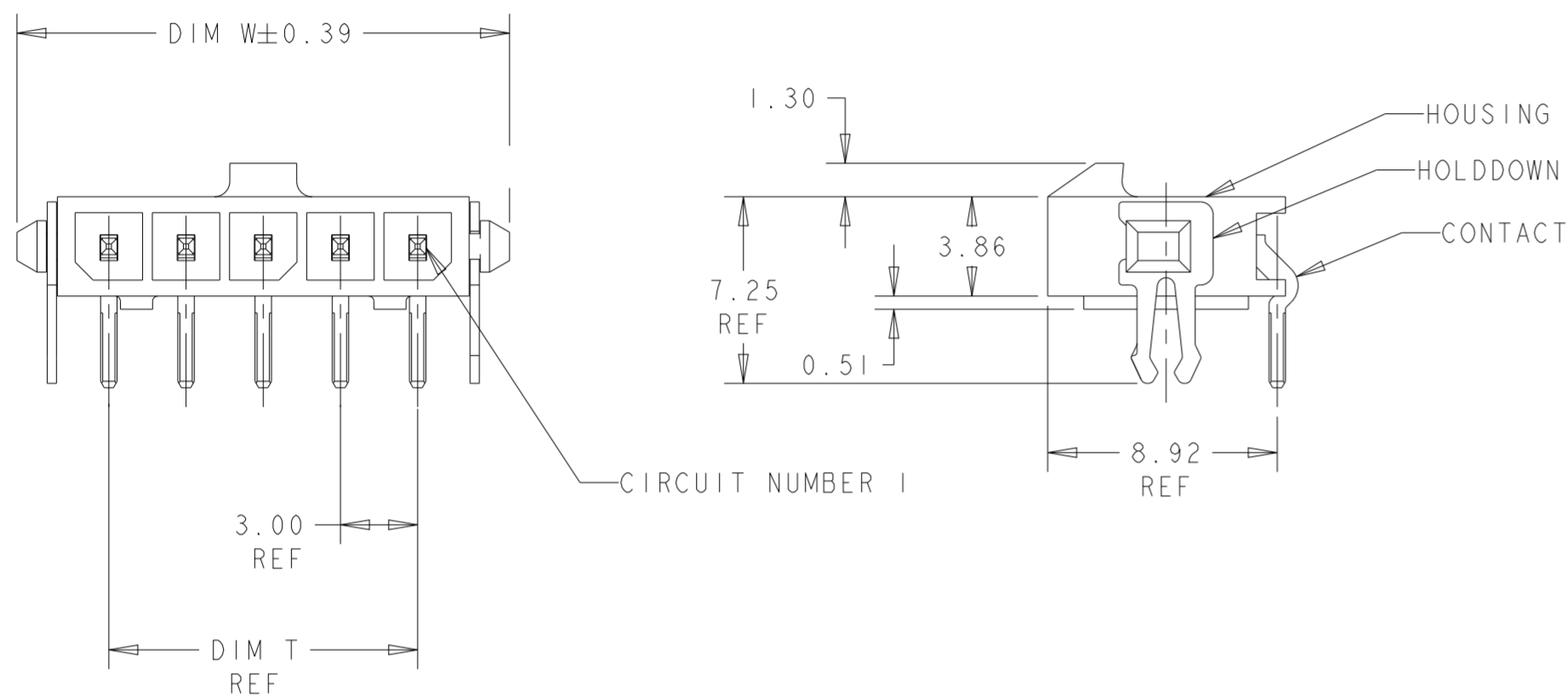

- 1 MATERIAL: HOUSING - UL 94V-0 RATED HIGH TEMP NYLON, COLOR BLACK.
CONTACTS - BRASS
HOLDDOWNS: - PHOSPHOR BRONZE.
- 2 RECOMMENDED PC BOARD THICKNESS OF 1.57.
- 3 PLATING: CONTACTS - 0.76µm MINIMUM GOLD ON MATING AREA,
2.54µm MINIMUM MATTE TIN ON SOLDER TAILS,
ALL OVER 1.27µm MINIMUM NICKEL.
HOLDDOWNS: 2.54µm MINIMUM MATTE TIN OVER 1.27µm MINIMUM NICKEL.
- 4 COUNTERPART RECOMMENDED IS PN 1445022 OR 2008571 (DASH ACC. TO NUMBER OF POSITION).
- 5 FOR REELING DIRECTION AND PACKAGING TYPE, SEE SPECIFICATION 114-13000.

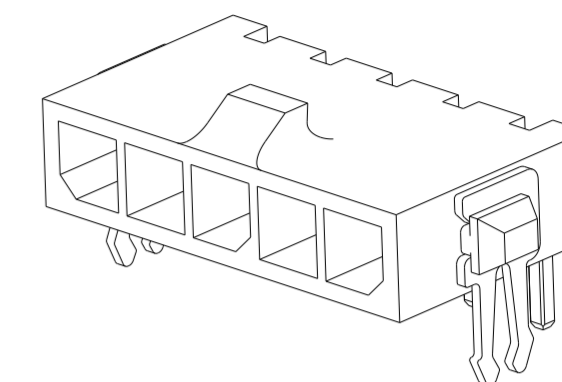
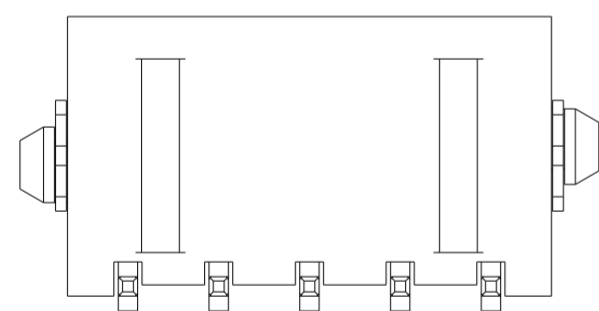

OBSOLETE	-33.00	37.43	33.00	40.14	12	3-1445097-2
OBSOLETE	-30.00	34.43	30.00	37.14	11	3-1445097-1
OBSOLETE	-27.00	31.43	27.00	34.14	10	3-1445097-0
OBSOLETE	-24.00	28.43	24.00	31.14	9	2-1445097-9
	21.00	25.43	21.00	28.14	8	2-1445097-8
OBSOLETE	-18.00	22.43	18.00	25.14	7	2-1445097-7
	15.00	19.43	15.00	22.14	6	2-1445097-6
	12.00	16.43	12.00	19.14	5	2-1445097-5
	9.00	13.43	9.00	16.14	4	2-1445097-4
	6.00	10.43	6.00	13.14	3	2-1445097-3
	3.00	7.43	3.00	10.14	2	2-1445097-2
	DIM Z	DIM V	DIM T	DIM W	NO. OF POSN	PART NUMBER

THIS DRAWING IS A CONTROLLED DOCUMENT.		DWN J. ROOT 09OCT2000	TE Connectivity		
DIMENSIONS: mm		CHK K. WHITAKER 17-APR-2001			
TOLERANCES UNLESS OTHERWISE SPECIFIED:		APVD C. JONES 17-APR-2001	NAME RIGHT ANGLE THRU HOLE HDR ASSY, 0.76 MIC GOLD CONTACTS, W/THRU HOLE HOLDDOWNS, SGL ROW, MICRO MATE-N-LOK™		
0 PLC ± 1 PLC ± 2 PLC ±0.20 3 PLC ± 4 PLC ± ANGLES ±1° FINISH		PRODUCT SPEC 108-1836	SIZE A2	CAGE CODE 00779	DRAWING NO C-1445097
MATERIAL 1		WEIGHT -	RESTRICTED TO -		
		CUSTOMER DRAWING	SCALE 4:1	SHEET 1 OF 2	REV A5

THIS DRAWING IS UNPUBLISHED. RELEASED FOR PUBLICATION
 © COPYRIGHT copyright.dBTe- ALL RIGHTS RESERVED.

REVISIONS					
P	LTR	DESCRIPTION	DATE	DWN	APVD
-	-	SEE SHEET 1	-	-	-

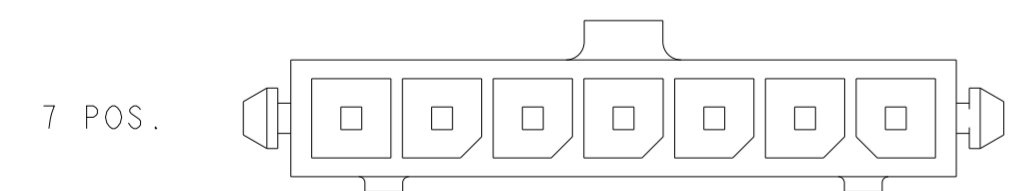
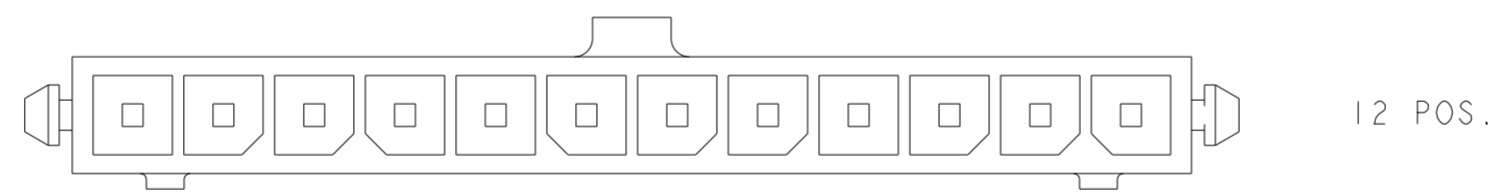
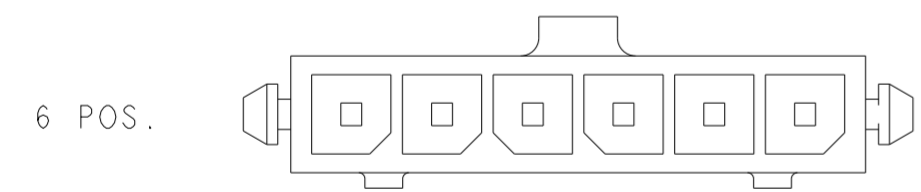
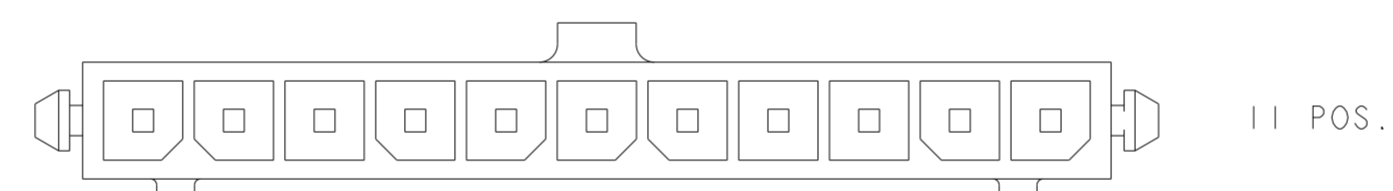
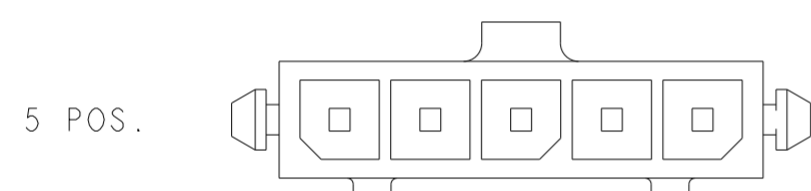
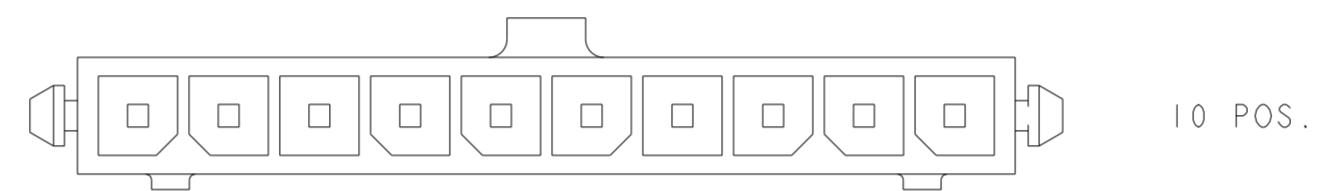
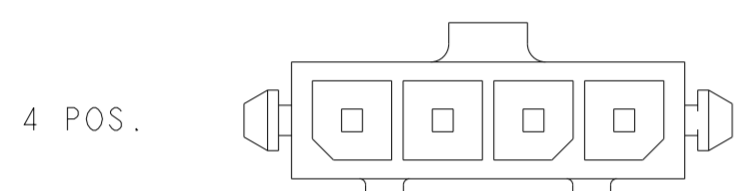
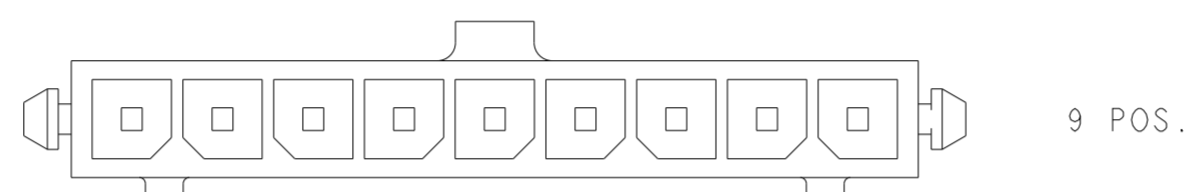
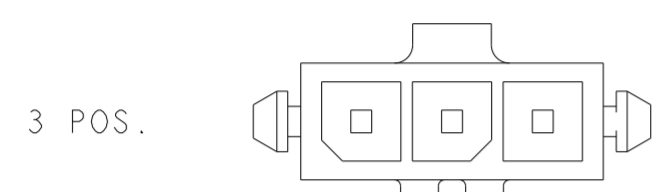
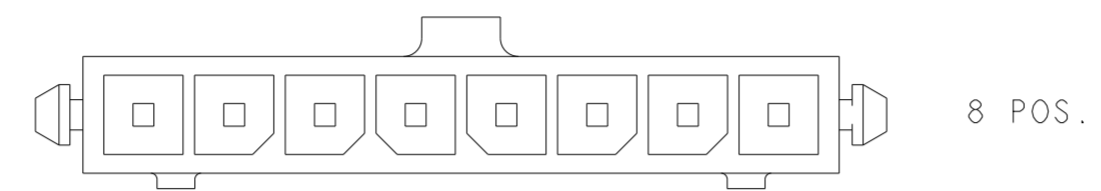
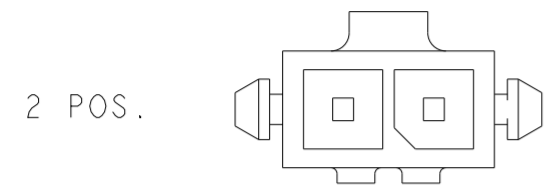

KEYING BY POSITION SIZE

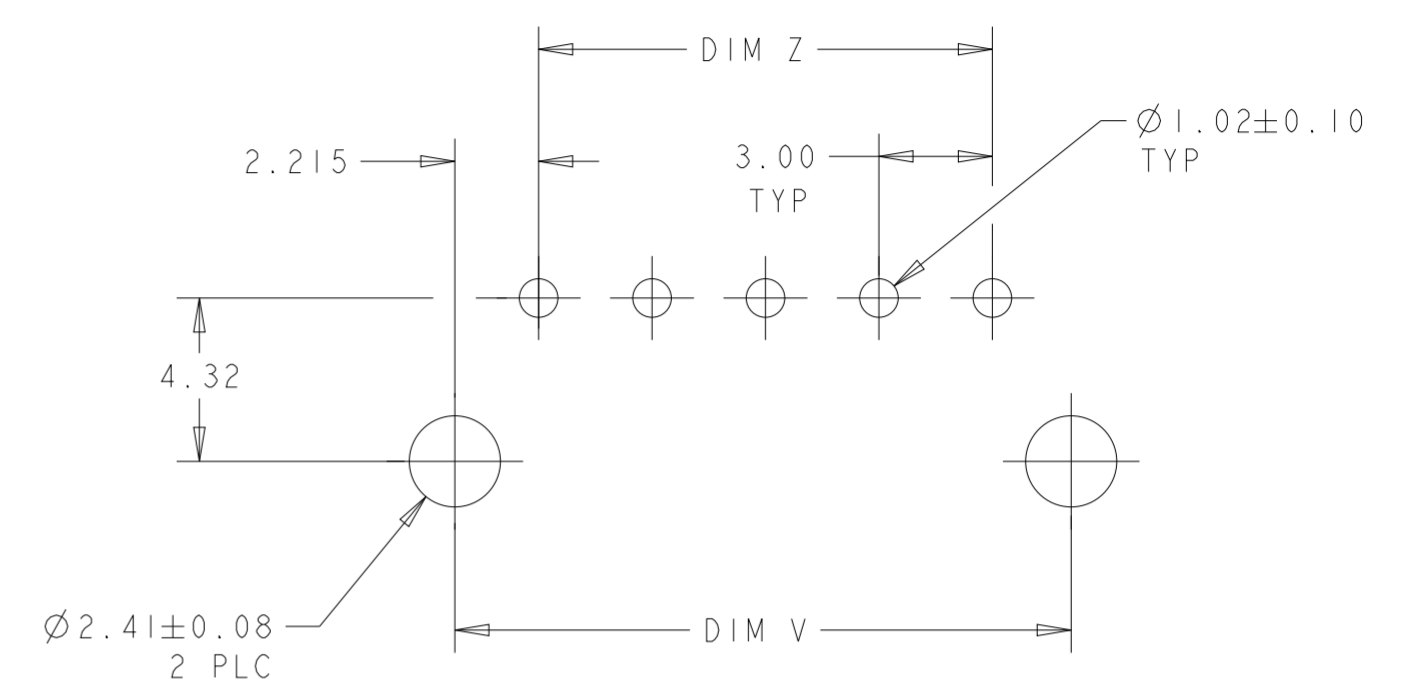

THIS DRAWING IS A CONTROLLED DOCUMENT.		DWN J. ROOT 09OCT2000	TE Connectivity	
DIMENSIONS: mm		CHK K. WHITAKER 17-APR-2001		
TOLERANCES UNLESS OTHERWISE SPECIFIED:		APVD C. JONES 17-APR-2001	NAME RIGHT ANGLE THRU HOLE HDR ASSY, 0.76 MIC GOLD CONTACTS, W/THRU HOLE HOLDDOWNS, SGL ROW, MICRO MATE-N-LOK	
		PRODUCT SPEC 108-1836	SIZE A2	CAGE CODE 00779
MATERIAL -		APPLICATION SPEC 114-13000	DRAWING NO C-1445097	RESTRICTED TO -
FINISH -		WEIGHT -	SCALE 4:1	SHEET 2 OF 2
		CUSTOMER DRAWING	REV A5	