

THIS DRAWING IS UNPUBLISHED. RELEASED FOR PUBLICATION  
 © COPYRIGHT - By - ALL RIGHTS RESERVED.

LOC		DIST		REVISIONS			
P	LTR	DESCRIPTION		DATE	DWN	APVD	
	A	INITIAL RELEASE		2 JUL 12	CAS	MKS	

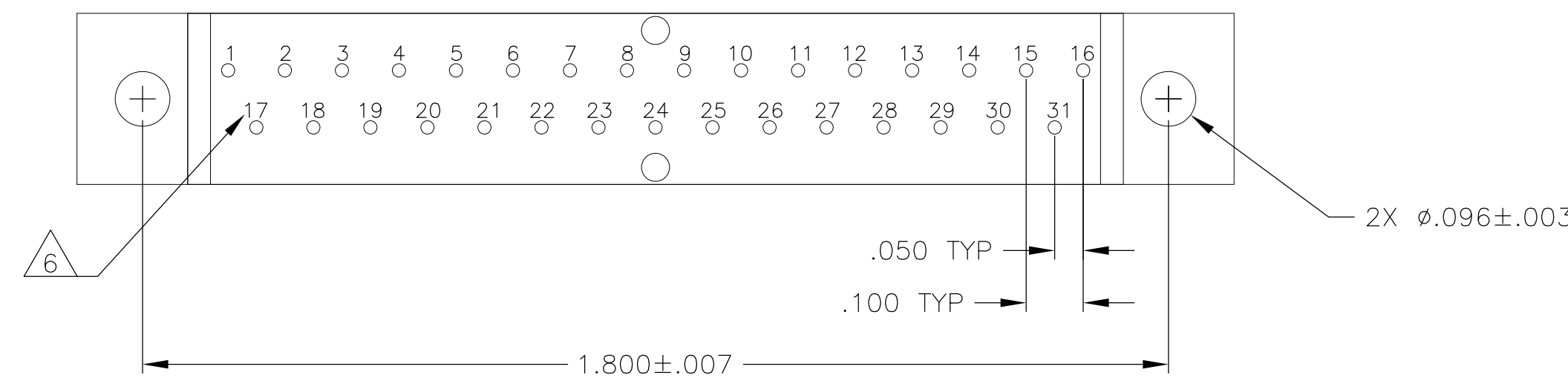
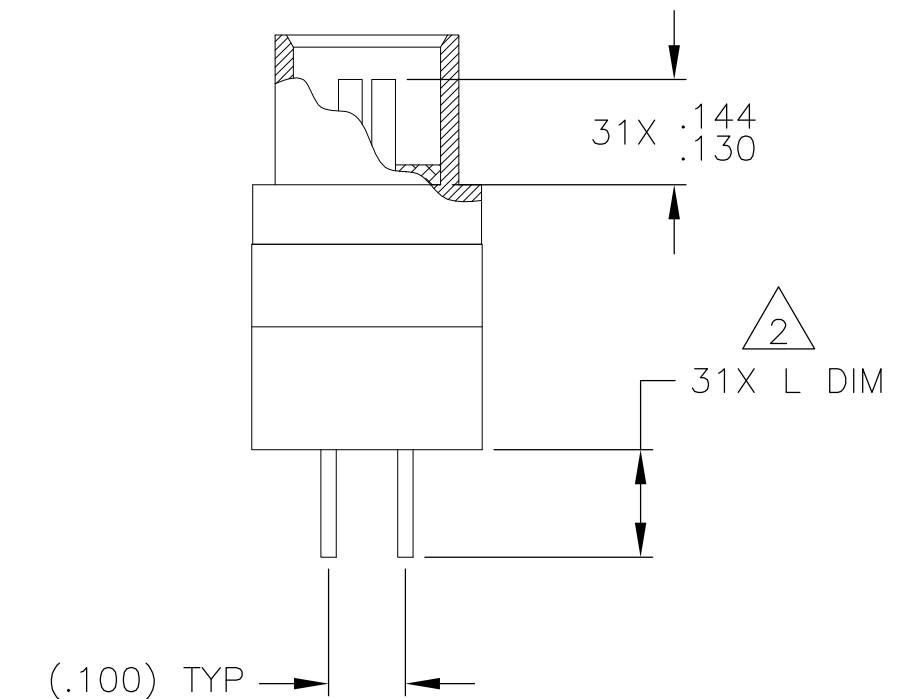
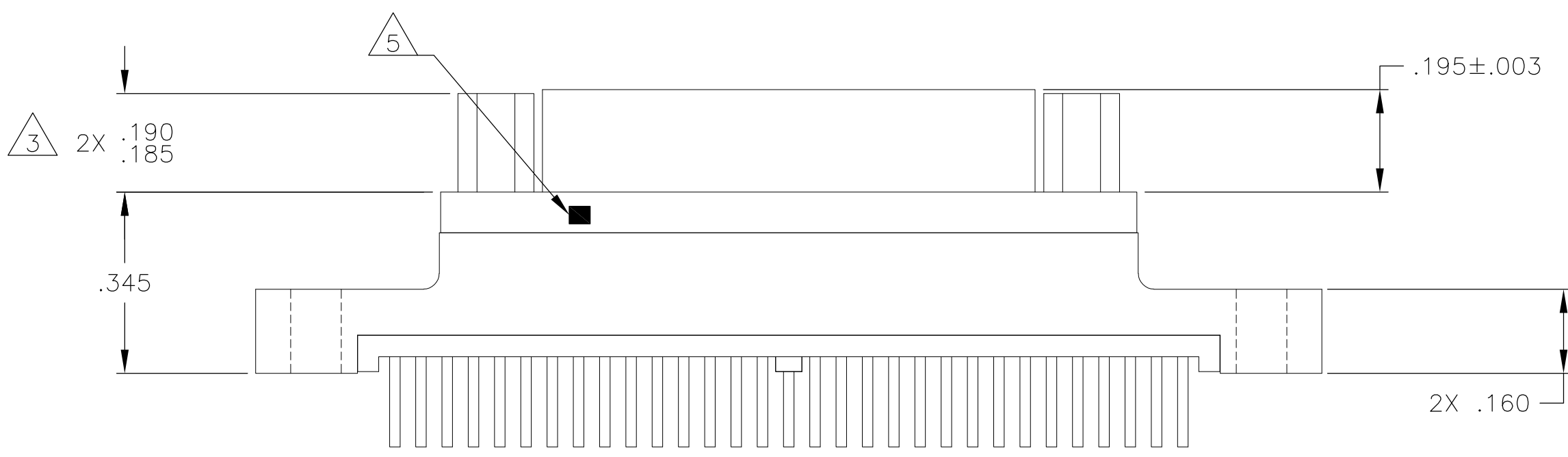
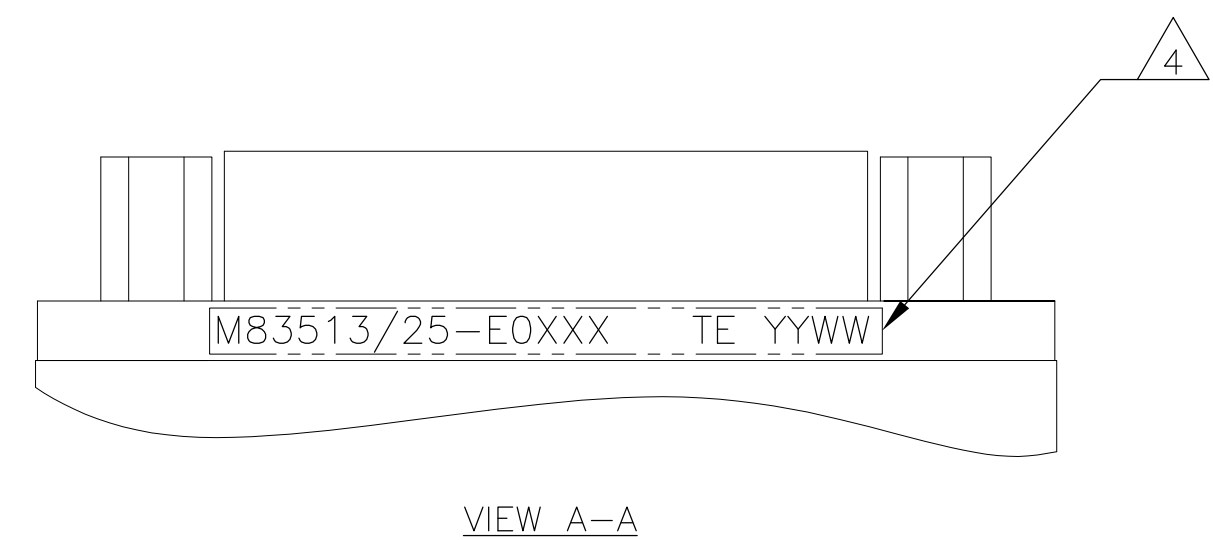
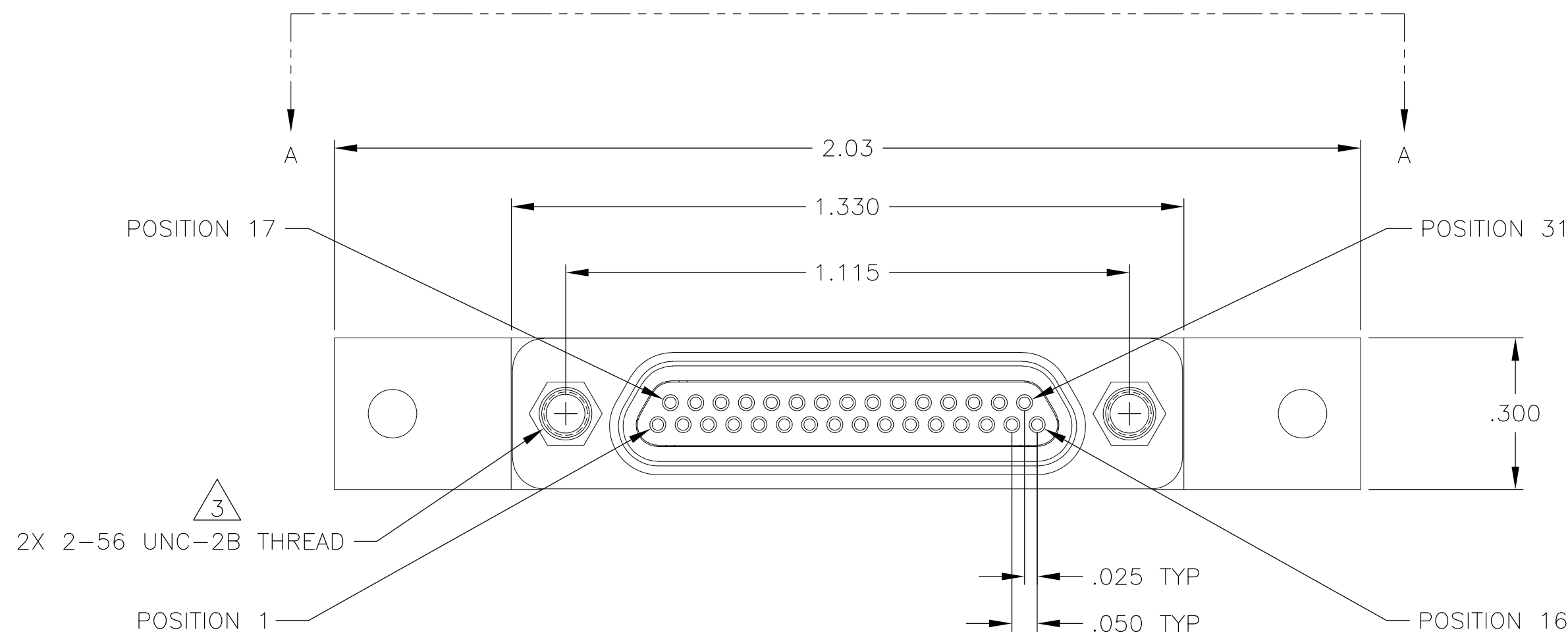

SEE SHEET 2 FOR NOTES

THIS DRAWING IS A CONTROLLED DOCUMENT.		DWN C SCHOLL	2 JUL 12	TE Connectivity	
DIMENSIONS: INCHES		CHK -	-		
TOLERANCES UNLESS OTHERWISE SPECIFIED:		APVD M STORRY	2 JUL 12	NAME RECEPTACLE ASSEMBLY, MCKS, ST1 STRAIGHT TERMINATION, PCB MOUNT, 2 ROW, SIZE 31, PER MIL-DTL-83513/25	
0 PLC ± -		PRODUCT SPEC	-	SIZE A2	CAGE CODE 98278
1 PLC ± -		APPLICATION SPEC	-	DRAWING NO C=1532278	RESTRICTED TO -
2 PLC ± .010		WEIGHT	-	SCALE 4:1	SHEET 1 of 2
3 PLC ± .005		CUSTOMER DRAWING	-	REV A	
4 PLC ± -					
ANGLES ± 1°					
FINISH SEE NOTES					
MATERIAL SEE NOTES					

THIS DRAWING IS UNPUBLISHED. RELEASED FOR PUBLICATION  
 © COPYRIGHT - By - ALL RIGHTS RESERVED.

LOC		DIST		REVISIONS			
P	LTR	DESCRIPTION	DATE	DWN	APVD		
-	-	SEE SHEET 1	-	-	-		

TE PART NUMBER	MIL-DTL-83513 PIN	MCKS DESCRIPTION	SHELL FINISH $\triangle 1$	HARDWARE $\triangle 3$	L DIM $\pm .015$
1532278-1	M83513/25-E01CN	MCKS-C2-B-31SST1	CADMIUM	NONE	.109
1532278-2	M83513/25-E01CP	MCKS-C2-P-31SST1	CADMIUM	JACKPOSTS	.109
1532278-3	M83513/25-E01NN	MCKS-N1-B-31SST1	NICKEL	NONE	.109
1532278-4	M83513/25-E01NP	MCKS-N1-P-31SST1	NICKEL	JACKPOSTS	.109
1532278-5	M83513/25-E02CN	MCKS-C2-B-31SST1A	CADMIUM	NONE	.140
1532278-6	M83513/25-E02CP	MCKS-C2-P-31SST1A	CADMIUM	JACKPOSTS	.140
1532278-7	M83513/25-E02NN	MCKS-N1-B-31SST1A	NICKEL	NONE	.140
1532278-8	M83513/25-E02NP	MCKS-N1-P-31SST1A	NICKEL	JACKPOSTS	.140
1532278-9	M83513/25-E03CN	MCKS-C2-B-31SST1B	CADMIUM	NONE	.172
1-1532278-0	M83513/25-E03CP	MCKS-C2-P-31SST1B	CADMIUM	JACKPOSTS	.172
1-1532278-1	M83513/25-E03NN	MCKS-N1-B-31SST1B	NICKEL	NONE	.172
1-1532278-2	M83513/25-E03NP	MCKS-N1-P-31SST1B	NICKEL	JACKPOSTS	.172

- $\triangle 1$  SHELL MATERIAL: 6061-T6 ALUMINUM  
 FINISH OPTIONS:  
 ELECTROLESS NICKEL PLATED PER SAE-AMS-C-26074 OR SAE AMS 2404 OR CADMIUM PLATED PER SAE-AMS-QQ-P-416 WITH YELLOW CHROMATE  
 INSULATOR: LIQUID CRYSTAL POLYMER (LCP)  
 HARDWARE: 300 SERIES STAINLESS STEEL  
 TB BOX: POLYPHENYLENE SULFIDE (PPS) AND EPOXY POTTING
- $\triangle 2$  TERMINATION: 24AWG GOLD PLATED COPPER WIRE, Sn63Pb37 SOLDER DIPPED UP TO MOUNTING SURFACE AT A MINIMUM
- $\triangle 3$  JACKPOST HARDWARE SHALL BE PERMANENTLY INSTALLED AS SHOWN WHEN REQUIRED BY THE MIL PIN. JACKPOST DIMENSIONS AND REQUIREMENTS ARE DEFINED IN MIL-DTL-83513/5.
- $\triangle 4$  CONNECTOR SHALL BE MARKED IN ACCORDANCE WITH METHOD I OF MIL-STD-1285. MARKING SHALL CONTAIN THE MILITARY PIN, CAGE CODE (OR TE), AND DATE CODE. EXAMPLE: M83513/25-E0XXX TE YYWW (WHERE XXX IS PART OF THE PIN SHOWN IN THE "MIL-DTL-83513 PIN" COLUMN OF THE PART NUMBER TABLE, AND YYWW IS THE DATE CODE). THE MARKING MUST BE PRINTED ON THE FLANGE. TEXT HEIGHT SHALL BE .035 INCH MINIMUM.
- $\triangle 5$  POSITION 1 SHALL BE INDICATED BY AN IDENTIFIABLE MARK, LOCATED APPROXIMATELY AS SHOWN ON THE POSITION 1 SIDE OF THE CONNECTOR FLANGE. THIS MARK SHALL BE INCLUDED AS PART OF THE PART MARKING INFORMATION.
- $\triangle 6$  TERMINAL IDENTIFICATION NUMBERS AS SHOWN DO NOT ACTUALLY APPEAR ON THE PART (FOR IDENTIFICATION ONLY)
- 7 ALL REQUIREMENTS CONFORM TO MIL-DTL-83513/25. SEE MIL-SPEC FOR DETAILED INTERFACE DIMENSIONS AND SUGGESTED PCB LAYOUTS

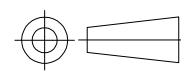
THIS DRAWING IS A CONTROLLED DOCUMENT.		DWN C SCHOLL	2 JUL 12	 TE Connectivity	
DIMENSIONS: INCHES		CHK -	-		
TOLERANCES UNLESS OTHERWISE SPECIFIED:		APVD M STORRY	2 JUL 12	NAME RECEPTACLE ASSEMBLY, MCKS, ST1 STRAIGHT TERMINATION, PCB MOUNT, 2 ROW, SIZE 31, PER MIL-DTL-83513/25	
		PRODUCT SPEC -	APPLICATION SPEC -	SIZE A2	CAGE CODE 98278
MATERIAL SEE NOTES		FINISH SEE NOTES	WEIGHT -	DRAWING NO C=1532278	RESTRICTED TO -
CUSTOMER DRAWING			SCALE 4:1	SHEET 2 of 2	REV A