

LOC	DIST	REVISIONS					
E	B	P	LTR	DESCRIPTION	DATE	DWN	APVD
			BA	NEW RELEASE	28FEB2013	KR	TN

FOR FURTHER INFORMATION SEE DATA SHEET FOR RN73 SERIES-HIGH PRECISION RESISTORS (SMD)

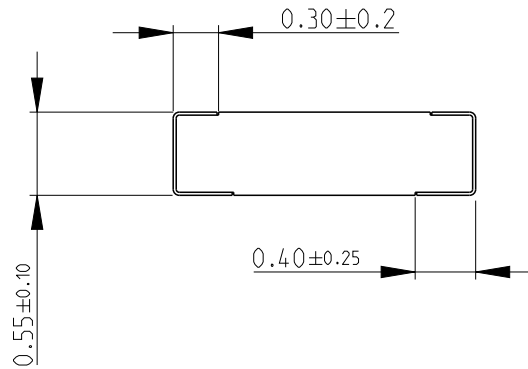

RECOMMENDED LAND PATTERN

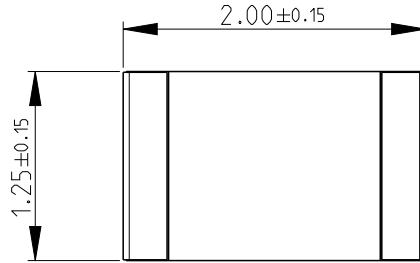
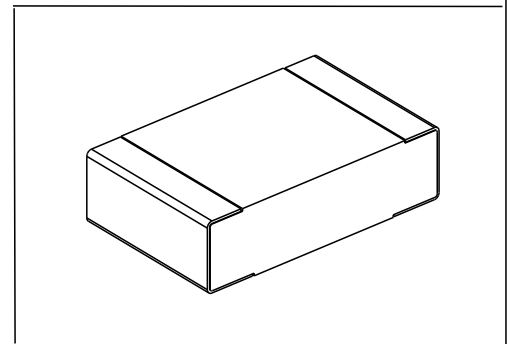
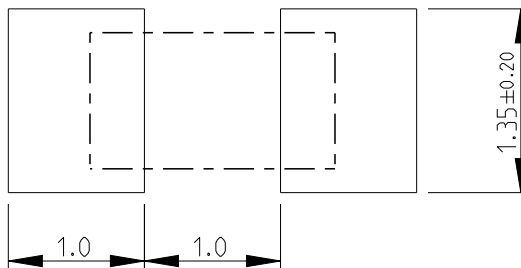

2010

RELEASED FOR PUBLICATION

ALL RIGHTS RESERVED.

THIS DRAWING IS UNPUBLISHED.

BY -

© COPYRIGHT 2010

DIMENSIONS:		DWN	28FEB2013	MATERIAL	-	FINISH	-
mm		RAGHAVENDRA.K		TE Connectivity			
TOLERANCES UNLESS OTHERWISE SPECIFIED:		CHK	28FEB2013				
0 PLC	±0.2	ALLAN.P		NAME HIGH PRECISION RESISTORS - SMD SERIES RN73 2A			
1 PLC	±0.1	APVD	28FEB2013				
2 PLC	±	TONY.N		SIZE	CAGE CODE	DRAWING NO	RESTRICTED TO
3 PLC	±	PRODUCT SPEC	-	A 4	00779	©=161426	-
4 PLC	±	APPLICATION SPEC	-	Customer Drawing			
ANGLES	±5°	WEIGHT	0.005 GR	SCALE	20:1	SHEET	1 OF 1
						REV	BA