

REVISIONS

P	LTR	DESCRIPTION	DATE	DWN	APVD
	BA1	REVISED PER ECO-11-005150	29MAR2011	RK	HMR
	BA2	NEW PRODUCT INTRODUCTION	23JUN2022	DM	AP
	BA3	NEW PRODUCT INTRODUCTION	03NOV2023	DM	AP

FOR FURTHER INFORMATION SEE DATA SHEET FOR SERIES ER/ERV- HIGH POWER RESISTORS

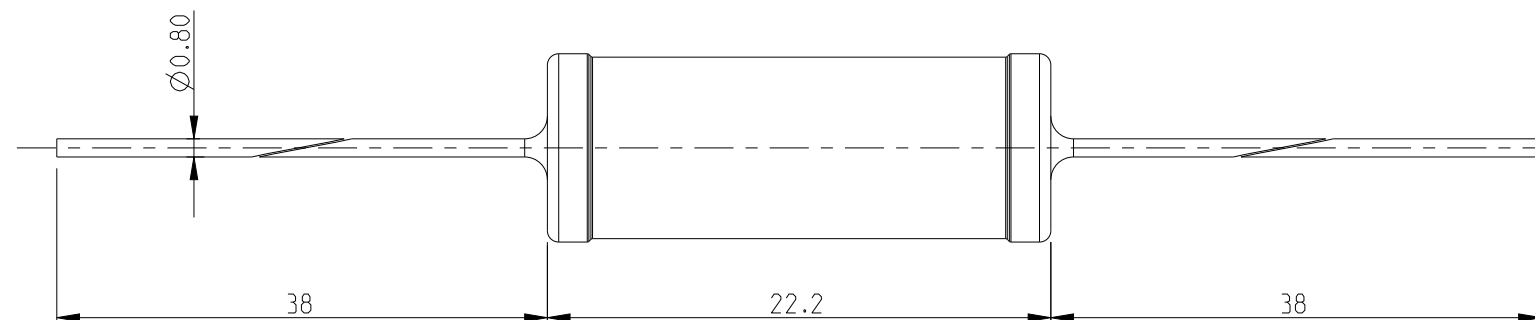
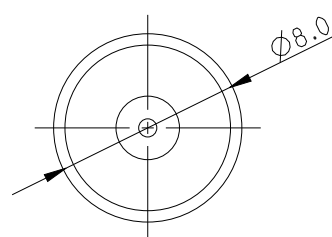

RoHS Compliant

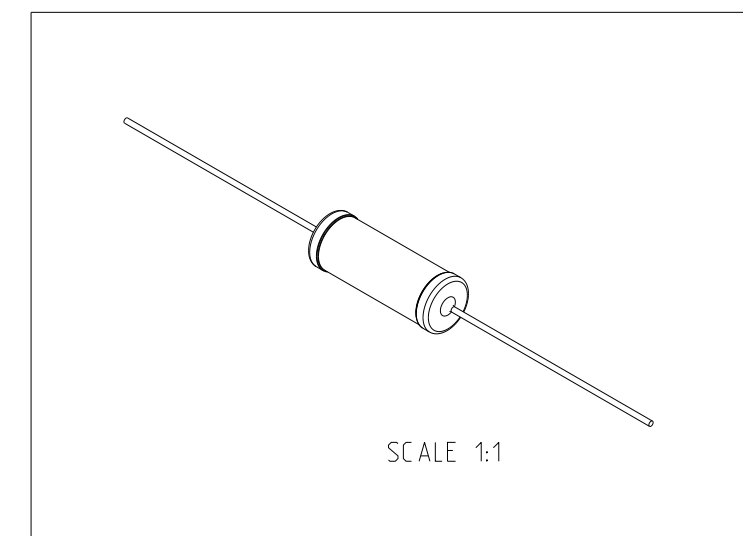

THIS DRAWING IS A CONTROLLED DOCUMENT.		DWN MAHARUDRA 11FEB2010		
DIMENSIONS: mm		CHK ALLAN.P 11FEB2010		
TOLERANCES UNLESS OTHERWISE SPECIFIED:		APVD STEPHEN.P 11FEB2010	NAME HIGH POWER RESISTORS TYPE ER58 SERIES	
0 PLC ± 0.2		PRODUCT SPEC	SIZE A3	
1 PLC ± 0.1		APPLICATION SPEC	CAGE CODE 00779	DRAWING NO C-1623750
2 PLC \pm		WEIGHT	RESTRICTED TO	
3 PLC \pm			SCALE 3:1	
4 PLC \pm			SHEET 1 OF 3	
ANGLES $\pm 5^\circ$			REV BA3	
FINISH				
MATERIAL				

REVISIONS

P	LTR	DESCRIPTION	DATE	DWN	APVD
-		SEE SHEET 1	-	-	-

SCHEDULE

TCPN	CATALOGUE NUMBER	PART DESCRIPTION	PART STATUS
1623750-1	ER58100RJT	ER58 100R 5% AMMO	PRODUCTION
1623750-2	ER5810KJT	ER58 10K 5% AMMO	PRODUCTION
1623750-3	ER5810RJT	ER58 10R 5% AMMO	PRODUCTION
1623750-4	ER58120RJT	ER58 120R 5% AMMO	PRODUCTION
1623750-5	ER58150RJT	ER58 150R 5% AMMO	PRODUCTION
1623750-6	ER5815KJT	ER58 15K 5% AMMO	PRODUCTION
1623750-7	ER5815RJT	ER58 15R 5% AMMO	PRODUCTION
1623750-8	ER58180RJT	ER58 180R 5% AMMO	PRODUCTION
1623750-9	ER581K0JT	ER58 1K0 5% AMMO	PRODUCTION
1-1623750-0	ER581K8JT	ER58 1K8 5% AMMO	PRODUCTION
1-1623750-1	ER581R0JT	ER58 1R0 5% AMMO	PRODUCTION
1-1623750-2	ER5820KDT	ER58 20K 0.5% AMMO	PRODUCTION
1-1623750-3	ER5820KJT	ER58 20K 5% AMMO	PRODUCTION
1-1623750-4	ER58220RJT	ER58 220R 5% AMMO	PRODUCTION
1-1623750-5	ER5822RJT	ER58 22R 5% AMMO	PRODUCTION
1-1623750-6	ER5824RJT	ER58 24R 5% AMMO	PRODUCTION
1-1623750-7	ER58270RJT	ER58 270R 5% AMMO	PRODUCTION
1-1623750-8	ER582K2JT	ER58 2K2 5% AMMO	PRODUCTION
1-1623750-9	ER582R2JT	ER58 2R2 5% AMMO	PRODUCTION
2-1623750-0	ER5833RJT	ER58 33R 5% AMMO	PRODUCTION
2-1623750-1	ER583K9JR	ER58 3K9 5% REELED	DISCONTINUED
2-1623750-2	ER583R3JT	ER58 3R3 5% AMMO	PRODUCTION
2-1623750-3	ER583R9JT	ER58 3R9 5% AMMO	PRODUCTION
2-1623750-4	ER58470RJT	ER58 470R 5% AMMO	PRODUCTION
2-1623750-5	ER5847RJT	ER58 47R 5% AMMO	PRODUCTION
2-1623750-6	ER584K7JT	ER58 4K7 5% AMMO	PRODUCTION
2-1623750-7	ER584R7JT	ER58 4R7 5% AMMO	PRODUCTION
2-1623750-8	ER58560RJT	ER58 560R 5% AMMO	PRODUCTION
2-1623750-9	ER5856RJT	ER58 56R 5% AMMO	PRODUCTION
3-1623750-0	ER585R6JT	ER58 5R6 5% AMMO	PRODUCTION
3-1623750-1	ER58680RJT	ER58 680R 5% AMMO	PRODUCTION
3-1623750-2	ER5868RJT	ER58 68R 5% AMMO	PRODUCTION

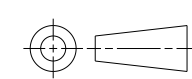
THIS DRAWING IS A CONTROLLED DOCUMENT.		DWN MAHARUDRA 11FEB2010	 TE Connectivity	
		CHK ALLAN.P 11FEB2010		
DIMENSIONS: mm		APVD STEPHEN.P 11FEB2010	NAME HIGH POWER RESISTORS TYPE ER58 SERIES	
		PRODUCT SPEC -	RESTRICTED TO -	
TOLERANCES UNLESS OTHERWISE SPECIFIED: 0 PLC ±0.2 1 PLC ±0.1 2 PLC ± 3 PLC ± 4 PLC ± ANGLES ±5°		APPLICATION SPEC -	SIZE A3	CAGE CODE 00779
MATERIAL -		WEIGHT -	DRAWING NO C-1623750	SCALE 3:1
		CUSTOMER DRAWING	SHEET 2 OF 3	REV BA3

REVISIONS

SCHEDULE			
TCPN	CATALOGUE NUMBER	PART DESCRIPTION	PART STATUS
3-1623750-3	ER586K8JT	ER58 6K8 5% AMMO	PRODUCTION
3-1623750-4	ER586R8JT	ER58 6R8 5% AMMO	PRODUCTION
3-1623750-5	ER587R5JT	ER58 7R5 5% AMMO	PRODUCTION
3-1623750-6	ER5882RJT	ER58 82R 5% AMMO	PRODUCTION
3-1623750-7	ER588R2DT	ER58 8R2 0.5% AMMO	PRODUCTION
3-1623750-8	ER588R2JT	ER58 8R2 5% AMMO	PRODUCTION
3-1623750-9	ER58R03KT	ER58 R03 10% AMMO	PRODUCTION
4-1623750-0	ER58R05JT	ER58 R05 5% AMMO	PRODUCTION
4-1623750-1	ER58R07KT	ER58 R07 10% AMMO	PRODUCTION
4-1623750-2	ER58R10FT	ER58 R10 1% AMMO	DISCONTINUED
4-1623750-3	ER58R10JT	ER58 R10 5% AMMO	PRODUCTION
4-1623750-4	ER58R11JT	ER58 R11 5% AMMO	PRODUCTION
4-1623750-5	ER58R15JT	ER58 R15 5% AMMO	PRODUCTION
4-1623750-6	ER58R18JT	ER58 R18 5% AMMO	PRODUCTION
4-1623750-7	ER58R22JT	ER58 R22 5% AMMO	PRODUCTION
4-1623750-8	ER58R33JT	ER58 R33 5% AMMO	PRODUCTION
4-1623750-9	ER58R47JT	ER58 R47 5% AMMO	PRODUCTION
5-1623750-0	ER58R50JT	ER58 R50 5% AMMO	PRODUCTION
5-1623750-1	ER58R68JT	ER58 R68 5% AMMO	PRODUCTION
5-1623750-2	ER58R47KT	ER58 R47 10% AMMO	DISCONTINUED
5-1623750-3	ER58R10KT	ER58 R10 10% AMMO	DISCONTINUED
5-1623750-4	ER58R22KT	ER58 R22 10% AMMO	DISCONTINUED
5-1623750-5	ER58R33KT	ER58 R33 10% AMMO	DISCONTINUED
5-1623750-6	ER58R68KT	ER58 R68 10% AMMO	DISCONTINUED
5-1623750-7	ER58300RJT	ER58 300R 5% AMMO	PRODUCTION
5-1623750-8	ER581R8JT	ER58 1R8 5% AMMO	PRODUCTION
5-1623750-9	ER5810KFT	ER58 10K 1% AMMO	PRODUCTION
6-1623750-0	ER5820KFT	ER58 20K 1% AMMO	PRODUCTION
6-1623750-1	ER582K4JT	ER58 2K4 5% AMMO	PRODUCTION
6-1623750-2	ER5840KJT	ER58 40K 5% AMMO	DISCONTINUED
6-1623750-3	ER5818RJT	ER58 18R 5% AMMO	PRODUCTION
6-1623750-4	ER587K5JT	ER58 7K5 5% AMMO	PRODUCTION
6-1623750-5	ER588K2JT	ER58 8K2 5% AMMO	PRODUCTION

P	LTR	DESCRIPTION	DATE	DWN	APVD
	-	SEE SHEET 1	-	-	-

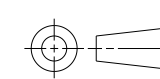
THIS DRAWING IS A CONTROLLED DOCUMENT.		DWN MAHARUDRA 11FEB2010	 TE Connectivity	
		CHK ALLAN.P 11FEB2010		
DIMENSIONS: mm		APVD STEPHEN.P 11FEB2010	NAME HIGH POWER RESISTORS TYPE ER58 SERIES	
		PRODUCT SPEC -		
TOLERANCES UNLESS OTHERWISE SPECIFIED: 0 PLC ±0.2 1 PLC ±0.1 2 PLC ± 3 PLC ± 4 PLC ± ANGLES ±5°		APPLICATION SPEC -	SIZE A3	CAGE CODE 00779
MATERIAL -		WEIGHT -	DRAWING NO C-1623750	RESTRICTED TO -
		CUSTOMER DRAWING	SCALE 3:1	SHEET 3 OF 3
				REV BA3