

REVISIONS

P	LTR	DESCRIPTION	DATE	DWN	APVD
	BA	NEW RELEASE	12OCT2010	PT	St.P
	BB	ECR-11-016776	12AUG2011	PSK	JC
	BB1	TUBE PACKAGING ADDED TO DRAWING	25MAR2022	AJ	AP

NOTES:

- 1. FOR FURTHER INFORMATION SEE DATA SHEET FOR SQ SERIES HIGH POWER RESISTOR

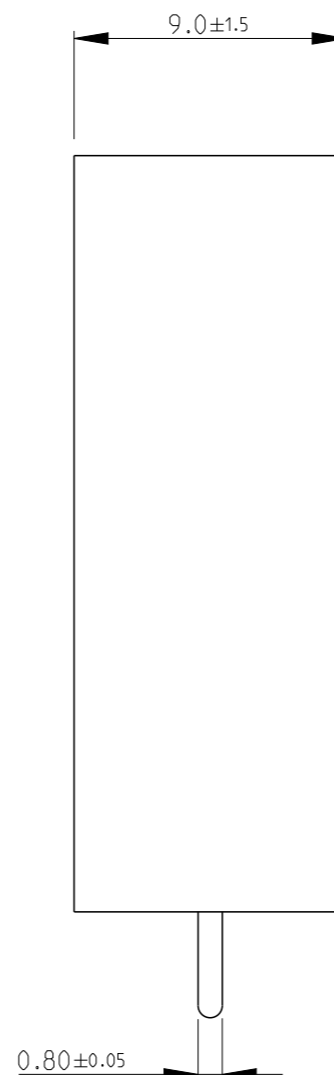
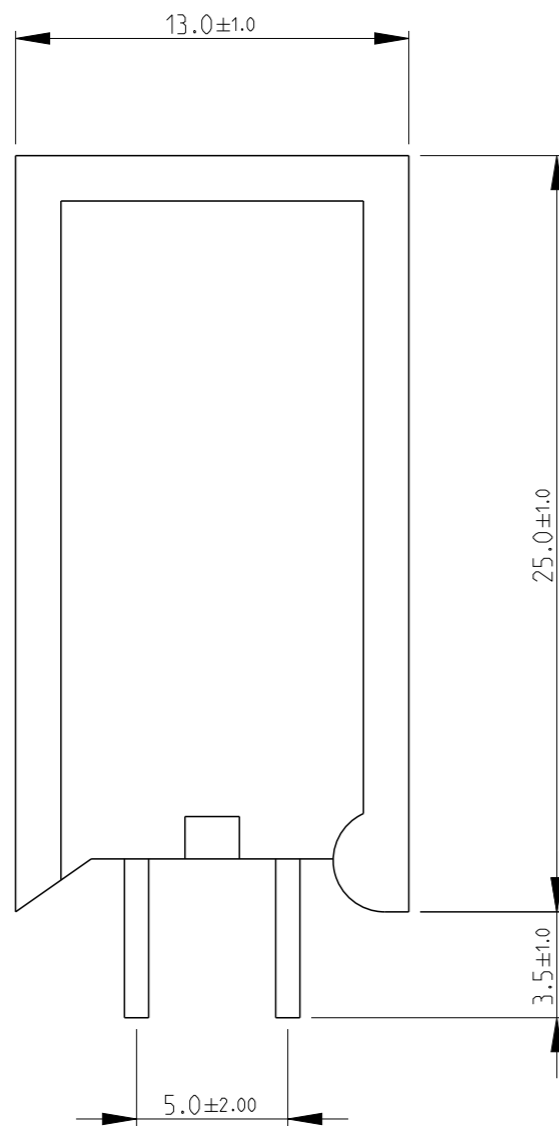

RoHS Compliant

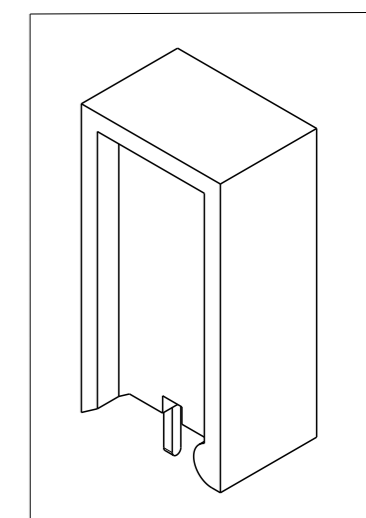

THIS DRAWING IS A CONTROLLED DOCUMENT.		DWN PARUSURAM.T 12OCT2010		
DIMENSIONS: mm		CHK ALLAN.P 12OCT2010		
TOLERANCES UNLESS OTHERWISE SPECIFIED:		APVD STEPHEN.P 12OCT2010	NAME HIGH POWER RESISTORS SERIES SQM5	
		PRODUCT SPEC -	RESTRICTED TO -	
MATERIAL -		FINISH -	APPLICATION SPEC -	SCALE 4:1
		WEIGHT -	SIZE A3	SHEET 1 OF 3
		CUSTOMER DRAWING	DRAWING NO C=1623782	REV BB1

P	LTR	DESCRIPTION	DATE	DWN	APVD
-		SEE SHEET 1	-	-	-

SQM5 TUBE PACKGING

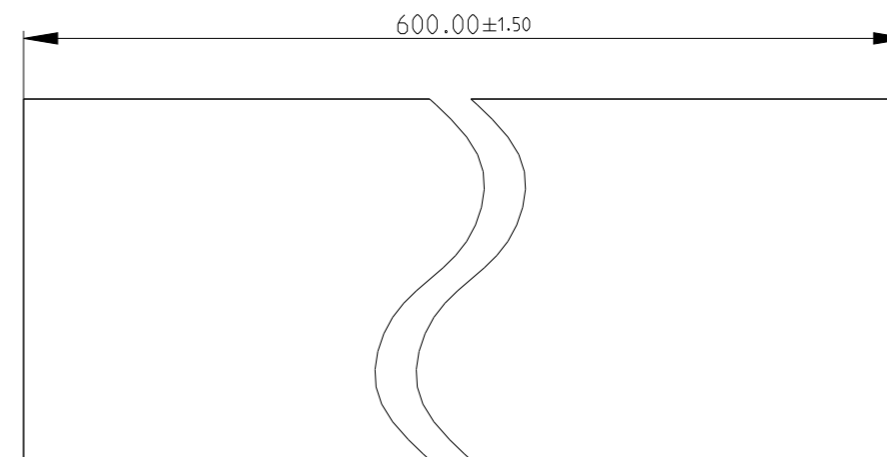
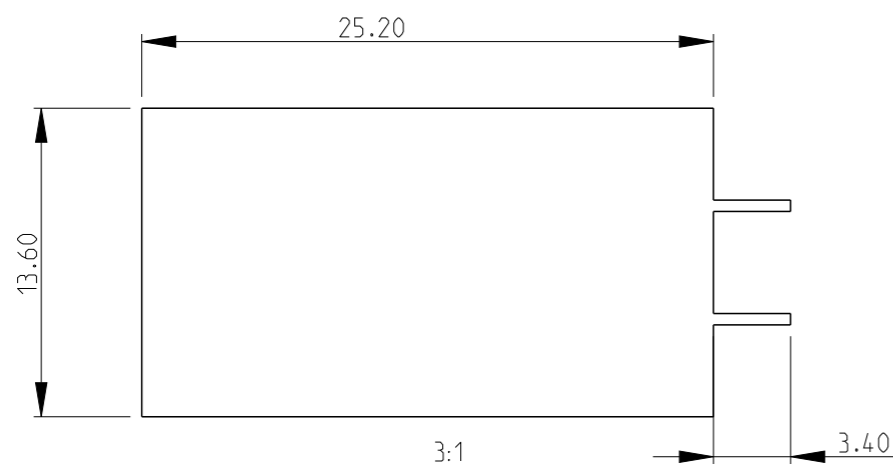
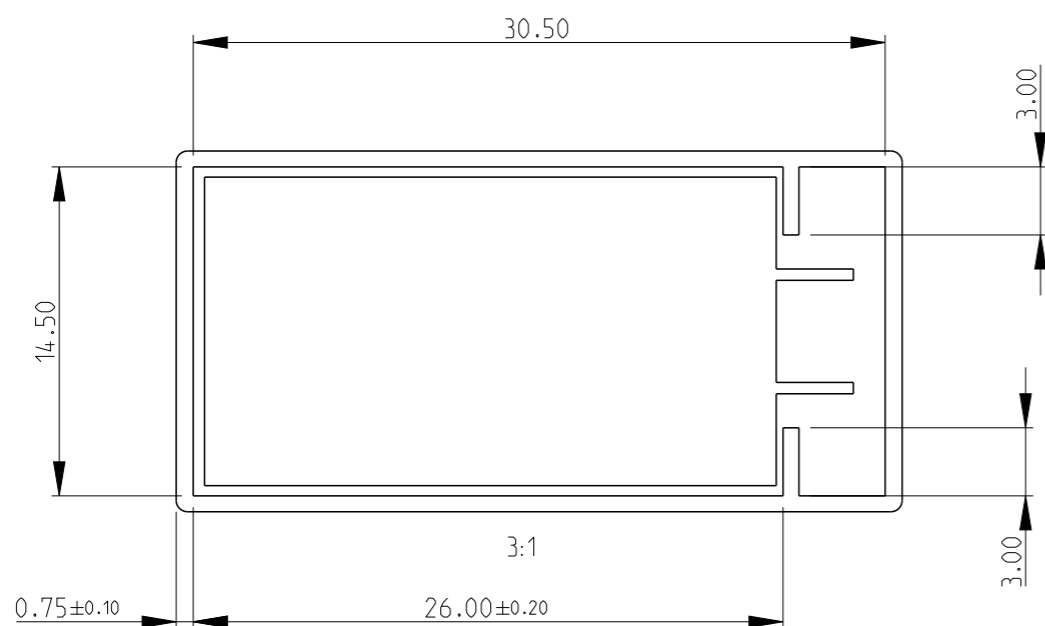

NOTES:

1. MATERIAL: 0.70±0.10THK. PVC(ANTISTATIC 10<sup>8</sup>~10<sup>11</sup>. COLOUR:TRANSPARENCE.
2. GENERAL TOLERANCES ±0.20 UNLESS OTHERWISE SPECIFIED.
3. PLASTIC PLUG/NAIL: TPR A TUBE TO FIT TWO PLUGS.
4. 60PCS.
5. THE TUBE PACKAGE IS MADE FROM PVC WHICH IS NOT HALOGEN-FREE.

SCHEDULE-TUBE PACKAGED PARTS

ITEM No	TE PART NUMBER	ALIAS	DESCRIPTION	ELEMENT TYPE
1	3-1623782-1	SQMW53R9JTUBE	SQM5 3R9 5% TUBE	WIRE
2	2-1623782-9	SQMR5220RJTUBE	SQM5 220R 5% TUBE	METAL FILM
3	3-1623782-0	SQMR522KJTUBE	SQM5 22K 5% TUBE	METAL FILM

THIS DRAWING IS A CONTROLLED DOCUMENT.		DWN PARUSURAM.T 12OCT2010		
DIMENSIONS: mm		CHK ALLAN.P 12OCT2010		
TOLERANCES UNLESS OTHERWISE SPECIFIED:		APVD STEPHEN.P 12OCT2010	NAME HIGH POWER RESISTORS SERIES SQM5	
		PRODUCT SPEC -	RESTRICTED TO -	
MATERIAL -		FINISH -	APPLICATION SPEC -	SIZE A3
		WEIGHT -	CAGE CODE 00779	DRAWING NO C-1623782
CUSTOMER DRAWING			SCALE 4:1	SHEET 2 OF 3
			REV BB1	

REVISIONS

P	LTR	DESCRIPTION	DATE	DWN	APVD
	-	SEE SHEET 1	-	-	-

SCHEDULE				
TCPN	CATALOGUE NUMBER	PART DESCRIPTION	ELEMENT	PACKAGING
1623782-1	SQMR510KJ	SQM5 10K 5% (METAL FILM)	Metal Film	Bulk
1623782-2	SQMR511KJ	SQM5 11K 5% (METAL FILM)	Metal Film	Bulk
1623782-3	SQMR515KJ	SQM5 15K 5% (METAL FILM)	Metal Film	Bulk
1623782-4	SQMR51K0J	SQM5 1K0 5% (METAL FILM)	Metal Film	Bulk
1623782-5	SQMR51K5J	SQM5 1K5 5% (METAL FILM)	Metal Film	Bulk
1623782-6	SQMR5220R	SQM5 220R 5% (METAL FILM)	Metal Film	Bulk
1623782-7	SQMR522KJ	SQM5 22K 5% (METAL FILM)	Metal Film	Bulk
1623782-8	SQMR52K2J	SQM5 2K2 5% (METAL FILM)	Metal Film	Bulk
1623782-9	SQMR530KJ	SQM5 30K 5% (METAL FILM)	Metal Film	Bulk
1-1623782-0	SQMR5330R	SQM5 330R 5% (METAL FILM)	Metal Film	Bulk
1-1623782-1	SQMR533KJ	SQM5 33K 5% (METAL FILM)	Metal Film	Bulk
1-1623782-2	SQMR5470R	SQM5 470R 5% (METAL FILM)	Metal Film	Bulk
1-1623782-3	SQMR547KJ	SQM5 47K 5% (METAL FILM)	Metal Film	Bulk
1-1623782-4	SQMR54K7J	SQM5 4K7 5% (METAL FILM)	Metal Film	Bulk
1-1623782-5	SQMR5680R	SQM5 680R 5% (METAL FILM)	Metal Film	Bulk
1-1623782-6	SQMR568KJ	SQM5 68K 5% (METAL FILM)	Metal Film	Bulk
1-1623782-7	SQMR56K8J	SQM5 6K8 5% (METAL FILM)	Metal Film	Bulk
1-1623782-8	SQMR518KJ	SQM5 18K 5% (METAL FILM)	Metal Film	Bulk
1-1623782-9	SQMR53K3J	SQM5 3K3 5% (METAL FILM)	Metal Film	Bulk
2-1623782-0	SQMR539KJ	SQM5 39K 5% (METAL FILM)	Metal Film	Bulk
2-1623782-1	SQMR5390R	SQM5 390R 5% (METAL FILM)	Metal Film	Bulk
2-1623782-2	SQMR512KJ	SQM5 12K 5% (METAL FILM)	Metal Film	Bulk
2-1623782-3	SQMR55K6J	SQM5 5K6 5% (METAL FILM)	Metal Film	Bulk
2-1623782-4	SQMR58K2J	SQM5 8K2 5% (METAL FILM)	Metal Film	Bulk
2-1623782-5	SQMR520KJ	SQM5 20K 5% (METAL FILM)	Metal Film	Bulk
2-1623782-6	SQMR5330RF	SQM5 330R 1% (METAL FILM)	Metal Film	Bulk
2-1623782-7	SQMR575KJ	SQM5 75K 5% (METAL FILM)	Metal Film	Bulk
2-1623782-8	SQMR5620R	SQM5 620R 5% (METAL FILM)	Metal Film	Bulk
2-1623782-9	SQMR5220RJTUBE	SQM5 220R 5% (METAL FILM) TUBE	Metal Film	Tube
3-1623782-0	SQMR522KJTUBE	SQM5 22K 5% (METAL FILM) TUBE	Metal Film	Tube
3-1623782-1	SQMW53R9JTUBE	SQM5 3R9 5% (WIRE) TUBE	Wire	Tube
3-1623782-2	SQMR582KJ	SQM5 82K 5% (METAL FILM)	Metal Film	Bulk

THIS DRAWING IS A CONTROLLED DOCUMENT.

DIMENSIONS:  
mm

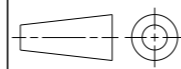

MATERIAL

TOLERANCES UNLESS OTHERWISE SPECIFIED:

- 0 PLC ±0.2
- 1 PLC ±0.1
- 2 PLC ±-
- 3 PLC ±-
- 4 PLC ±-
- ANGLES ±5°
- FINISH -

DWN 12OCT2010  
PARUSURAM.T

CHK 12OCT2010  
ALLAN.P

APVD 12OCT2010  
STEPHEN.P

PRODUCT SPEC

APPLICATION SPEC

WEIGHT

CUSTOMER DRAWING



NAME  
HIGH POWER RESISTORS  
SERIES SQM5

SIZE CAGE CODE DRAWING NO RESTRICTED TO

A3 00779 C-1623782

SCALE 4:1 SHEET 3 OF 3 REV BB1