

REVISIONS					
P	LTR	DESCRIPTION	DATE	DWN	APVD
	BC1	ECR-15-002767	23FEB2015	KR	TN

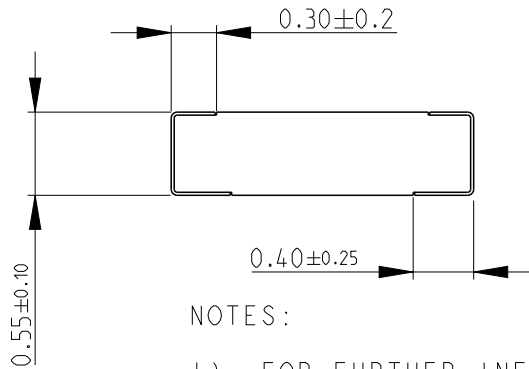
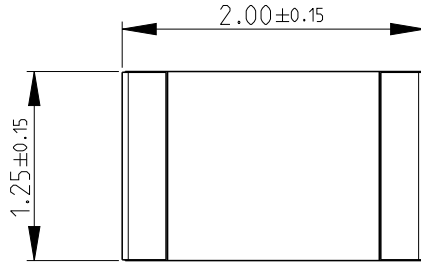

NOTES:

- 1) FOR FURTHER INFORMATION SEE DATA SHEET FOR RN73 SERIES-HIGH PRECISION RESISTORS (SMD)
- 2) 250 PER REEL PACKING SPEC NO LONGER AVAILABLE

RECOMMENDED LAND PATTERN

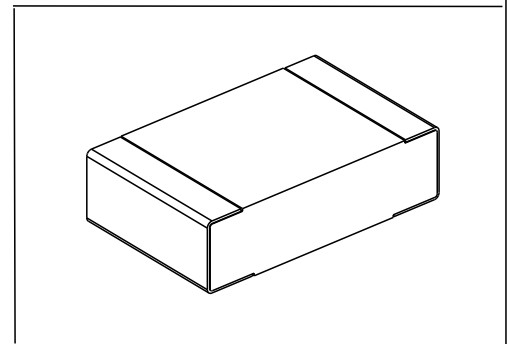
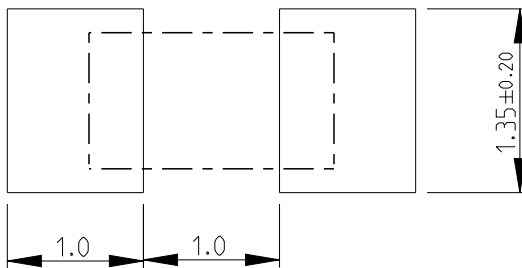

2010

RELEASED FOR PUBLICATION

ALL RIGHTS RESERVED.

THIS DRAWING IS UNPUBLISHED.

BY -

© COPYRIGHT 2010

DIMENSIONS: mm		DWN PARUSURAM.T 13NOV2010	MATERIAL -	FINISH -			
TOLERANCES UNLESS OTHERWISE SPECIFIED:		CHK ALLAN.P 10NOV2010	TE Connectivity				
0 PLC ±0.2 1 PLC ±0.1 2 PLC ± 3 PLC ± 4 PLC ± ANGLES ±5°		APVD STEPHEN.P 10NOV2010					
		PRODUCT SPEC -	NAME HIGH PRECISION RESISTORS (SMD) SERIES RN73 2A				
		APPLICATION SPEC -	SIZE A4	CAGE CODE 00779	DRAWING NO C-1676319	RESTRICTED TO -	
		WEIGHT -	Customer Drawing		SCALE 20:1	SHEET 1 OF 1	REV BC1