

LOC	DISP	REVISIONS			
NO	DATE	DESCRIPTION	DATE	BY	APP'D
□		RELEASED (FC00-0293-04)	30/NOV/04	YD	C.S
△		REVISED (ECR-09-024076)	04/NOV/09	YM	HG

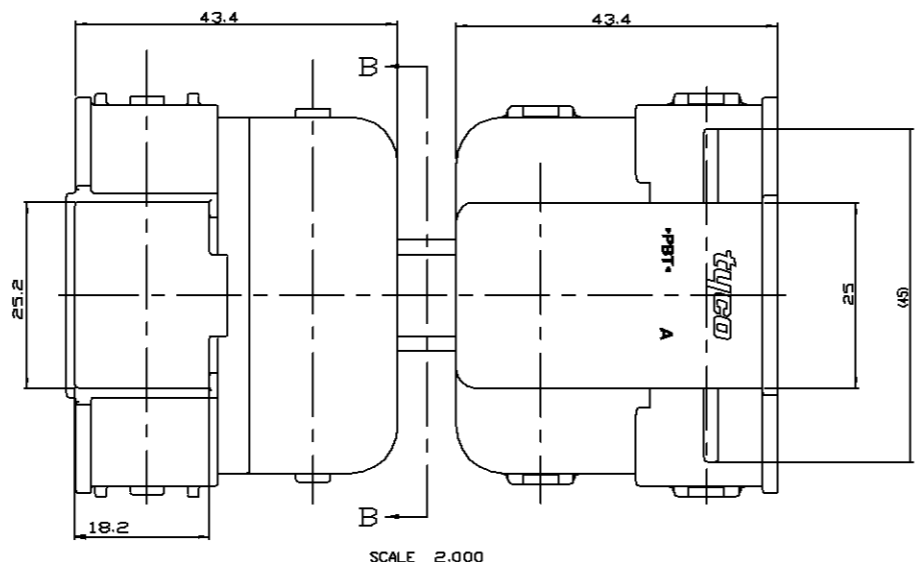

SCALE 2.000

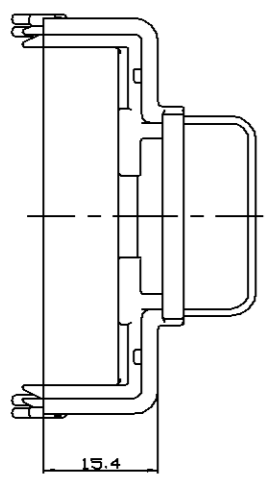
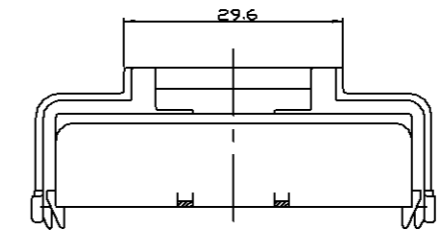
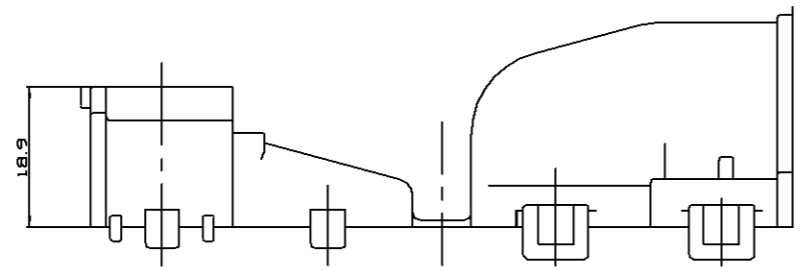
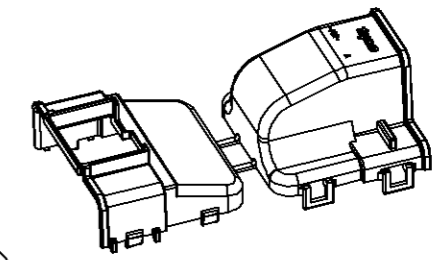
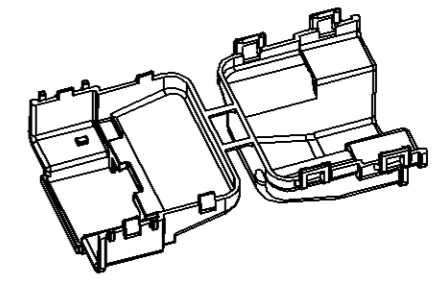
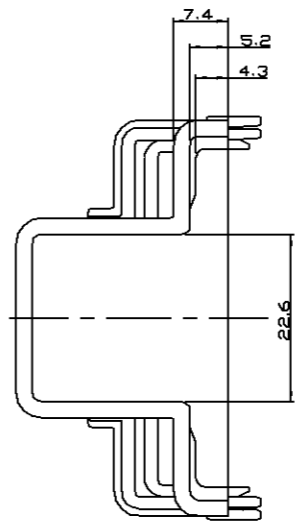

SECTION B-B  
 SCALE 2.000

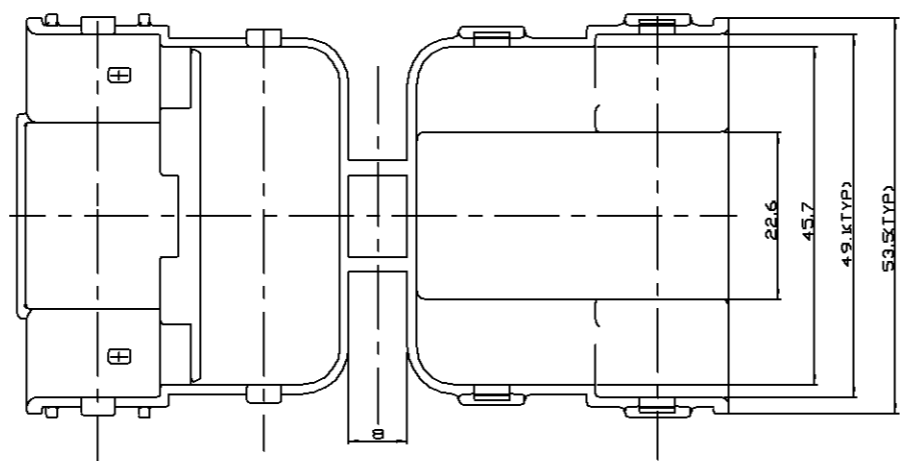

- NOTES :
1. ALL RAD II ARE 0.3 EXCEPT AS INDICATED.
  2. 0.15 MAX WARPAGE AND 0.2 MAX FLASH ARE PERMISSIBLE.
  3. TRADE MARK IS BASED ON 1-999903-3 0.2 RAISED.  
 -RECYCLE MARK : 3.0 CHARACTERS 0.2 RAISED.  
 -CAVITY MARK : 3.0 CHARACTERS 0.2 RAISED.
  4. ALL CAVITIES ARE TYPICAL.
  5. GENERAL TOLERANCE : ±0.3 , ±1°.

BLACK	(A) PBT	COVER HSG FOR 39P&42P	0-1743101-2
COLOR	MATERIAL	DESCRIPTION	P/N

DIMENSIONS MM 	TOLERANCES UNLESS OTHERWISE SPECIFIED 0 PL/C ± 1 PL/C ± 2 PL/C ± 3 PL/C ± 4 PL/C ± ANGLES ± FINISH	DWN YN LEE CHK JW JUNG APVD HG CHO PRODUCT SPEC APPLICATION SPEC VEIGH	Tyco Electronics kyungsan, korea U-TURN COVER HSG FOR HYB 39P & 42P CAP ASS'Y CONN(RLIF) SIZE CAGE CODE (BRANDING NO) 1743101 SCALE 2:1 SHEET 1 OF 1 REV A
----------------------	--	--	---