

LOC	DIST	REVISIONS					
E	B	P	LTR	DESCRIPTION	DATE	DWN	APVD
			BA	NEW RELEASE	01SEP2010	PT	St.P

FOR FURTHER INFORMATION SEE DATA SHEET FOR
RN73 SERIES-HIGH PRECISION RESISTORS (SMD)

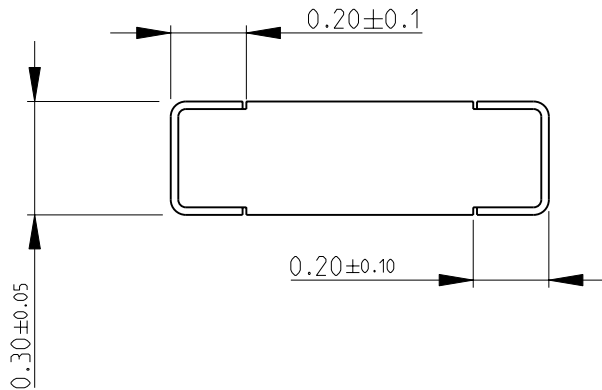

RECOMMENDED LAND PATTERN

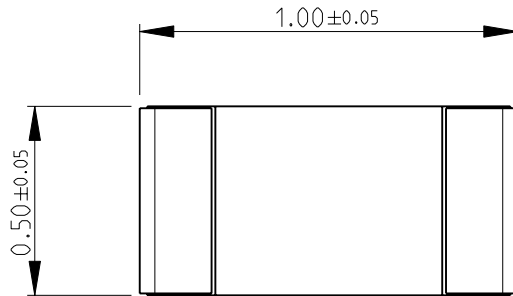
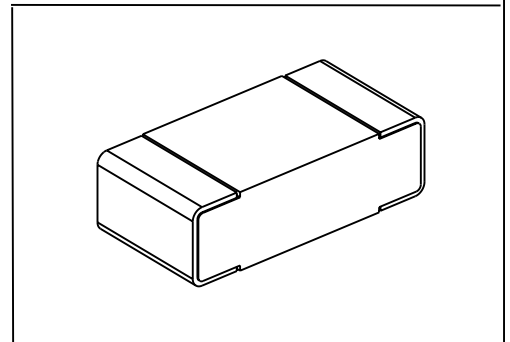
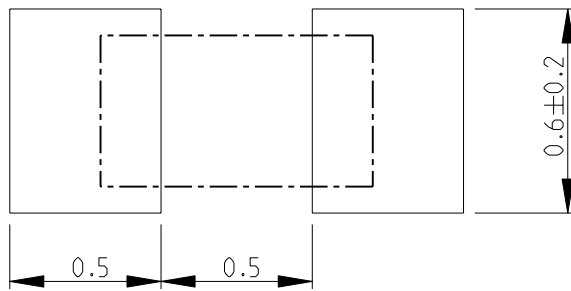

2010

RELEASED FOR PUBLICATION

THIS DRAWING IS UNPUBLISHED.

BY TYCO ELECTRONICS CORPORATION. ALL RIGHTS RESERVED.

DIMENSIONS: mm	DWN	PARUSURAM.T	01SEP2010	MATERIAL	-	FINISH	-
	CHK	ALLAN.P	01SEP2010	Tyco Electronics Corporation Dorcan, Swindon, SN3 5HH			
TOLERANCES UNLESS OTHERWISE SPECIFIED:	APVD	STEPHEN.P	01SEP2010				
0 PLC ±0.2	PRODUCT SPEC	-	-	NAME			
1 PLC ±0.1	APPLICATION SPEC	-	-	HIGH PRECISION RESISTORS (SMD)			
2 PLC ±-	WEIGHT	-	-	SERIES RN73 1E			
3 PLC ±-				SIZE	CAGE CODE	DRAWING NO	RESTRICTED TO
4 PLC ±-				A 4	00779	©- 1879130	-
ANGLES ±5°				CUSTOMER DRAWING			
				SCALE	20:1	SHEET	1 OF 1
							REV BA