

REVISIONS

P	LTR	DESCRIPTION	DATE	DWN	APVD
	A	NEW DRAWING	04JUL2020	GK	IR

NOTES:

- 1. 1SET212002R0000 AS SHOWN.
- 2. MATERIALS:

CONTACT: PHOSPHOR BRONZE, TIN PLATED
 HOUSING: PC NOT GLASS FILLED;
 COLOUR-CLEAR
 BUTTONS: PC NOT GLASS FILLED;
 COLOUR-YELLOW AND BLUE

- 3 LASER MARKING:
 - KEMA
 - UL
 - TE LOGO
 - TE PART NUMBER
 - DATE CODE

4 LASER MARKING: IP x5/x7

DIMENSIONS BEFORE APPLICATION

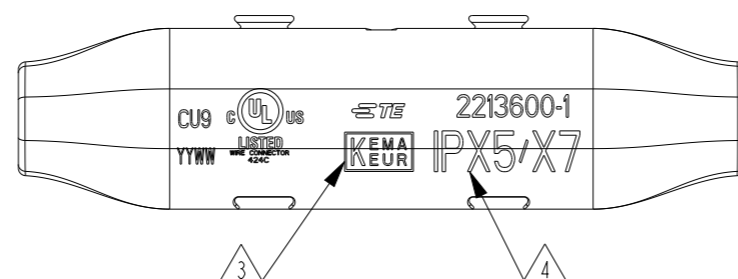
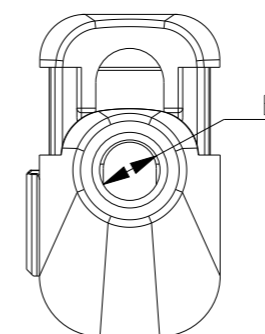
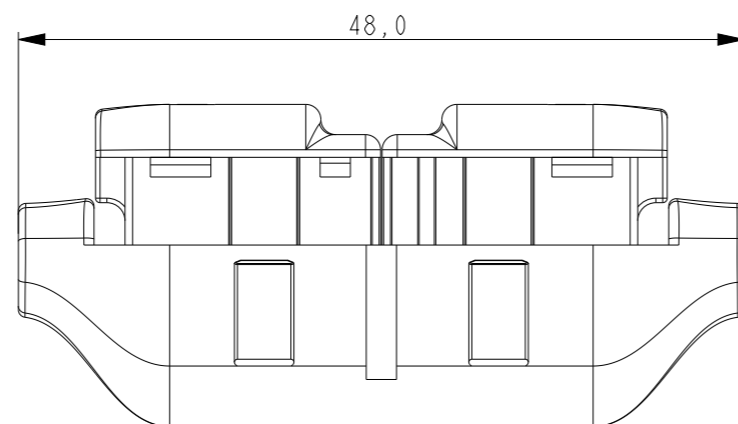
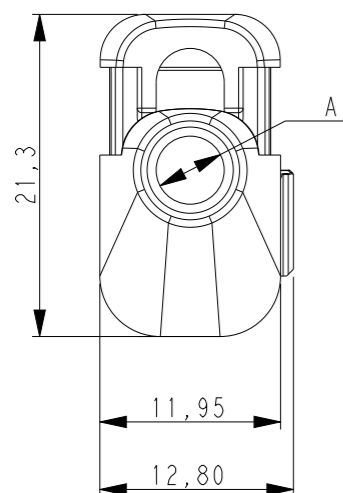
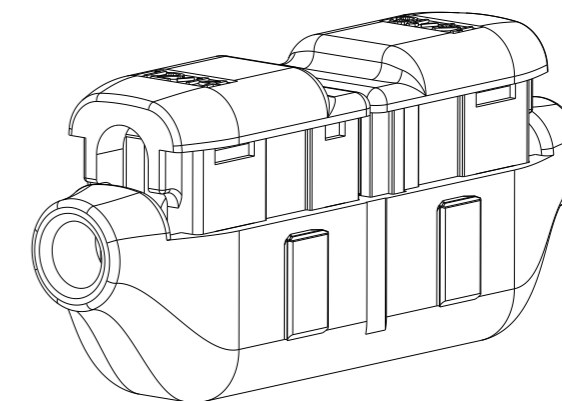
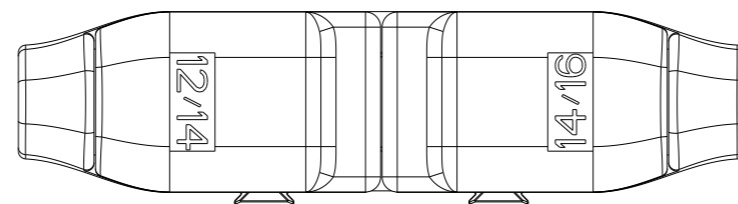

SEALED/4	A=4.5 B=4.0	12/14 TO 14/16	1SET212002R0000	2213600-1
SEALING	WIRE ENTRY	WIRE SIZE	ENTRELEC PN	TE PN

THIS DRAWING IS A CONTROLLED DOCUMENT.
 DIMENSIONING AND TOLERANCING PER ASME Y14.5M-2009.

DIMENSIONS:	TOLERANCES UNLESS OTHERWISE SPECIFIED:
mm	
	0 PLC ±-
	1 PLC ±0,2
	2 PLC ±0,2
	3 PLC ±-
	4 PLC ±-
	ANGLES ±-
MATERIAL	FINISH
-	-
-	-

DWN	04JUL2020
CHK	GOPALAKRISHNA HV
APVD	04JUL2020
NAME	IAN RIDGEWAY
PRODUCT SPEC	108-133061
APPLICATION SPEC	114-133061
WEIGHT	-
CUSTOMER DRAWING	

TE Connectivity		NAME		RESTRICTED TO
		ISW40-25-L		
SIZE	CAGE CODE	DRAWING NO		
A3	00779	1SET212002R0000		
SCALE		SHEET	OF	REV
2:1		1	3	A



REVISIONS

P	LTR	DESCRIPTION	DATE	DWN	APVD
-	-	SEE SHEET 1	-	-	-

DIMENSIONS AFTER APPLICATION

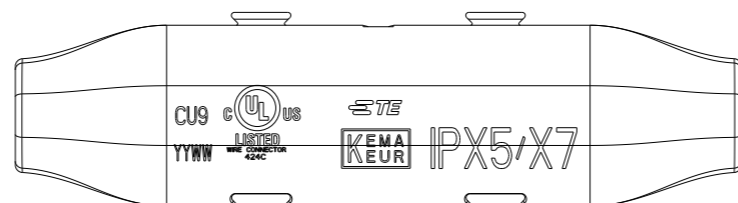
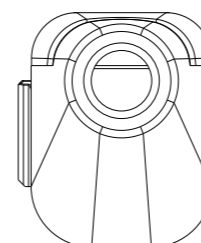
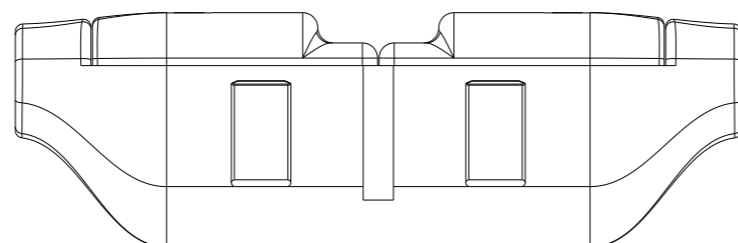
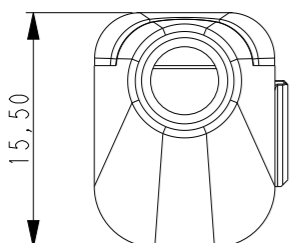
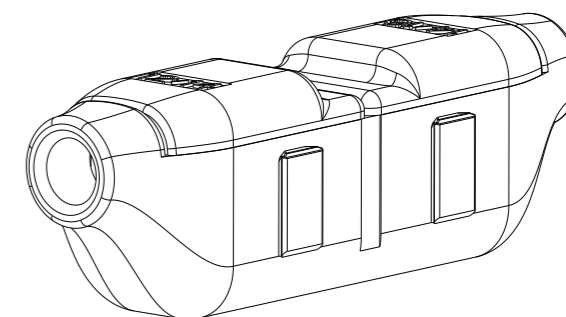
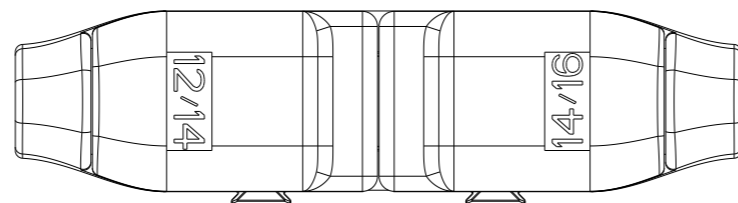
NOTE:
1. 1SET212002R0000 AS SHOWN.



THIS DRAWING IS A CONTROLLED DOCUMENT.		DWN 04JUL2020 GOPALAKRISHNA HV	 TE Connectivity	
		CHK 04JUL2020 IAN RIDGEWAY		
DIMENSIONS: mm		APVD 04JUL2020 IAN RIDGEWAY	NAME ISW40-25-L	
		PRODUCT SPEC 108-133061	-	
TOLERANCES UNLESS OTHERWISE SPECIFIED: 0 PLC ±- 1 PLC ±0,2 2 PLC ±0,2 3 PLC ±- 4 PLC ±- ANGLES ±-		APPLICATION SPEC 114-133061	SIZE A3	CAGE CODE 00779
MATERIAL -		FINISH -	DRAWING NO C-1SET212002R0000	RESTRICTED TO -
		WEIGHT -	SCALE 2:1 SHEET 2 OF 3 REV A	
		CUSTOMER DRAWING		

REVISIONS

P	LTR	DESCRIPTION	DATE	DWN	APVD
-	-	SEE SHEET 1	-	-	-

DIMENSIONS AFTER STACKING

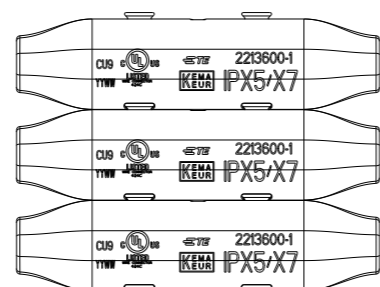
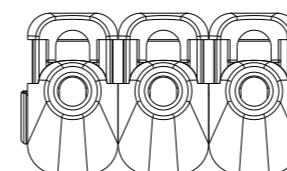
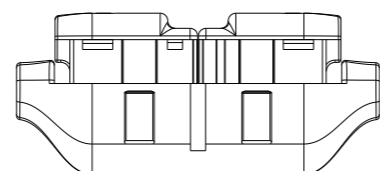
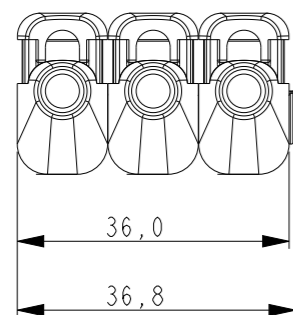
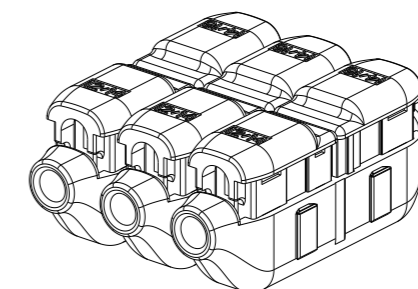
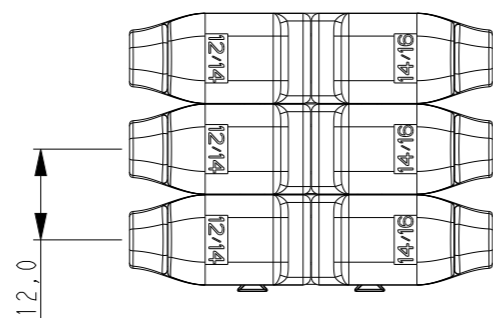

THIS DRAWING IS A CONTROLLED DOCUMENT.

DIMENSIONS:
mm

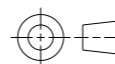

TOLERANCES UNLESS OTHERWISE SPECIFIED:

0 PLC	±-
1 PLC	±0,2
2 PLC	±0,2
3 PLC	±-
4 PLC	±-
ANGLES	±-

MATERIAL

FINISH

DWN 04JUL2020

CHK 04JUL2020

APVD 04JUL2020

IAN RIDGEWAY

PRODUCT SPEC

108-133061

APPLICATION SPEC

114-133061

WEIGHT

-

CUSTOMER DRAWING



TE Connectivity

NAME

ISW40-25-L

-

-

SIZE

A3

CAGE CODE

00779

DRAWING NO

1SET212002R0000

RESTRICTED TO

-

SCALE 2:1

SHEET 3 OF 3

REV A