

REVISIONS

P	LTR	DESCRIPTION	DATE	DWN	APVD
	A	NEW DRAWING	16 JUL 2020	GK	IR

DIMENSIONS BEFORE APPLICATION

NOTES:

- 1. ISET212003R0000 AS SHOWN.
- 2. MATERIALS:

CONTACT: PHOSPHOR BRONZE, TIN PLATED
 HOUSING: PC NOT GLASS FILLED;
 COLOUR - CLEAR
 BUTTONS: PC NOT GLASS FILLED;
 COLOUR - YELLOW AND RED

3 LASER MARKING:

- KEMA
- UL
- TE LOGO
- TE PART NUMBER
- DATE CODE

4 LASER MARKING: IP x5/x7

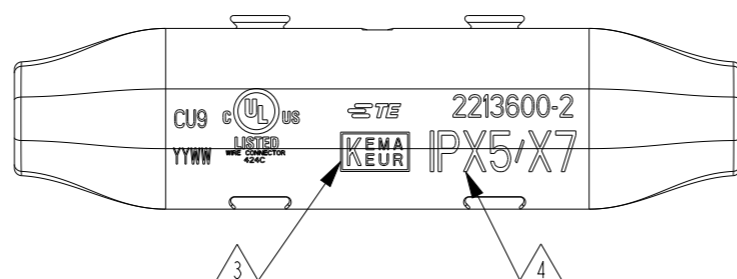
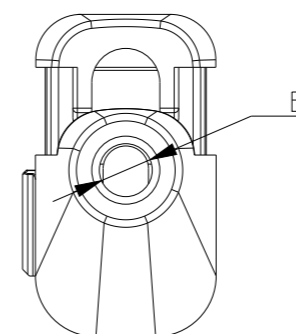
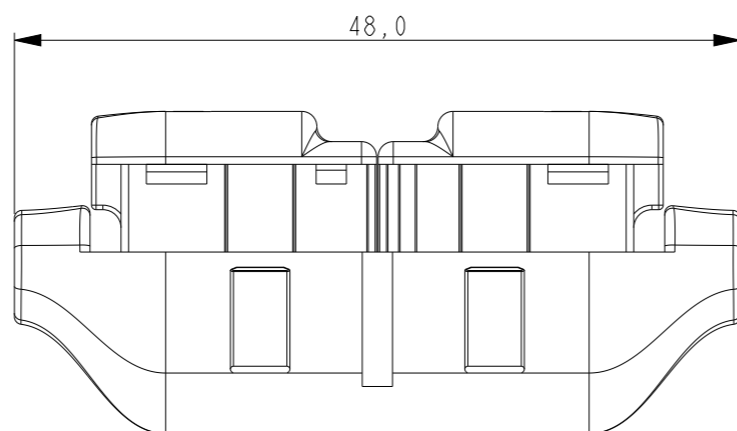
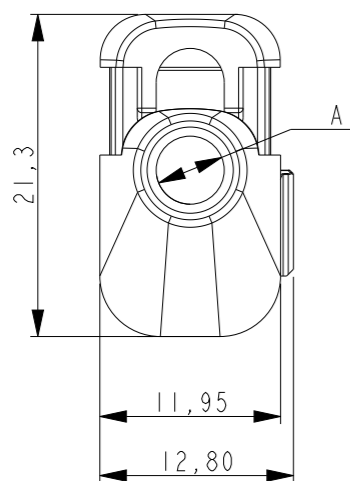
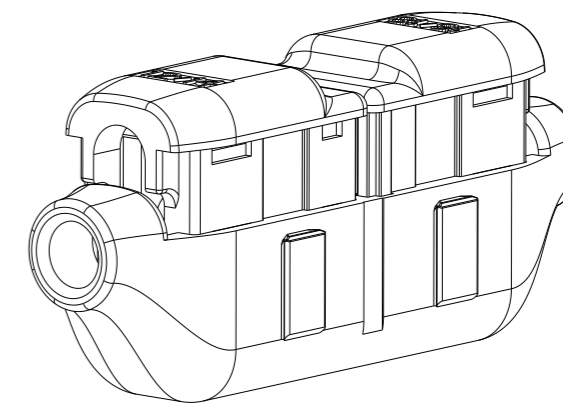
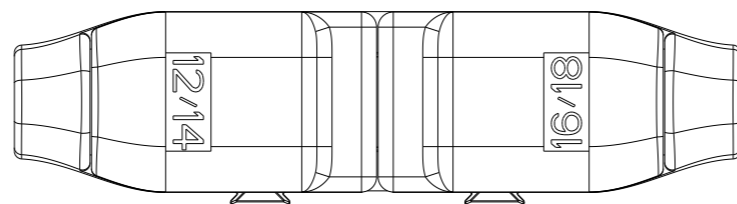

SEALED/4	A=4.5 B=3.5	12/14 TO 16/18	ISET212003R0000	2213600-2
SEALING	WIRE ENTRY	WIRE SIZE	ENTRELEC PN	TE PN

THIS DRAWING IS A CONTROLLED DOCUMENT.
 DIMENSIONING AND TOLERANCING PER ASME Y14.5M-2009.

DIMENSIONS:	TOLERANCES UNLESS OTHERWISE SPECIFIED:
mm	
	0 PLC ±-
	1 PLC ±0,2
	2 PLC ±0,2
	3 PLC ±-
	4 PLC ±-
	ANGLES ±-
MATERIAL	FINISH
-	-
-	-

DWN	16 JUL 2020
CHK	16 JUL 2020
APVD	16 JUL 2020
NAME	IAN RIDGEWAY
PRODUCT SPEC	108-133061
APPLICATION SPEC	114-133061
WEIGHT	-
CUSTOMER DRAWING	

TE Connectivity		NAME		RESTRICTED TO
		ISW40-15-L		
SIZE	CAGE CODE	DRAWING NO	-	
A3	00779	©-ISET212003R0000	-	
SCALE		SHEET	OF	REV
2:1		1	3	A

© - BY TYCO ELECTRONICS CORPORATION.

REVISIONS

P	LTR	DESCRIPTION	DATE	DWN	APVD
-	-	SEE SHEET 1	-	-	-

DIMENSIONS AFTER APPLICATION

NOTE:
1. ISET212003R0000 AS SHOWN.

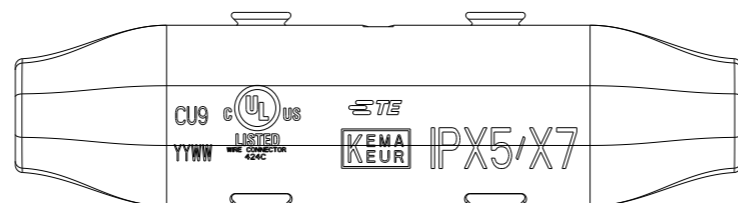
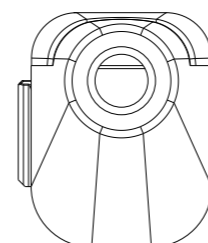
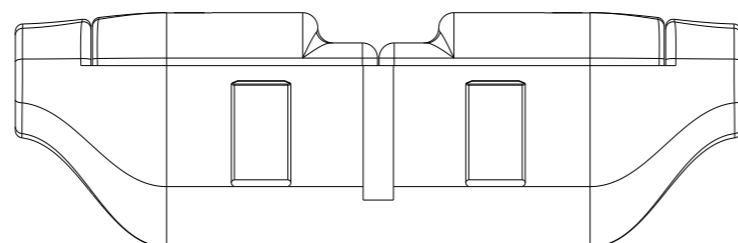
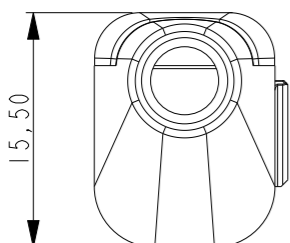
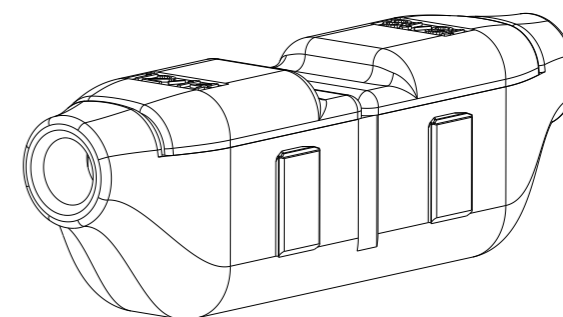
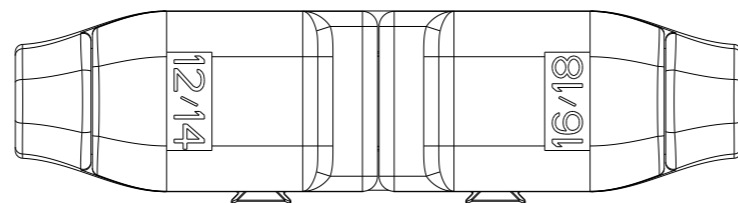

THIS DRAWING IS A CONTROLLED DOCUMENT.

DIMENSIONS: mm	TOLERANCES UNLESS OTHERWISE SPECIFIED:
	0 PLC ±-
	1 PLC ±0,2
	2 PLC ±0,2
	3 PLC ±-
	4 PLC ±-
	ANGLES ±-
MATERIAL	FINISH
-	-
-	-

DWN	16 JUL 2020
CHK	16 JUL 2020
APVD	16 JUL 2020
PRODUCT SPEC	108-133061
APPLICATION SPEC	114-133061
WEIGHT	-
CUSTOMER DRAWING	

TE Connectivity		NAME		RESTRICTED TO
		ISW40-15-L		
SIZE	CAGE CODE	DRAWING NO	-	
A3	00779	©-ISET212003R0000	-	
SCALE		SHEET	OF	REV
5:1		2	3	A

REVISIONS

P	LTR	DESCRIPTION	DATE	DWN	APVD
-	-	SEE SHEET 1	-	-	-

DIMENSIONS AFTER STACKING

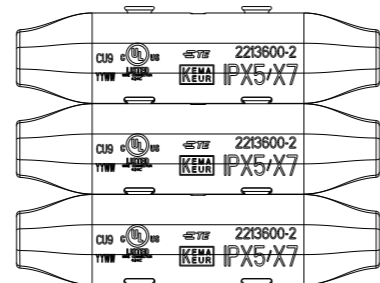
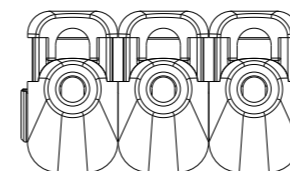
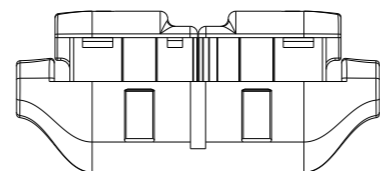
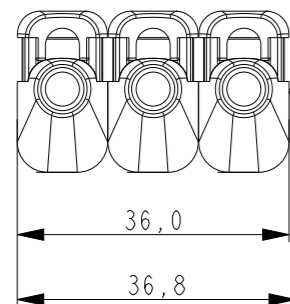
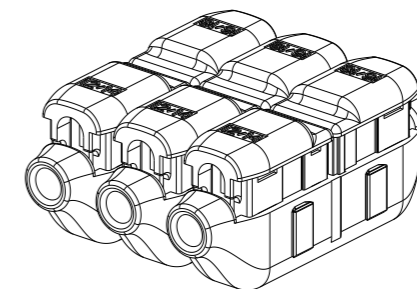
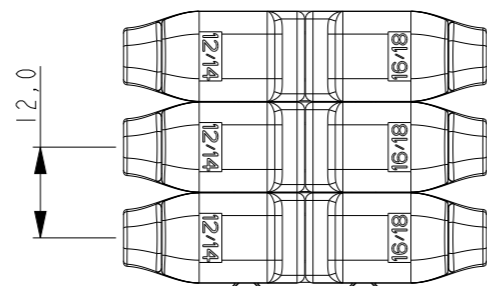

THIS DRAWING IS A CONTROLLED DOCUMENT.

DIMENSIONS:
mm

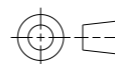

TOLERANCES UNLESS OTHERWISE SPECIFIED:

0 PLC	±-
1 PLC	±0,2
2 PLC	±0,2
3 PLC	±-
4 PLC	±-
ANGLES	±-

MATERIAL
-

FINISH
-

DWN 16 JUL 2020
GOPALAKRISHNA HV

CHK 16 JUL 2020
IAN RIDGEWAY

APVD 16 JUL 2020
IAN RIDGEWAY

PRODUCT SPEC
108-133061

APPLICATION SPEC
114-133061

WEIGHT
-

CUSTOMER DRAWING



TE Connectivity

NAME
ISW40-15-L

SIZE A3	CAGE CODE 00779	DRAWING NO C-1SET212003R0000	RESTRICTED TO -
------------	--------------------	---------------------------------	--------------------

SCALE 5:1 SHEET 3 OF 3 REV A