

REVISIONS

P	LTR	DESCRIPTION	DATE	DWN	APVD
	A	NEW DRAWING	16 JUL 2020	GK	IR

DIMENSIONS BEFORE APPLICATION

NOTES:

- 1. ISET212004R0000 AS SHOWN.
- 2. MATERIALS:

CONTACT: PHOSPHOR BRONZE, TIN PLATED
 HOUSING: PC NOT GLASS FILLED;
 COLOUR - CLEAR
 BUTTONS: PC NOT GLASS FILLED;
 COLOUR - BLUE AND RED

- 3 LASER MARKING:
 - KEMA
 - UL
 - TE LOGO
 - TE PART NUMBER
 - DATE CODE

4 LASER MARKING: IP x5/x7

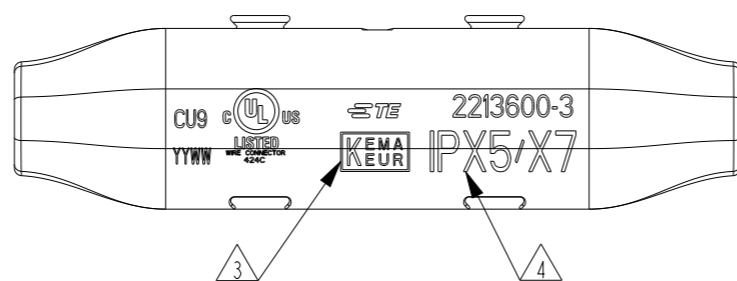
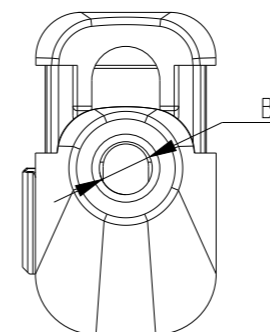
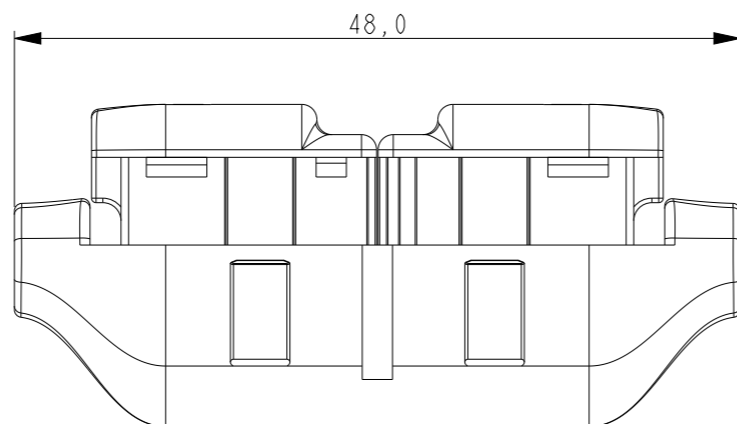
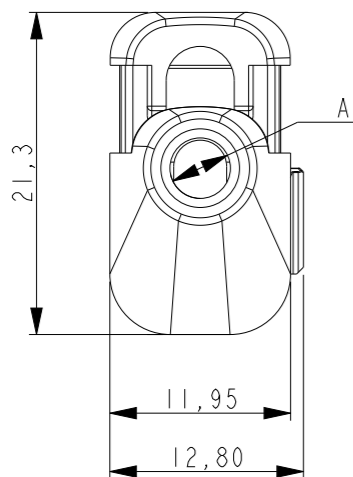
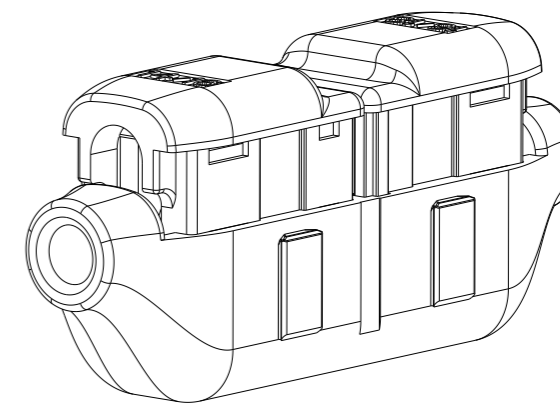
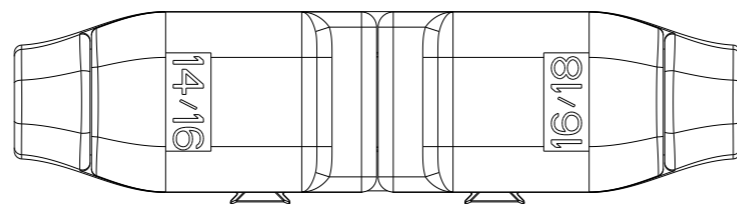

SEALED 4	A=4.0 B=3.5	14/16 TO 16/18	ISET212004R0000	2213600-3
SEALING	WIRE ENTRY	WIRE SIZE	ENTRELEC PN	TE PN

THIS DRAWING IS A CONTROLLED DOCUMENT.
 DIMENSIONING AND TOLERANCING PER ASME Y14.5M-2009.

DIMENSIONS:	TOLERANCES UNLESS OTHERWISE SPECIFIED:
mm	
	0 PLC ±-
	1 PLC ±0,2
	2 PLC ±0,2
	3 PLC ±-
	4 PLC ±-
	ANGLES ±-
MATERIAL	FINISH
-	-
-	-

DWN	16 JUL 2020	STE TE Connectivity	NAME ISW25-15-L		
CHK	16 JUL 2020				
APVD	16 JUL 2020				
IAN RIDGEWAY	IAN RIDGEWAY				
PRODUCT SPEC	108-133061	SIZE	CAGE CODE	DRAWING NO	RESTRICTED TO
APPLICATION SPEC	114-133061	A3	00779	©-ISET212004R0000	-
WEIGHT	-	CUSTOMER DRAWING	SCALE	SHEET	REV
			2:1	1 OF 3	A

© - BY TYCO ELECTRONICS CORPORATION.

REVISIONS

P	LTR	DESCRIPTION	DATE	DWN	APVD
-	-	SEE SHEET 1	-	-	-

DIMENSIONS AFTER APPLICATION

NOTE:
1. ISET212004R0000 AS SHOWN.

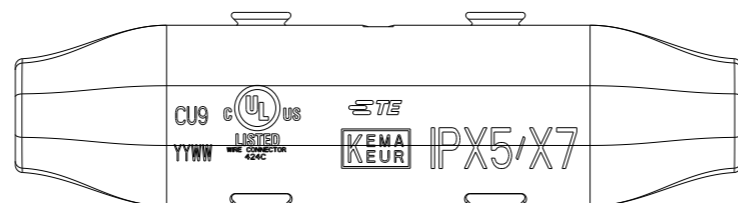
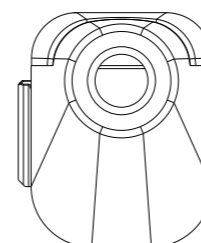
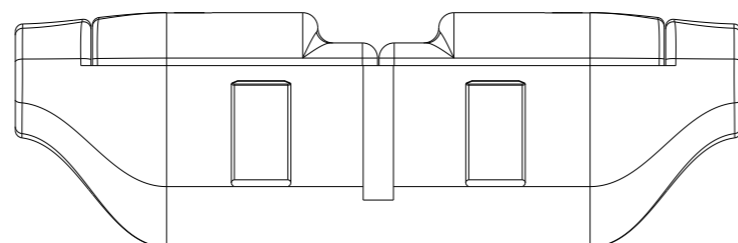
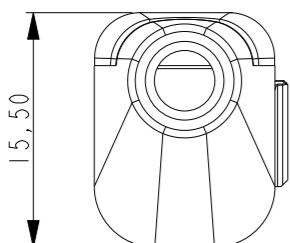
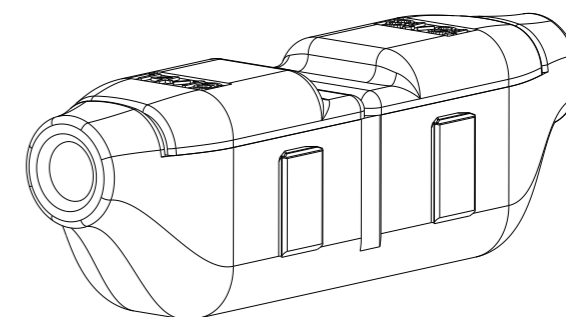
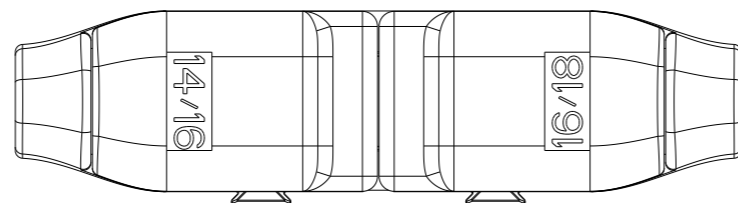

THIS DRAWING IS A CONTROLLED DOCUMENT.

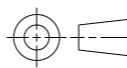
DIMENSIONS: mm	TOLERANCES UNLESS OTHERWISE SPECIFIED:
	0 PLC ±-
	1 PLC ±0,2
	2 PLC ±0,2
	3 PLC ±-
	4 PLC ±-
	ANGLES ±-
MATERIAL	FINISH
-	-
-	-

DWN	16 JUL 2020
CHK	GOPALAKRISHNA HV
APVD	16 JUL 2020
APVD	IAN RIDGEWAY
PRODUCT SPEC	108-133061
APPLICATION SPEC	114-133061
WEIGHT	-
CUSTOMER DRAWING	

 TE Connectivity		NAME		RESTRICTED TO
		ISW25-15-L		
SIZE	CAGE CODE	DRAWING NO	-	
A3	00779	©-ISET212004R0000	-	
SCALE		SHEET	OF	REV
5:1		2	3	A

REVISIONS

P	LTR	DESCRIPTION	DATE	DWN	APVD
-		SEE SHEET 1	-	-	-

DIMENSIONS AFTER STACKING

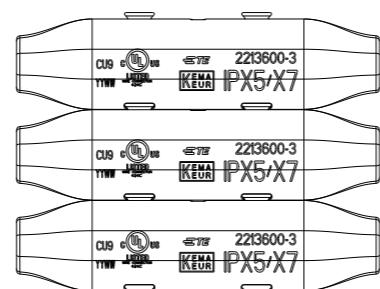
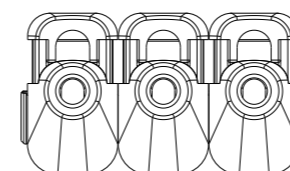
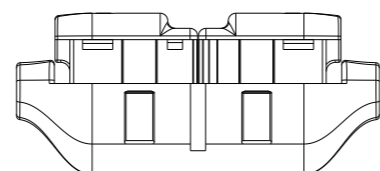
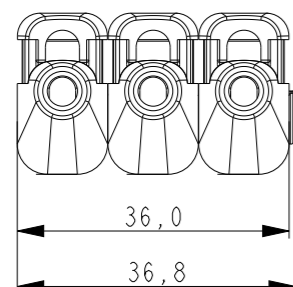
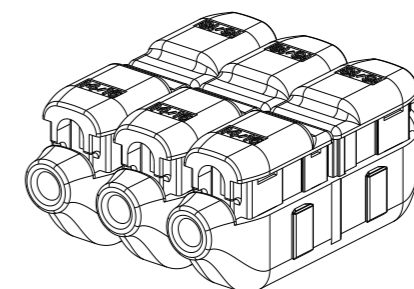
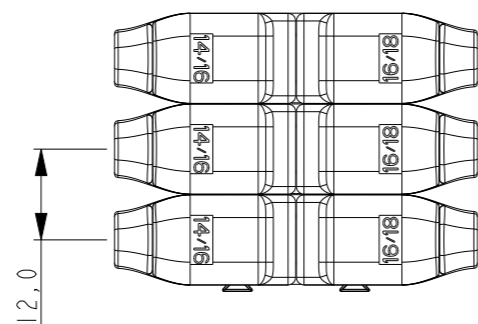

THIS DRAWING IS A CONTROLLED DOCUMENT.

DIMENSIONS:
mm

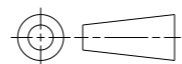

TOLERANCES UNLESS OTHERWISE SPECIFIED:

0 PLC	±-
1 PLC	±0,2
2 PLC	±0,2
3 PLC	±-
4 PLC	±-
ANGLES	±-

MATERIAL
-

FINISH
-

DWN 16 JUL 2020
GOPALAKRISHNA HV

CHK 16 JUL 2020
IAN RIDGEWAY

APVD 16 JUL 2020
IAN RIDGEWAY

PRODUCT SPEC
108-133061

APPLICATION SPEC
114-133061

WEIGHT
-

CUSTOMER DRAWING



TE Connectivity

NAME
ISW25-15-L

SIZE A3	CAGE CODE 00779	DRAWING NO C=1SET212004R0000	RESTRICTED TO -
------------	--------------------	---------------------------------	--------------------

SCALE 5:1	SHEET 3 OF 3	REV A
--------------	-----------------	----------