

REVISIONS

P	LTR	DESCRIPTION	DATE	DWN	APVD
	A	First release	17JUN2021	SL	VR

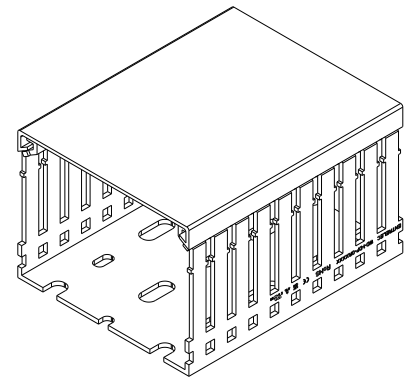
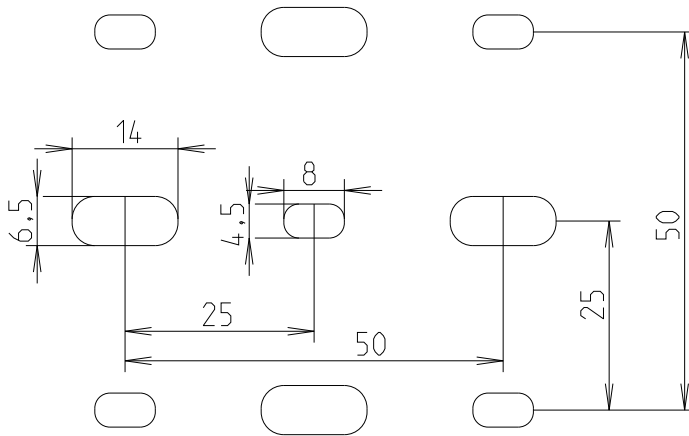
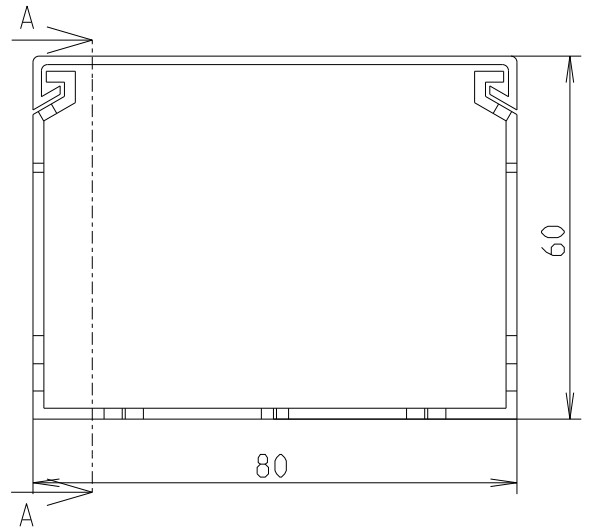
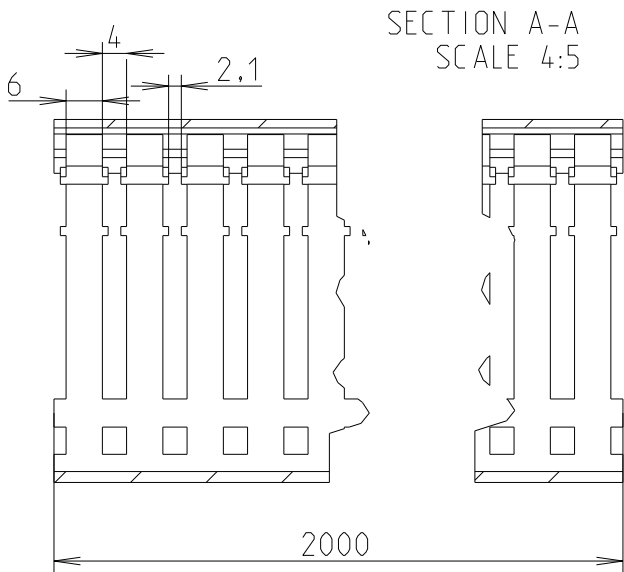

© 2021 TE Connectivity. All Rights Reserved.

1SET411022R0000

PART NO.

DIMENSIONS: mm	DWN 13-Sep-21 03:44:58 PM Deligny, Charlotte	MATERIAL	PVC	FINISH	-	
	CHK 2021-06-17 Seguin, Laurene					
TOLERANCES UNLESS OTHERWISE SPECIFIED:	APVD 2021-07-05 Villard, Romain					NAME
0 PLC ±	PRODUCT SPEC	-	SIZE	CAGE CODE	DRAWING NO	RESTRICTED TO
1 PLC ±1	APPLICATION SPEC	-	A 4	00779	©=1SNP300190-0402	-
2 PLC ±1	WEIGHT	-	CUSTOMER DRAWING			SCALE
3 PLC ±1						1:1
4 PLC ±1						SHEET
ANGLES ±						1 OF 1
						REV
						A1