

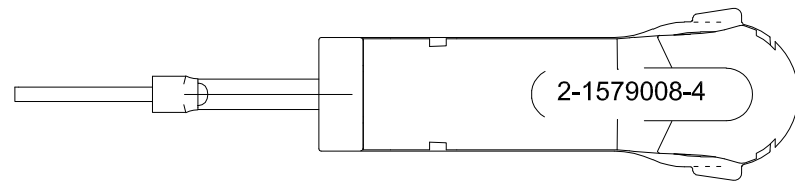
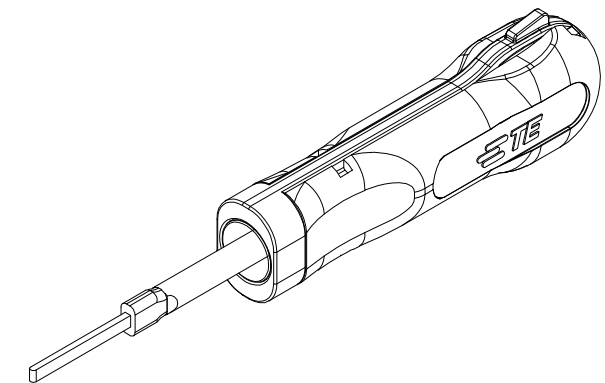
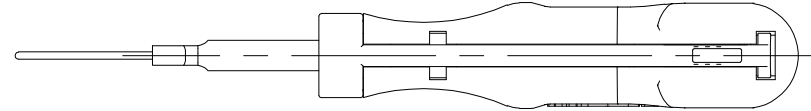
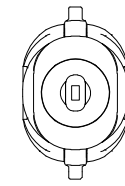
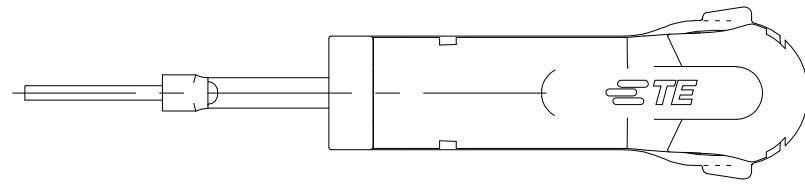

THIS DRAWING IS UNPUBLISHED.

RELEASED FOR PUBLICATION

© COPYRIGHT - BY TYCO ELECTRONICS CORPORATION. ALL INTERNATIONAL RIGHTS RESERVED.

LOC		DIST		REVISIONS			
P	LTR	DESCRIPTION		DATE	DWN	APVD	
	A1	ECR-17-009722		04JUL17	MG	BM	

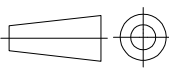

THIS DRAWING IS A CONTROLLED DOCUMENT.		DWN	06.11.2006		 <b>TE Connectivity</b>					
DIMENSIONS:		CHK	-							
mm		APVD	-		NAME					
		TOLERANCES UNLESS OTHERWISE SPECIFIED:		EXTRACTION TOOL						
		0 PLC	± -	Entriegelungswerkzeug						
MATERIAL		1 PLC	± -	PRODUCT SPEC						
		2 PLC	± -	APPLICATION SPEC						
		3 PLC	± -	SIZE	CAGE CODE	DRAWING NO	RESTRICTED TO			
		4 PLC	± -	00779	C-2-1579008-4	-				
FINISH		WEIGHT	0.016 kg		CUSTOMER DRAWING					
		SCALE		1:1		SHEET	1 OF 1		REV	A1

D

C

B

A