

THIS DRAWING IS UNPUBLISHED. RELEASED FOR PUBLICATION
 © COPYRIGHT - Tyco Electronics JAPAN G.K. ALL RIGHTS RESERVED.

LOC	DIST	REVISIONS					
		P	LTR	DESCRIPTION	DATE	DWN	APVD
ES	-	C		ECR-17-006884	12MAY2017	B.L	C.W

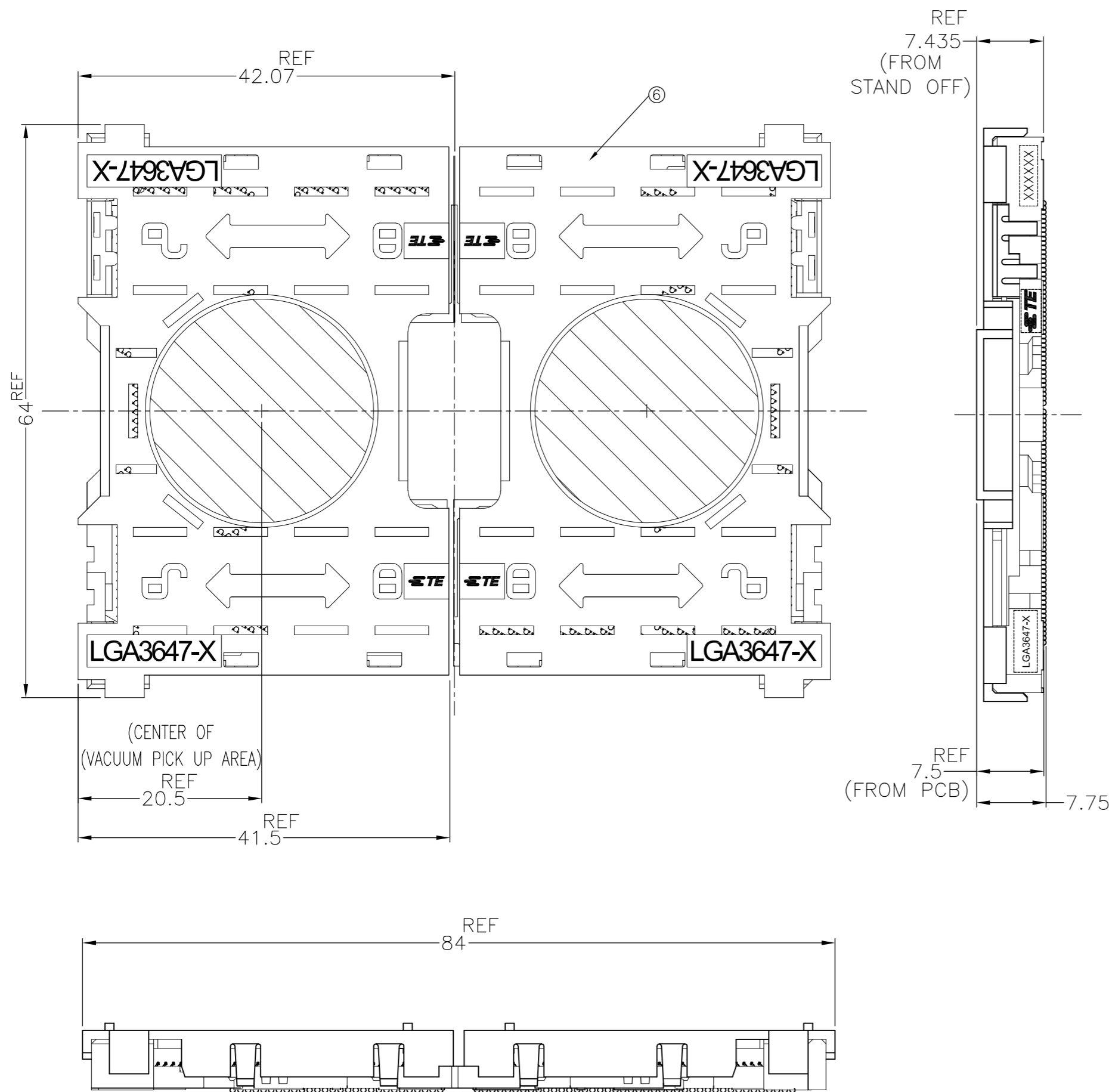

AFTER SMT CONDITION (WITH CAP)
 DEMONSTRATION BY SOCKET P1,LGA3647-1

1. MATERIAL
- ① HOUSING : HIGH TEMP, THERMO-PLASTIC, UL94V-0, BLACK
 - ② CONTACT : COPPER ALLOY
FINISH : Au PL. SHOW AS Δ AT CONTACT AREA
ON OVERALL OVER Ni UNDER PL. 0.00127 MIN.
 - ③ SOLDER BALL : Sn/Ag/Cu
 - ④ KEY HSG LEFT : HIGH TEMP. THERMO-PLASTIC, UL94V-0, BLACK
 - ⑤ KEY HSG RIGHT: HIGH TEMP. THERMO-PLASTIC, UL94V-0, P0 YELLOW, P1 NATURAL
 - ⑥ CAP : HIGH TEMP. THERMO-PLASTIC, UL94V-0, NATURAL
- Δ INDICATED DATE CODE , TYCO LOGO, PRODUCT NAME ON THE HSG
 Δ FOR NORMAL ORDER, LEFT AND RIGHT SEGMENT SHOULD ORDER AT SAME TIME

LGA3647-1 SOCKET P1				LGA3647-0 SOCKET P0				PRODUCT NAME
30u Au PLATING		15u Au PLATING		30u Au PLATING		15u Au PLATING		
LGA3647-1 RIGHT SEGMENT	LGA3647-1 LEFT SEGMENT	LGA3647-1 RIGHT SEGMENT	LGA3647-1 LEFT SEGMENT	LGA3647-0 RIGHT SEGMENT	LGA3647-0 LEFT SEGMENT	LGA3647-0 RIGHT SEGMENT	LGA3647-0 LEFT SEGMENT	ASSY PART NUMBER
2822980-4	1-2822980-4	2822980-2	1-2822980-2	2822980-3	1-2822980-3	2822980-1	1-2822980-1	

14.5	21	17	1						2-2129710-8
		16		1					2-2129710-7
	21	17			1				2-2129710-6
		16				1			2-2129710-5
									2-2129710-4
									2-2129710-3
									2-2129710-2
									2-2129710-1

PRODUCT WEIGHT (g/SOCKET)	DIMENSION D2	DIMENSION D1	QTY.		PACKAGE PART NO.
THIS DRAWING IS A CONTROLLED DOCUMENT.			DWN T.KUO 04MAR2015		
DIMENSIONS: mm			CHK M.CHAO 04MAR2015		
TOLERANCES UNLESS OTHERWISE SPECIFIED:			APVD M.CHAO 04MAR2015	NAME	
0-PLC ± 1-PLC ± ±0.3 2-PLC ± ±3 3-PLC ± ±3 4-PLC ± ± ANGLES ± -			PRODUCT SPEC 108-115115	SOCKET ASSY LGA3647-X	
MATERIAL			APPLICATION SPEC 114-115011	SIZE A2	CAGE CODE 00779
FINISH			WEIGHT -	DRAWING NO C=2129710	RESTRICTED TO -
			CUSTOMER DRAWING	SCALE NTS	SHEET 1 OF 7 REV C

THIS DRAWING IS UNPUBLISHED. RELEASED FOR PUBLICATION
 © COPYRIGHT - Tyco Electronics JAPAN G.K. ALL RIGHTS RESERVED.

LOC		DIST		REVISIONS			
P	LTR	DESCRIPTION	DATE	DWN	APVD		
-	-	SEE SHEET 1	-	-	-		

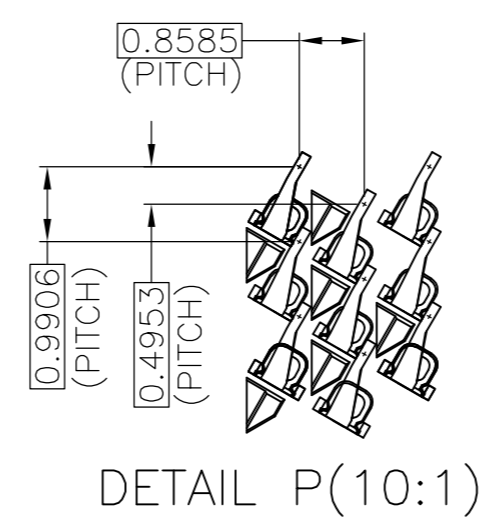
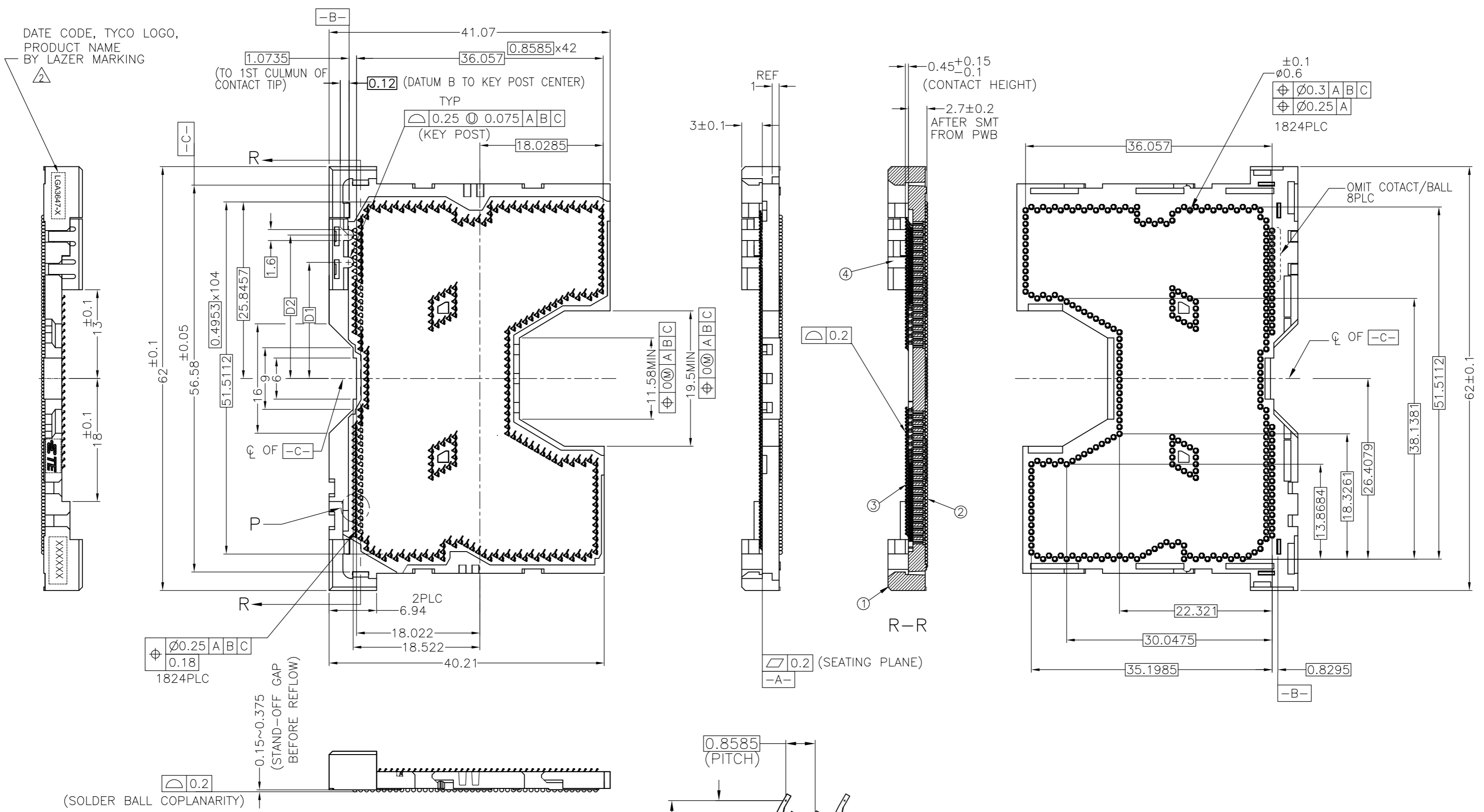

THESE VIEW DON'T SHOW CAP BEFORE SMT CONDITION
 LGA3647-1 LEFT SIDE ASSY
 1-2822980-* AS SHOWN

THIS DRAWING IS A CONTROLLED DOCUMENT.		DWN	-	TE Connectivity	
DIMENSIONS: mm		CHK	-		
TOLERANCES UNLESS OTHERWISE SPECIFIED:		APVD	-	NAME	
0-PLC ± 1-PLC ± ±0.3 2-PLC ± ±3 3-PLC ± ±3 4-PLC ± ± ANGLES ± ± FINISH -		PRODUCT SPEC	-	SOCKET ASSY LGA3647-X	
MATERIAL		APPLICATION SPEC	-	SIZE	A2
		WEIGHT	-	CAGE CODE	00779
		CUSTOMER DRAWING	-	DRAWING NO	C=2129710
		SCALE	NTS	SHEET	2 OF 7
		REV	C	RESTRICTED TO	

LOC		DIST		REVISIONS			
P	LTR	DESCRIPTION	DATE	DWN	APVD		
ES	-	SEE SHEET 1	-	-	-		

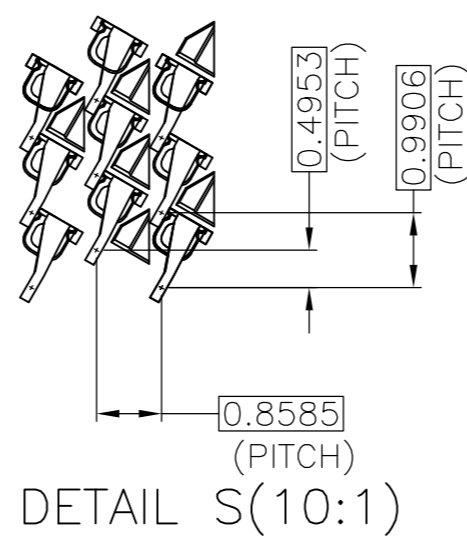
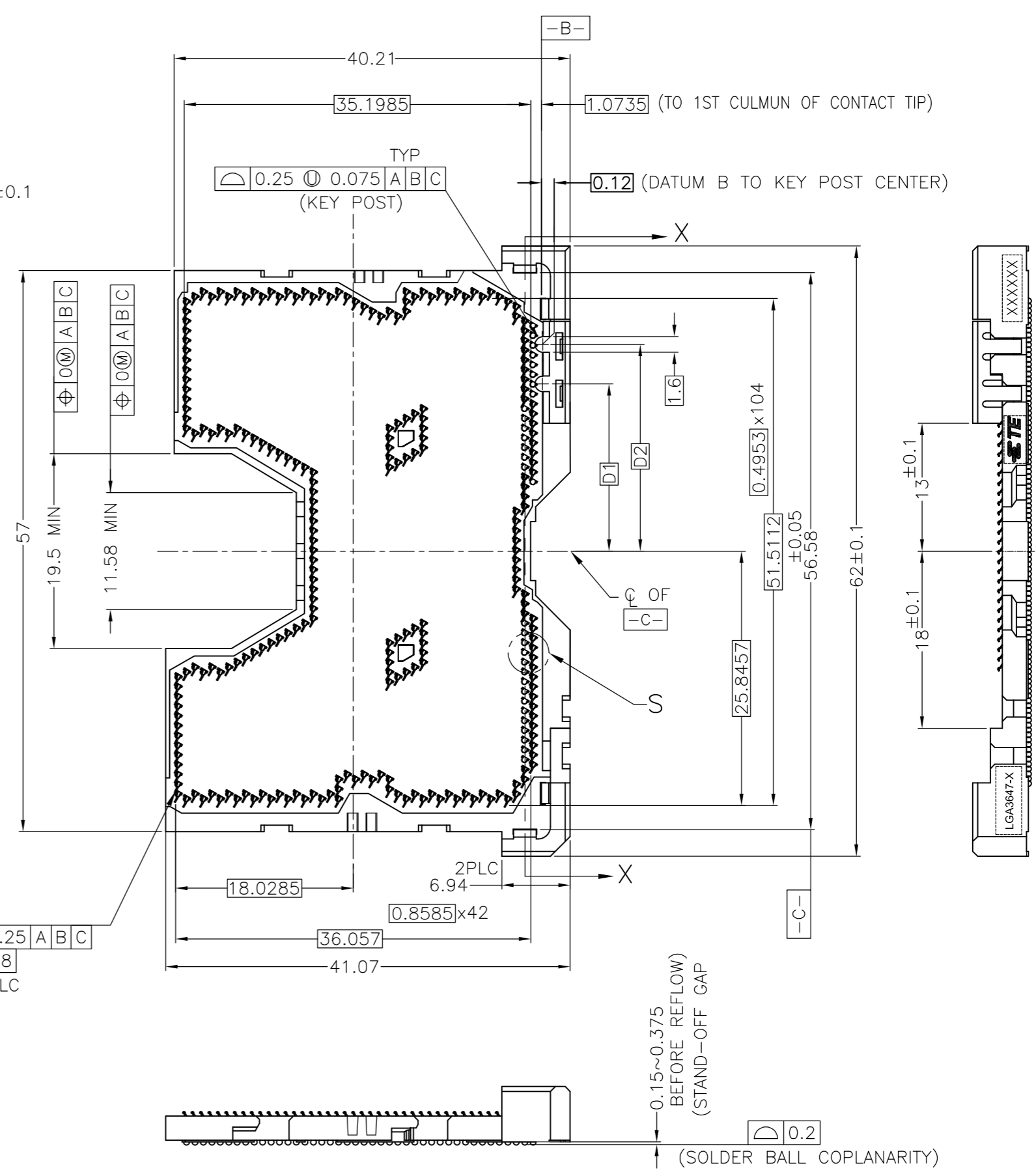
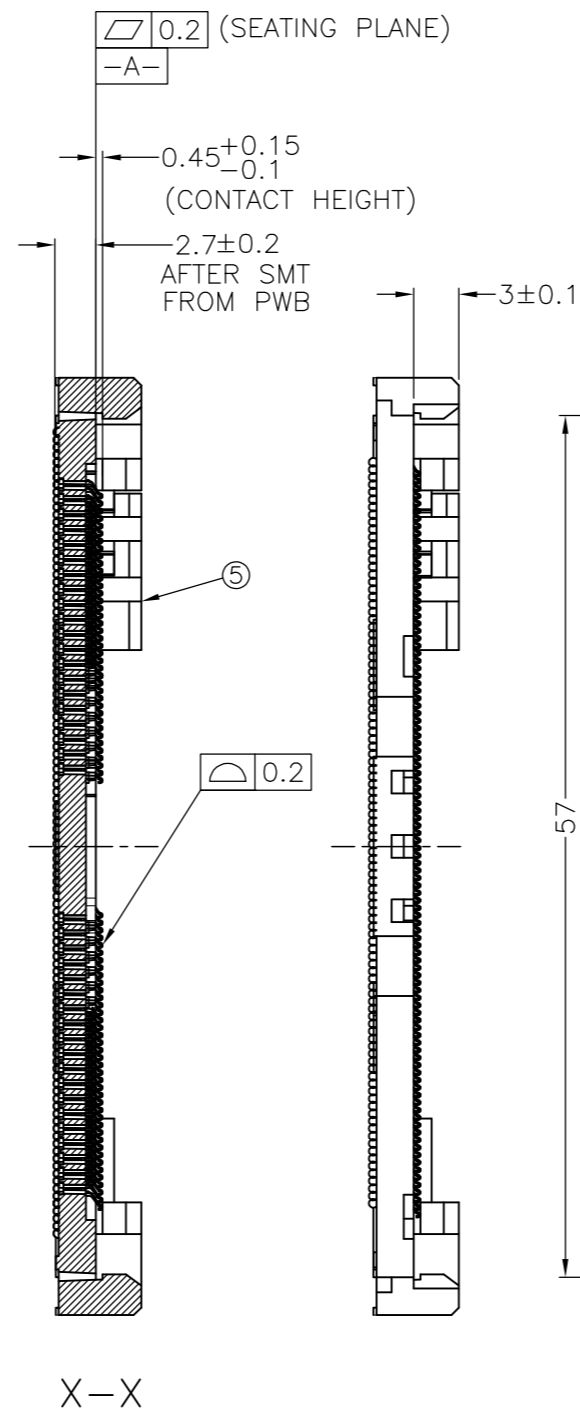
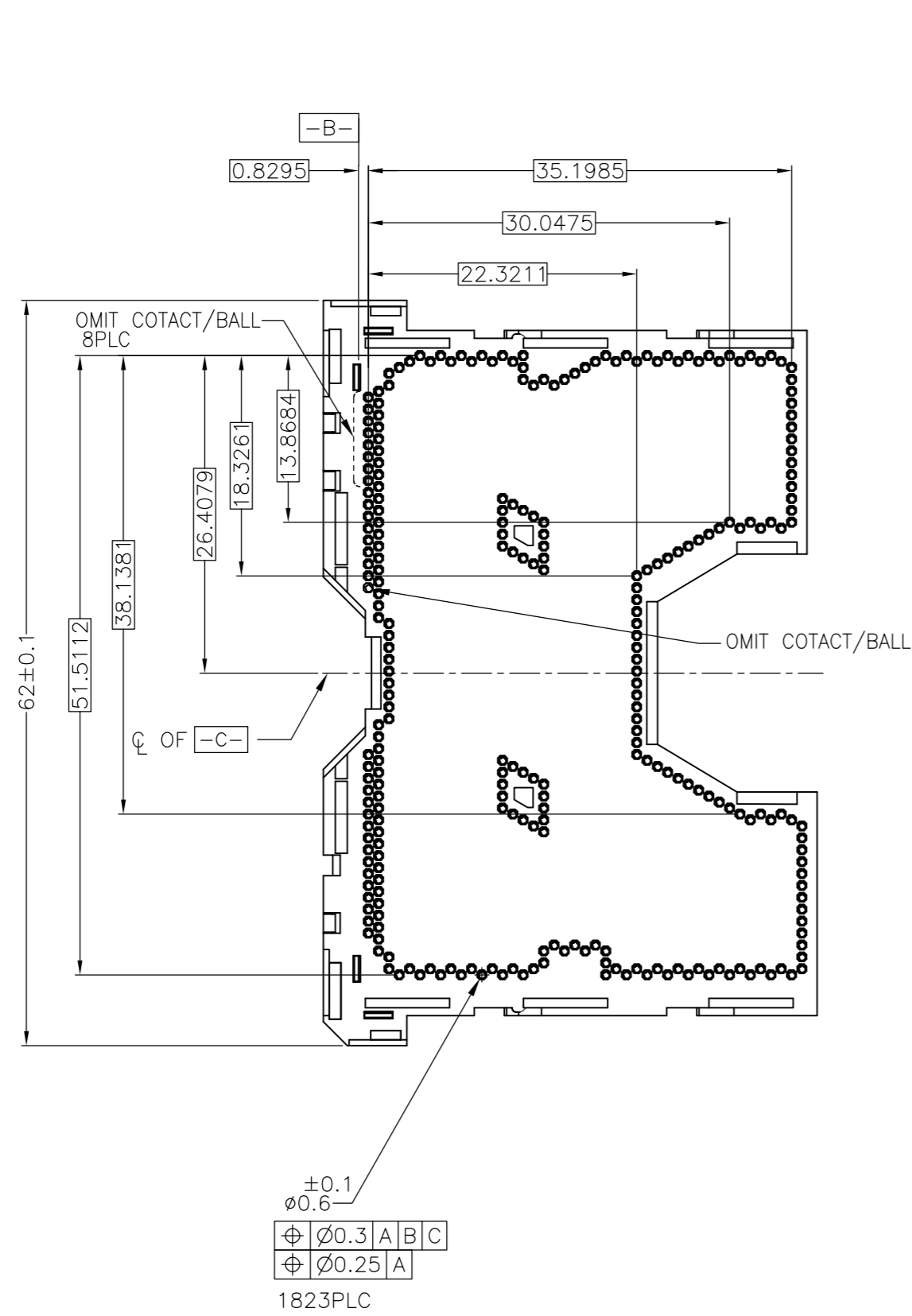

THESE VIEW DON'T SHOW CAP BEFORE SMT CONDITION LGA3647-1 RIGHT SIDE ASSY 2822980-* AS SHOWN

THIS DRAWING IS A CONTROLLED DOCUMENT.		DWN	TE Connectivity	
DIMENSIONS: mm		CHK	NAME	
TOLERANCES UNLESS OTHERWISE SPECIFIED:		APVD	SOCKET ASSY LGA3647-X	
0-PLC ±		PRODUCT SPEC	SIZE	CAGE CODE
1-PLC ± ±0.3		APPLICATION SPEC	A2	00779
2-PLC ± ±3		WEIGHT	DRAWING NO	RESTRICTED TO
3-PLC ±		CUSTOMER DRAWING	C=2129710	-
4-PLC ±		SCALE	NTS	SHEET 3 OF 7
ANGLES ±		REV	C	
FINISH				

THIS DRAWING IS UNPUBLISHED. RELEASED FOR PUBLICATION
 © COPYRIGHT - Tyco Electronics JAPAN G.K. ALL RIGHTS RESERVED.

LOC	DIST	REVISIONS					
		P	LTR	DESCRIPTION	DATE	DWN	APVD
ES	-	-	-	SEE SHEET 1	-	-	-

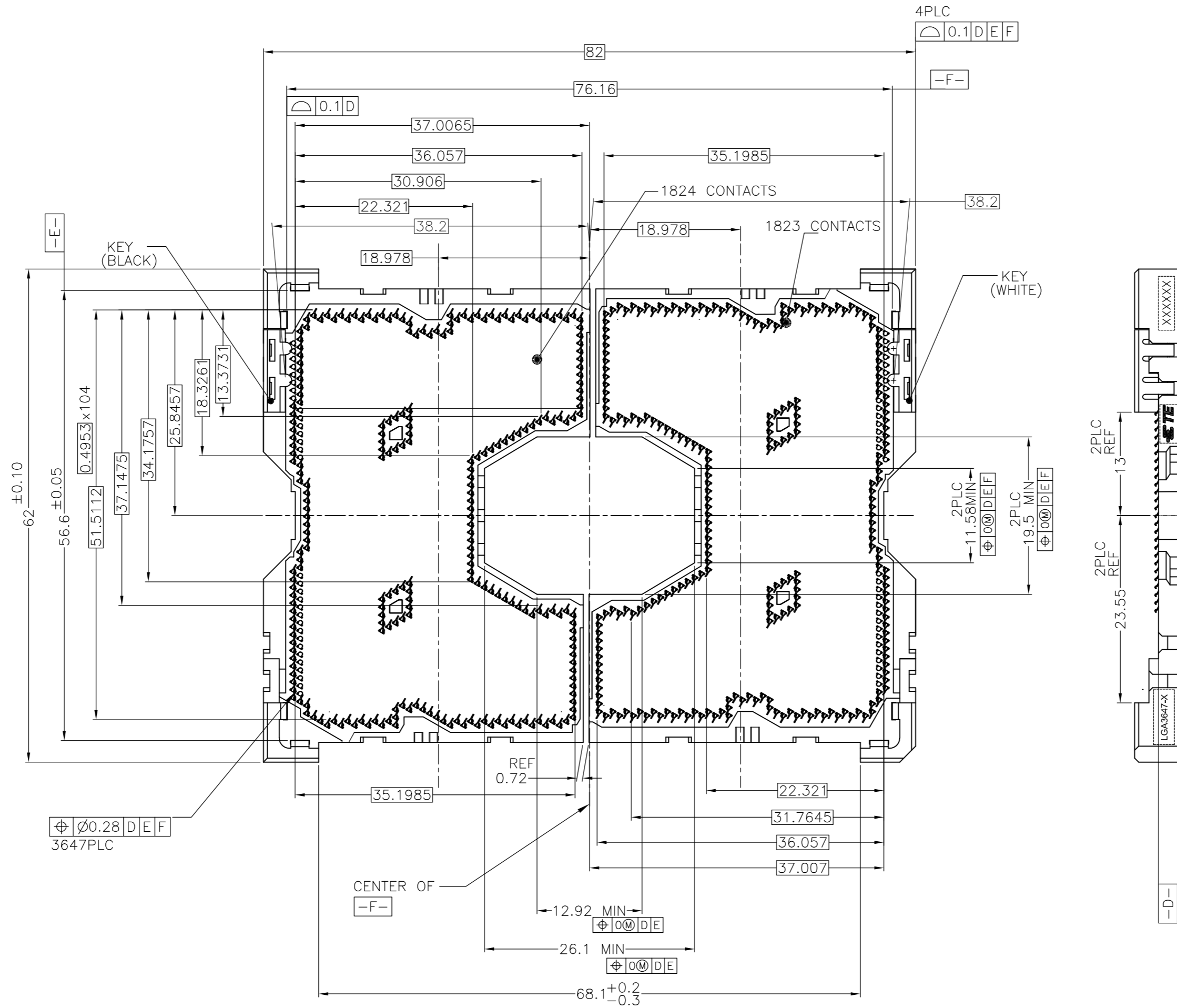

AFTER SMT CONDITION

THIS DRAWING IS A CONTROLLED DOCUMENT.		DWN	-	TE Connectivity	
DIMENSIONS: mm		CHK	-		
TOLERANCES UNLESS OTHERWISE SPECIFIED:		APVD	-	NAME	
0-PLC ± 1-PLC ± 2-PLC ± 3-PLC ± 4-PLC ± ANGLES ±		PRODUCT SPEC APPLICATION SPEC		SOCKET ASSY LGA3647-X	
MATERIAL		WEIGHT		SIZE	RESTRICTED TO
FINISH		-		CAGE CODE	DRAWING NO
-		-		A2 00779	C=2129710
CUSTOMER DRAWING				SCALE	SHEET
-				NTS	4 OF 7
-				REV	C

THIS DRAWING IS UNPUBLISHED. RELEASED FOR PUBLICATION
 © COPYRIGHT - Tyco Electronics JAPAN G.K. ALL RIGHTS RESERVED.

LOC		DIST		REVISIONS			
P	LTR	DESCRIPTION	DATE	DWN	APVD		
-	-	SEE SHEET 1	-	-	-		

D

C

B

A

D

C

B

A

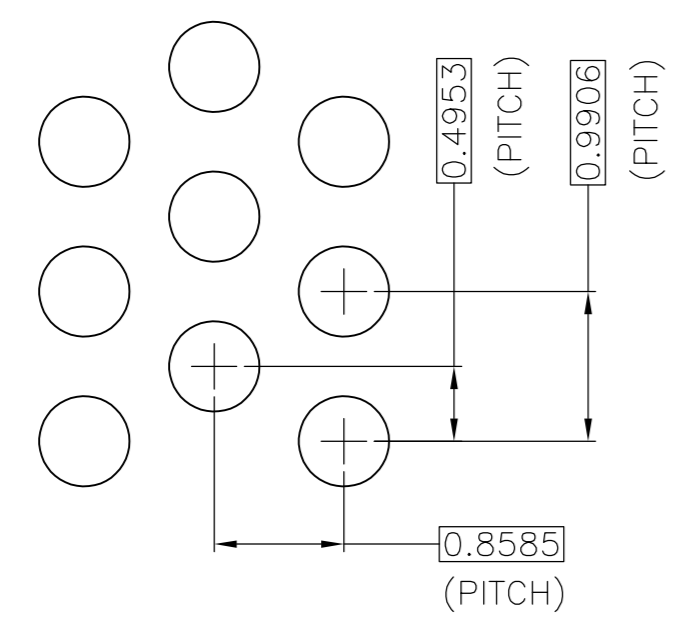
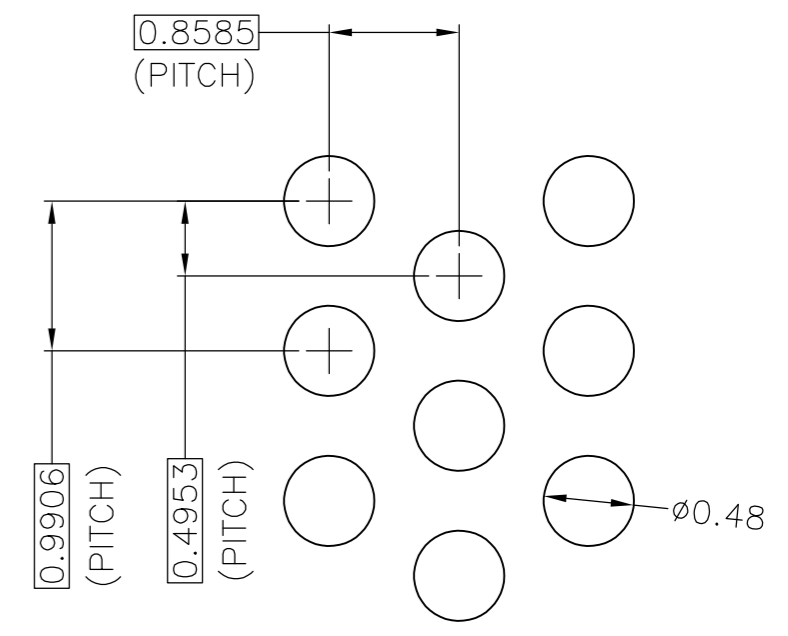
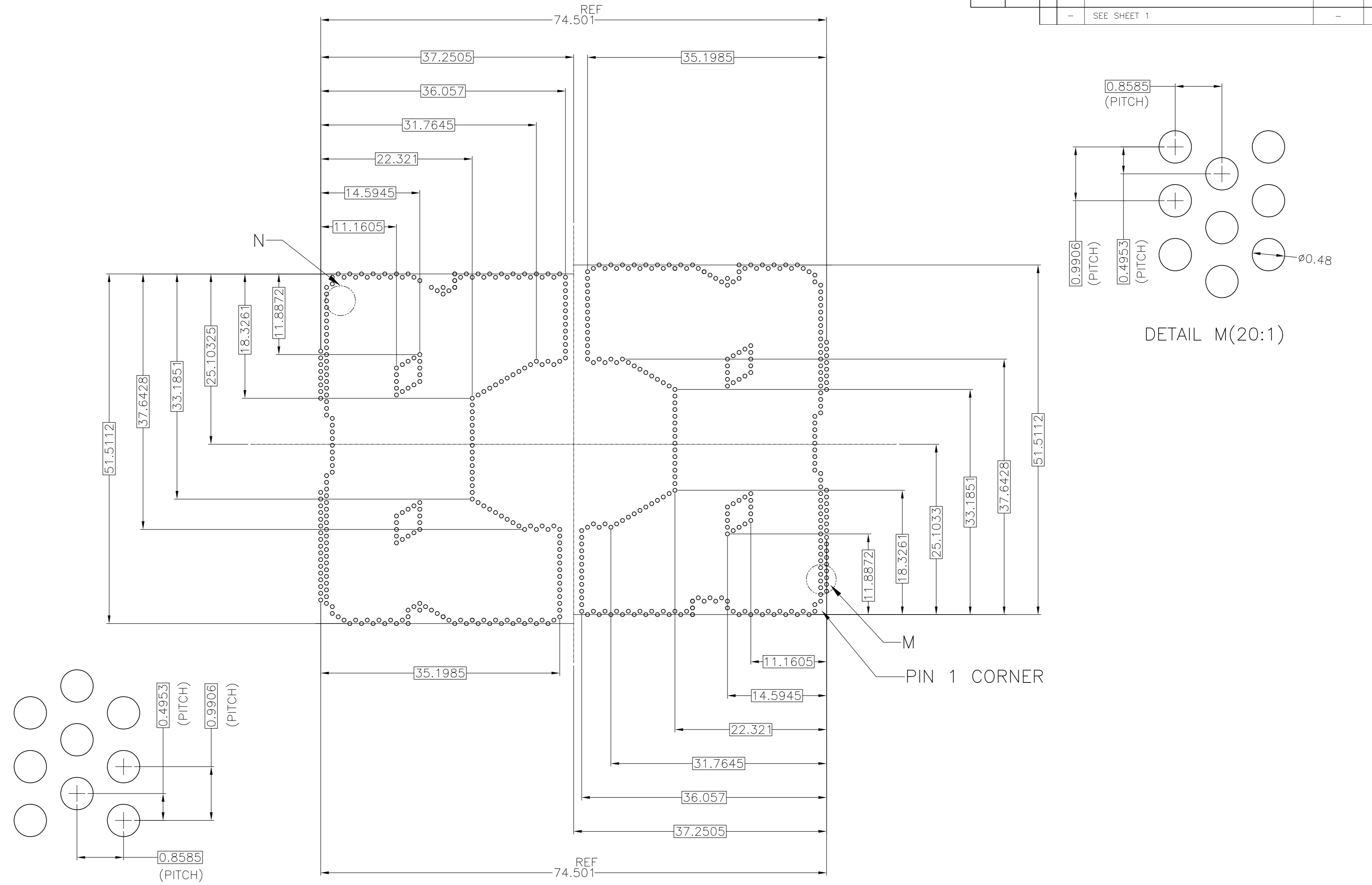

DETAIL N(20:1)

THIS DRAWING IS A CONTROLLED DOCUMENT.		DWN	-		
DIMENSIONS: mm		CHK	-		
TOLERANCES UNLESS OTHERWISE SPECIFIED:		APVD	-		
0-PLC ±		NAME			
1-PLC ± ±0.3		PRODUCT SPEC			
2-PLC ± ±3		APPLICATION SPEC			
3-PLC ±		SIZE	CAGE CODE	DRAWING NO	RESTRICTED TO
4-PLC ±		A2	00779	C=2129710	-
ANGLES ±		CUSTOMER DRAWING			
FINISH		SCALE	SHEET	REV	
		NTS	5 of 7	C	



SOCKET ASSY
LGA3647-X

2129710

THIS DRAWING IS UNPUBLISHED. RELEASED FOR PUBLICATION
 © COPYRIGHT - Tyco Electronics JAPAN G.K. ALL RIGHTS RESERVED.

LOC	DIST	REVISIONS					
		P	LTR	DESCRIPTION	DATE	DWN	APVD
ES	-	-	-	SEE SHEET 1	-	-	-

SOCKET P0,LGA3647-0 AS SHOWN

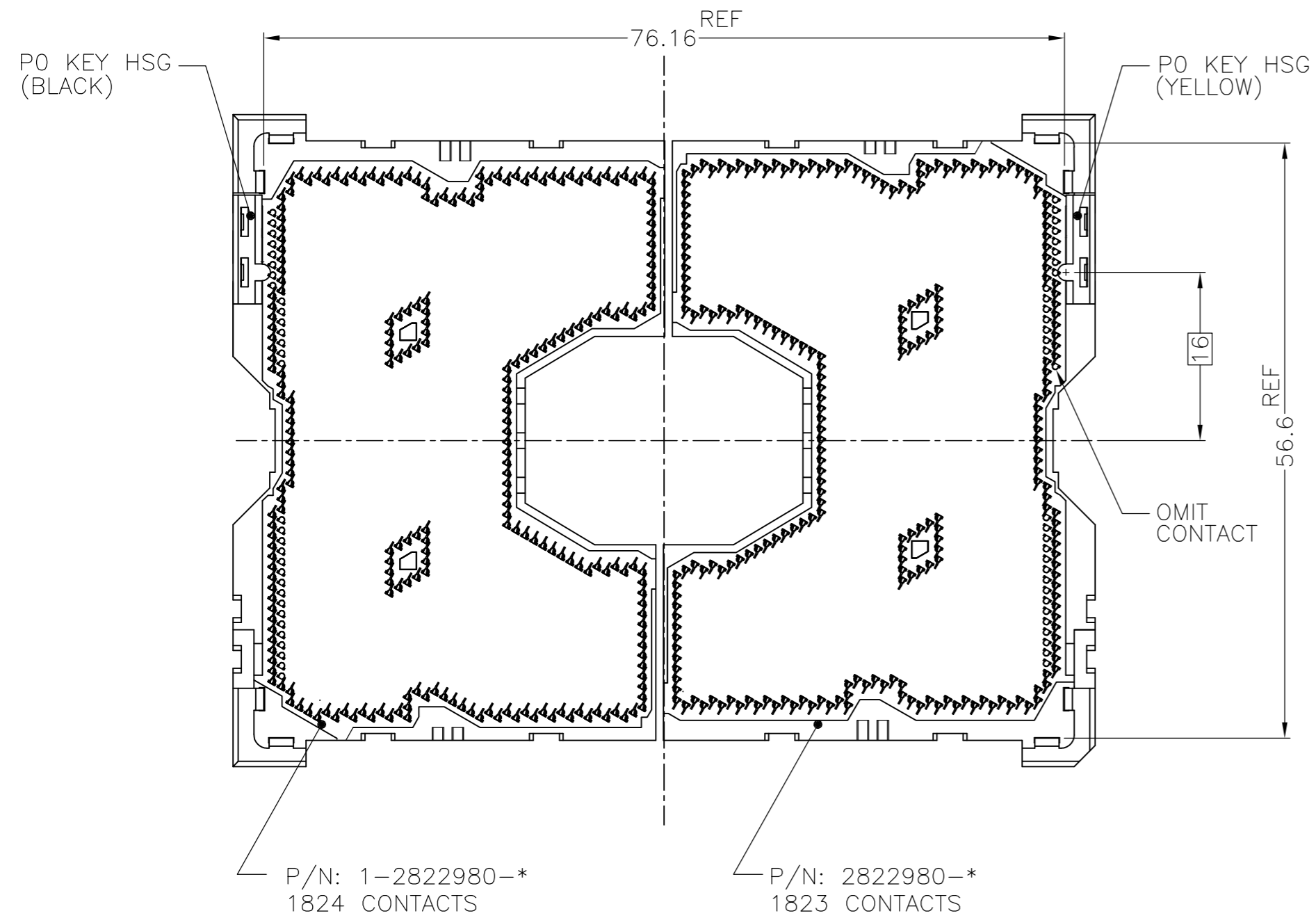

LGA3647-0 AS SHOWN
(KIT P/N: 2-2822979-*)

SOCKET P1,LGA3647-1 AS SHOWN

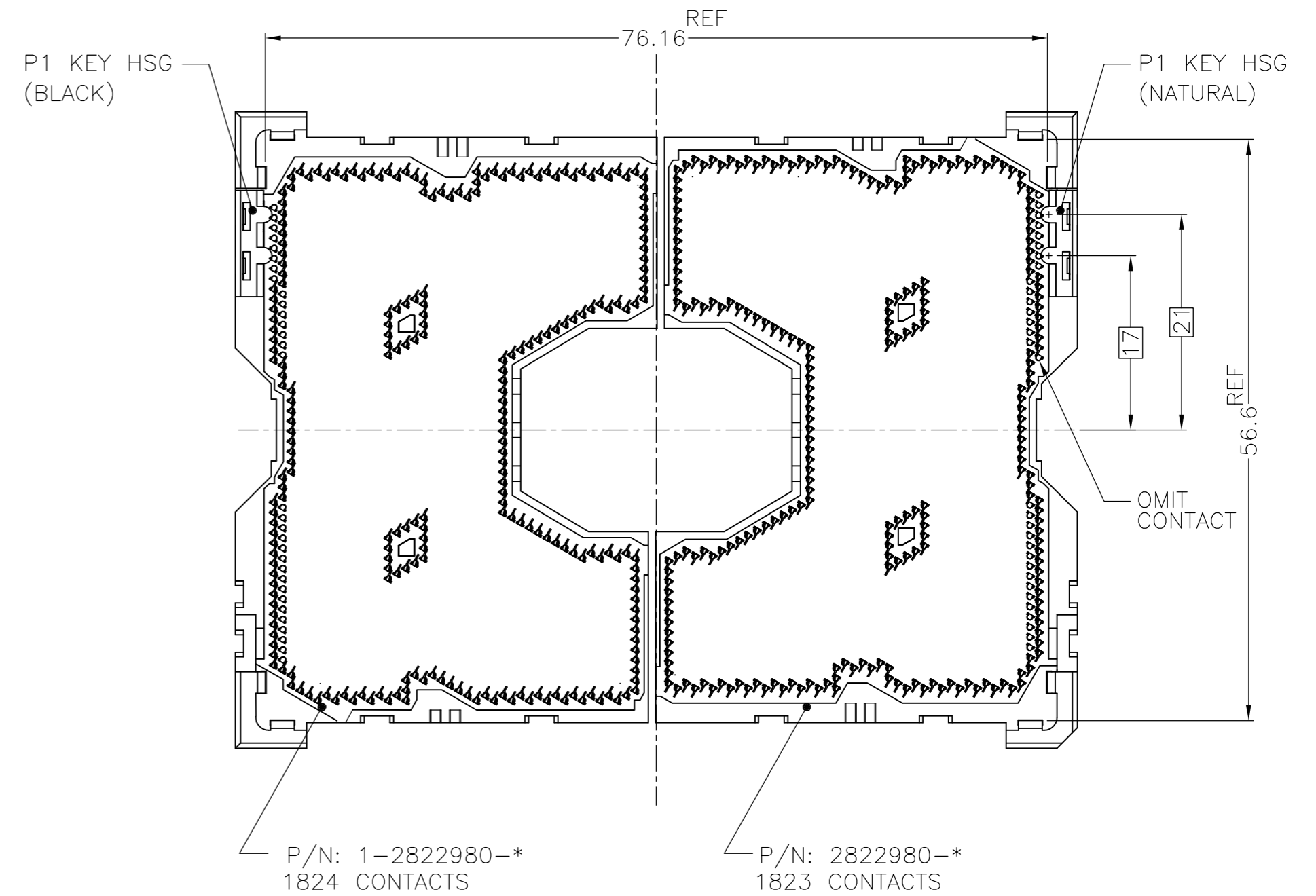

LGA3647-1 AS SHOWN
(KIT P/N: 2-2822979-*)

LGA3647-X POST SMT CONDITION
(PCB IS NOT SHOWN)

THIS DRAWING IS A CONTROLLED DOCUMENT.		DWN	TE Connectivity		
DIMENSIONS: mm		CHK	NAME		
TOLERANCES UNLESS OTHERWISE SPECIFIED:		APVD	SOCKET ASSY LGA3647-X		
0-PLC ± 1-PLC ± ±0.3 2-PLC ± ±3 3-PLC ± ± 4-PLC ± ± ANGLES ± ± FINISH -		PRODUCT SPEC	SIZE	CAGE CODE	DRAWING NO
MATERIAL		APPLICATION SPEC	A2	00779	C=2129710
		WEIGHT	RESTRICTED TO		
		CUSTOMER DRAWING	SCALE	SHEET	REV
			NTS	6 of 7	C

THIS DRAWING IS UNPUBLISHED. RELEASED FOR PUBLICATION
 © COPYRIGHT - Tyco Electronics JAPAN G.K. ALL RIGHTS RESERVED.

LOC	DIST	REVISIONS					
ES	-	P	LTR	DESCRIPTION	DATE	DWN	APVD
		-	-	SEE SHEET 1	-	-	-

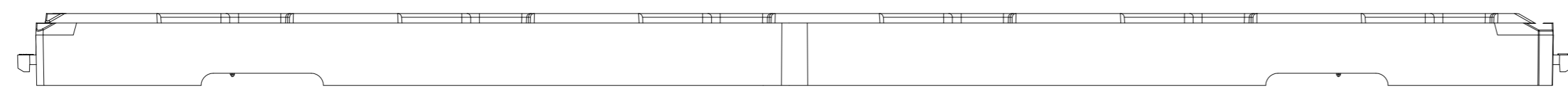
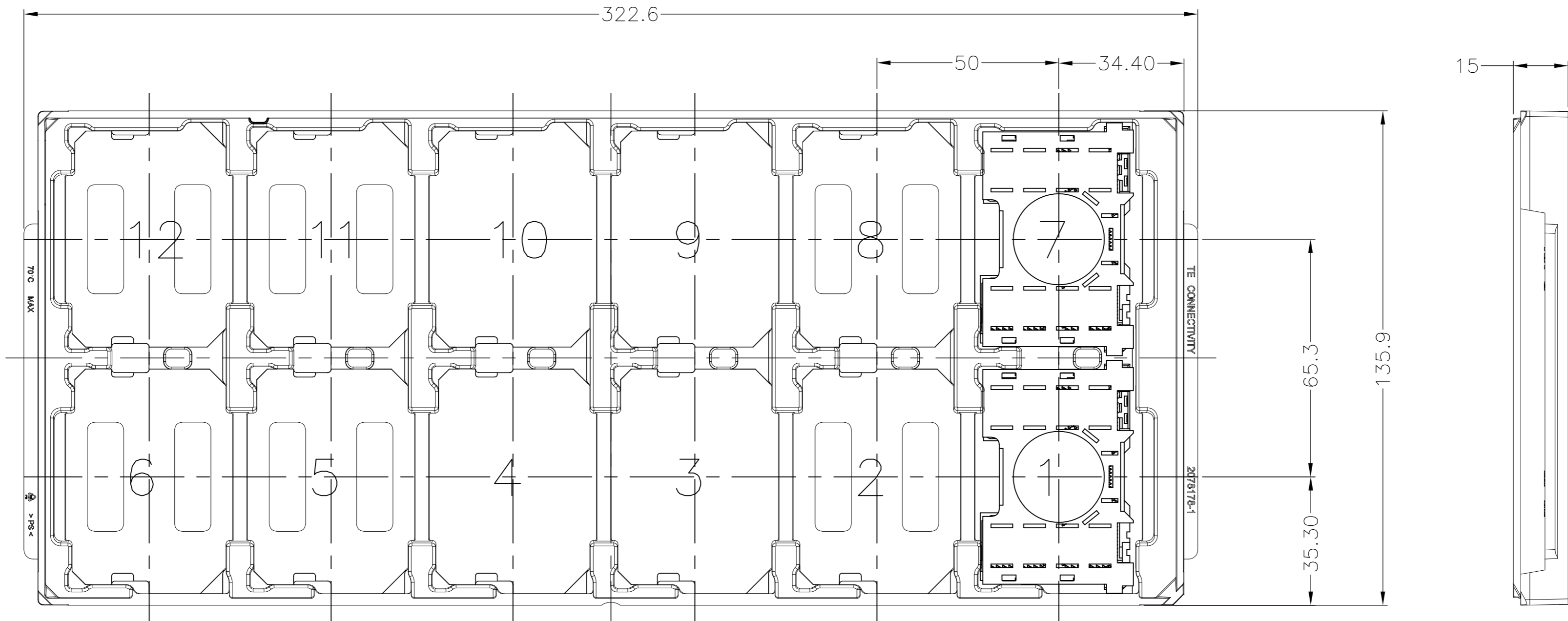

FOR LEFT SEGMENT, USE BLACK TRAY TO PACKAGE.
 FOR RIGHT SEGMENT, USE BLUE TRAY TO PACKAGE.

168	84	12	2822980-4	2-2129710-8	LGA3647-1 RIGHT SEGMENT	LGA3647-1 SOCKET P1
168	84	12	1-2822980-4	2-2129710-7	LGA3647-1 LFFT SEGMENT	LGA3647-1 SOCKET P0
168	84	12	2822980-3	2-2129710-6	LGA3647-0 RIGHT SEGMENT	LGA3647-0 SOCKET P1
168	84	12	1-2822980-3	2-2129710-5	LGA3647-0 LFFT SEGMENT	LGA3647-0 SOCKET P0
168	84	12	2822980-2	2-2129710-4	LGA3647-1 RIGHT SEGMENT	LGA3647-1 SOCKET P1
168	84	12	1-2822980-2	2-2129710-3	LGA3647-1 LFFT SEGMENT	LGA3647-1 SOCKET P0
168	84	12	2822980-1	2-2129710-2	LGA3647-0 RIGHT SEGMENT	LGA3647-0 SOCKET P1
168	84	12	1-2822980-1	2-2129710-1	LGA3647-0 LFFT SEGMENT	LGA3647-0 SOCKET P0
SOCKET QTY PER OUTER BOX	SOCKET QTY PER INNER BOX	SOCKET QTY PER TRAY	ASSY PART NUMBER	ORDER PART NUMBER	PRODUCT NAME	

THIS DRAWING IS A CONTROLLED DOCUMENT.

DWN	-	 TE Connectivity SOCKET ASSY LGA3647-X
CHK	-	
APVD	-	
NAME	-	
DIMENSIONS: mm		PRODUCT SPEC
TOLERANCES UNLESS OTHERWISE SPECIFIED:		APPLICATION SPEC
0-PLC	±	WEIGHT
1-PLC	±0.5	SCALE
2-PLC	±	CAGE CODE
3-PLC	±3	DRAWING NO
4-PLC	±	RESTRICTED TO
ANGLES	±	SIZE
FINISH	-	00779
MATERIAL	-	C=2129710
CUSTOMER DRAWING		SCALE NTS
		SHEET 7 of 7
		REV C