

REVISIONS

P	LTR	DESCRIPTION	DATE	DWN	APVD
	A	NEW RELEASE	30MAY2019	SR	AP

FOR FURTHER INFORMATION SEE DATA SHEET FOR
SMD HIGH POWER PRECISION RESISTORS TYPE RP73 SERIES

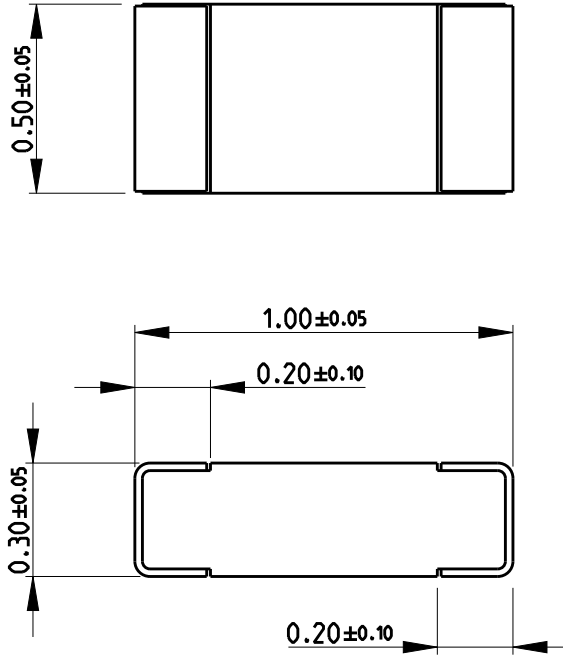

RoHS Compliant

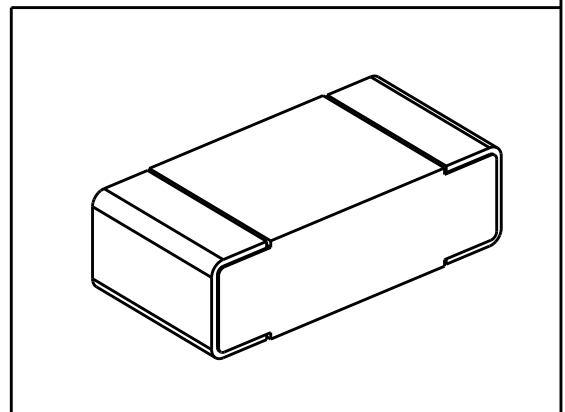

2008

RELEASED FOR PUBLICATION

ALL RIGHTS RESERVED.

BY -

© COPYRIGHT 2008

THIS DRAWING IS UNPUBLISHED.

DIMENSIONS:

mm

TOLERANCES UNLESS OTHERWISE SPECIFIED:

0 PLC	± 0.2
1 PLC	± 0.1
2 PLC	\pm
3 PLC	\pm
4 PLC	\pm
ANGLES	$\pm 5^\circ$



DWN	SUPREETH R	30MAY2019
CHK	A. PILE	30MAY2019
APVD	A. PILE	30MAY2019
PRODUCT SPEC	-	
APPLICATION SPEC	-	
WEIGHT	-	

MATERIAL	-	FINISH	-
 TE Connectivity			
NAME THIN FILM HIGH POWER PRECISION CHIP RESISTOR SERIES RP73 0402			
SIZE	CAGE CODE	DRAWING NO	RESTRICTED TO
A 4	00779	C-2176307	-

CUSTOMER DRAWING	SCALE	NTS	SHEET	1 OF 1	REV	A
------------------	-------	-----	-------	--------	-----	---