

P	LTR	DESCRIPTION	DATE	DWN	APVD
	A	NEW DRAWING	21MAY2018	GCM	AP
	A1	PCB LAYOUT AND SCHEDULE ADDED	24JAN2023	DM	AP
	A2	NEW PN 4-2176340-5 ADDED TO SCHEDULE	10OCT2023	DM	AP

RECOMMENDED PCB LAYOUT PLAN

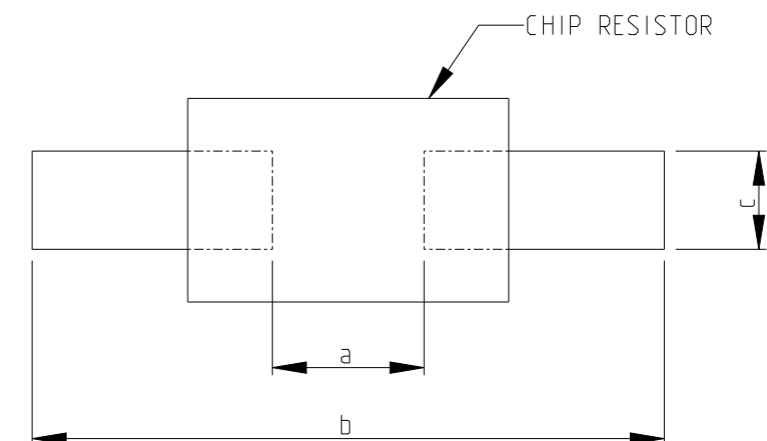

TYPE	a (mm)	b (mm)	c (mm)
0603	0.85 to 0.95	2.05 to 2.15	0.75 to 0.85

RoHS Compliant

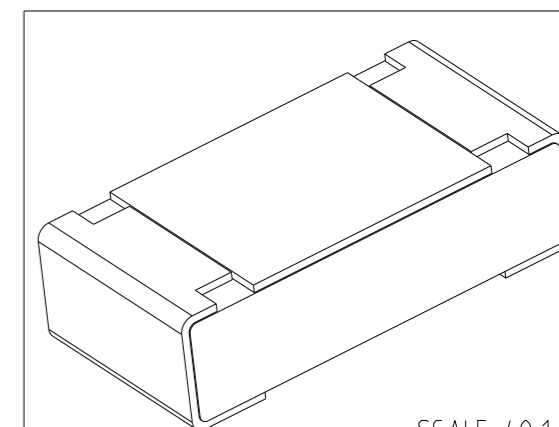

SCALE 40:1

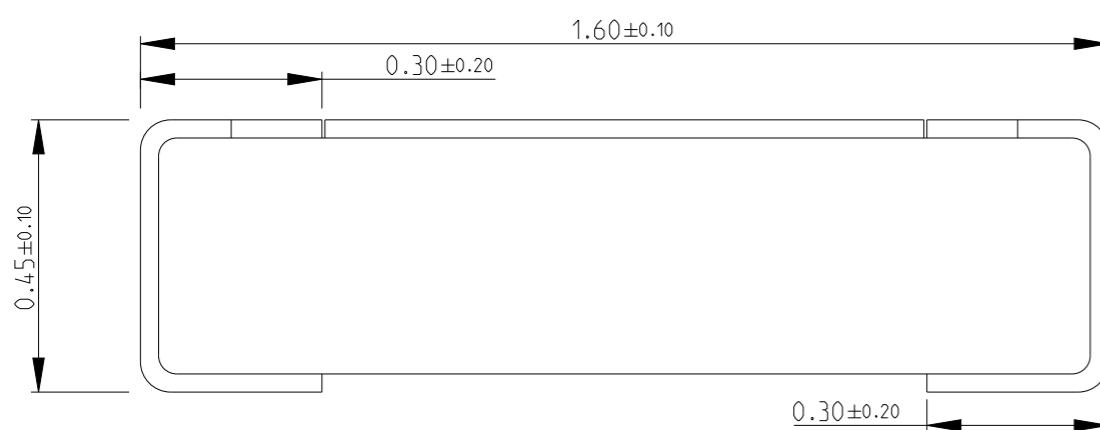
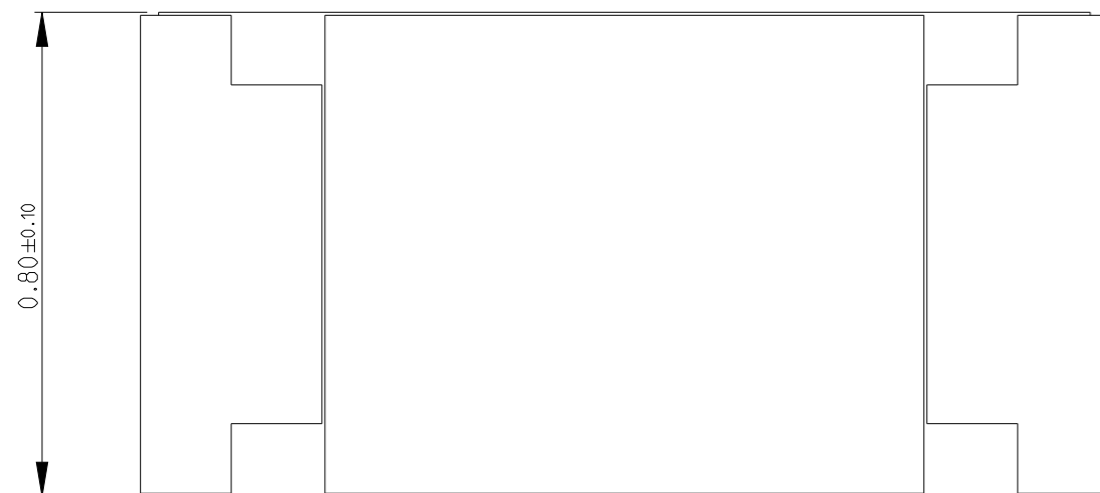

NOTES:

- FOR FURTHER INFORMATION SEE DATA SHEET FOR CRGCQ SERIES SMD AEC-Q200 THICK FILM CHIP RESISTORS

THIS DRAWING IS A CONTROLLED DOCUMENT.		DWN	21MAY2018		
		CHK	21MAY2018		
		APVD	21MAY2018		
DIMENSIONS: mm		TOLERANCES UNLESS OTHERWISE SPECIFIED:		NAME SMD AEC-Q200 COMPLIANT THICK FILM CHIP RESISTOR TYPE CRGCQ 0603 SERIES	
		0 PLC ±0.5		SIZE	
		1 PLC ±0.2		CAGE CODE	
		2 PLC ±0.1		DRAWING NO	
		3 PLC ±		RESTRICTED TO	
		4 PLC ±		-	
		ANGLES ± 5°		-	
MATERIAL		FINISH		WEIGHT	
-		-		-	
CUSTOMER DRAWING				SCALE	80:1
				SHEET	1 OF 3
				REV	A2

REVISIONS

P	LTR	DESCRIPTION	DATE	DWN	APVD
-		SEE SHEET 1	-	-	-

SCHEDULE

TCPN	CATALOGUE NUMBER	PART DESCRIPTION	PART STATUS
2176340-1	CRGCQ0603J1R0	CRGCQ 0603 1R0 5%	PRODUCTION
2176340-2	CRGCQ0603J1R5	CRGCQ 0603 1R5 5%	PRODUCTION
2176340-3	CRGCQ0603J2R2	CRGCQ 0603 2R2 5%	PRODUCTION
2176340-4	CRGCQ0603J3R3	CRGCQ 0603 3R3 5%	PRODUCTION
2176340-5	CRGCQ0603J4R7	CRGCQ 0603 4R7 5%	PRODUCTION
2176340-6	CRGCQ0603J6R8	CRGCQ 0603 6R8 5%	PRODUCTION
2176340-7	CRGCQ0603J10R	CRGCQ 0603 10R 5%	PRODUCTION
2176340-8	CRGCQ0603J15R	CRGCQ 0603 15R 5%	PRODUCTION
2176340-9	CRGCQ0603J22R	CRGCQ 0603 22R 5%	PRODUCTION
1-2176340-0	CRGCQ0603J33R	CRGCQ 0603 33R 5%	PRODUCTION
1-2176340-1	CRGCQ0603J47R	CRGCQ 0603 47R 5%	PRODUCTION
1-2176340-2	CRGCQ0603J68R	CRGCQ 0603 68R 5%	PRODUCTION
1-2176340-3	CRGCQ0603J100R	CRGCQ 0603 100R 5%	PRODUCTION
1-2176340-4	CRGCQ0603J150R	CRGCQ 0603 150R 5%	PRODUCTION
1-2176340-5	CRGCQ0603J220R	CRGCQ 0603 220R 5%	PRODUCTION
1-2176340-6	CRGCQ0603J330R	CRGCQ 0603 330R 5%	PRODUCTION
1-2176340-7	CRGCQ0603J470R	CRGCQ 0603 470R 5%	PRODUCTION
1-2176340-8	CRGCQ0603J680R	CRGCQ 0603 680R 5%	PRODUCTION
1-2176340-9	CRGCQ0603J1K0	CRGCQ 0603 1K0 5%	PRODUCTION
2-2176340-0	CRGCQ0603J1K5	CRGCQ 0603 1K5 5%	PRODUCTION
2-2176340-1	CRGCQ0603J2K2	CRGCQ 0603 2K2 5%	PRODUCTION
2-2176340-2	CRGCQ0603J3K3	CRGCQ 0603 3K3 5%	PRODUCTION
2-2176340-3	CRGCQ0603J4K7	CRGCQ 0603 4K7 5%	PRODUCTION
2-2176340-4	CRGCQ0603J6K8	CRGCQ 0603 6K8 5%	PRODUCTION
2-2176340-5	CRGCQ0603J10K	CRGCQ 0603 10K 5%	PRODUCTION
2-2176340-6	CRGCQ0603J15K	CRGCQ 0603 15K 5%	PRODUCTION
2-2176340-7	CRGCQ0603J22K	CRGCQ 0603 22K 5%	PRODUCTION
2-2176340-8	CRGCQ0603J33K	CRGCQ 0603 33K 5%	PRODUCTION
2-2176340-9	CRGCQ0603J47K	CRGCQ 0603 47K 5%	PRODUCTION
3-2176340-0	CRGCQ0603J68K	CRGCQ 0603 68K 5%	PRODUCTION

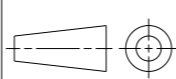
THIS DRAWING IS A CONTROLLED DOCUMENT.		DWN GANESH C M 21MAY2018	 TE Connectivity		
DIMENSIONS: mm		CHK ALLAN.P 21MAY2018			
TOLERANCES UNLESS OTHERWISE SPECIFIED:		APVD ALLAN.P 21MAY2018	NAME SMD AEC-Q200 COMPLIANT THICK FILM CHIP RESISTOR TYPE CRGCQ 0603 SERIES		
		PRODUCT SPEC -	RESTRICTED TO -		
0 PLC ±0.5 1 PLC ±0.2 2 PLC ±0.1 3 PLC ± 4 PLC ± ANGLES ±5°		APPLICATION SPEC -	SIZE A3	CAGE CODE 00779	DRAWING NO C=2176340
MATERIAL -		FINISH -	WEIGHT -	SCALE 80:1	
CUSTOMER DRAWING			SHEET 2 OF 3	REV A2	

REVISIONS

P	LTR	DESCRIPTION	DATE	DWN	APVD
-		SEE SHEET 1	-	-	-

SCHEDULE

TCPN	CATALOGUE NUMBER	PART DESCRIPTION	PART STATUS	NOTE
3-2176340-1	CRGCQ0603J100K	CRGCQ 0603 100K 5%	PRODUCTION	
3-2176340-2	CRGCQ0603J150K	CRGCQ 0603 150K 5%	PRODUCTION	
3-2176340-3	CRGCQ0603J220K	CRGCQ 0603 220K 5%	PRODUCTION	
3-2176340-4	CRGCQ0603J330K	CRGCQ 0603 330K 5%	PRODUCTION	
3-2176340-5	CRGCQ0603J470K	CRGCQ 0603 470K 5%	PRODUCTION	
3-2176340-6	CRGCQ0603J680K	CRGCQ 0603 680K 5%	PRODUCTION	
3-2176340-7	CRGCQ0603J1M0	CRGCQ 0603 1M0 5%	PRODUCTION	
3-2176340-8	CRGCQ0603J1M5	CRGCQ 0603 1M5 5%	PRODUCTION	
3-2176340-9	CRGCQ0603J2M2	CRGCQ 0603 2M2 5%	PRODUCTION	
4-2176340-0	CRGCQ0603J3M3	CRGCQ 0603 3M3 5%	PRODUCTION	
4-2176340-1	CRGCQ0603J4M7	CRGCQ 0603 4M7 5%	PRODUCTION	
4-2176340-2	CRGCQ0603J6M8	CRGCQ 0603 6M8 5%	PRODUCTION	
4-2176340-3	CRGCQ0603J10M	CRGCQ 0603 10M 5%	PRODUCTION	
4-2176340-4	CRGCQ0603ZR	CRGCQ 0603 ZEROHM	PRODUCTION	
4-2176340-5	CRGCQ0603F4K7V	CRGCQ 0603 4K7 1% 100K MOQ	PRODUCTION	SAME AS PN 3-2176339-3 ON 20K REELS

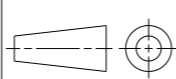
THIS DRAWING IS A CONTROLLED DOCUMENT.		DWN GANESH C M 21MAY2018	 TE Connectivity	
DIMENSIONS: mm		CHK ALLAN.P 21MAY2018		
		APVD ALLAN.P 21MAY2018	NAME SMD AEC-Q200 COMPLIANT THICK FILM CHIP RESISTOR TYPE CRGCQ 0603 SERIES	
TOLERANCES UNLESS OTHERWISE SPECIFIED:		PRODUCT SPEC	RESTRICTED TO	
0 PLC ±0.5		APPLICATION SPEC	SIZE	CAGE CODE
1 PLC ±0.2			A3	00779
2 PLC ±0.1			DRAWING NO	©=2176340
3 PLC ±-				
4 PLC ±-				
ANGLES ±5°		WEIGHT		
FINISH				
MATERIAL				
CUSTOMER DRAWING			SCALE	SHEET
			80:1	3 OF 3
			REV A2	