

REVISIONS					
P	LTR	DESCRIPTION	DATE	DWN	APVD
	A	NEW DRAWING	21MAY2018	GCM	AP
	B	ECR-20-007404	28MAY2020	SR	AP

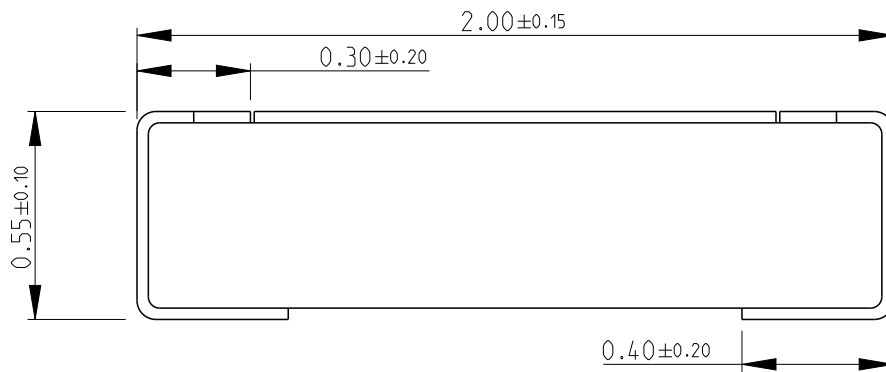
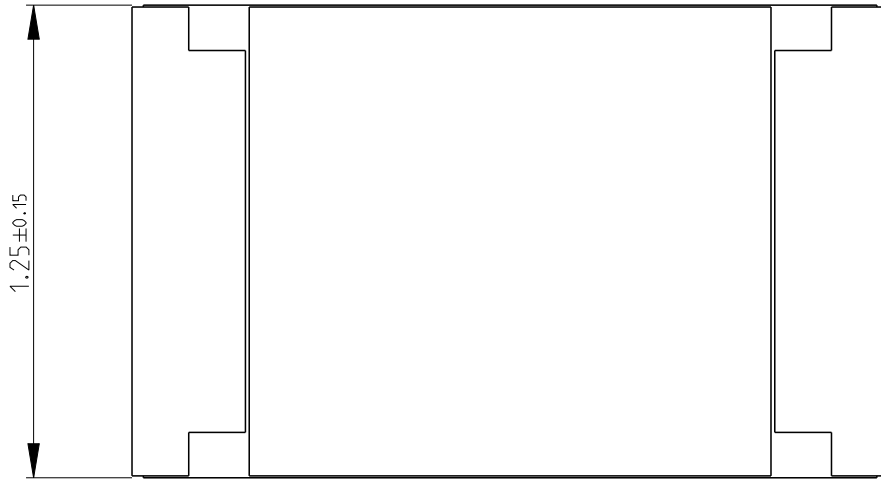

NOTES:

- FOR FURTHER INFORMATION SEE DATA SHEET FOR RQ73 SERIES AEC-Q200 THIN FILM PRECISION RESISTORS.

RoHS Compliant

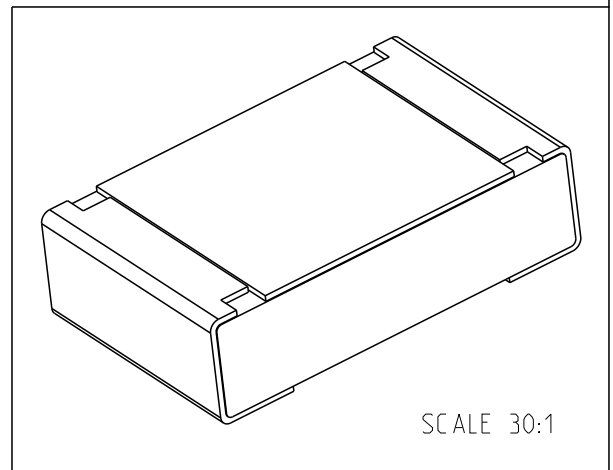

© 2020 TE Connectivity. All Rights Reserved.

DIMENSIONS: mm		DWN GANESH C M	21MAY2018	MATERIAL	-	FINISH	-
TOLERANCES UNLESS OTHERWISE SPECIFIED:		CHK ALLAN.P	21MAY2018	 TE Connectivity			
		APVD ALLAN.P	21MAY2018				
0 PLC ±0.5 1 PLC ±0.2 2 PLC ±0.1 3 PLC ± 4 PLC ± ANGLES ±5°		PRODUCT SPEC		NAME SMD Thin Film Precision Resistors - AEC-Q200 Compliant - Type RQ73 0805 Series			
		APPLICATION SPEC		SIZE	CAGE CODE	DRAWING NO	RESTRICTED TO
		WEIGHT		A 4	00779	C=2176379	
CUSTOMER DRAWING				SCALE	50:1	SHEET	1 OF 2
						REV	B

REVISIONS					
P	LTR	DESCRIPTION	DATE	DWN	APVD
	-	SEE SHEET 1	-	-	-

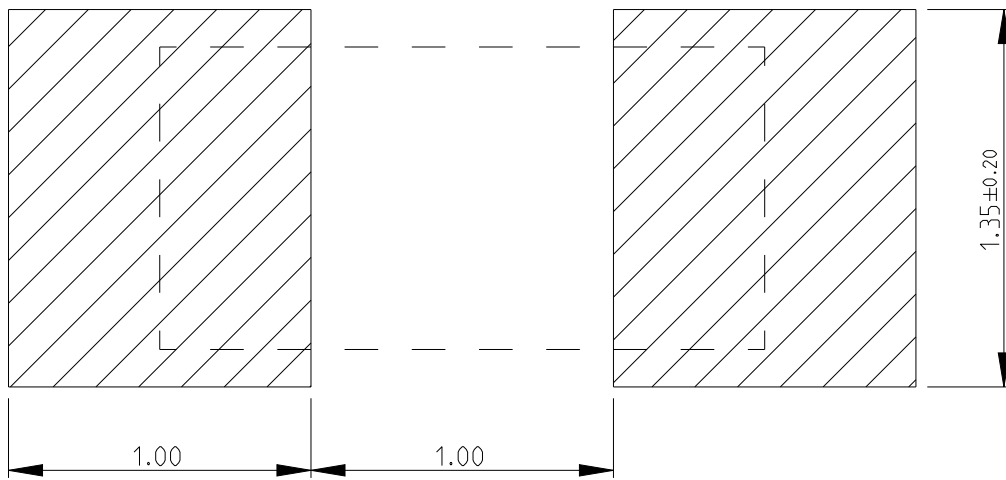

RECOMMENDED LAND PATTERN

© 2020 TE Connectivity. All Rights Reserved.

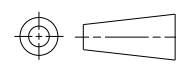
DIMENSIONS: mm		DWN GANESH C M 21MAY2018	MATERIAL -	FINISH -		
TOLERANCES UNLESS OTHERWISE SPECIFIED: 0 PLC ±0.5 1 PLC ±0.2 2 PLC ±0.1 3 PLC ± 4 PLC ± ANGLES ±5°		CHK ALLAN.P 21MAY2018				
		APVD ALLAN.P 21MAY2018				
		PRODUCT SPEC -	NAME SMD Thin Film Precision Resistors - AEC-Q200 Compliant - Type RQ73 0805 Series			
		APPLICATION SPEC -	SIZE A 4	CAGE CODE 00779	DRAWING NO C=2176379	RESTRICTED TO
WEIGHT -		CUSTOMER DRAWING		SCALE NTS	SHEET 2 OF 2	REV B