

REVISIONS

P	LTR	DESCRIPTION	DATE	DWN	APVD
	A	NEW DRAWING	21MAY2018	GCM	AP
	B	ECR-20-007406	28MAY2020	SR	AP
	C	REVISED PER ECR-23-188753	30AUG2024	DM	TG

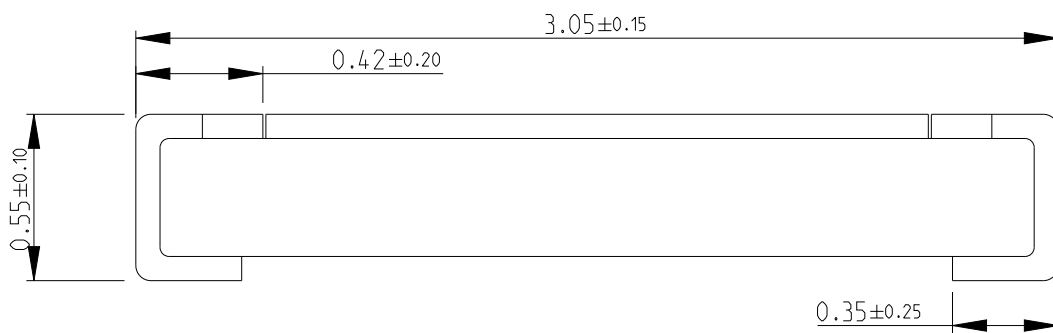
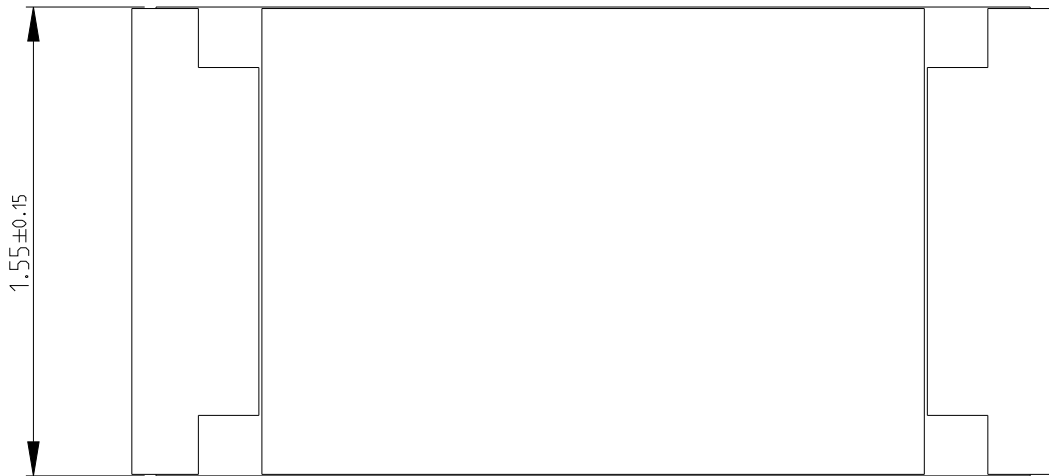

NOTES:

- FOR FURTHER INFORMATION SEE DATA SHEET FOR RQ73 SERIES AEC-Q200 THIN FILM PRECISION RESISTORS.

RoHS Compliant

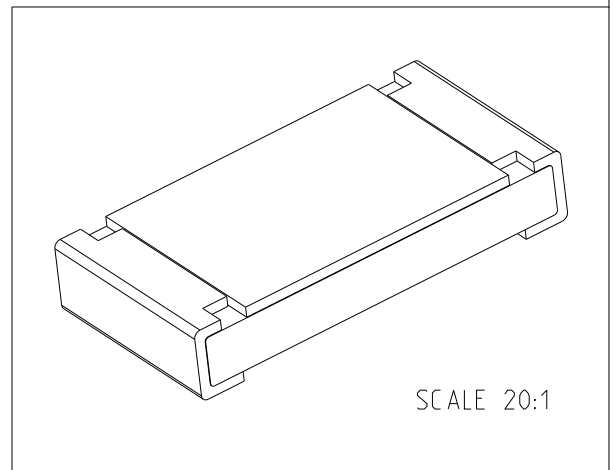

© 2020 TE Connectivity. All Rights Reserved.

DIMENSIONS: mm	DWN GANESH C M	21MAY2018	MATERIAL	-	FINISH	-
	CHK ALLAN.P	21MAY2018				
TOLERANCES UNLESS OTHERWISE SPECIFIED:	APVD ALLAN.P	21MAY2018				
	0 PLC ±0.5	PRODUCT SPEC	NAME SMD Thin Film Precision Resistors - AEC-Q200 Compliant - Type RQ73 1206 Series			
1 PLC ±0.2	APPLICATION SPEC	-	SIZE	CAGE CODE	DRAWING NO	RESTRICTED TO
2 PLC ±0.1			A 4	00779	C=2176385	
3 PLC ±						
4 PLC ±						
ANGLES ±5°	WEIGHT	-				
	CUSTOMER DRAWING		SCALE	40:1	SHEET	1 OF 2
					REV	C

REVISIONS					
P	LTR	DESCRIPTION	DATE	DWN	APVD
-		SEE SHEET 1	-	-	-

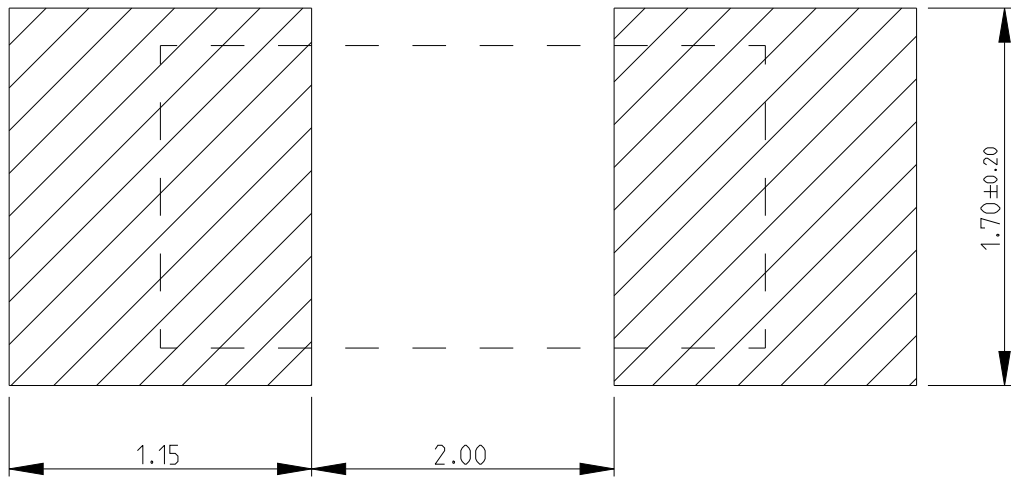

RECOMMENDED LAND PATTERN

© 2020 TE Connectivity. All Rights Reserved.

DIMENSIONS: mm	DWN GANESH C M	21MAY2018	MATERIAL	-	FINISH	-
	CHK ALLAN.P	21MAY2018				
TOLERANCES UNLESS OTHERWISE SPECIFIED: 0 PLC ±0.5 1 PLC ±0.2 2 PLC ±0.1 3 PLC ± 4 PLC ± ANGLES ±5°	APVD ALLAN.P	21MAY2018				
	PRODUCT SPEC	-	SIZE	CAGE CODE	DRAWING NO	RESTRICTED TO
	APPLICATION SPEC	-	A 4	00779	C=2176385	
	WEIGHT	-	CUSTOMER DRAWING		SCALE	40:1
			SHEET		2 OF 2	REV
						C