

REVISIONS

P	LTR	DESCRIPTION	DATE	DWN	APVD
	A	NEW DRAWING	05JUL2022	LG	AP

NOTES:

1. PCB WITH A COPPER THICKNESS OF TWO OUNCES SHOULD BE USED.
2. FOR FURTHER INFORMATION SEE DATA SHEET FOR 3504 SERIES ALUMINIUM NITRIDE THIN FILM POWER RESISTORS.

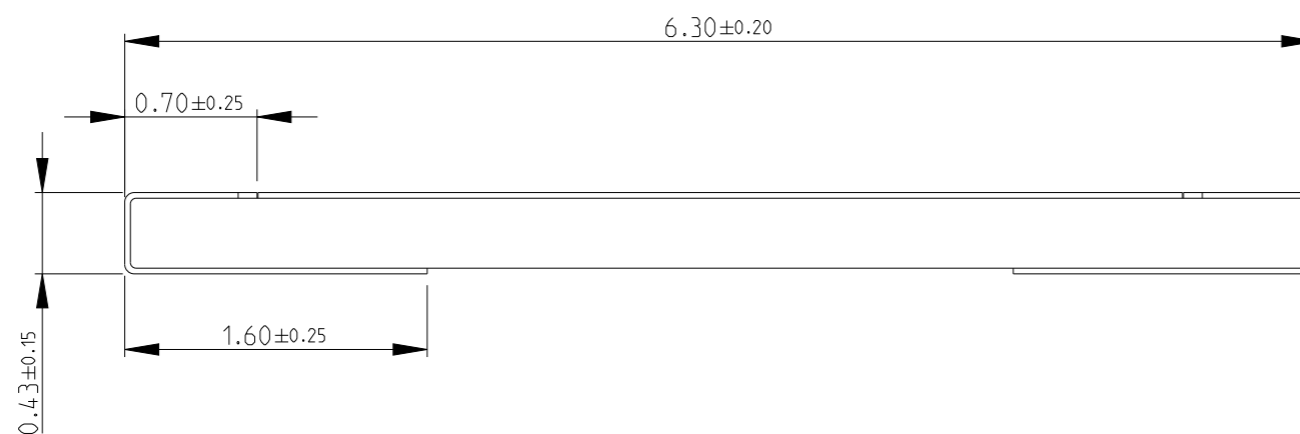
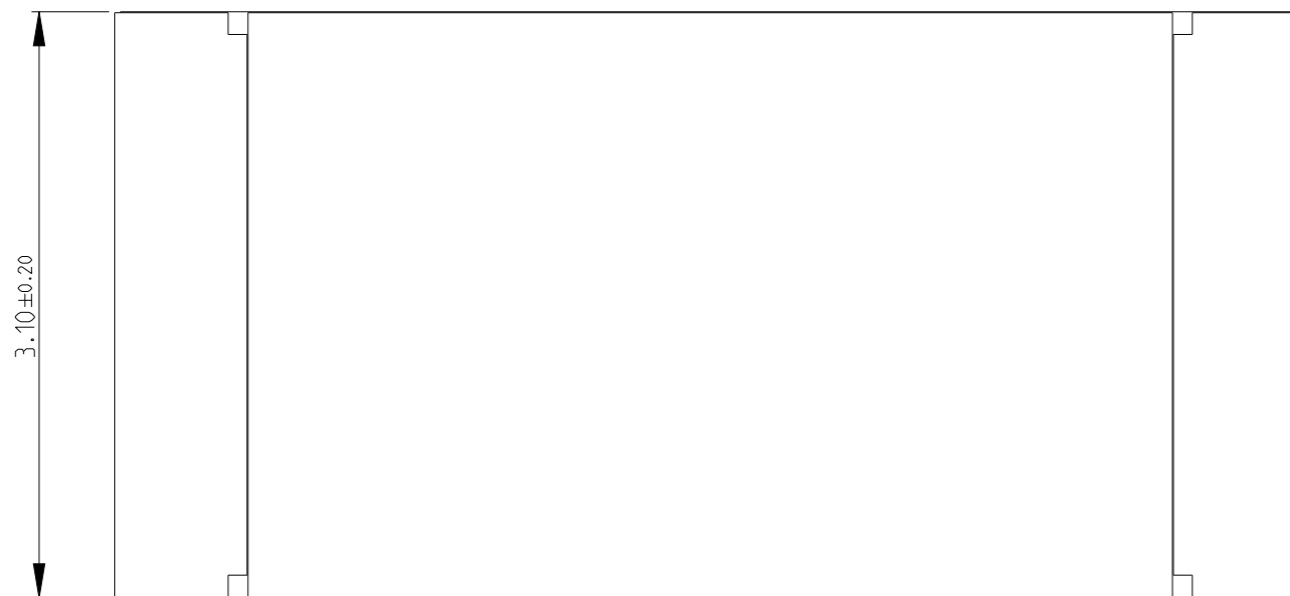

RoHS Compliant

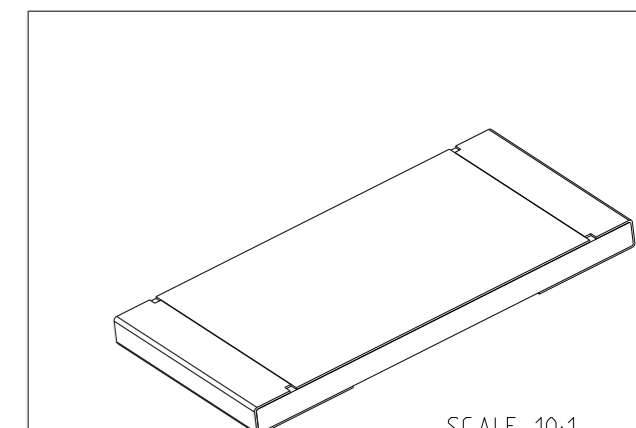

SCALE 10:1

RECOMMENDED LAND PATTERN

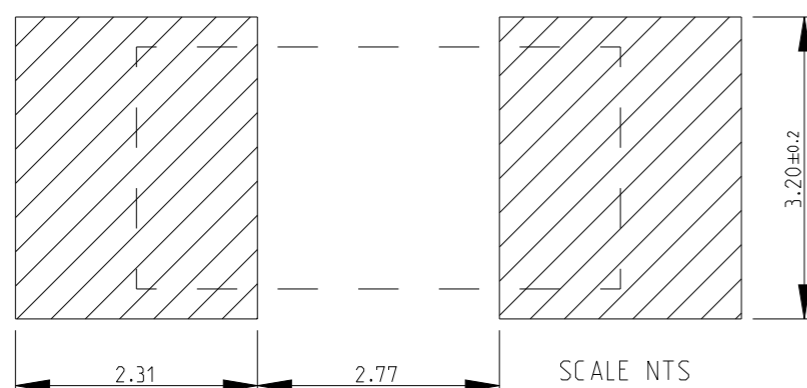

THIS DRAWING IS A CONTROLLED DOCUMENT.

DIMENSIONS:
mm

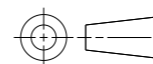

TOLERANCES UNLESS OTHERWISE SPECIFIED:

0 PLC	±0.5
1 PLC	±0.2
2 PLC	±0.1
3 PLC	±
4 PLC	±
ANGLES	±5°

MATERIAL

FINISH

-

-

DWN 05JUL2022

LALITH G

CHK 05JUL2022

ALLAN. P

APVD 05JUL2022

ALLAN. P

PRODUCT SPEC

-

APPLICATION SPEC

-

WEIGHT

-

NAME

ALUMINIUM NITRIDE THIN FILM POWER RESISTOR TYPE 3504 SERIES

SIZE

A3

CAGE CODE

00779

DRAWING NO

C=2176530

RESTRICTED TO

-

CUSTOMER DRAWING

SCALE 25:1

SHEET 1 OF 3

REV A

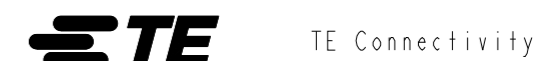

REVISIONS

P	LTR	DESCRIPTION	DATE	DWN	APVD
	-	SEE SHEET 1	-	-	-

SCHEDULE

TCPN	CATALOGUE NUMBER	PART DESCRIPTION	PART STATUS
2176530-1	3504G3A549RFTDF	3504G 3A 549R 1% 1K RL	PRODUCTION
2176530-2	3504G3A562RFTDF	3504G 3A 562R 1% 1K RL	PRODUCTION
2176530-3	3504G3A576RFTDF	3504G 3A 576R 1% 1K RL	PRODUCTION
2176530-4	3504G3A590RFTDF	3504G 3A 590R 1% 1K RL	PRODUCTION
2176530-5	3504G3A604RFTDF	3504G 3A 604R 1% 1K RL	PRODUCTION
2176530-6	3504G3A619RFTDF	3504G 3A 619R 1% 1K RL	PRODUCTION
2176530-7	3504G3A634RFTDF	3504G 3A 634R 1% 1K RL	PRODUCTION
2176530-8	3504G3A649RFTDF	3504G 3A 649R 1% 1K RL	PRODUCTION
2176530-9	3504G3A665RFTDF	3504G 3A 665R 1% 1K RL	PRODUCTION
1-2176530-0	3504G3A681RFTDF	3504G 3A 681R 1% 1K RL	PRODUCTION
1-2176530-1	3504G3A698RFTDF	3504G 3A 698R 1% 1K RL	PRODUCTION
1-2176530-2	3504G3A715RFTDF	3504G 3A 715R 1% 1K RL	PRODUCTION
1-2176530-3	3504G3A732RFTDF	3504G 3A 732R 1% 1K RL	PRODUCTION
1-2176530-4	3504G3A750RFTDF	3504G 3A 750R 1% 1K RL	PRODUCTION
1-2176530-5	3504G3A768RFTDF	3504G 3A 768R 1% 1K RL	PRODUCTION
1-2176530-6	3504G3A787RFTDF	3504G 3A 787R 1% 1K RL	PRODUCTION
1-2176530-7	3504G3A806RFTDF	3504G 3A 806R 1% 1K RL	PRODUCTION
1-2176530-8	3504G3A825RFTDF	3504G 3A 825R 1% 1K RL	PRODUCTION
1-2176530-9	3504G3A845RFTDF	3504G 3A 845R 1% 1K RL	PRODUCTION
2-2176530-0	3504G3A866RFTDF	3504G 3A 866R 1% 1K RL	PRODUCTION
2-2176530-1	3504G3A887RFTDF	3504G 3A 887R 1% 1K RL	PRODUCTION
2-2176530-2	3504G3A909RFTDF	3504G 3A 909R 1% 1K RL	PRODUCTION
2-2176530-3	3504G3A931RFTDF	3504G 3A 931R 1% 1K RL	PRODUCTION
2-2176530-4	3504G3A953RFTDF	3504G 3A 953R 1% 1K RL	PRODUCTION
2-2176530-5	3504G3A976RFTDF	3504G 3A 976R 1% 1K RL	PRODUCTION
2-2176530-6	3504G3A1K0FTDF	3504G 3A 1K0 1% 1K RL	PRODUCTION
2-2176530-7	3504G3A1K02FTDF	3504G 3A 1K02 1% 1K RL	PRODUCTION
2-2176530-8	3504G3A1K05FTDF	3504G 3A 1K05 1% 1K RL	PRODUCTION
2-2176530-9	3504G3A1K07FTDF	3504G 3A 1K07 1% 1K RL	PRODUCTION
3-2176530-0	3504G3A1K1FTDF	3504G 3A 1K1 1% 1K RL	PRODUCTION

SCHEDULE

TCPN	CATALOGUE NUMBER	PART DESCRIPTION	PART STATUS
3-2176530-1	3504G3A1K13FTDF	3504G 3A 1K13 1% 1K RL	PRODUCTION
3-2176530-2	3504G3A1K15FTDF	3504G 3A 1K15 1% 1K RL	PRODUCTION
3-2176530-3	3504G3A1K18FTDF	3504G 3A 1K18 1% 1K RL	PRODUCTION
3-2176530-4	3504G3A1K21FTDF	3504G 3A 1K21 1% 1K RL	PRODUCTION
3-2176530-5	3504G3A1K24FTDF	3504G 3A 1K24 1% 1K RL	PRODUCTION
3-2176530-6	3504G3A1K27FTDF	3504G 3A 1K27 1% 1K RL	PRODUCTION
3-2176530-7	3504G3A1K3FTDF	3504G 3A 1K3 1% 1K RL	PRODUCTION
3-2176530-8	3504G3A1K33FTDF	3504G 3A 1K33 1% 1K RL	PRODUCTION
3-2176530-9	3504G3A1K37FTDF	3504G 3A 1K37 1% 1K RL	PRODUCTION
4-2176530-0	3504G3A1K4FTDF	3504G 3A 1K4 1% 1K RL	PRODUCTION
4-2176530-1	3504G3A1K43FTDF	3504G 3A 1K43 1% 1K RL	PRODUCTION
4-2176530-2	3504G3A1K47FTDF	3504G 3A 1K47 1% 1K RL	PRODUCTION
4-2176530-3	3504G3A1K5FTDF	3504G 3A 1K5 1% 1K RL	PRODUCTION
4-2176530-4	3504G3A1K54FTDF	3504G 3A 1K54 1% 1K RL	PRODUCTION
4-2176530-5	3504G3A1K58FTDF	3504G 3A 1K58 1% 1K RL	PRODUCTION
4-2176530-6	3504G3A1K62FTDF	3504G 3A 1K62 1% 1K RL	PRODUCTION
4-2176530-7	3504G3A1K65FTDF	3504G 3A 1K65 1% 1K RL	PRODUCTION
4-2176530-8	3504G3A1K69FTDF	3504G 3A 1K69 1% 1K RL	PRODUCTION
4-2176530-9	3504G3A1K74FTDF	3504G 3A 1K74 1% 1K RL	PRODUCTION
5-2176530-0	3504G3A1K78FTDF	3504G 3A 1K78 1% 1K RL	PRODUCTION
5-2176530-1	3504G3A1K82FTDF	3504G 3A 1K82 1% 1K RL	PRODUCTION
5-2176530-2	3504G3A1K87FTDF	3504G 3A 1K87 1% 1K RL	PRODUCTION
5-2176530-3	3504G3A1K91FTDF	3504G 3A 1K91 1% 1K RL	PRODUCTION
5-2176530-4	3504G3A1K96FTDF	3504G 3A 1K96 1% 1K RL	PRODUCTION
5-2176530-5	3504G3A2K0FTDF	3504G 3A 2K0 1% 1K RL	PRODUCTION
5-2176530-6	3504G3A2K05FTDF	3504G 3A 2K05 1% 1K RL	PRODUCTION
5-2176530-7	3504G3A2K1FTDF	3504G 3A 2K1 1% 1K RL	PRODUCTION
5-2176530-8	3504G3A2K15FTDF	3504G 3A 2K15 1% 1K RL	PRODUCTION
5-2176530-9	3504G3A2K21FTDF	3504G 3A 2K21 1% 1K RL	PRODUCTION
6-2176530-0	3504G3A2K26FTDF	3504G 3A 2K26 1% 1K RL	PRODUCTION

THIS DRAWING IS A CONTROLLED DOCUMENT.

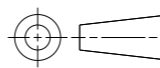
DIMENSIONS:	TOLERANCES UNLESS OTHERWISE SPECIFIED:
mm	
	0 PLC ±0.5
	1 PLC ±0.2
	2 PLC ±0.1
	3 PLC ±
	4 PLC ±
	ANGLES ±5°
MATERIAL	FINISH
-	-
-	-

DWN	LALITH G	05JUL2022
CHK	ALLAN. P	05JUL2022
APVD	ALLAN. P	05JUL2022
PRODUCT SPEC	-	-
APPLICATION SPEC	-	-
WEIGHT	-	-
CUSTOMER DRAWING		



ALUMINIUM NITRIDE THIN FILM POWER RESISTOR TYPE 3504 SERIES

SIZE	CAGE CODE	DRAWING NO	RESTRICTED TO
A3	00779	©=2176530	-
SCALE	SHEET	OF	REV
25:1	2	3	A

REVISIONS

P	LTR	DESCRIPTION	DATE	DWN	APVD
-		SEE SHEET 1	-	-	-

SCHEDULE

TCPN	CATALOGUE NUMBER	PART DESCRIPTION	PART STATUS
6-2176530-1	3504G3A2K32FTDF	3504G 3A 2K32 1% 1K RL	PRODUCTION
6-2176530-2	3504G3A2K37FTDF	3504G 3A 2K37 1% 1K RL	PRODUCTION
6-2176530-3	3504G3A2K43FTDF	3504G 3A 2K43 1% 1K RL	PRODUCTION
6-2176530-4	3504G3A2K49FTDF	3504G 3A 2K49 1% 1K RL	PRODUCTION
6-2176530-5	3504G3A2K55FTDF	3504G 3A 2K55 1% 1K RL	PRODUCTION
6-2176530-6	3504G3A2K61FTDF	3504G 3A 2K61 1% 1K RL	PRODUCTION
6-2176530-7	3504G3A2K67FTDF	3504G 3A 2K67 1% 1K RL	PRODUCTION
6-2176530-8	3504G3A2K74FTDF	3504G 3A 2K74 1% 1K RL	PRODUCTION
6-2176530-9	3504G3A2K8FTDF	3504G 3A 2K8 1% 1K RL	PRODUCTION
7-2176530-0	3504G3A2K87FTDF	3504G 3A 2K87 1% 1K RL	PRODUCTION
7-2176530-1	3504G3A2K94FTDF	3504G 3A 2K94 1% 1K RL	PRODUCTION
7-2176530-2	3504G3A3K01FTDF	3504G 3A 3K01 1% 1K RL	PRODUCTION
7-2176530-3	3504G3A3K09FTDF	3504G 3A 3K09 1% 1K RL	PRODUCTION
7-2176530-4	3504G3A3K16FTDF	3504G 3A 3K16 1% 1K RL	PRODUCTION
7-2176530-5	3504G3A3K24FTDF	3504G 3A 3K24 1% 1K RL	PRODUCTION
7-2176530-6	3504G3A3K32FTDF	3504G 3A 3K32 1% 1K RL	PRODUCTION
7-2176530-7	3504G3A3K4FTDF	3504G 3A 3K4 1% 1K RL	PRODUCTION
7-2176530-8	3504G3A3K48FTDF	3504G 3A 3K48 1% 1K RL	PRODUCTION
7-2176530-9	3504G3A3K57FTDF	3504G 3A 3K57 1% 1K RL	PRODUCTION
8-2176530-0	3504G3A3K65FTDF	3504G 3A 3K65 1% 1K RL	PRODUCTION
8-2176530-1	3504G3A3K74FTDF	3504G 3A 3K74 1% 1K RL	PRODUCTION
8-2176530-2	3504G3A3K83FTDF	3504G 3A 3K83 1% 1K RL	PRODUCTION
8-2176530-3	3504G3A3K92FTDF	3504G 3A 3K92 1% 1K RL	PRODUCTION
8-2176530-4	3504G3A4K02FTDF	3504G 3A 4K02 1% 1K RL	PRODUCTION
8-2176530-5	3504G3A4K12FTDF	3504G 3A 4K12 1% 1K RL	PRODUCTION
8-2176530-6	3504G3A4K22FTDF	3504G 3A 4K22 1% 1K RL	PRODUCTION
8-2176530-7	3504G3A4K32FTDF	3504G 3A 4K32 1% 1K RL	PRODUCTION
8-2176530-8	3504G3A4K42FTDF	3504G 3A 4K42 1% 1K RL	PRODUCTION
8-2176530-9	3504G3A4K53FTDF	3504G 3A 4K53 1% 1K RL	PRODUCTION
9-2176530-0	3504G3A4K64FTDF	3504G 3A 4K64 1% 1K RL	PRODUCTION
9-2176530-1	3504G3A4K75FTDF	3504G 3A 4K75 1% 1K RL	PRODUCTION
9-2176530-2	3504G3A4K87FTDF	3504G 3A 4K87 1% 1K RL	PRODUCTION
9-2176530-3	3504G3A4K99FTDF	3504G 3A 4K99 1% 1K RL	PRODUCTION
9-2176530-4	3504G3A5K11FTDF	3504G 3A 5K11 1% 1K RL	PRODUCTION
9-2176530-5	3504G3A5K23FTDF	3504G 3A 5K23 1% 1K RL	PRODUCTION
9-2176530-6	3504G3A5K36FTDF	3504G 3A 5K36 1% 1K RL	PRODUCTION
9-2176530-7	3504G3A5K49FTDF	3504G 3A 5K49 1% 1K RL	PRODUCTION
9-2176530-8	3504G3A5K62FTDF	3504G 3A 5K62 1% 1K RL	PRODUCTION
9-2176530-9	3504G3A5K76FTDF	3504G 3A 5K76 1% 1K RL	PRODUCTION

THIS DRAWING IS A CONTROLLED DOCUMENT.

DIMENSIONS:	
mm	
MATERIAL	
-	

TOLERANCES UNLESS OTHERWISE SPECIFIED:	
0 PLC	±0.5
1 PLC	±0.2
2 PLC	±0.1
3 PLC	±
4 PLC	±
ANGLES	±5°
FINISH	-
	-

DWN	LALITH G	05JUL2022
CHK	ALLAN. P	05JUL2022
APVD	ALLAN. P	05JUL2022
PRODUCT SPEC	-	
APPLICATION SPEC	-	
WEIGHT	-	
CUSTOMER DRAWING		

TE Connectivity

NAME
ALUMINIUM NITRIDE THIN FILM POWER RESISTOR TYPE 3504 SERIES

SIZE	CAGE CODE	DRAWING NO	RESTRICTED TO
A3	00779	©=2176530	-

SCALE 25:1 SHEET 3 OF 3 REV A