

RECOMMEND PCB LAYOUT
THE TOLERANCE UNLESS SPECIFIED IS ±0.05MM

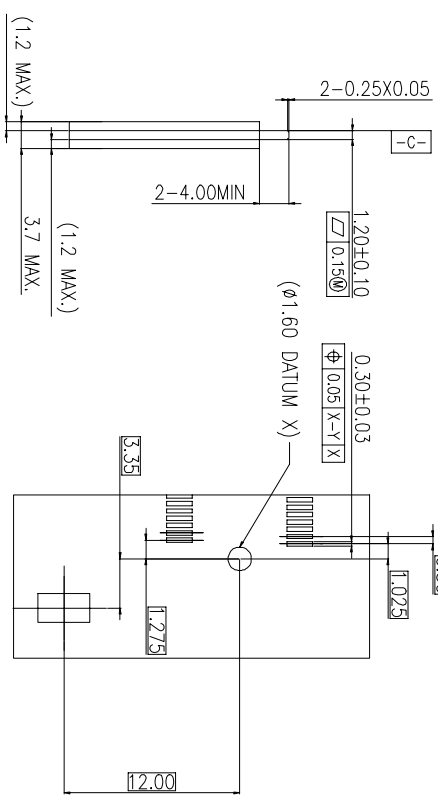

DETAIL:D
SCALE 2:1

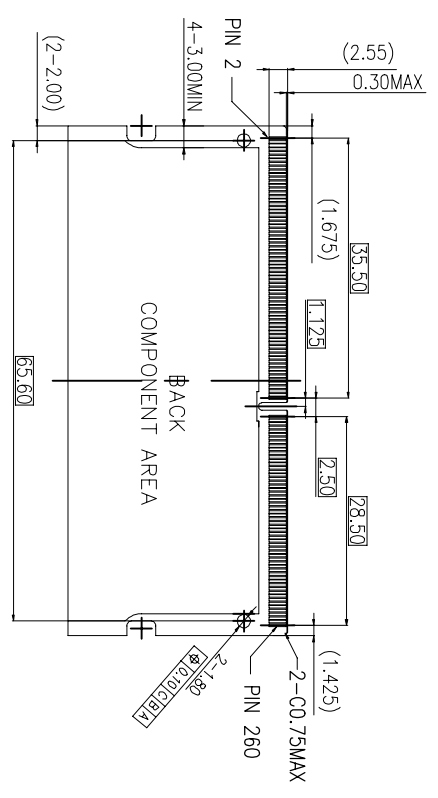
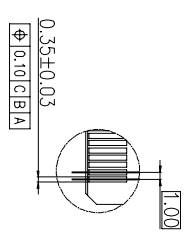

DETAIL:C
SCALE 2:1

THIS DRAWING IS A CONTROLLED DOCUMENT.		DATE	11MAR2021
DRAWN BY		CHK	11MAR2021
DIMENSIONS: mm		NAME	TE Connectivity
TOLERANCES UNLESS OTHERWISE SPECIFIED		PRODUCT SPEC	DRR4 SODIMM SOCKET
0 R/C	±	PRODUCT SPEC	0.5mm PITCH 260POS
1 R/C	±	APPLICATION SPEC	9.2mm HEIGHT STANDARD TYPE
2 R/C	±	WEIGHT	
3 R/C	±	CUSTOMER DRAWING	
4 R/C	±		
5 R/C	±		
6 R/C	±		
7 R/C	±		
8 R/C	±		
9 R/C	±		
10 R/C	±		
11 R/C	±		
12 R/C	±		
13 R/C	±		
14 R/C	±		
15 R/C	±		
16 R/C	±		
17 R/C	±		
18 R/C	±		
19 R/C	±		
20 R/C	±		
21 R/C	±		
22 R/C	±		
23 R/C	±		
24 R/C	±		
25 R/C	±		
26 R/C	±		
27 R/C	±		
28 R/C	±		
29 R/C	±		
30 R/C	±		
31 R/C	±		
32 R/C	±		
33 R/C	±		
34 R/C	±		
35 R/C	±		
36 R/C	±		
37 R/C	±		
38 R/C	±		
39 R/C	±		
40 R/C	±		
41 R/C	±		
42 R/C	±		
43 R/C	±		
44 R/C	±		
45 R/C	±		
46 R/C	±		
47 R/C	±		
48 R/C	±		
49 R/C	±		
50 R/C	±		
51 R/C	±		
52 R/C	±		
53 R/C	±		
54 R/C	±		
55 R/C	±		
56 R/C	±		
57 R/C	±		
58 R/C	±		
59 R/C	±		
60 R/C	±		
61 R/C	±		
62 R/C	±		
63 R/C	±		
64 R/C	±		
65 R/C	±		
66 R/C	±		
67 R/C	±		
68 R/C	±		
69 R/C	±		
70 R/C	±		
71 R/C	±		
72 R/C	±		
73 R/C	±		
74 R/C	±		
75 R/C	±		
76 R/C	±		
77 R/C	±		
78 R/C	±		
79 R/C	±		
80 R/C	±		
81 R/C	±		
82 R/C	±		
83 R/C	±		
84 R/C	±		
85 R/C	±		
86 R/C	±		
87 R/C	±		
88 R/C	±		
89 R/C	±		
90 R/C	±		
91 R/C	±		
92 R/C	±		
93 R/C	±		
94 R/C	±		
95 R/C	±		
96 R/C	±		
97 R/C	±		
98 R/C	±		
99 R/C	±		
100 R/C	±		

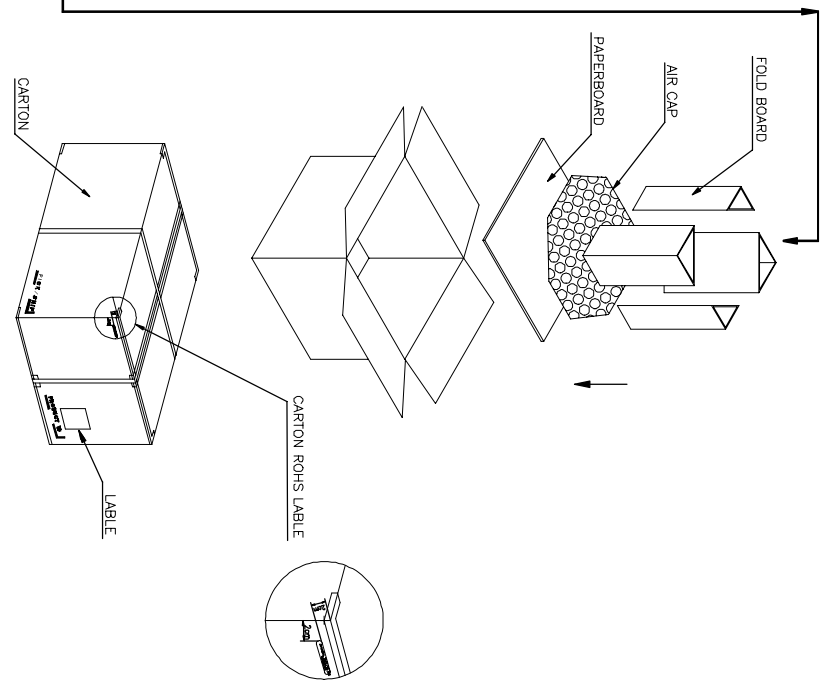
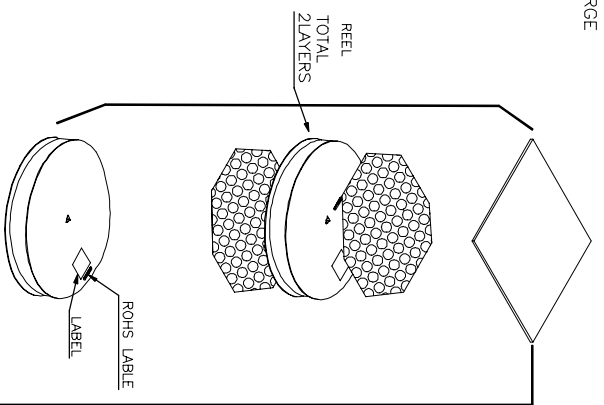
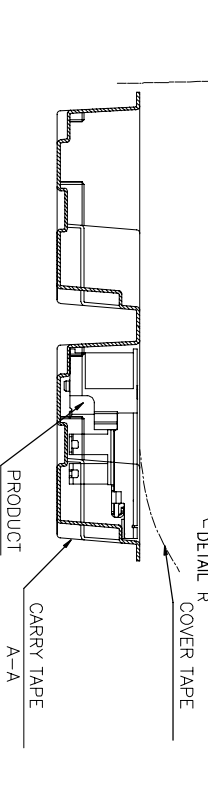
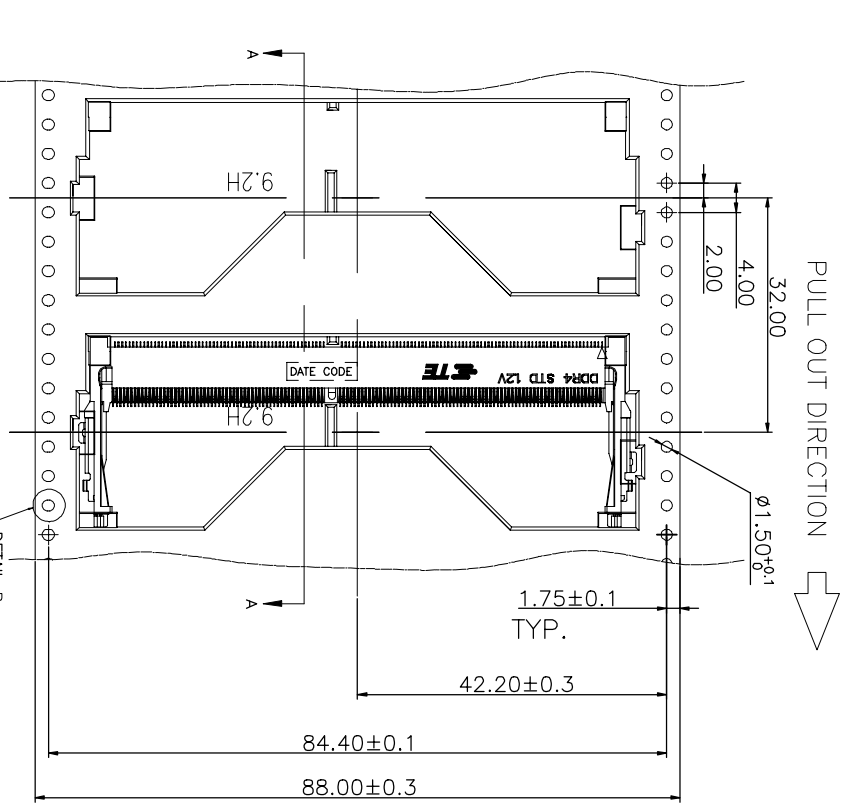
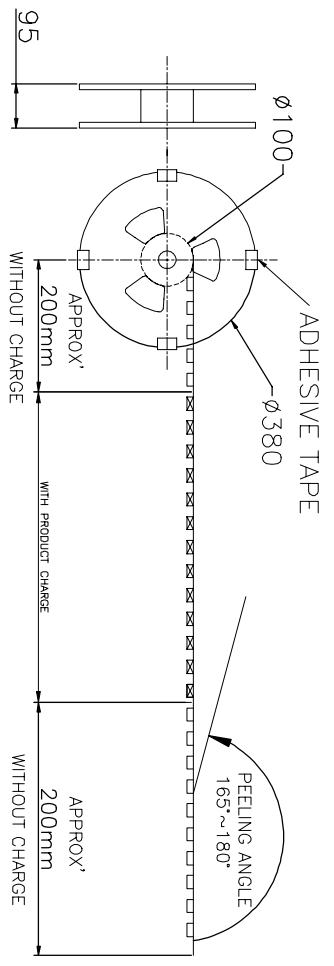

REVISIONS		DATE	QTN	APP'D
P	URL			

THIS DRAWING IS A CONTROLLED DOCUMENT		11MAR2021	11MAR2021	NAME	TE Connectivity
DIMENSIONS: mm		CHK	CHK	DESIGNER	
TOLERANCES UNLESS OTHERWISE SPECIFIED		RICHARD MA			
0 R.C	+	APPROVAL SPEC			
1 R.C	+	PRODUCT SPEC			
2 R.C	+	APPLICATION SPEC			
4 R.C	+	MATERIAL			
MATERIAL		CUSTOMER DRAWING			
SIZE		A2		00779	2309413
QTY		250		2	500
PCS/ REEL/ CARTON		REEL/ CARTON		PCS/ CARTON	PART NUMBER
DATE		2-1		3	7

2309413