

THIS DRAWING IS UNPUBLISHED. RELEASED FOR PUBLICATION 2018
 © COPYRIGHT 2018 BY - ALL RIGHTS RESERVED.

| REVISIONS | | | | | |
|-----------|-----|-----------------------------|-----------|-----|------|
| P | LTR | DESCRIPTION | DATE | DWN | APVD |
| B | | LOGO CHANGE; RESIN MARK ADD | 08AUG2018 | F.Z | R.B |
| C | | Obsolete 2-2333134-7 | 29APR2024 | R.W | R.B |
| | | | | | |
| | | | | | |

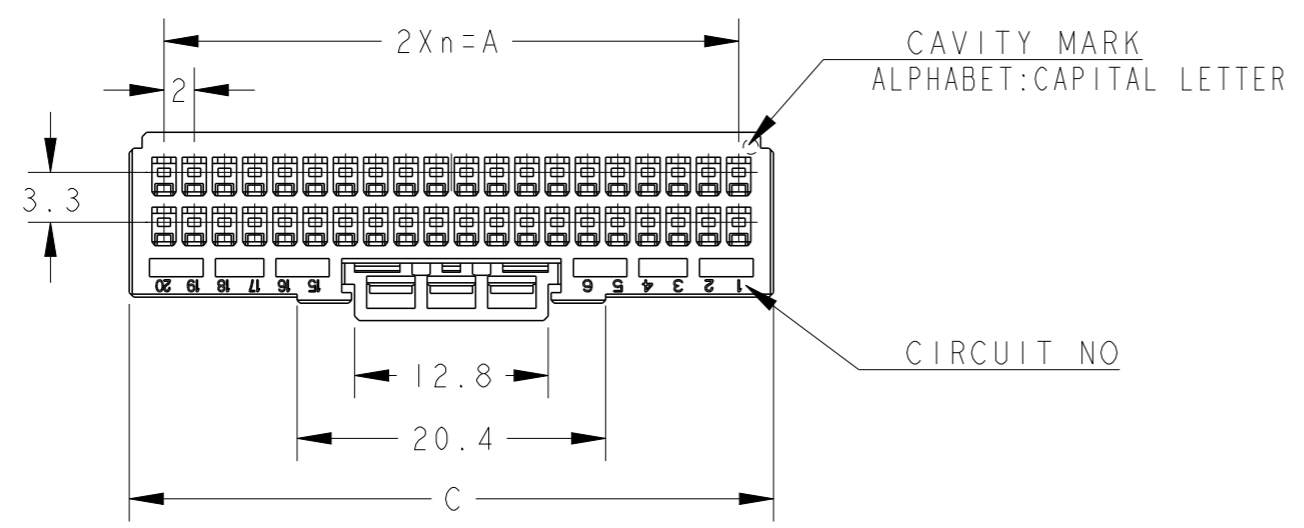

1. MATERIAL: GLASS FILED THERMO PLASTIC POLYESTER(94V-0), COLOR: BLACK
2. THE SHAPE, SIZE AND POSITION OF THE CHARACTER SHOW THE OUTLINE. THEY DON'T SHOW DETAILS.
3. THE KEYING ARRANGEMENT OF "Y" IS SYMMETRIC WITH "X".

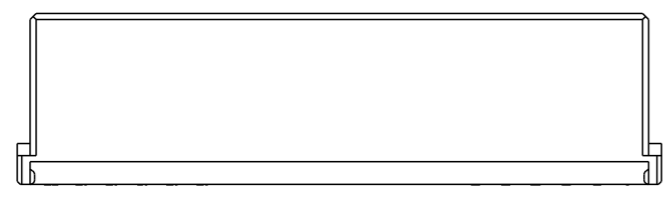
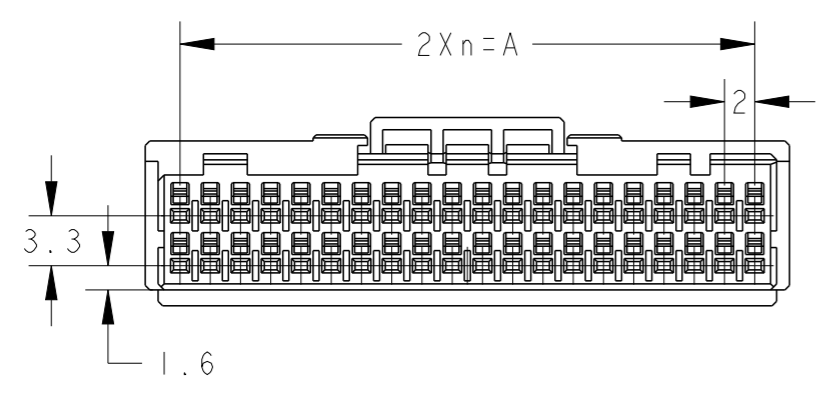
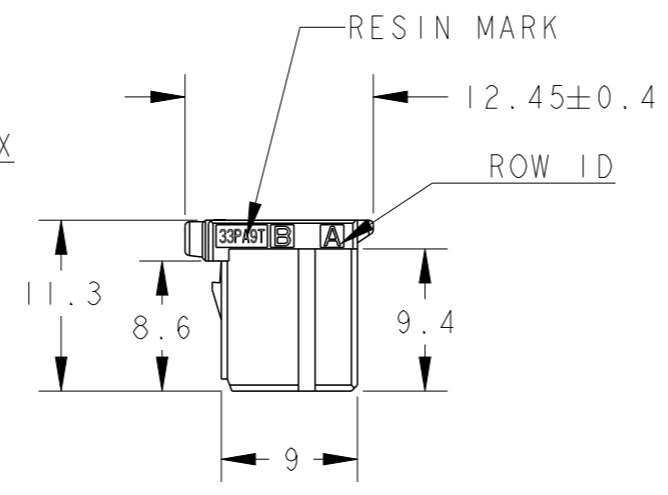
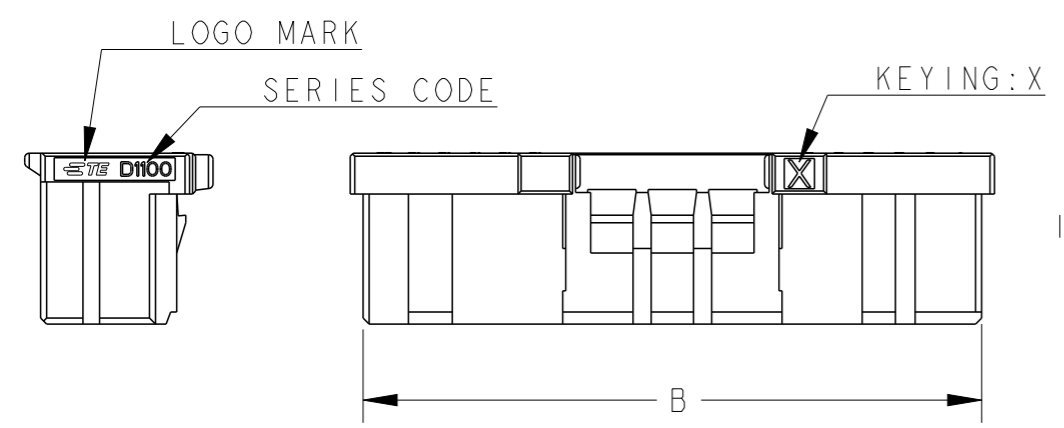

40POS(X-KEY): 1-2333134-0

Obsolete

| 40 | Y | 19 | 38.0 | 40.9 | 42.6 | 2-2333134-0 |
|-----|-----|----|------|------|------|-------------|
| 40 | X | 19 | 38.0 | 40.9 | 42.6 | 1-2333134-0 |
| 34 | Y | 16 | 32.0 | 34.9 | 36.6 | 2-2333134-7 |
| 34 | X | 16 | 32.0 | 34.9 | 36.6 | 1-2333134-7 |
| 32 | X | 15 | 30.0 | 32.9 | 34.6 | 1-2333134-6 |
| 30 | X | 14 | 28.0 | 30.9 | 32.6 | 1-2333134-5 |
| 28 | X | 13 | 26.0 | 28.9 | 30.6 | 1-2333134-4 |
| 26 | Y | 12 | 24.0 | 26.9 | 28.6 | 2-2333134-3 |
| 26 | X | 12 | 24.0 | 26.9 | 28.6 | 1-2333134-3 |
| 24 | X | 11 | 22.0 | 24.9 | 26.6 | 1-2333134-2 |
| 22 | X | 10 | 20.0 | 22.9 | 24.6 | 1-2333134-1 |
| POS | KEY | n | A | B | C | PART NO |

| | | | | | | |
|---|--|----------------------------------|------------------------------------|--------------------|-------------------------|---------------|
| THIS DRAWING IS A CONTROLLED DOCUMENT. | | DWN Fisher ZHU 29-Apr-24 | TE Connectivity | | | |
| DIMENSIONS: mm | | CHK Rick BIAN 29-Apr-24 | | | | |
| TOLERANCES UNLESS OTHERWISE SPECIFIED: ±0.3, ±5° | | APVD Rick BIAN 29-Apr-24 | NAME DYNAMIC D1100D 2.0mm PITCH | | | |
| 0 PLC ± 1 PLC ±0.3 2 PLC ±0.10 3 PLC ±0.001 4 PLC ±0.0001 ANGLES ± | | PRODUCT SPEC 108-78268, 78298 | REC HSG 22-40POS | | | |
| MATERIAL | | APPLICATION SPEC 114-5377 | SIZE A3 | CAGE CODE 00779 | DRAWING NO C-2333134 | RESTRICTED TO |
| FINISH | | WEIGHT - | SCALE 2:1 | | SHEET 1 OF 3 | REV C |
| CUSTOMER DRAWING | | | | | | |

REVISIONS

| P | LTR | DESCRIPTION | DATE | DWN | APVD |
|---|-----|-------------|------|-----|------|
| | | SEE SHEET 1 | | | |
| | | | | | |
| | | | | | |

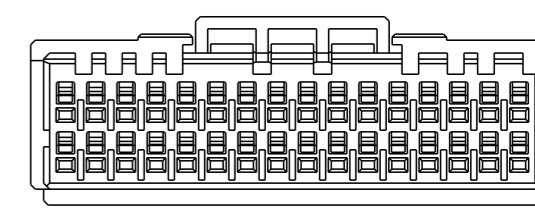
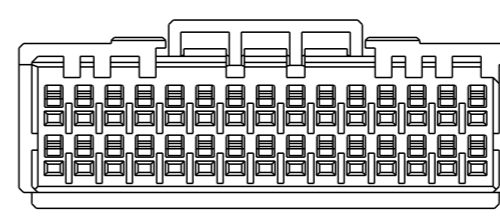
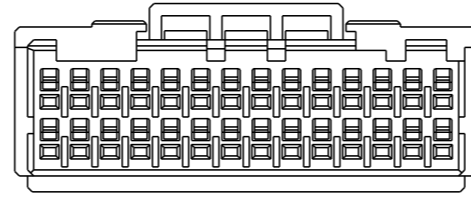
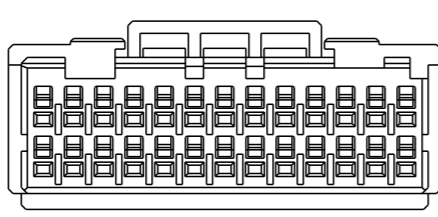
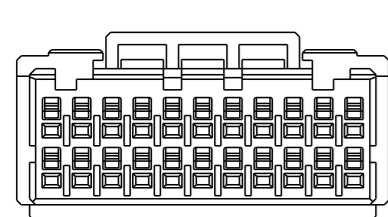
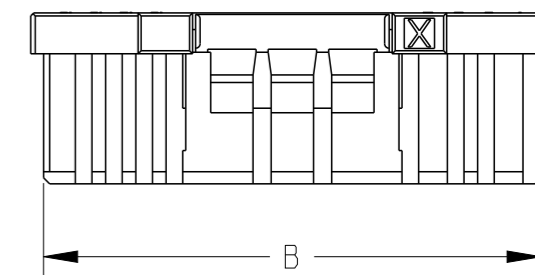
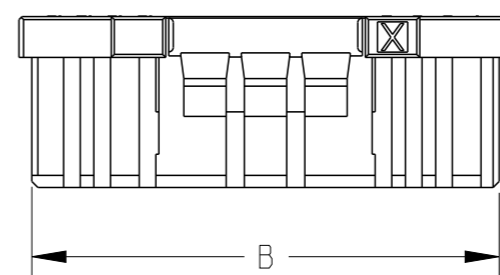
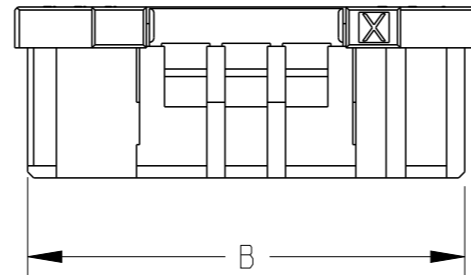
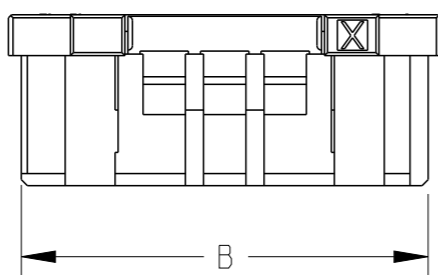
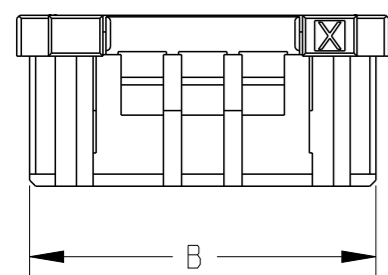
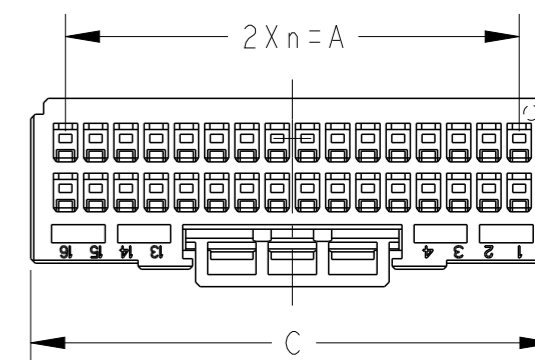
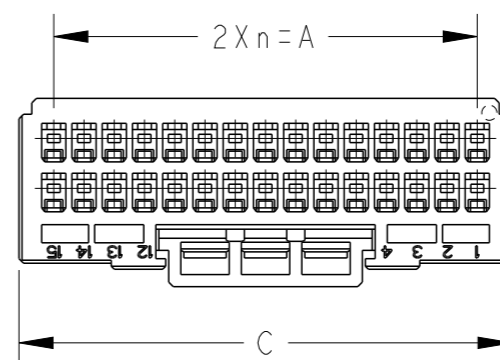
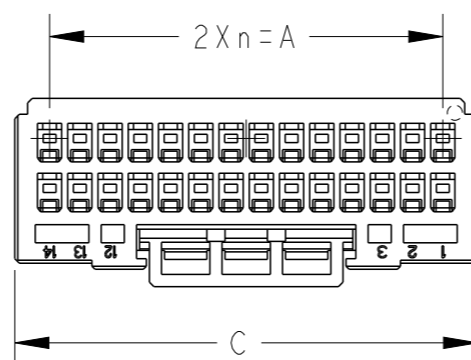
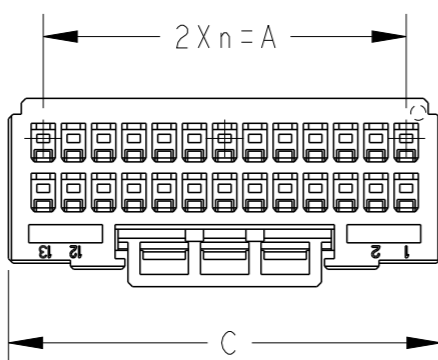
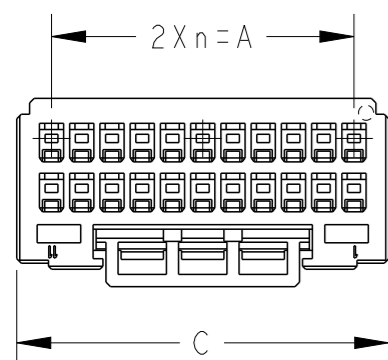

22POS(X-KEY): I-2333134-1

26POS(X-KEY): I-2333134-3

28POS(X-KEY): I-2333134-4

30POS(X-KEY): I-2333134-5

32POS(X-KEY): I-2333134-6

THIS DRAWING IS A CONTROLLED DOCUMENT.

DIMENSIONS:
mm



TOLERANCES UNLESS OTHERWISE SPECIFIED:

- 0 PLC ±
- 1 PLC ±
- 2 PLC ±
- 3 PLC ±
- 4 PLC ±
- ANGLES ±
- FINISH -

MATERIAL

SEE SHEET 1 OF 3

DWN 29-Apr-24
Fisher ZHU

CHK 29-Apr-24
Rick BIAN

APVD 29-Apr-24
Rick BIAN

PRODUCT SPEC
108-78268, 78298

APPLICATION SPEC
114-5377

WEIGHT -

CUSTOMER DRAWING



TE Connectivity

NAME
DYNAMIC D1100D 2.0mm PITCH
REC HSG
22-40POS

| | | | |
|------|-----------|------------|---------------|
| SIZE | CAGE CODE | DRAWING NO | RESTRICTED TO |
| A3 | 00779 | C-2333134 | |

SCALE 2:1 SHEET 2 OF 3 REV C

THIS DRAWING IS UNPUBLISHED.

RELEASED FOR PUBLICATION

2018

© COPYRIGHT 2018 BY -

ALL RIGHTS RESERVED.

REVISIONS

| P | LTR | DESCRIPTION | DATE | DWN | APVD |
|---|-----|-------------|------|-----|------|
| | | SEE SHEET 1 | | | |
| | | | | | |
| | | | | | |

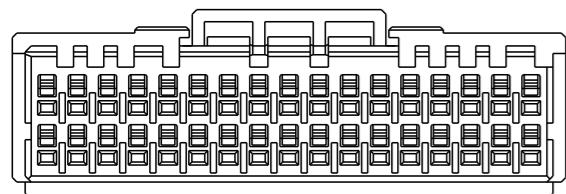
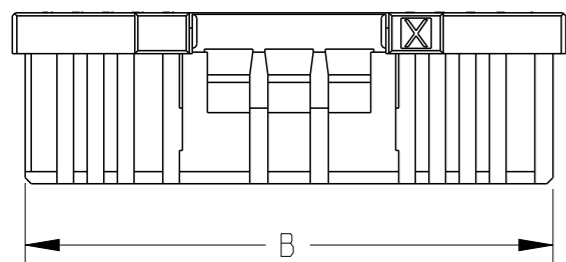
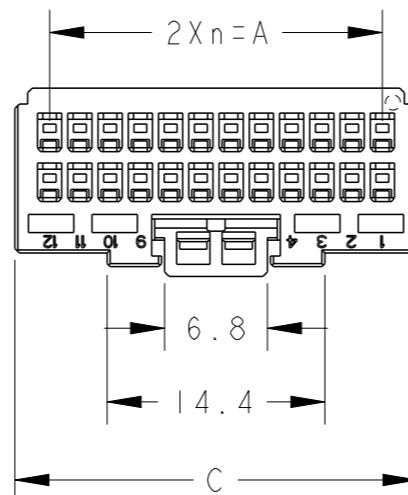
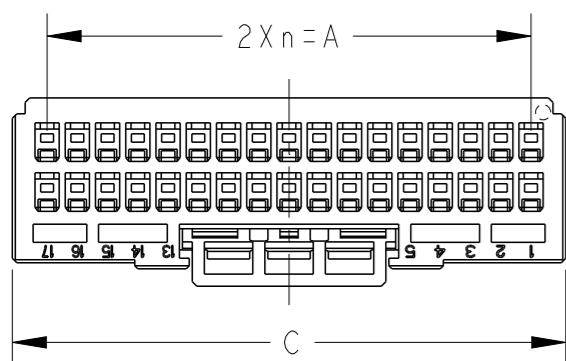

34POS(X-KEY): 1-2333134-7

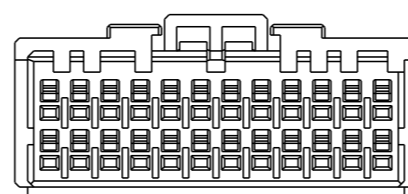
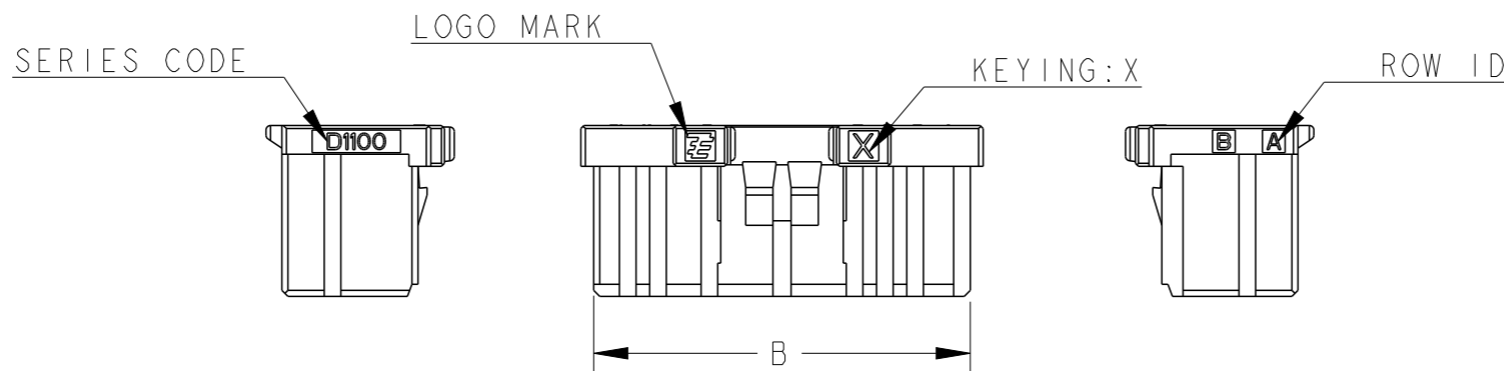

24POS(X-KEY): 1-2333134-2

THIS DRAWING IS A CONTROLLED DOCUMENT.

DIMENSIONS:
mm

TOLERANCES UNLESS OTHERWISE SPECIFIED:

- 0 PLC ±
- 1 PLC ±
- 2 PLC ±
- 3 PLC ±
- 4 PLC ±
- ANGLES ±
- FINISH -

MATERIAL

SEE SHEET 1 OF 3

DWN 29-Apr-24
Fisher ZHU

CHK 29-Apr-24
Rick BIAN

APVD 29-Apr-24
Rick BIAN

PRODUCT SPEC
108-78268, 78298

APPLICATION SPEC
114-5377

WEIGHT -

CUSTOMER DRAWING



NAME
DYNAMIC D1100D 2.0mm PITCH
REC HSG
22-40POS

SIZE CAGE CODE DRAWING NO RESTRICTED TO

A300779 C-2333134

SCALE 2:1 SHEET 3 OF 3 REV C