

REVISIONS				
P	LTN	DESCRIPTION	DATE	OWN APVD
A		PER ECO-18-020143	31DEC2018	MY GF
B		REV PER ECO-19-013251	28AUG2019	TS GF
-	-	-	-	-
-	-	-	-	-

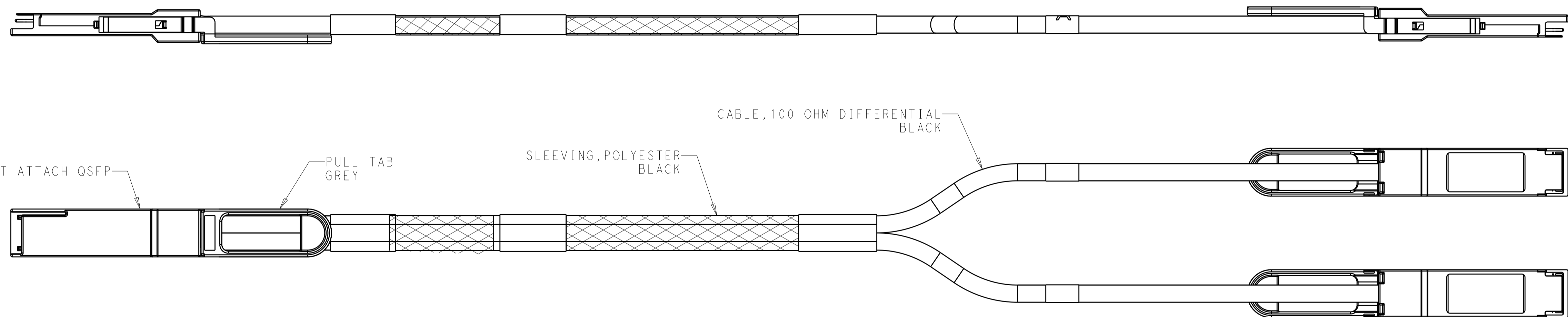

1 LABEL INFORMATION FOR 25 GIG PNS (-1 THRU -8): -1 SHOWN.

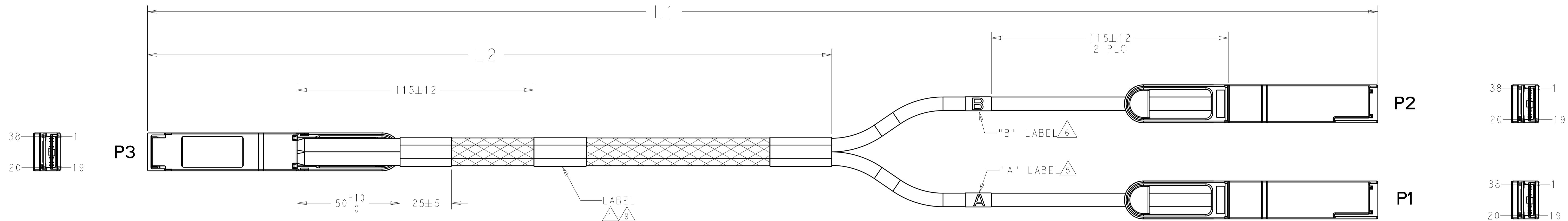
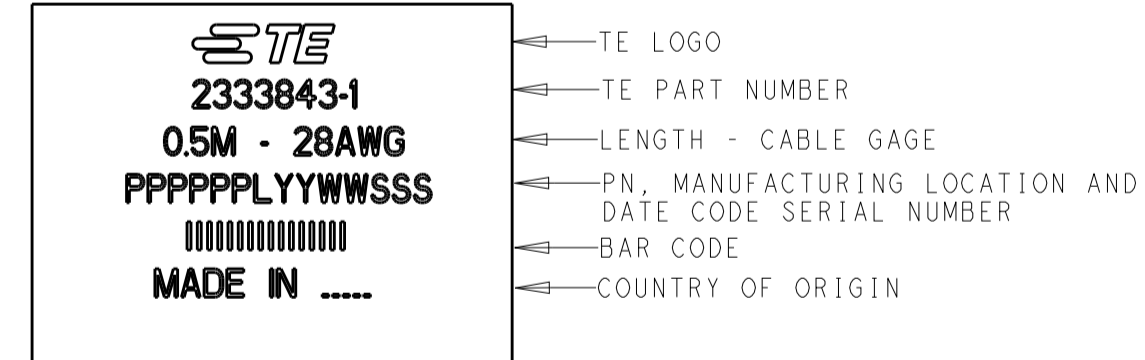

8 TEST IN ACCORDANCE WITH IEEE802.3bj.
 8 DASH NUMBER 41 THRU 45 CONFORM TO 56G, PAM-4 IEEE802.3CD PERFORMANCE REQUIREMENTS.
 9 LABEL INFORMATION FOR 56 GIG PNS (-41 THRU -45): -41 SHOWN.

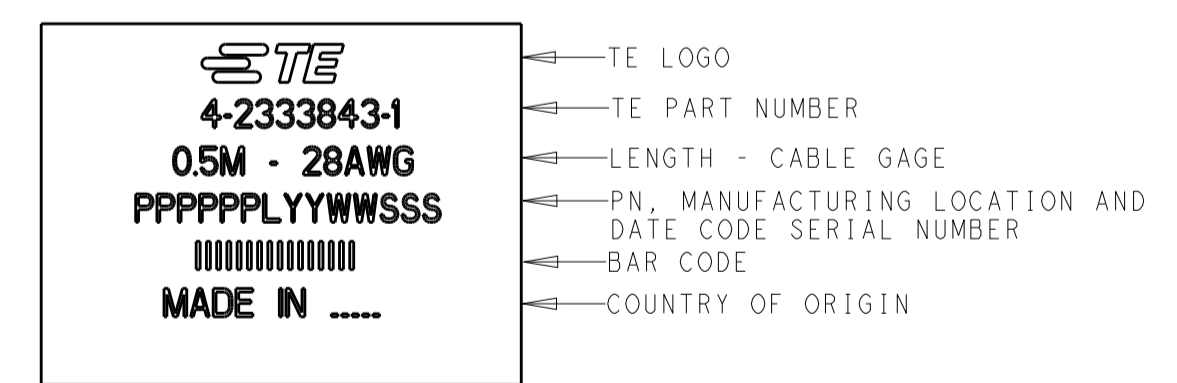

2. SEE SHEET 2 FOR WIRING SCHEMATIC.
 3. PRODUCT AND PROCESSING MUST MEET THE REQUIREMENTS OF TE SPECIFICATION TEC-138-702.
 4. CABLE ASSEMBLY TO BE TESTED FOR OPENS, SHORTS AND PROPER EEPROM PROGRAMMING.

10 NO SLEEVING REQUIRED FOR 0.5M LENGTH(2333843-1 AND 4-2333843-1).

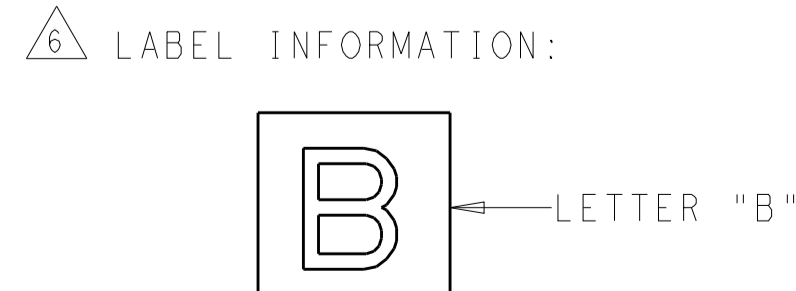
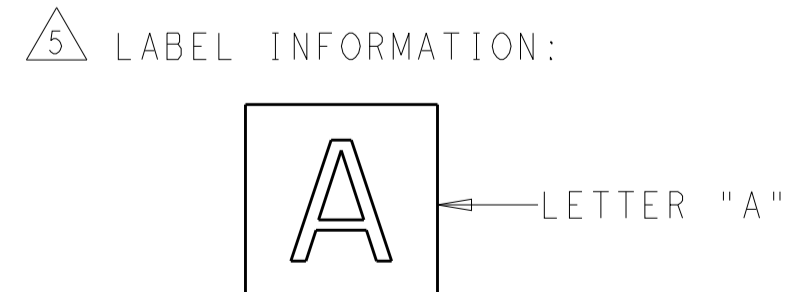

STANDAARD	GAGE	"L2" mm	"L1" mm	PART NO	
8	28	1000±25	2500 +80/-0	4-2333843-5	
	28	1000±25	2000 +80/-0	4-2333843-4	
	28	500±25	1500 +50/-0	4-2333843-3	
	28	500±25	1000 +50/-0	4-2333843-2	
	28	250±25	500 +50/-0	4-2333843-1	
	7	28	1500±25	4000 +80/-0	2333843-8
		28	1500±25	3500 +80/-0	2333843-7
		28	1000±25	3000 +80/-0	2333843-6
		28	1000±25	2500 +80/-0	2333843-5
		28	1000±25	2000 +80/-0	2333843-4
28		500±25	1500 +50/-0	2333843-3	
28		500±25	1000 +50/-0	2333843-2	
28		250±25	500 +50/-0	2333843-1	

THIS DRAWING IS A CONTROLLED DOCUMENT.

DIMENSIONS:	TOLERANCES UNLESS OTHERWISE SPECIFIED:	OWN: YI 05MAY2018	CHK: G. FRANKLIN 05MAY2018	APVD: G. FRANKLIN 05MAY2018	NAME: CABLE ASSEMBLY, QSFP TO (2) QSFP 25GIG, 28AWG
mm	0 PLC ± 1 PLC ± 2 PLC ± 3 PLC ± 4 PLC ± ANGLES ±	FINISH	WEIGHT	RESTRICTED TO	RESTRICTED TO
MATERIAL		SIZE: A100779	CAGE CODE: C=2333843	SCALE: 1:1	SHEET 1 OF 2
		RESTRICTED CUSTOMER			REV B

TE Connectivity

REVISIONS				
P.	LTN	DESCRIPTION	DATE	APVD
-	-	SEE SHEET 1	-	-

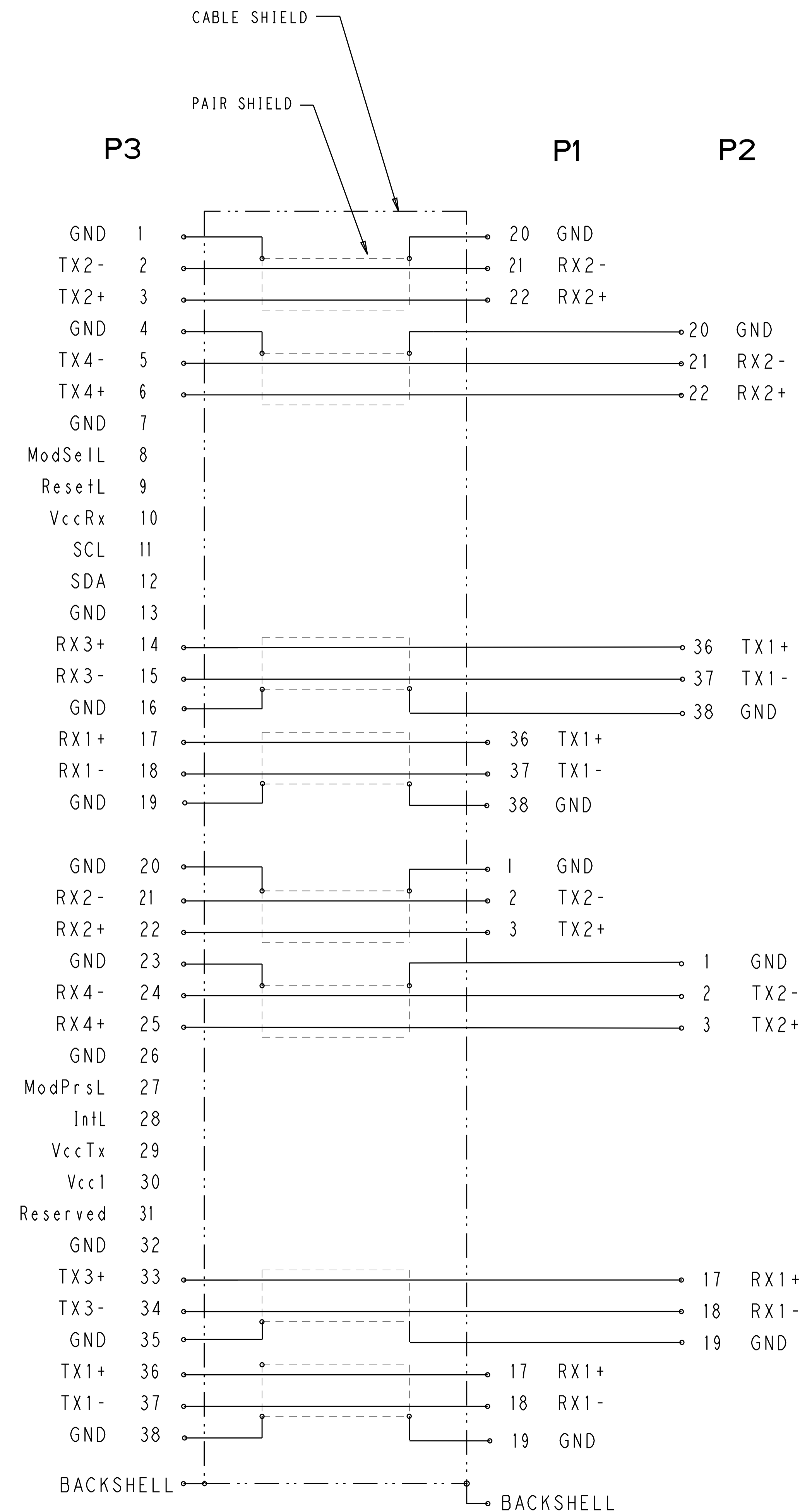

WIRING PATTERN

THIS DRAWING IS A CONTROLLED DOCUMENT.		DWN	Y1	05MAY2018	 TE Connectivity
		CHK	G. FRANKLIN	05MAY2018	
DIMENSIONS:		TOLERANCES UNLESS OTHERWISE SPECIFIED:		NAME	
mm	0 PLC ±	1 PLC ±	2 PLC ±	3 PLC ±	CABLE ASSEMBLY, QSFP TO (2) QSFP
	3 PLC ±	4 PLC ±	ANGLES ±	PRODUCT SPEC	25GIG, 28AWG
				APPLICATION SPEC	
MATERIAL		FINISH		WEIGHT	RESTRICTED TO
				RESTRICTED CUSTOMER	SIZE CAGE CODE DRAWING NO
					A100779C=2333843
				SCALE	1:2 SHEET 2 OF 2 REV B