

THIS DRAWING IS UNPUBLISHED. RELEASED FOR PUBLICATION 20
 © COPYRIGHT 20 BY - ALL RIGHTS RESERVED.

REVISIONS					
P	LTR	DESCRIPTION	DATE	DWN	APVD
A		A REVISION RELEASE	9JUNE2022	SY	HL
B		UPDATE HARD TRAY IN SHEET6	24NOV2022	MC	HL

NOTES:

- 1 MATERIAL:
 HOUSING: HIGH-TEMP PLASTIC; SEE COLOR IN SHEET 2 , UL 94V-0
 CONTACT: COPPER ALLOY
 SOLDER TAB: STAINLESS STEEL
- 2 FINISH:
 (SEE TABLE) 0.1 INCH GOLD PLATING OR GOLD FLASH OVER PdNi ON CONTACT AREA.
 2.54um MATTE-TIN PLATING ON SOLDER TAIL AREA.
 1.27um NICKEL UNDERPLATING OVERALL.
- 3 PCIE5, PART NUMBER AND DC PRINTED IN APPROPRIATE AREA OR OPPOSITE
- 4 SUCH CORE VOIDS PER MANUFACTURER'S CONVENIENCE.

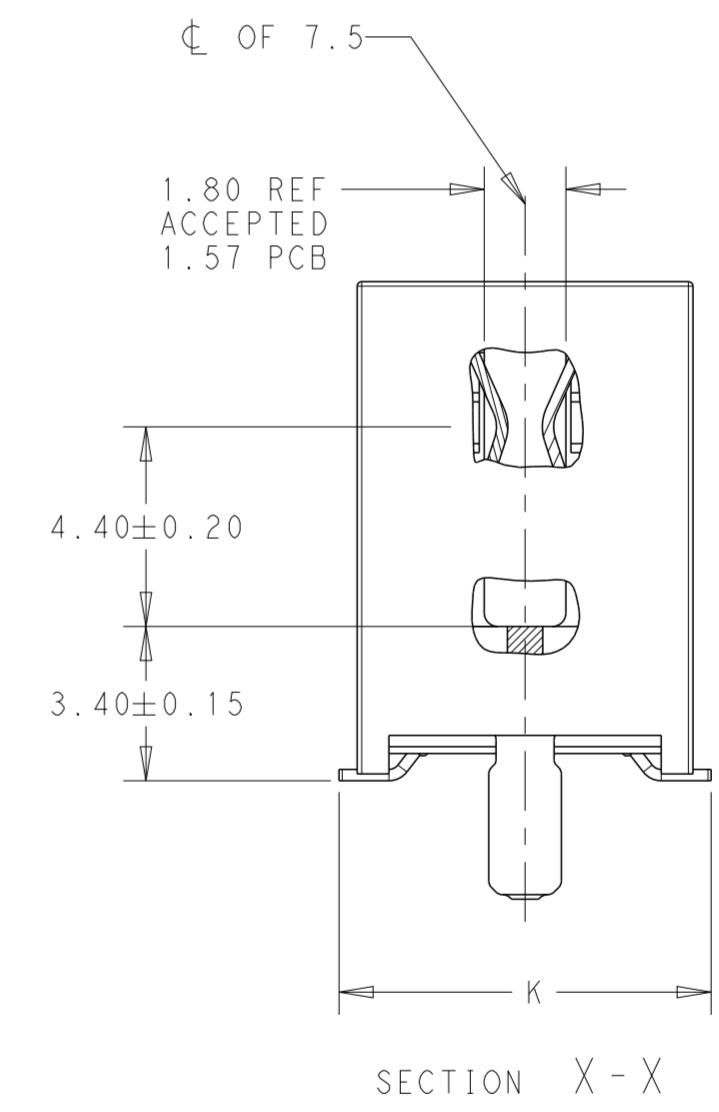
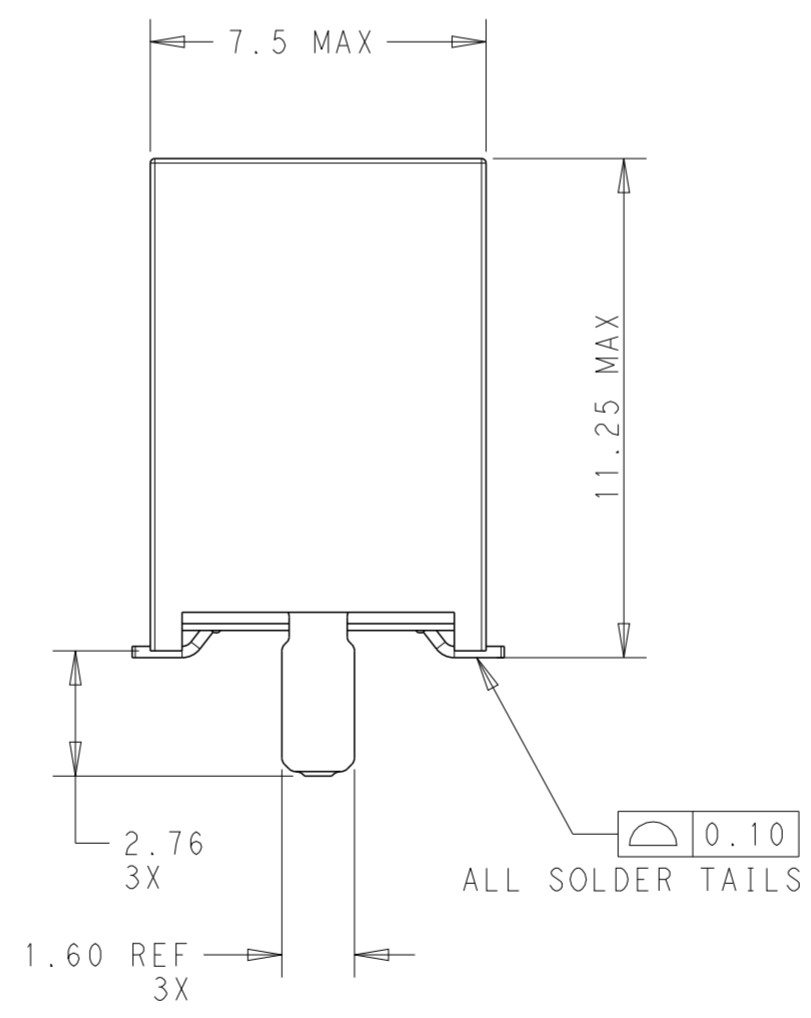
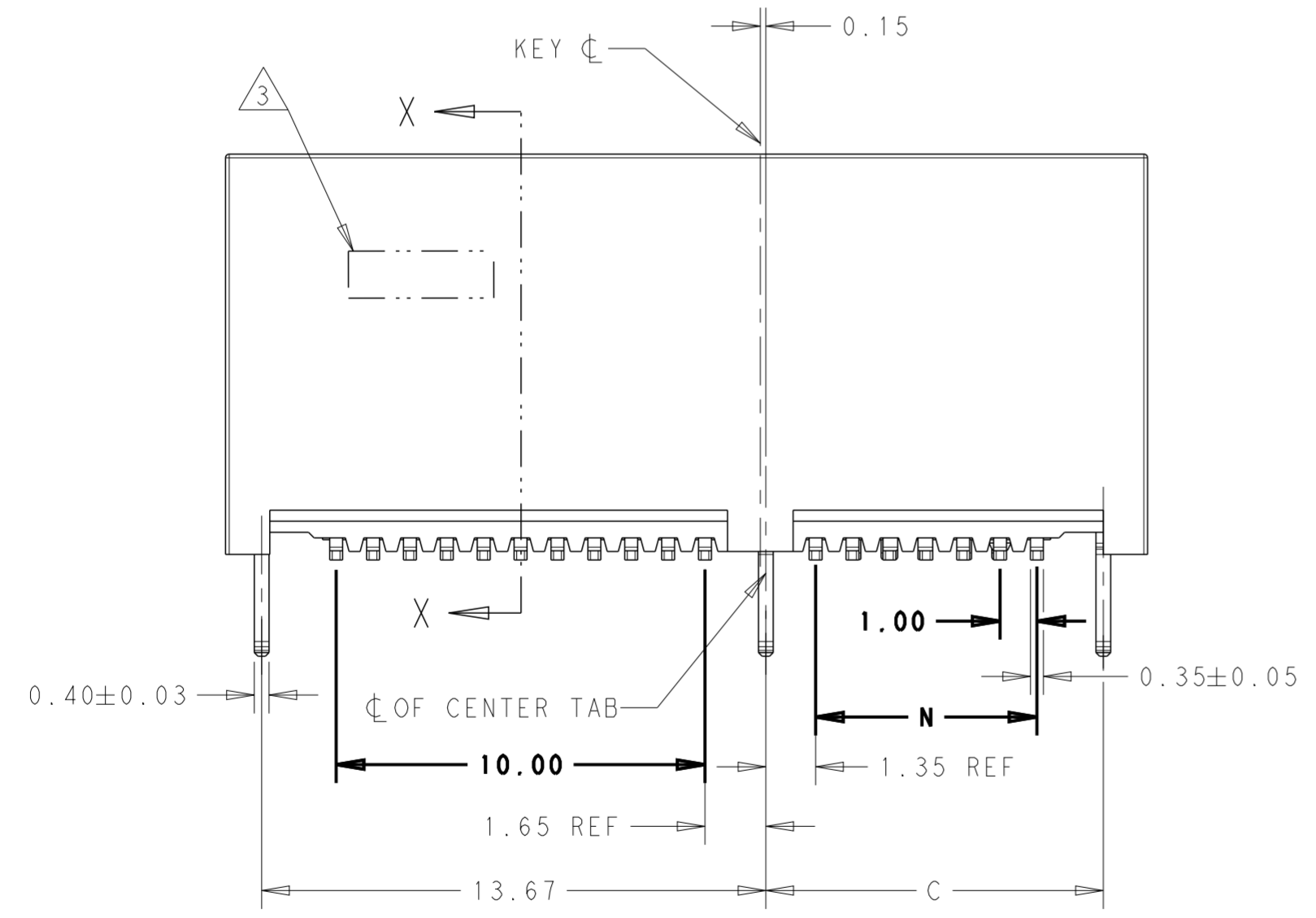
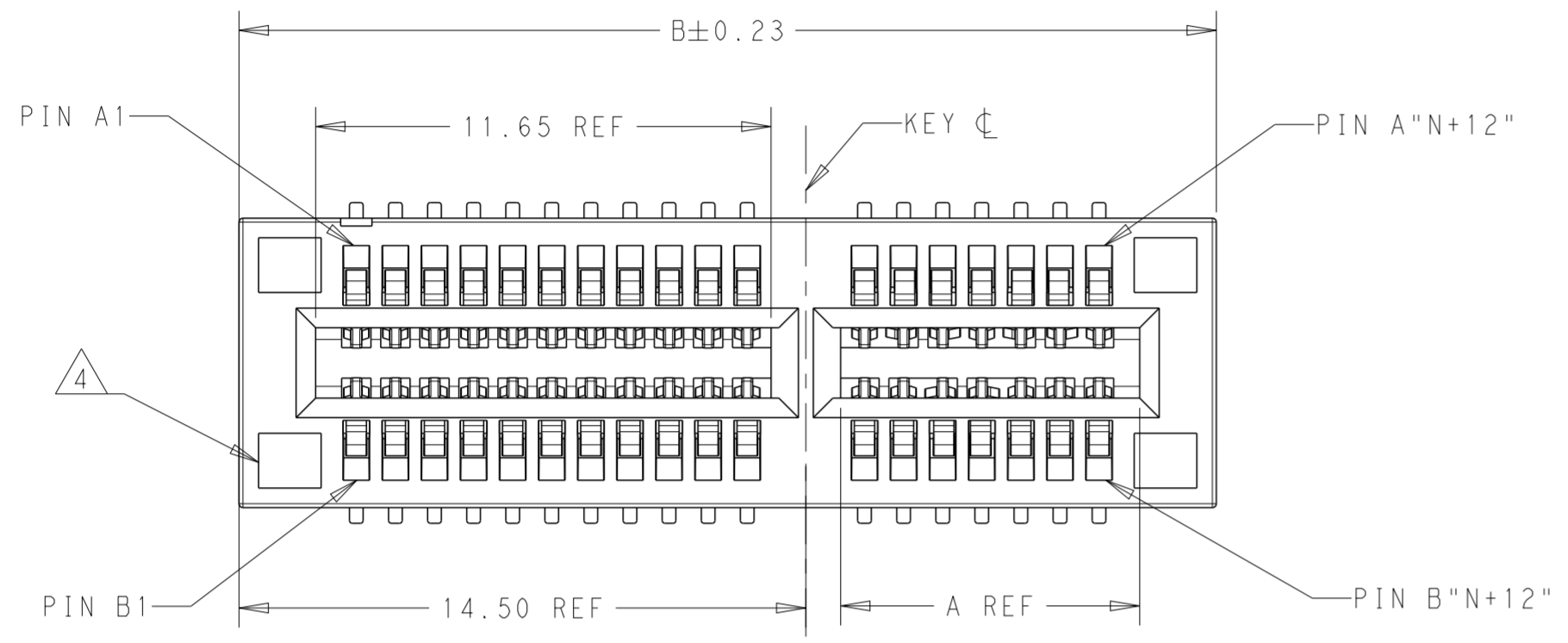

THIS DRAWING IS A CONTROLLED DOCUMENT.		DWN SANDERS YAN 13SEP2021	TE Connectivity	
		CHK MIKE CHEN 13SEP2021		
DIMENSIONS: mm		APVD HOPE LU 13SEP2021	NAME PCI EXPRESS CARD EDGE CONNECTOR GEN5, 2.76 SOLDER TAB, WITHOUT RIDGE	
TOLERANCES UNLESS OTHERWISE SPECIFIED:		PRODUCT SPEC 108-160247	SIZE CAGE CODE DRAWING NO RESTRICTED TO	
0 PLC ±		APPLICATION SPEC -	A200779 C-2399941	
1 PLC ±0.3		WEIGHT -	SCALE 6:1 SHEET 1 OF 7 REV B	
2 PLC ±0.20		CUSTOMER DRAWING		
3 PLC ±0.050				
4 PLC ±				
ANGLES ±				
FINISH				

THIS DRAWING IS UNPUBLISHED. RELEASED FOR PUBLICATION 20
 © COPYRIGHT 20 BY - ALL RIGHTS RESERVED.

REVISIONS					
P	LTR	DESCRIPTION	DATE	DWN	APVD
-	-	SEE SHEET 1	-	-	-

Q	P	COLOR	TYPE	L * W * H (TRAY)	PRECIOUS PLATING THICKNESS (TOTAL)	W	V	K	J	N	C	B	A	POS.	PART NUMBER
PCB LAYOUT	PCB LAYOUT			PACKAGE		MYLAR SIZE (PAGE 4)									
1.30	3.25	BLACK	HARD TRAY	323X136X19	30u"	86.5	8.0	7.40	44.5	70	73.15	89	71.65	164	9-2399941-8
2.0	3.60	BLUE	HARD TRAY	323X136X19	30u"	86.5	8.0	8.20	44.5	70	73.15	89	71.65	164	8-2399941-8
		BLACK	HARD TRAY	323X136X19	30u"	86.5	8.0		44.5	70	73.15	89	71.65	164	6-2399941-8
		BLACK	HARD TRAY	330X235X19.3	30u"	86.5	8.0		44.5	70	73.15	89	71.65	164	5-2399941-8
		BLACK	HARD TRAY	330X235X19.3	30u"	53.5	8.0		28	37	40.15	56	38.65	98	5-2399941-7
		BLACK	SOFT TRAY	338X235X20.3	30u"	36.5	8.0		19.5	20	23.15	39	21.65	64	5-2399941-6
		BLACK	SOFT TRAY	TBD	30u"	22.5	8.0		12.5	6	9.15	25	7.65	36	5-2399941-5
		BLACK	HARD TRAY	330X235X19.3	30u"	10.0	8.0		44.5	70	73.15	89	71.65	164	5-2399941-4
		BLACK	HARD TRAY	330X235X19.3	30u"	10.0	8.0		28	37	40.15	56	38.65	98	5-2399941-3
		BLACK	SOFT TRAY	338X235X20.3	30u"	10.0	8.0		19.5	20	23.15	39	21.65	64	5-2399941-2
		BLACK	SOFT TRAY	TBD	30u"	10.0	8.0		12.5	6	9.15	25	7.65	36	5-2399941-1
		BLACK	HARD TRAY	330X235X19.3	15u"	86.5	8.0		44.5	70	73.15	89	71.65	164	4-2399941-8
		BLACK	HARD TRAY	330X235X19.3	15u"	53.5	8.0		28	37	40.15	56	38.65	98	4-2399941-7
		BLACK	SOFT TRAY	338X235X20.3	15u"	36.5	8.0		19.5	20	23.15	39	21.65	64	4-2399941-6
		BLACK	SOFT TRAY	TBD	15u"	22.5	8.0		12.5	6	9.15	25	7.65	36	4-2399941-5
		BLACK	HARD TRAY	330X235X19.3	15u"	10.0	8.0		44.5	70	73.15	89	71.65	164	4-2399941-4
		BLACK	HARD TRAY	330X235X19.3	15u"	10.0	8.0		28	37	40.15	56	38.65	98	4-2399941-3
		BLACK	SOFT TRAY	338X235X20.3	15u"	10.0	8.0		19.5	20	23.15	39	21.65	64	4-2399941-2
		BLACK	SOFT TRAY	TBD	15u"	10.0	8.0		12.5	6	9.15	25	7.65	36	4-2399941-1
		BLACK	HARD TRAY	330X235X19.3	G/F	86.5	8.0		44.5	70	73.15	89	71.65	164	3-2399941-8
		BLACK	HARD TRAY	330X235X19.3	G/F	53.5	8.0		28	37	40.15	56	38.65	98	3-2399941-7
		BLACK	SOFT TRAY	338X235X20.3	G/F	36.5	8.0		19.5	20	23.15	39	21.65	64	3-2399941-6
		BLACK	SOFT TRAY	TBD	G/F	22.5	8.0		12.5	6	9.15	25	7.65	36	3-2399941-5
		BLACK	HARD TRAY	330X235X19.3	G/F	10.0	8.0		44.5	70	73.15	89	71.65	164	3-2399941-4
		BLACK	HARD TRAY	330X235X19.3	G/F	10.0	8.0		28	37	40.15	56	38.65	98	3-2399941-3
		BLACK	SOFT TRAY	338X235X20.3	G/F	10.0	8.0		19.5	20	23.15	39	21.65	64	3-2399941-2
		BLACK	SOFT TRAY	TBD	G/F	10.0	8.0		12.5	6	9.15	25	7.65	36	3-2399941-1
		BLACK	HARD TRAY	330X235X19.3	30u"		NA		44.5	70	73.15	89	71.65	164	2-2399941-4
		BLACK	HARD TRAY	330X235X19.3	30u"		NA		28	37	40.15	56	38.65	98	2-2399941-3
		BLACK	SOFT TRAY	338X235X20.3	30u"		NA		19.5	20	23.15	39	21.65	64	2-2399941-2
		BLACK	SOFT TRAY	TBD	30u"		NA		12.5	6	9.15	25	7.65	36	2-2399941-1
		BLACK	HARD TRAY	330X235X19.3	15u"		NA		44.5	70	73.15	89	71.65	164	1-2399941-4
		BLACK	HARD TRAY	330X235X19.3	15u"		NA		28	37	40.15	56	38.65	98	1-2399941-3
BLACK	SOFT TRAY	338X235X20.3	15u"		NA	19.5	20	23.15	39	21.65	64	1-2399941-2			
BLACK	SOFT TRAY	TBD	15u"		NA	12.5	6	9.15	25	7.65	36	1-2399941-1			
BLACK	HARD TRAY	330X235X19.3	G/F		NA	44.5	70	73.15	89	71.65	164	2399941-4			
BLACK	HARD TRAY	330X235X19.3	G/F		NA	28	37	40.15	56	38.65	98	2399941-3			
BLACK	SOFT TRAY	338X235X20.3	G/F		NA	19.5	20	23.15	39	21.65	64	2399941-2			
BLACK	SOFT TRAY	TBD	G/F		NA	12.5	6	9.15	25	7.65	36	2399941-1			

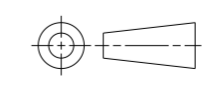
THIS DRAWING IS A CONTROLLED DOCUMENT.		DWN SANDERS YAN 13SEP2021	 TE Connectivity	
DIMENSIONS: mm		CHK MIKE CHEN 13SEP2021		
		APVD HOPE LU 13SEP2021	NAME PCI EXPRESS CARD EDGE CONNECTOR GEN5, 2.76 SOLDER TAB, WITHOUT RIDGE	
TOLERANCES UNLESS OTHERWISE SPECIFIED:		PRODUCT SPEC 108-160247	RESTRICTED TO	
0 PLC ±		APPLICATION SPEC	SIZE A2	CAGE CODE 00779
1 PLC ±0.3		WEIGHT	DRAWING NO C-2399941	SCALE 6:1
2 PLC ±0.20		CUSTOMER DRAWING	SHEET 2 OF 7	REV B
3 PLC ±0.050				
4 PLC ±				
ANGLES ±				
FINISH				

THIS DRAWING IS UNPUBLISHED. RELEASED FOR PUBLICATION 20
 © COPYRIGHT 20 BY - ALL RIGHTS RESERVED.

REVISIONS				
P	LTR	DESCRIPTION	DATE	APVD
-	-	SEE SHEET 1	-	-

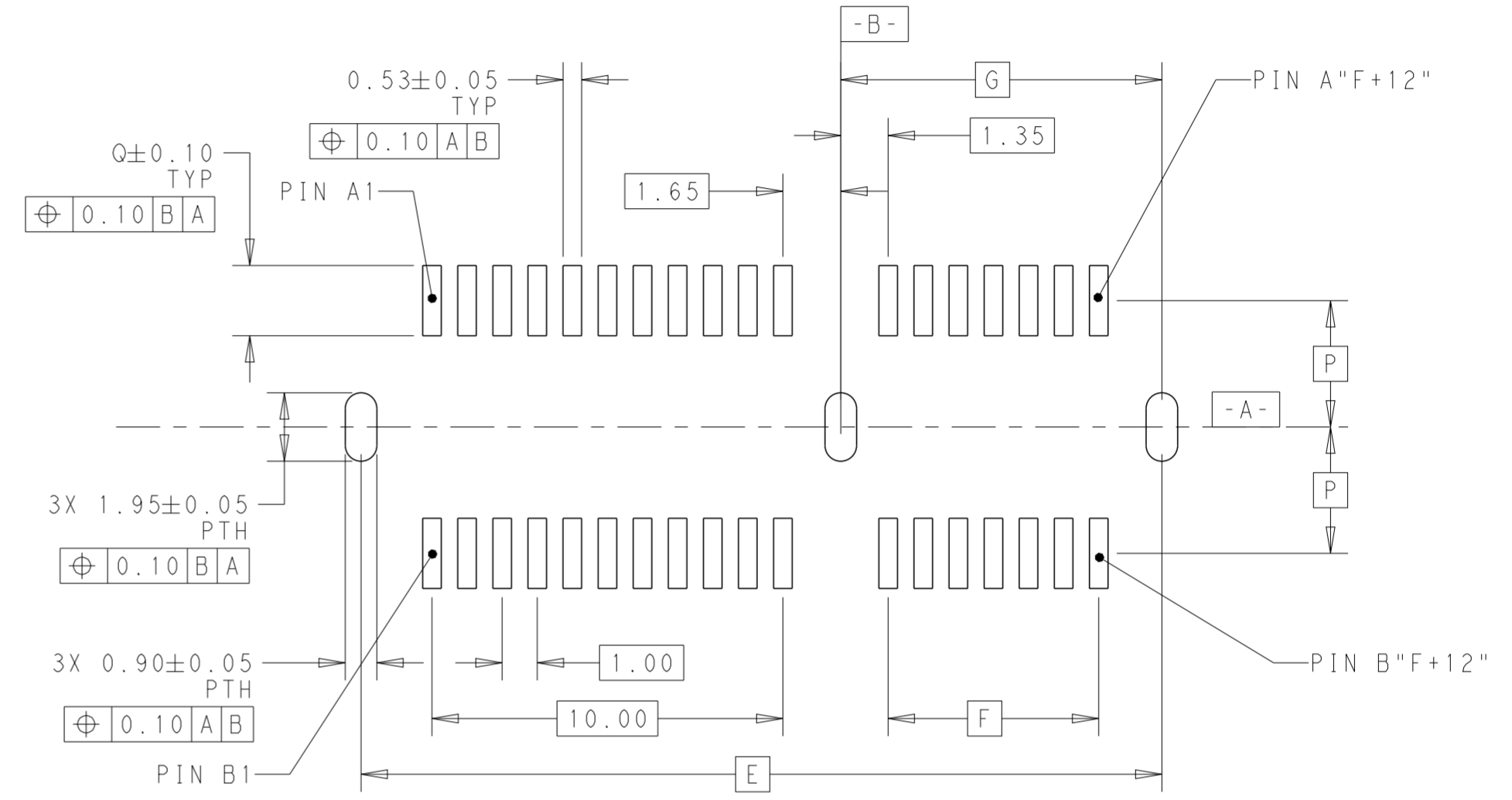
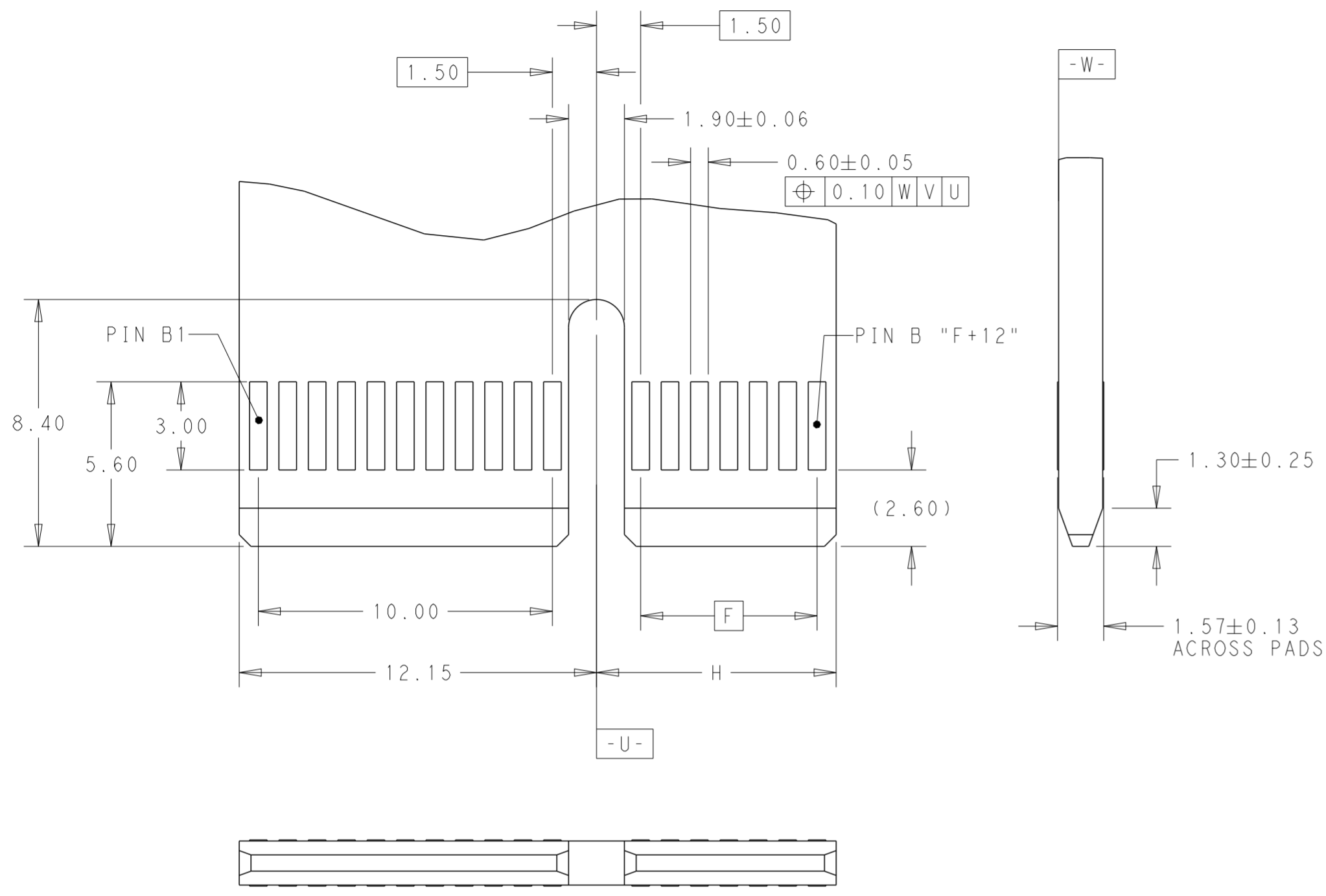

RECOMMENDED PCB LAYOUT (36POS AS SHOWN)

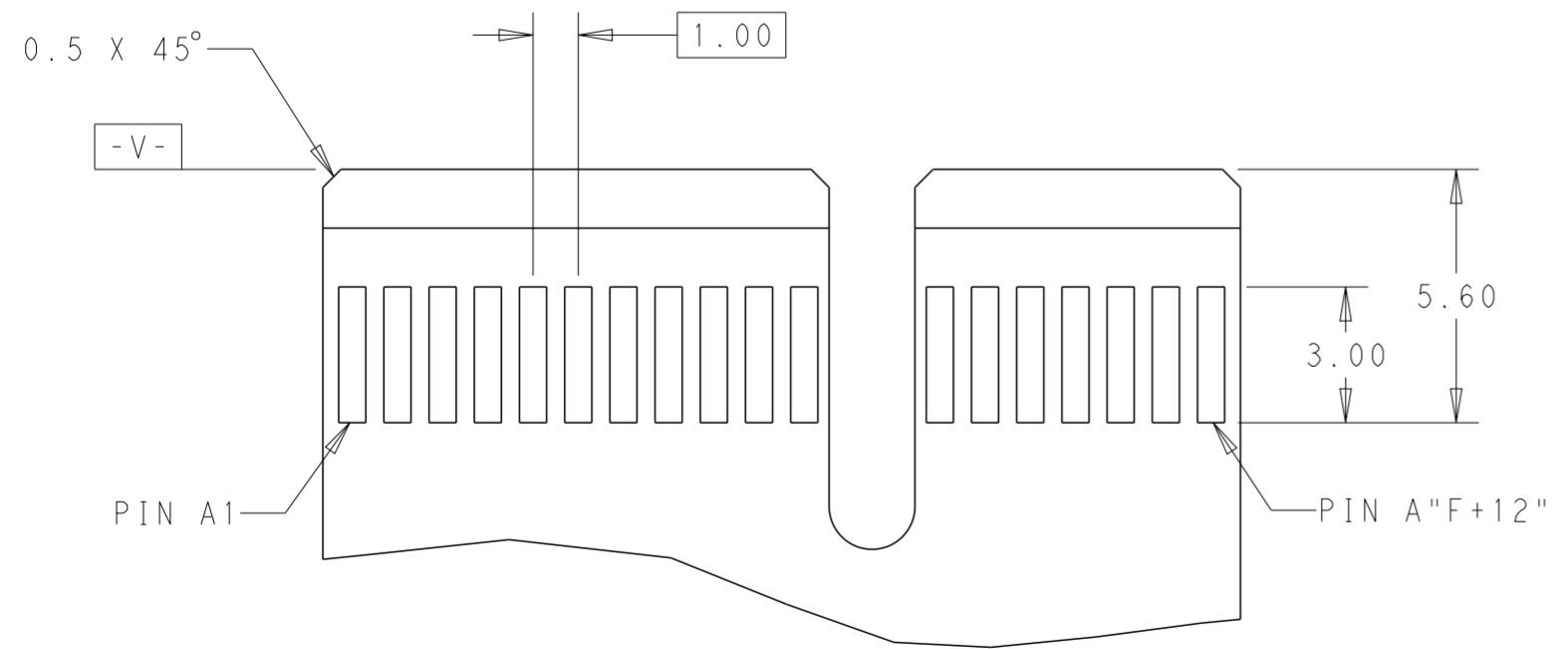

ADD-IN CARD EDGE-FINGER DIMENSION
 (36POS AS SHOWN)
 DEFAULT TOLERANCE ±0.13

164	86.82	70	73.15	72.15
98	53.82	37	40.15	39.15
64	36.82	20	23.15	22.15
36	22.82	6	9.15	8.15
POS.	DIM. E	DIM. F	DIM. G	DIM. H

THIS DRAWING IS A CONTROLLED DOCUMENT.		DWN SANDERS YAN 13SEP2021	TE Connectivity	
DIMENSIONS: mm		CHK MIKE CHEN 13SEP2021		
TOLERANCES UNLESS OTHERWISE SPECIFIED:		APVD HOPE LU 13SEP2021	NAME PCI EXPRESS CARD EDGE CONNECTOR GEN5, 2.76 SOLDER TAB, WITHOUT RIDGE	
0 PLC ± 1 PLC ±0.3 2 PLC ±0.20 3 PLC ±0.050 4 PLC ± ANGLES ± FINISH ±		PRODUCT SPEC 108-160247	SIZE CAGE CODE DRAWING NO RESTRICTED TO	
MATERIAL		APPLICATION SPEC	A200779 C-2399941	
		WEIGHT	SCALE 6:1 SHEET 3 OF 7 REV B	
		CUSTOMER DRAWING		

THIS DRAWING IS UNPUBLISHED. RELEASED FOR PUBLICATION 20
 © COPYRIGHT 20 BY - ALL RIGHTS RESERVED.

REVISIONS				
P	LTR	DESCRIPTION	DATE	APVD
-	-	SEE SHEET 1	-	-

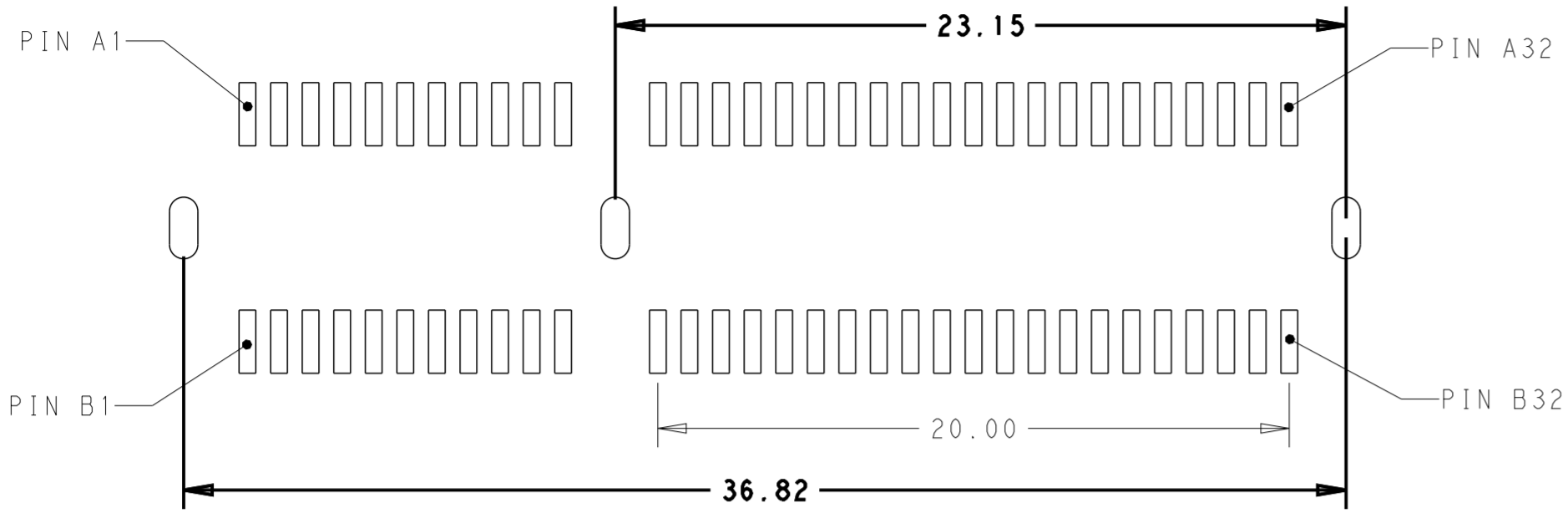

RECOMENDED PCB LAYOUT (64POS)
 OTHER DIMENSIONS SAME AS 36POS
 SCALE 5:1

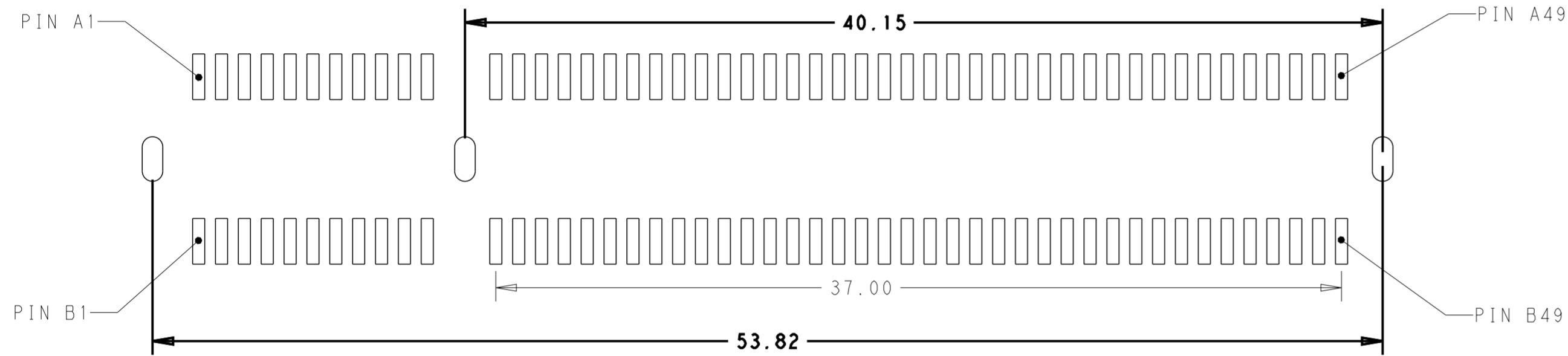

RECOMENDED PCB LAYOUT (98POS)
 OTHER DIMENSIONS SAME AS 36POS
 SCALE 5:1

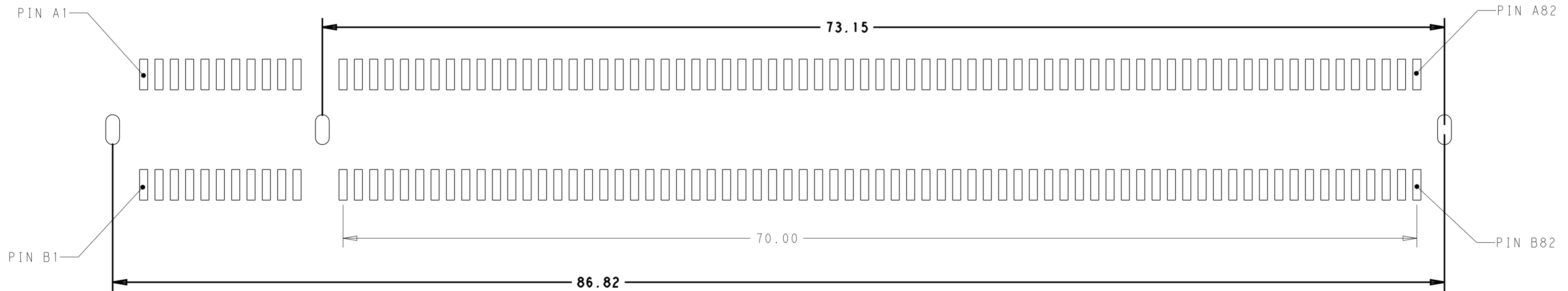

RECOMENDED PCB LAYOUT (164POS)
 OTHER DIMENSIONS SAME AS 36POS
 SCALE 5:1

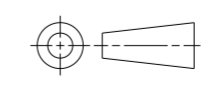
THIS DRAWING IS A CONTROLLED DOCUMENT.		DWN 13SEP2021 SANDERS, YAN	 TE Connectivity	
		CHK 13SEP2021 MIKE, CHEN		
		APVD 13SEP2021 HOPE, LU	NAME PCI EXPRESS CARD EDGE CONNECTOR GEN5, 2.76 SOLDER TAB, WITHOUT RIDGE	
DIMENSIONS: mm 		PRODUCT SPEC 108-160247	RESTRICTED TO -	
TOLERANCES UNLESS OTHERWISE SPECIFIED: 0 PLC ±- 1 PLC ±0.3 2 PLC ±0.20 3 PLC ±0.050 4 PLC ±- ANGLES ±- FINISH -		APPLICATION SPEC -	SIZE A2	CAGE CODE 00779
MATERIAL -		WEIGHT -	DRAWING NO. C-2399941	SCALE 6:1
		CUSTOMER DRAWING	SHEET 4 OF 7	REV B

THIS DRAWING IS UNPUBLISHED. RELEASED FOR PUBLICATION 20
 © COPYRIGHT 20 BY - ALL RIGHTS RESERVED.

REVISIONS					
P	LTR	DESCRIPTION	DATE	DWN	APVD
-	-	SEE SHEET 1	-	-	-

FRONT VIEW

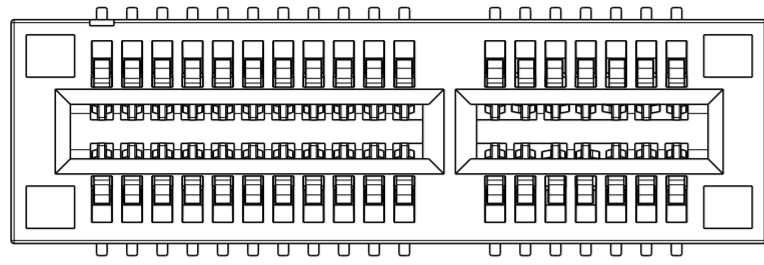

36POS AS SHOWN
SCALE 4:1

FRONT VIEW

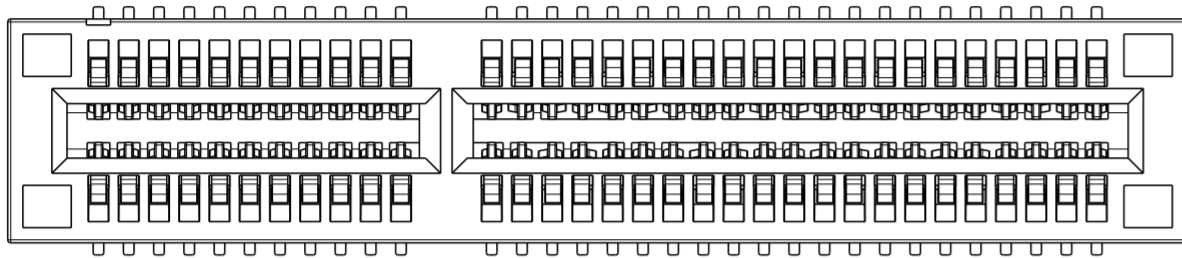

64POS AS SHOWN
SCALE 4:1

FRONT VIEW

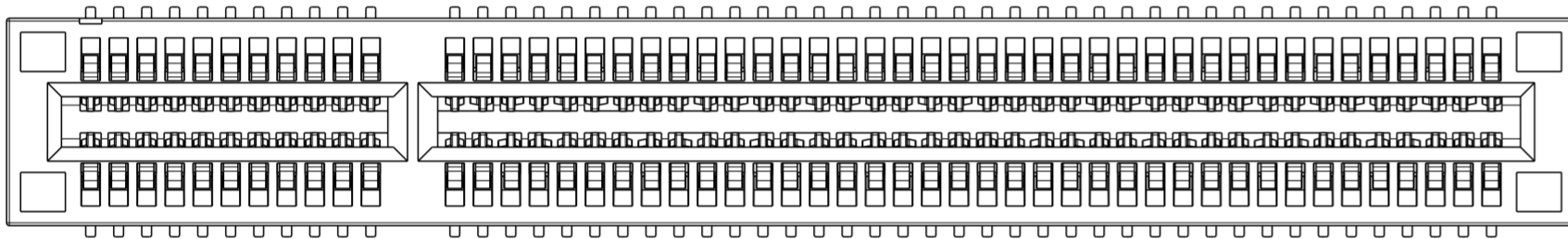

98POS AS SHOWN
SCALE 4:1

FRONT VIEW

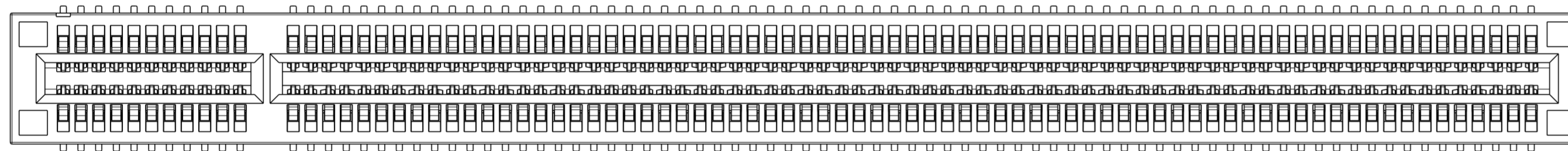

164POS AS SHOWN
SCALE 4:1

FRONT VIEW

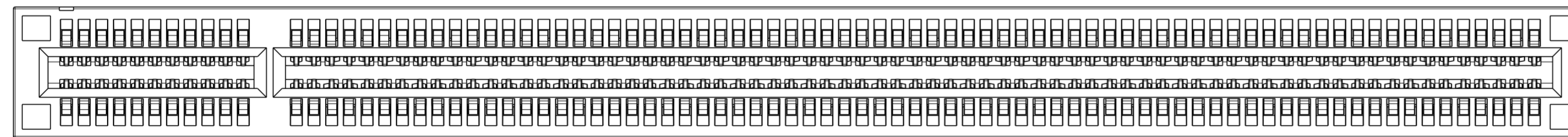

9-2399941-8 AS SHOWN
SCALE 4:1

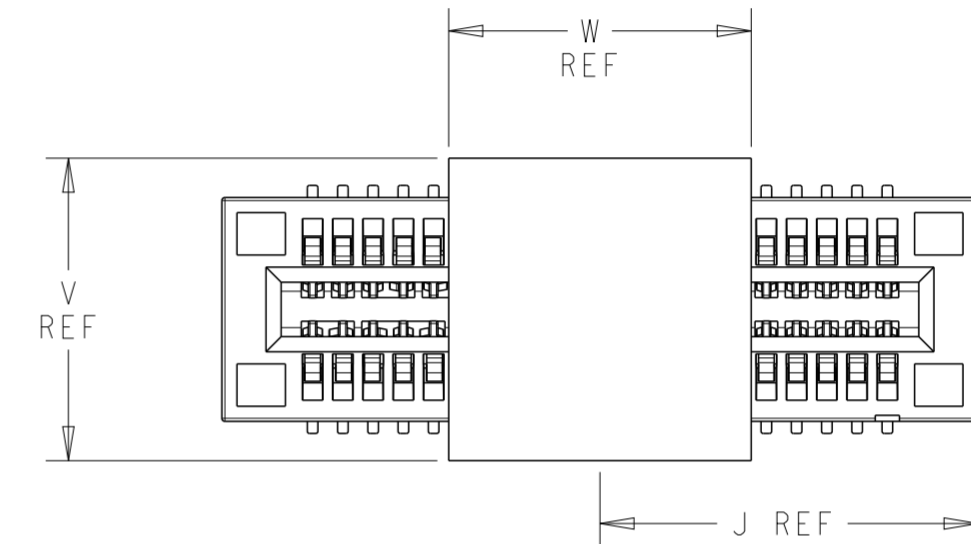

MYLAR SIZE
SCALE 4:1

THIS DRAWING IS A CONTROLLED DOCUMENT.		DWN 13SEP2021 SANDERS, YAN	TE Connectivity	
		CHK 13SEP2021 MIKE, CHEN		
DIMENSIONS:		APVD 13SEP2021 HOPE, LU	NAME PCI EXPRESS CARD EDGE CONNECTOR GEN5, 2.76 SOLDER TAB, WITHOUT RIDGE	
mm		PRODUCT SPEC 108-160247	SIZE CAGE CODE DRAWING NO RESTRICTED TO	
		APPLICATION SPEC -	A200779 C-2399941 -	
MATERIAL		WEIGHT	SCALE 6:1 SHEET 5 OF 7 REV B	
-		-	CUSTOMER DRAWING	
-		-		

THIS DRAWING IS UNPUBLISHED. RELEASED FOR PUBLICATION 20
 © COPYRIGHT 20 BY - ALL RIGHTS RESERVED.

REVISIONS				
P	LTR	DESCRIPTION	DATE	APVD
-	-	SEE SHEET 1	-	-

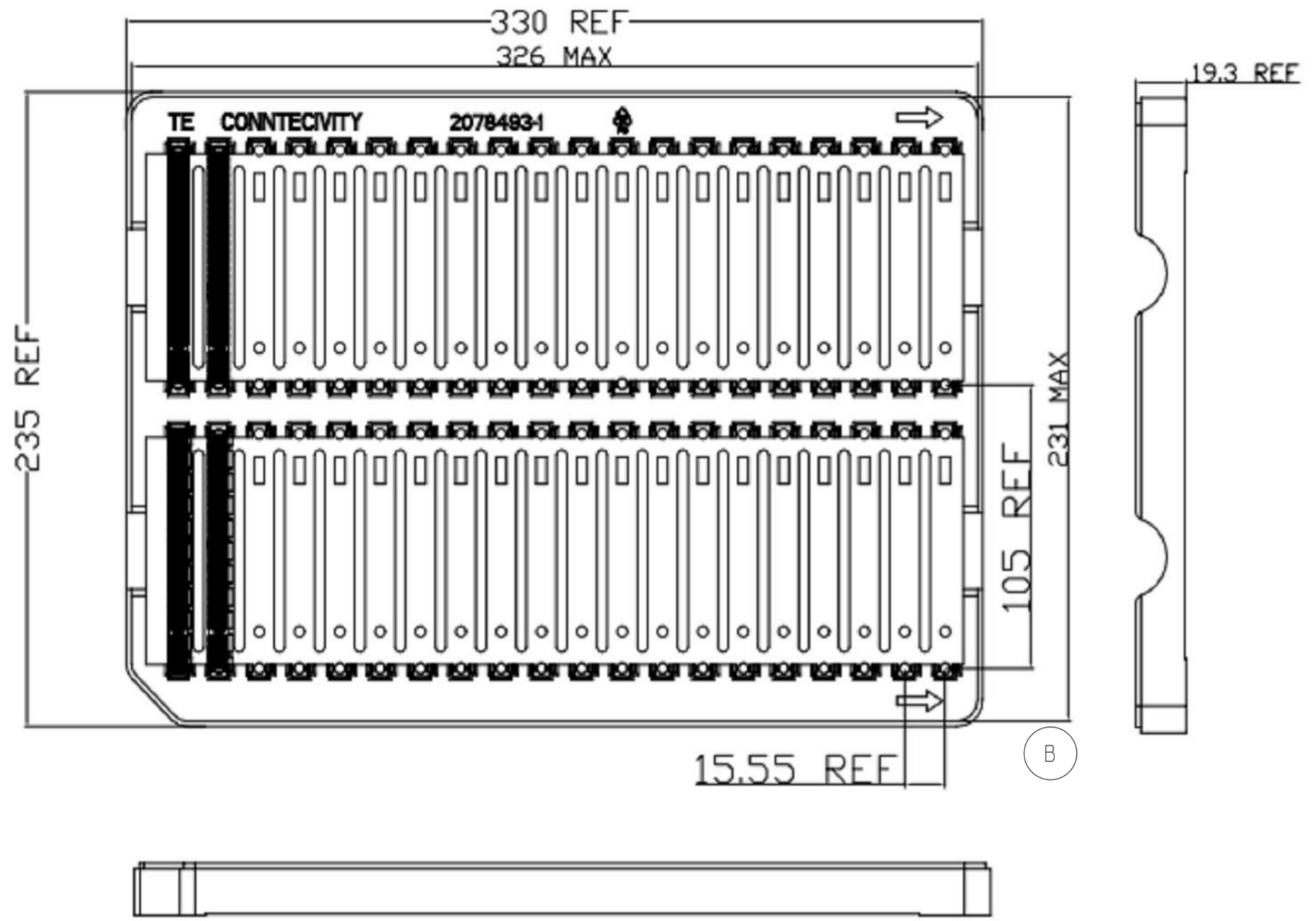

HARD TRAY: 164POS
 SCALE 1:2

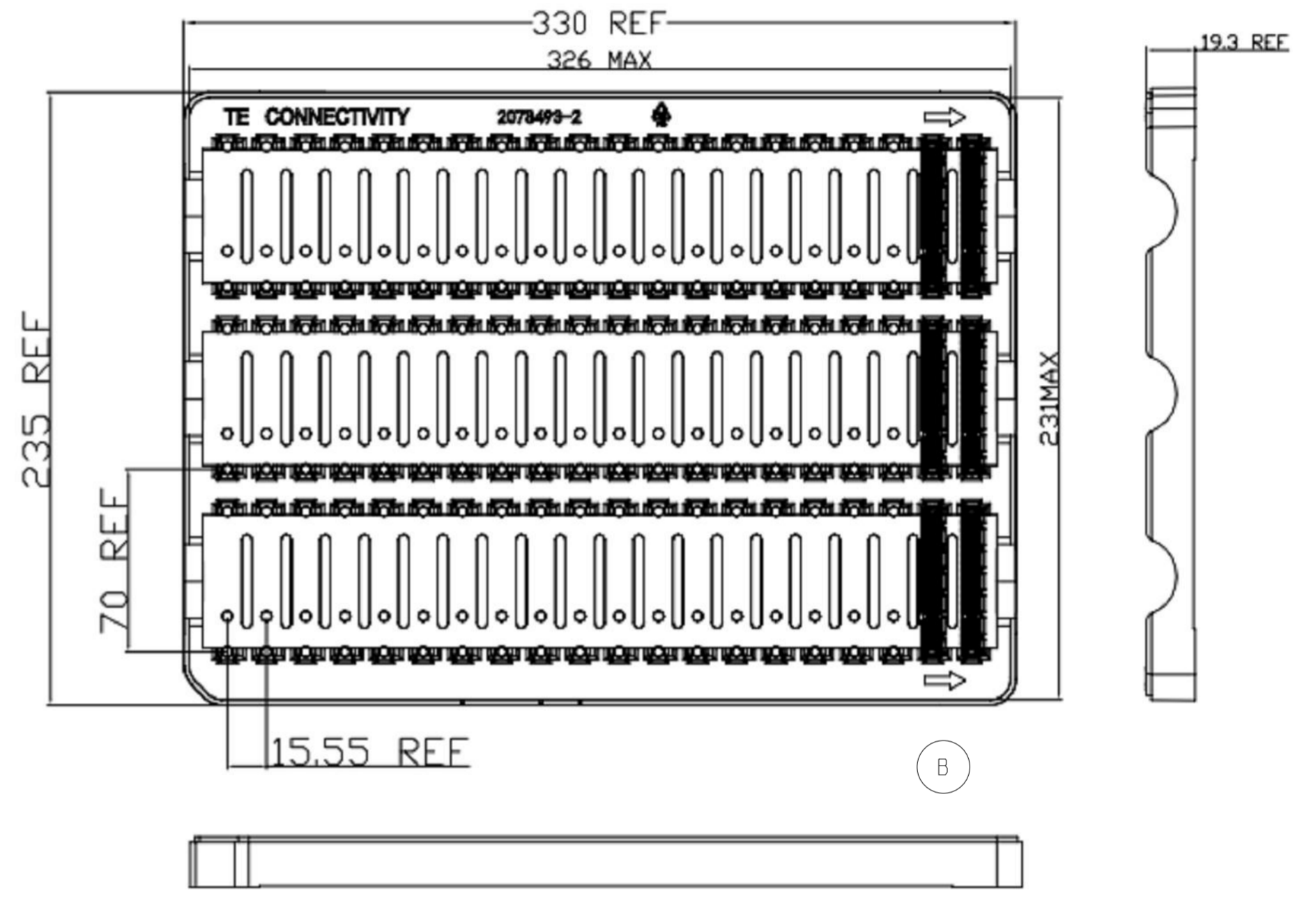

HARD TRAY: 98POS
 SCALE 1:2

THIS DRAWING IS A CONTROLLED DOCUMENT.		DWN SANDERS, YAN 13SEP2021	 TE Connectivity	
DIMENSIONS: mm		CHK MIKE, CHEN 13SEP2021		
TOLERANCES UNLESS OTHERWISE SPECIFIED:		APVD HOPE, LU 13SEP2021	NAME PCI EXPRESS CARD EDGE CONNECTOR GEN5, 2.76 SOLDER TAB, WITHOUT RIDGE	
0 PLC ±	1 PLC ±0.3	PRODUCT SPEC 108-160247	SIZE A2	CAGE CODE 00779
2 PLC ±0.20	3 PLC ±0.050	APPLICATION SPEC -	DRAWING NO C-2399941	RESTRICTED TO -
4 PLC ±	ANGLES ±	WEIGHT -	SCALE 6:1	SHEET 6 OF 7
MATERIAL -	FINISH -	CUSTOMER DRAWING	REV B	

THIS DRAWING IS UNPUBLISHED. RELEASED FOR PUBLICATION 20
 © COPYRIGHT 20 BY - ALL RIGHTS RESERVED.

REVISIONS					
P	LTR	DESCRIPTION	DATE	DWN	APVD
-	-	SEE SHEET 1	-	-	-

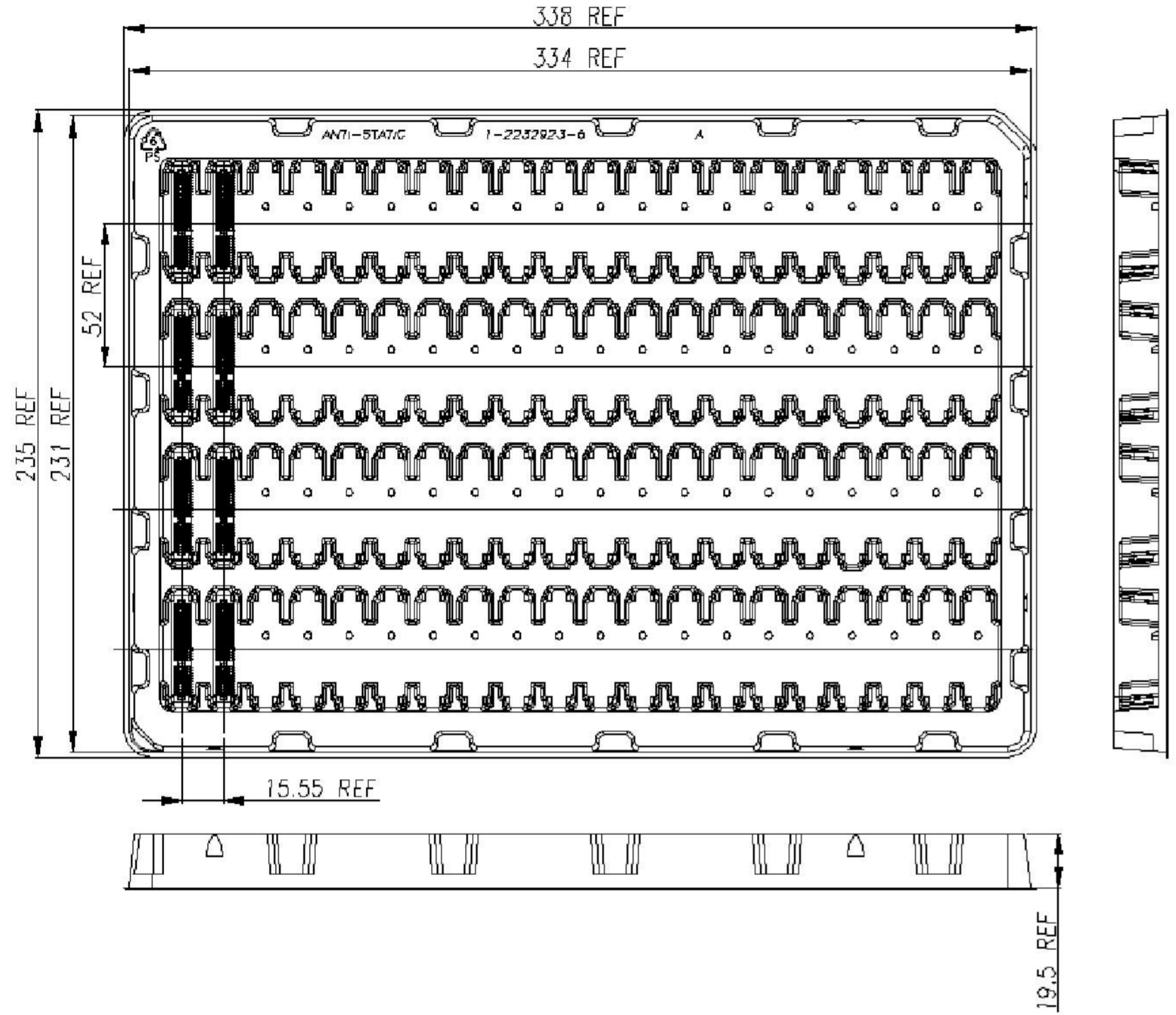

SOFT TRAY: 64POS
 SCALE 1:2

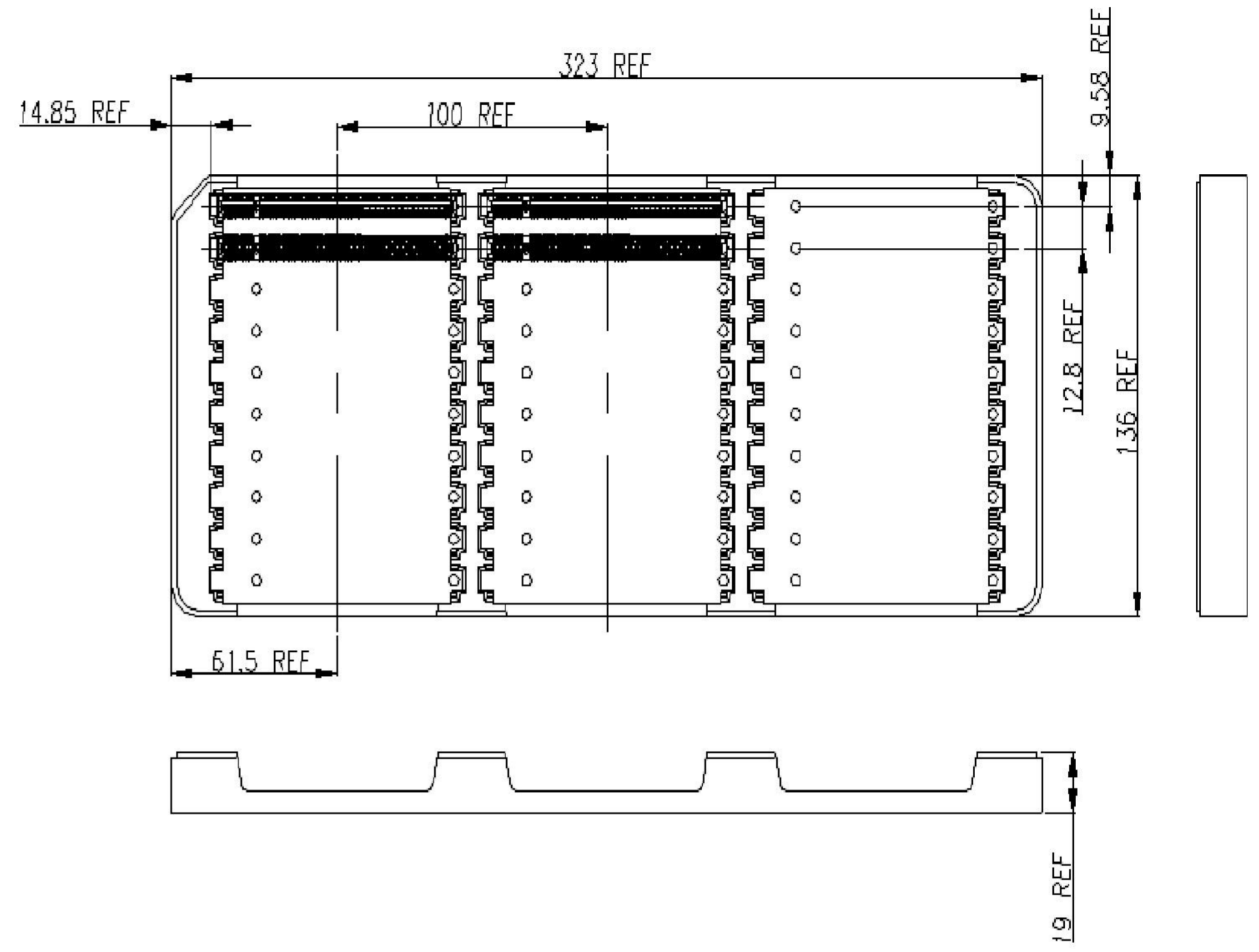

HARD TRAY: FOR 6-2399941-8/9-2399941-8/8-2399941-8 (164POS)
 SCALE 1:2

THIS DRAWING IS A CONTROLLED DOCUMENT.		DWN 13SEP2021 SANDERS, YAN	 TE Connectivity															
DIMENSIONS: mm		CHK 13SEP2021 MIKE, CHEN																
TOLERANCES UNLESS OTHERWISE SPECIFIED:		APVD 13SEP2021 HOPE, LU	NAME PCI EXPRESS CARD EDGE CONNECTOR GEN5, 2.76 SOLDER TAB, WITHOUT RIDGE															
<table border="1"> <tr> <td>0 PLC</td> <td>±</td> </tr> <tr> <td>1 PLC</td> <td>±0.3</td> </tr> <tr> <td>2 PLC</td> <td>±0.20</td> </tr> <tr> <td>3 PLC</td> <td>±0.050</td> </tr> <tr> <td>4 PLC</td> <td>±</td> </tr> <tr> <td>ANGLES</td> <td>±</td> </tr> <tr> <td>FINISH</td> <td>±</td> </tr> </table>		0 PLC	±	1 PLC	±0.3	2 PLC	±0.20	3 PLC	±0.050	4 PLC	±	ANGLES	±	FINISH	±	PRODUCT SPEC 108-160247	SIZE A2	
0 PLC	±																	
1 PLC	±0.3																	
2 PLC	±0.20																	
3 PLC	±0.050																	
4 PLC	±																	
ANGLES	±																	
FINISH	±																	
MATERIAL		APPLICATION SPEC	CAGE CODE 200779	DRAWING NO C-2399941														
-		WEIGHT	RESTRICTED TO															
-		CUSTOMER DRAWING	SCALE 6:1	SHEET 7 OF 7														
			REV B															