

P	LTR	DESCRIPTION	DATE	DWN	APVD
	A	RELEASED	25OCT2022	JS	KT

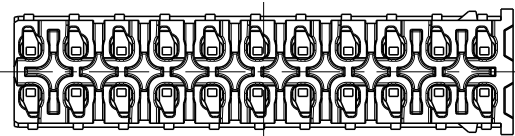
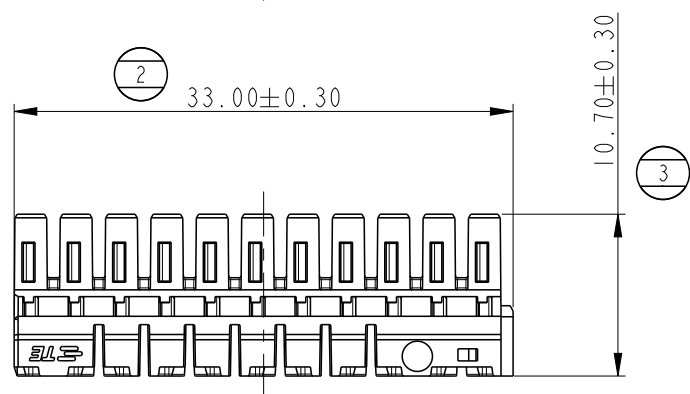
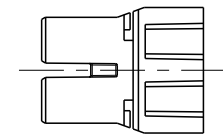
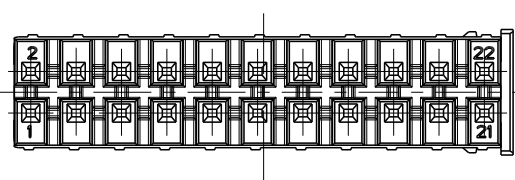
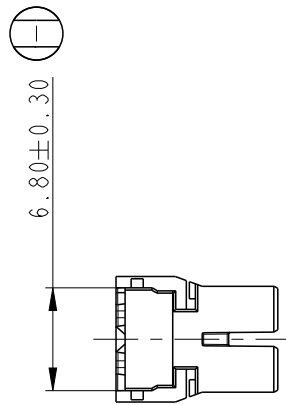
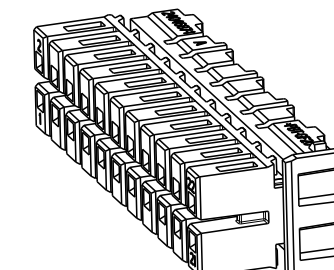
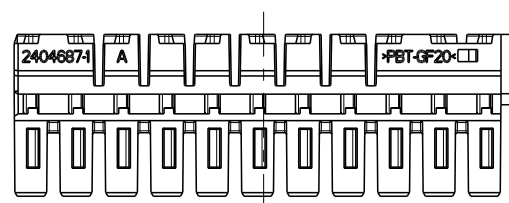

NOTE

1. GENERAL TOLERANCE : ±0.3
2. APPLICABLE COVER HSG : 2404685
3. FITTING CONTACTS : PICO MQS 2320281
4. COUNTERPART / INTERFACE : 208-18102
5. BURK PACKAGED

NO	PART NUMBER	PART NAME	MATERIAL	COLOR	QTY
1	2404687-1	PICO 22P REC HSG	PBT-GF20	BLACK	1

THIS DRAWING IS A CONTROLLED DOCUMENT.		DWN JS KIM			
DIMENSIONS: mm		CHK YH KIM			
TOLERANCES UNLESS OTHERWISE SPECIFIED:		APVD KT JUNG	NAME PICO 22P REC HSG		
0 PLC ± 1 PLC ± 2 PLC ± 3 PLC ± 4 PLC ± ANGLES ± FINISH -		PRODUCT SPEC 108-94648	-		
MATERIAL SEE TABLE		APPLICATION SPEC 114-94520	SIZE A3	CAGE CODE 00779	DRAWING NO C-2404687
		WEIGHT -	RESTRICTED TO -		
CUSTOMER DRAWING			SCALE 2:1	SHEET 1 OF 1	REV A