

4 3 2 1

THIS DRAWING IS UNPUBLISHED. RELEASED FOR PUBLICATION
 © COPYRIGHT - By - ALL RIGHTS RESERVED.

LOC		DIST		REVISIONS			
P	LTR	DESCRIPTION		DATE	DWN	APVD	
	G	CHANGE BASE MATERIAL TO PBT		ECN-21-111227	15-JUL-21	XRL	K.T

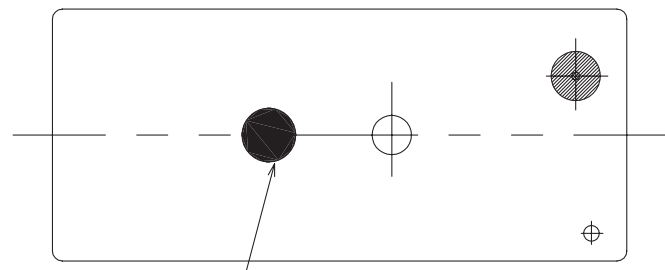

DOT MARK: PURPLE

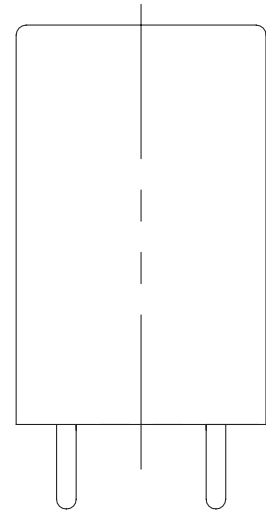
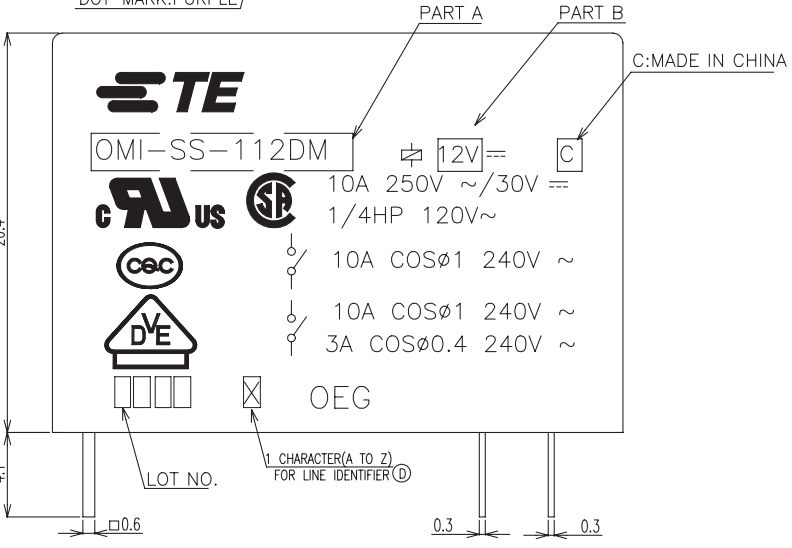

CONNECTION DIAGRAM (BOTTOM VIEW)

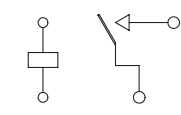

DRILLING DIAGRAM (2/1) (BOTTOM VIEW)

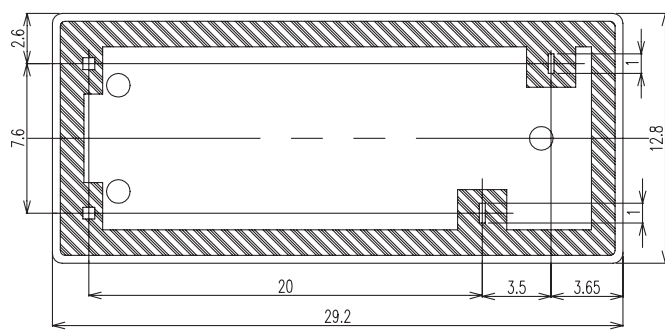
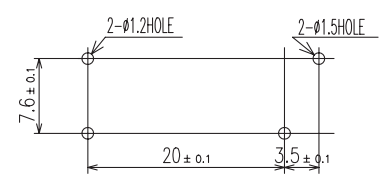

THIS DRAWING IS A CONTROLLED DOCUMENT.		DWN H.SASAKI	TE Connectivity OMI-1M,394 CUSTOMER DRAWING		
DIMENSIONS: mm		CHK -			
TOLERANCES UNLESS OTHERWISE SPECIFIED:		APVD Y.OIKAWA	RESTRICTED TO		
0 PLC ±- 1 PLC ±- 2 PLC ±- 3 PLC ±- 4 PLC ±- ANGLES ±- FINISH		PRODUCT SPEC A.NAGAI	SIZE A3	CAGE CODE 00779	DRAWING NO C=3-1440000-9
MATERIAL		APPLICATION SPEC -	WEIGHT -	SCALE 1:1	SHEET 1 OF 2
CUSTOMER DRAWING			REV G		

4

3

2

1

THIS DRAWING IS UNPUBLISHED. RELEASED FOR PUBLICATION
 © COPYRIGHT - By - ALL RIGHTS RESERVED.

LOC	DIST	REVISIONS					
HB	-	P	LTR	DESCRIPTION	DATE	DWN	APVD

NOTES:
 1.-SH- : WASHABLE TYPE
 2.LOT NO. SYSTEM AS FOLLOWING:

0701 WEEK
 YEAR

3.GENERAL TOLERANCE AS FOLLOWING:

TOLERANCE	
MAX .1mm	±0.1
1mm~MAX.3mm	±0.2
3mm MIN.	±0.3

4.FOR THE TIN-PLATING OF THE PINS:
 +0.1mm FOR WIDTH,THICKNESS AND DIAMETER.
 +0.5mm FOR LENGTH.

TE PART NO	DESCRIPTION	PART B	PART A
2071438-1	OMI-SH-112LM	12V	OMI-SH-112LM
4-1440000-4	OMI-SH-124LM	24V	OMI-SH-124LM
4-1440000-1	OMI-SH-112LM	12V	OMI-SH-112LM
3-1440000-9	OMI-SH-112DM	12V	OMI-SH-112DM

RELAY TYPE

RELAY TYPE	UV RESIN	UV SEAL	ITEM	
	EPOXY RESIN	SEAL	15	
UL94 V-0	PBT (F)	CASE	14	
CLASS E	UEW	MAGNETIC WIRE	13	
UL94 V-0	PBT (G)	BASE	12	
UL94 V-0	PBT	BOBBIN	11	
	SOLDER DIP	CP WIRE	COIL TERMINAL	10
UL94 V-0	PPS	CARD	9	
	Ag ALLOY	MOVABLE CONTACT	8	
	Ag ALLOY	STATIONARY CONTACT	7	
	Cu ALLOY	HINGE SPRING	6	
	SOLDER DIP	Cu ALLOY	STATIONARY TERMINAL	5
	SOLDER DIP	Cu ALLOY	MOVABLE SPRING	4
	STEEL	CORE	3	
	STEEL	ARMATURE	2	
	STEEL	YOKE	1	
INCOMBUSTIBILITY	TREATMENT	MATERIAL	DESCRIPTION	ITEM

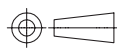
THIS DRAWING IS A CONTROLLED DOCUMENT.		DWN H.SASAKI	 TE Connectivity		
DIMENSIONS: mm		CHK -			
		APVD Y.OIKAWA	NAME		
TOLERANCES UNLESS OTHERWISE SPECIFIED:		PRODUCT SPEC A.NAGAI	OMI-1M,394 CUSTOMER DRAWING		
0 PLC ± -		APPLICATION SPEC -	SIZE A3	CAGE CODE 00779	DRAWING NO C=3-1440000-9
1 PLC ± -		WEIGHT -	RESTRICTED TO		
2 PLC ± -		CUSTOMER DRAWING			
3 PLC ± -		SCALE 1:1		SHEET 2 OF 2	
4 PLC ± -		REV G			
ANGLES ± -					
FINISH					