

THIS DRAWING IS UNPUBLISHED.

RELEASED FOR PUBLICATION

© COPYRIGHT -

ALL RIGHTS RESERVED.

LOC H DIST -

REVISIONS

P	LTR	DESCRIPTION	DATE	DWN	APVD
H3		APPLICATION SPECIFICATION NUMBER ADDED	24JUL2013	KJK	RP
H4		BLISTER MATERIAL CHANGE FOR 16POS	05MAY2015	NV	PS

REFERENCE MATING INTERFACE PATTERN:  
1,27 STAGGERED PITCH x 1,5 ROW-DISTANCE.

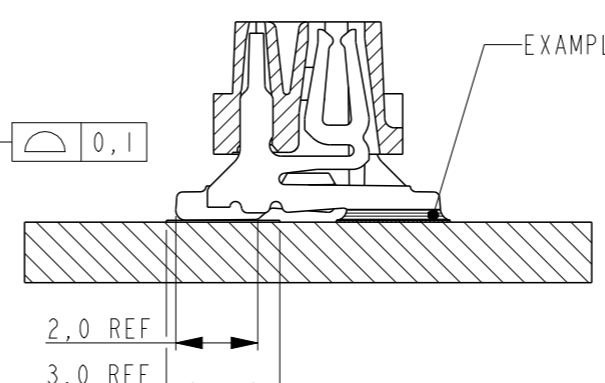
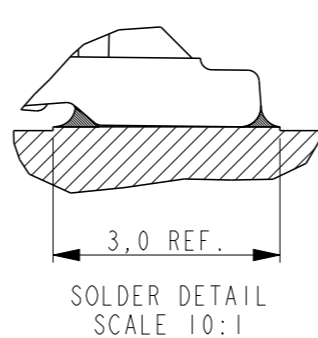
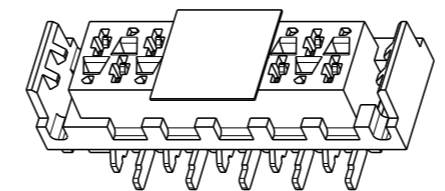
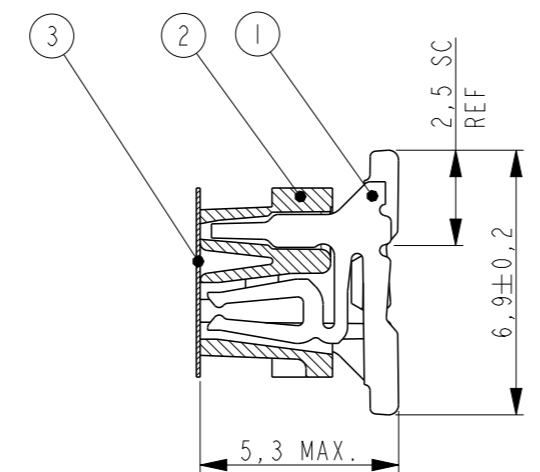
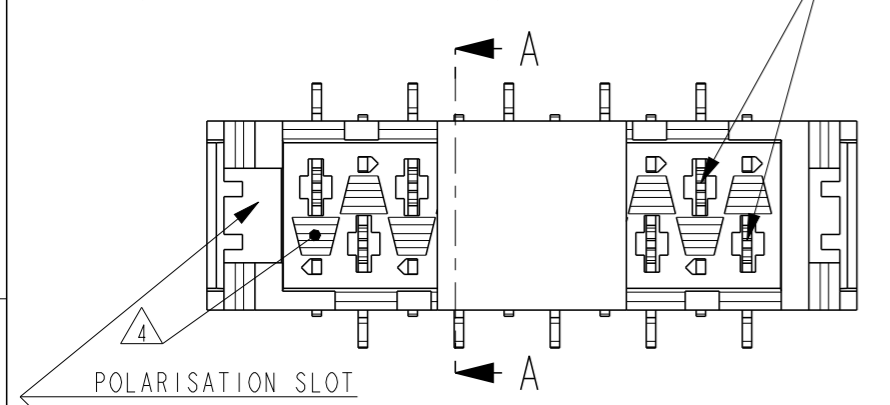

△ PART NUMBER VAC. TAPE.	PART NUMBER <sup>3</sup>	PART REV	NR. OF POS. "n"	"A"	"B" MAX.
7-338069-4	0-338069-4	K	4	3,81	9,7
7-338069-6	0-338069-6	K	6	6,35	12,2
7-338069-8	0-338069-8	K	8	8,89	14,7
8-338069-0	1-338069-0	K	10	11,43	17,3
8-338069-2	1-338069-2	K	12	13,97	19,8
8-338069-4	1-338069-4	K	14	16,51	22,4
8-338069-6	1-338069-6	L	16	19,05	24,9
8-338069-8	1-338069-8	K	18	21,59	27,4
9-338069-0	2-338069-0	K	20	24,13	30,0
9-338069-4	2-338069-4	K	24	29,21	35,0

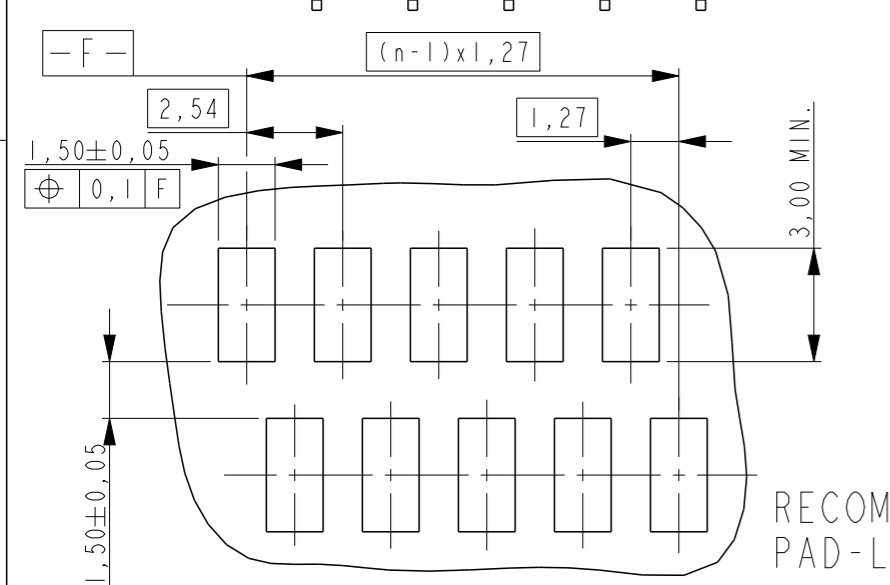
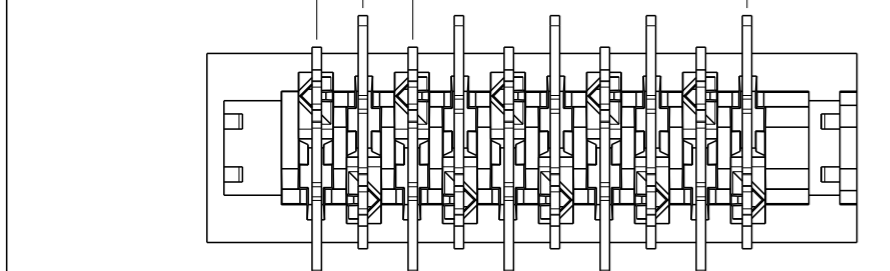
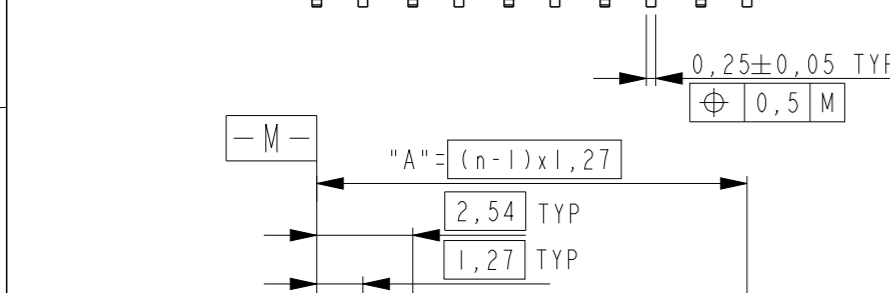
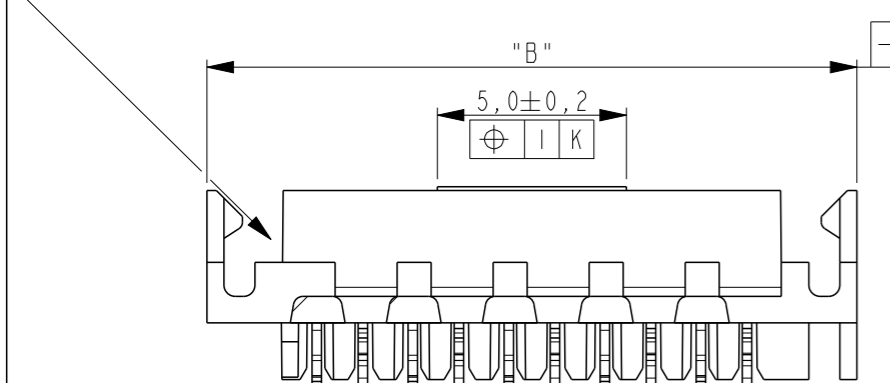

NOTES:

- △ TAPE FOR VACUUM P&P ONLY FOR DASH NUMBERS 7- /8- /9-
- 2 FOR PACKAGING SEE SHEET 2 AND 3
- △ 3 WITHOUT VACUUM TAPE.
- △ 4 CORING-OUTS FOR MANUFACTURING PURPOSE ONLY. SHAPE MAY VARY, BUT IS NOT FUNCTIONAL FOR THE APPLICATION.
- 5 SHOWN IS A 10 POSITION CONNECTOR.

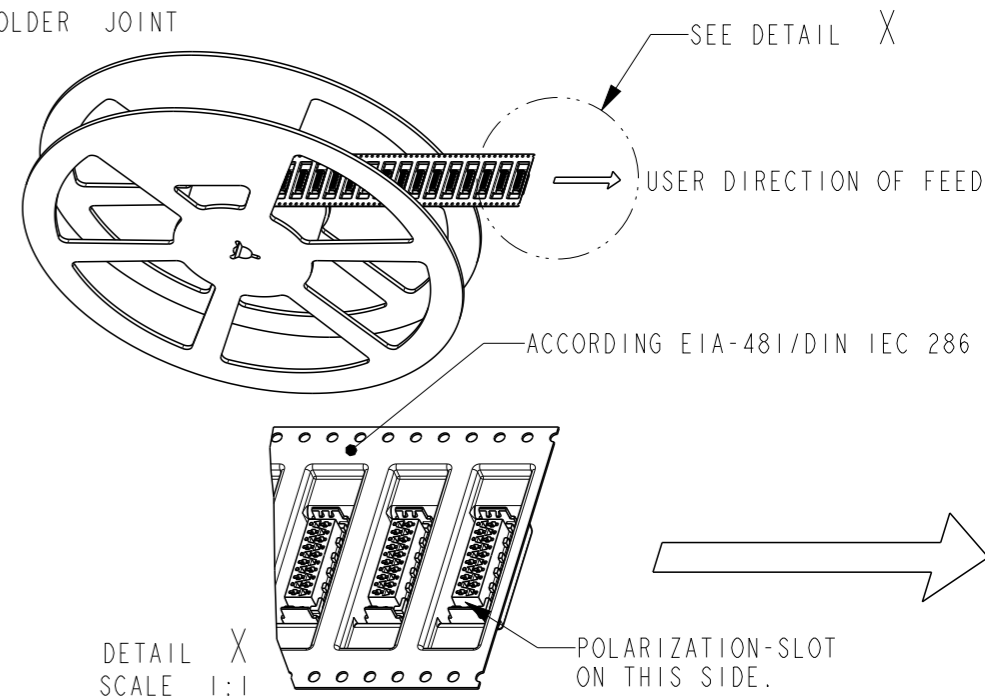

Item no.	Description	Material	Finish
3	PICK & PLACE TAPE	KAPTON	AMBER TRANSPARENT
2	FEMALE HOUSING	POLYAMIDE 4/6,GF	RED
1	FEMALE CONTACT	PHOSPHOR BRONZE	TIN OVER NICKEL

THIS DRAWING IS A CONTROLLED DOCUMENT.	
DIMENSIONS: mm	TOLERANCES UNLESS OTHERWISE SPECIFIED:
0 PLC ±-	1 PLC ±-
1 PLC ±-	2 PLC ±-
2 PLC ±-	3 PLC ±-
3 PLC ±-	4 PLC ±-
4 PLC ±-	ANGLES ±-
MATERIAL SEE TABLE	FINISH SEE TABLE

DWN M. Gosselink IDECO1

CHK -

APVD -

PRODUCT SPEC 108-19052

APPLICATION SPEC 114-13318

WEIGHT -

CUSTOMER DRAWING

**STE** TE Connectivity

CONNECTOR, FEMALE-ON-BOARD TOP-ENTRY, SMD, WITH LATCHES, Micro-MaTch

SIZE A3 CAGE CODE 00779 DRAWING NO C-338069 RESTRICTED TO -

SCALE 5:1 SHEET 1 OF 3 REV H4

THIS DRAWING IS UNPUBLISHED.

RELEASED FOR PUBLICATION

© COPYRIGHT -

ALL RIGHTS RESERVED.

LOC H DIST -

REVISIONS

P	LTR	DESCRIPTION	DATE	DWN	APVD
-	-	SEE SHEET 1	-	-	-

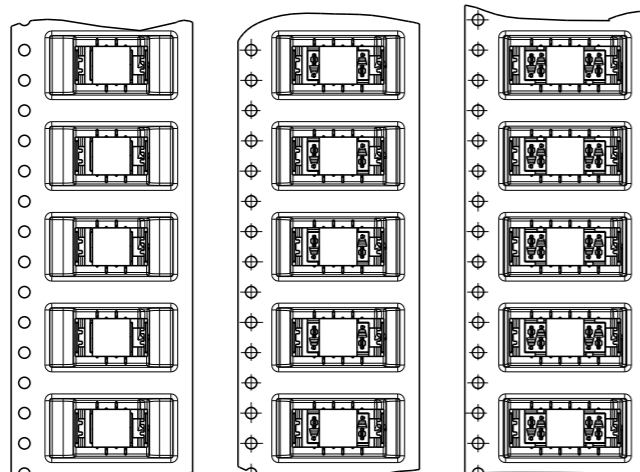

7-338069-4    7-338069-6    7-338069-8

4 POSITIONS    6 POSITIONS    8 POSITIONS

338069-4    338069-6    338069-8

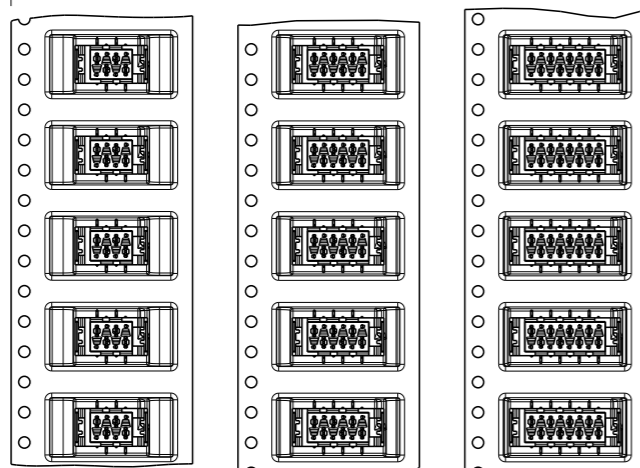

24mm wide tape    24mm wide tape    24mm wide tape

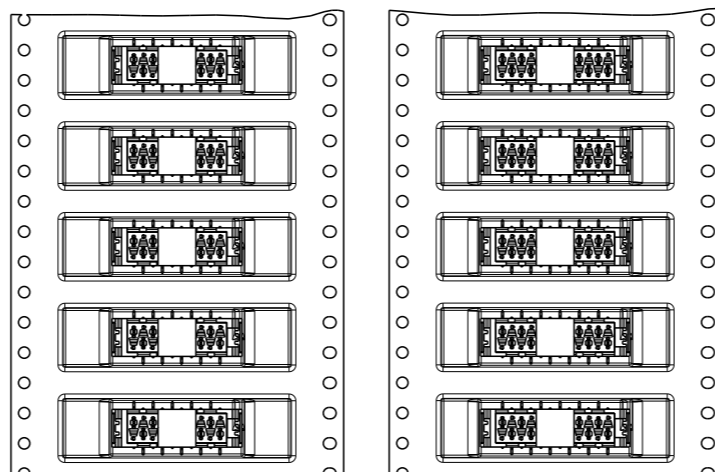

8-338069-0    8-338069-2

10 POSITIONS    12 POSITIONS

1-338069-0    1-338069-2

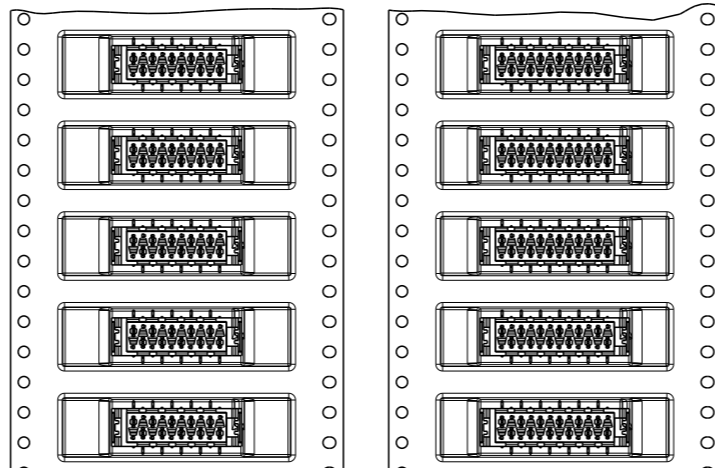

44mm wide tape    44mm wide tape

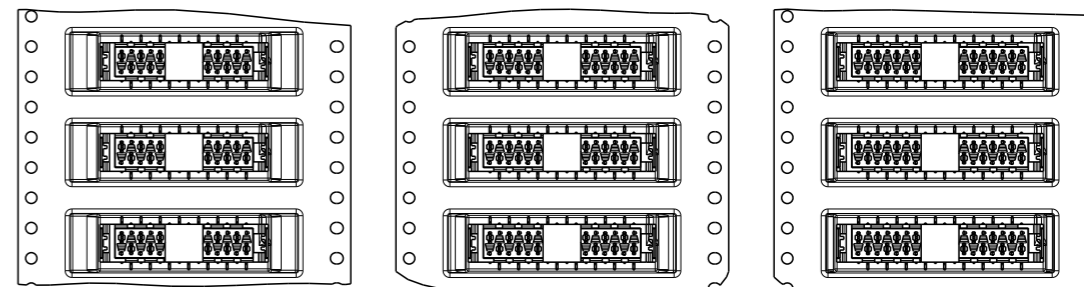

8-338069-4    8-338069-6    8-338069-8

14 POSITIONS    16 POSITIONS    18 POSITIONS

1-338069-4    1-338069-6    1-338069-8

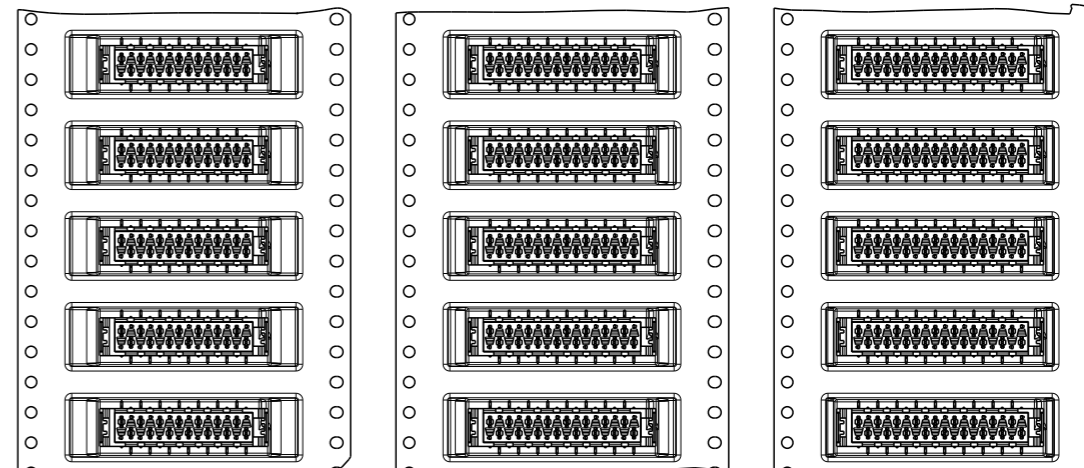

44mm wide tape    44mm wide tape    44mm wide tape

THIS DRAWING IS A CONTROLLED DOCUMENT.

DWN M.Gosselink IIDE01

CHK -

APVD -

PRODUCT SPEC 108-19052

APPLICATION SPEC 114-13318

WEIGHT -

CUSTOMER DRAWING



NAME CONNECTOR, FEMALE-ON-BOARD TOP-ENTRY, SMD, WITH LATCHES, Micro-MaTch

SIZE A3 CAGE CODE 00779 DRAWING NO C-338069 RESTRICTED TO -

SCALE 5:1 SHEET 2 OF 3 REV H4

DIMENSIONS: mm

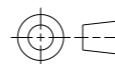

TOLERANCES UNLESS OTHERWISE SPECIFIED:

- 0 PLC ±-
- 1 PLC ±-
- 2 PLC ±-
- 3 PLC ±-
- 4 PLC ±-
- ANGLES ±-
- FINISH -

MATERIAL -

THIS DRAWING IS UNPUBLISHED.

RELEASED FOR PUBLICATION

© COPYRIGHT -

ALL RIGHTS RESERVED.

LOC

DIST

REVISIONS

H

-

P

LTR

DESCRIPTION

DATE

DWN

APVD

SEE SHEET 1

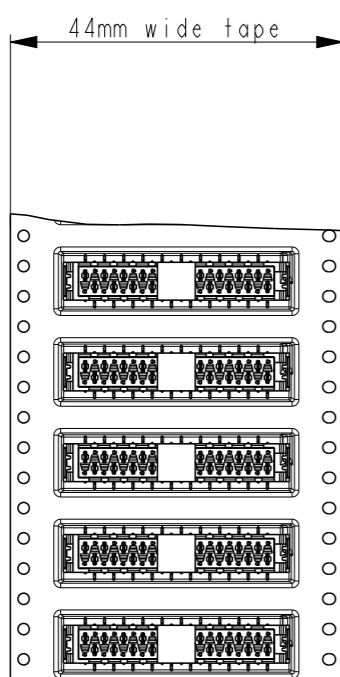

9-338069-0  
20 POSITIONS  
2-338069-0

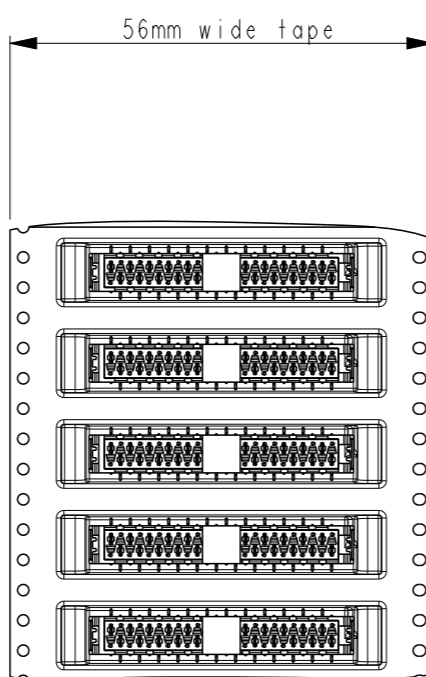
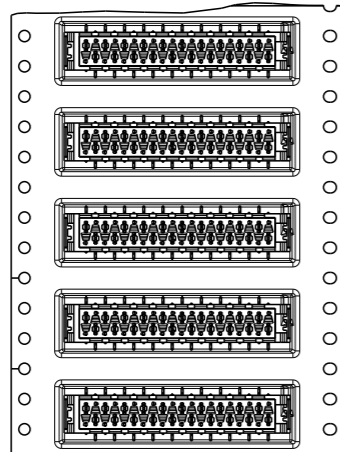

9-338069-4  
24 POSITIONS  
2-338069-4

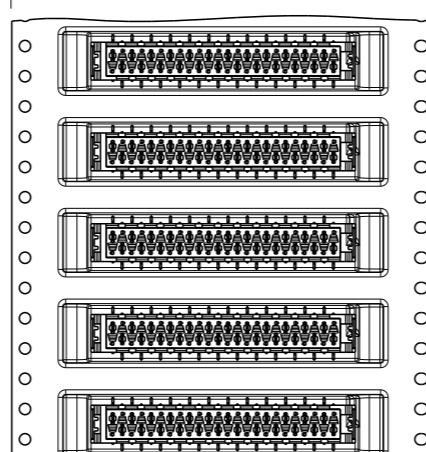

THIS DRAWING IS A CONTROLLED DOCUMENT.

DIMENSIONS:  
mm

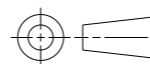

TOLERANCES UNLESS OTHERWISE SPECIFIED:

- 0 PLC ±-
- 1 PLC ±-
- 2 PLC ±-
- 3 PLC ±-
- 4 PLC ±-
- ANGLES ±-

MATERIAL

FINISH

DWN M. Gosselink IIDECO1

CHK -

APVD -

PRODUCT SPEC

108-19052

APPLICATION SPEC

114-13318

WEIGHT

-



TE Connectivity

NAME

CONNECTOR,  
FEMALE-ON-BOARD TOP-ENTRY,  
SMD, WITH LATCHES, Micro-MaTch

SIZE

CAGE CODE

DRAWING NO

RESTRICTED TO

A3

00779

C-338069

-

CUSTOMER DRAWING

SCALE 5:1

SHEET 3 OF 3

REV H4