

815 Series High-Density Bayonet-Locking Connectors

Bulletin 118

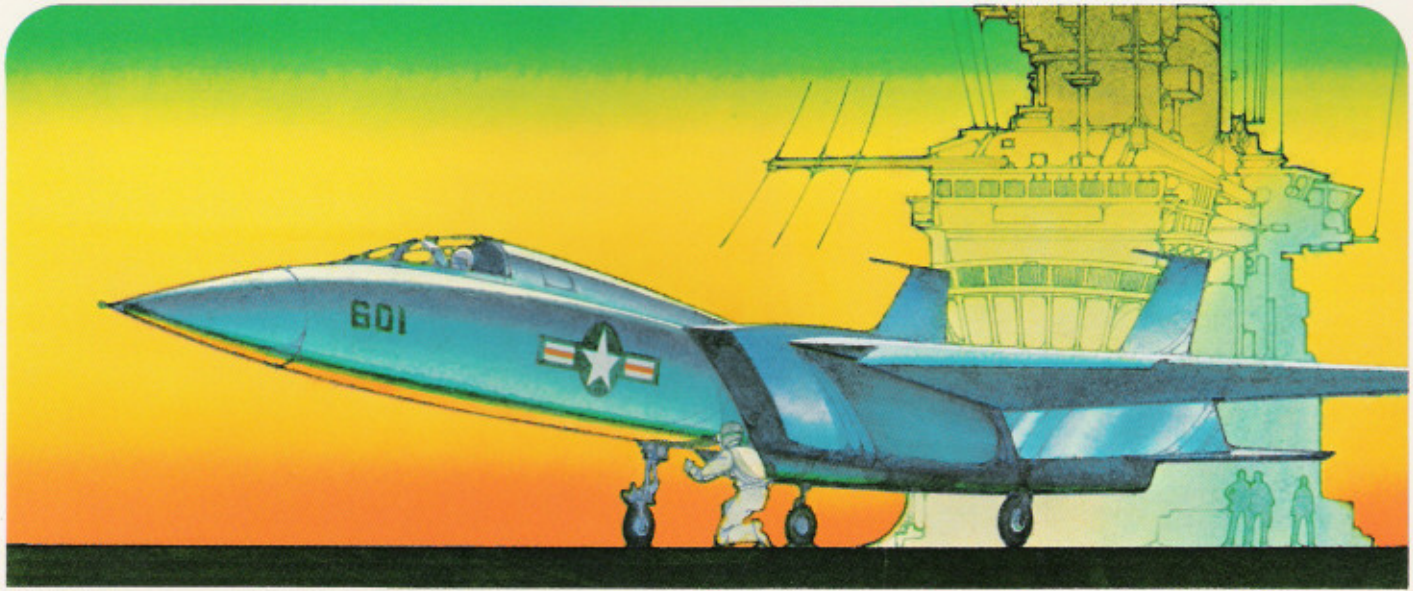

MIL-C-81511 MIL
81511 MIL-C-8151
IL-C-81511 MIL-C
511 MIL-C-81511

DEUTSCH

INTRODUCTION

Individual Contact Release (ICR) is a state-of-the-art advancement in the Deutsch Company's MIL-C-81511 (Series 3 and 4) connectors. The ICR system permits each crimp-type contact to be individually inserted, released and extracted from the rear of the connector in the coupled or uncoupled position. And, during contact insertion there is a positive "feel" when the contact reaches the locked position.

Featuring one of the industry's lowest contact insertion forces . . . these Deutsch Connectors provide several additional major advantages over earlier MIL-C-81511 designs:

- Prevention of inadvertent contact release
- Simplified assembly procedures
- Reduced assembly and rework costs
- Higher temperature resistance
- Up to 30% less weight
- Lower profile
- More effective sealing
- Up to 10 lbs.-in. lower mating forces

The Deutsch ICR system incorporates a non-metallic retention mechanism using high strength molded-in plastic retention fingers which are enclosed in rigid plastic cylinders so that it is impossible to overstress the system during contact insertion or extraction or by unauthorized probing. Elimination of metal retention clips saves weight and increases dielectric strength between contacts.

TABLE OF CONTENTS

Design Features	1
Shell Styles	2, 3
Insert Arrangements	4
Shell Polarization Keying Positions	5
Contact & Tooling Information	6, 7
Ordering Information	8, 9
Shielded Wire Contacts	10
Thermocouple Contacts	11
Assembly Instructions	12, 13
General Specifications	13

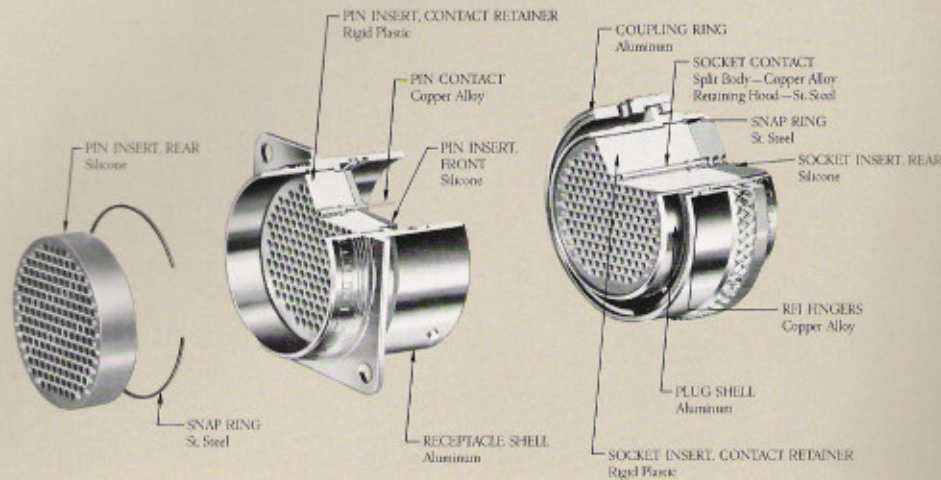

The low contact insertion force inherent in the ICR contact system can reduce assembly time tremendously because in most cases contacts can be inserted into the connector without the use of an insertion tool. Following this simple, single step procedure the contact is positively contained in the connector thereby preventing inadvertent contact release. The integrity of the ICR contact system has been verified by the contact retention system test requirements of MIL-C-81511.

Savings in rework costs can be achieved because contacts can be extracted without uncoupling the connector. This feature also does away with the need to insert tools from the connector front, thereby eliminating the possibility of damaging the critical interfacial sealing areas.

The fully bonded insert construction provides complete dielectric separation between contacts, eliminating the problem of air paths within the connector insert. The bonded insert construction also prevents "cross-pinning." Once the contact enters the contact cavity of the plastic insert, it cannot crossover into an adjacent cavity.

The Deutsch 815 Series connectors are intermateable and intermountable with earlier versions of MIL-C-81511. However, the shorter contacts of the Deutsch connector should not be intermixed with those of Series 1 and 2 connectors.

The scoop-proof feature of these connectors prevents damage to pin contacts when the mating half of the connector is accidentally wiped across the pin insert...as may occur in blind mating.

The 815 connectors are available in two versions: a long shell version (commonly called 100% scoop-proof) and a short shell version (commonly called 50% scoop-proof). The short shell version will prevent scooping damage providing the pin contacts are used in the receptacle half of the connector. The long shell version will prevent scooping damage with the pins used in either the plug or receptacle.

Contacts are normally inserted or extracted by a simple plastic tool. Only one tool is needed for a given contact size. Inexpensive and expendable, the tool will fail before damage occurs to the contact or the retention system.

Shell Styles

SQUARE FLANGE MOUNT RECEPTACLE

PLUG

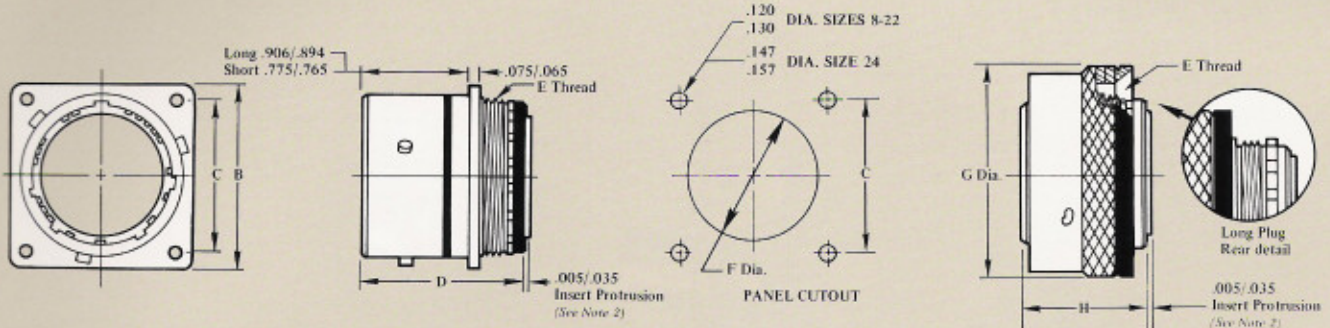

CABLE CONNECTING RECEPTACLE

SINGLE HOLE MOUNT RECEPTACLE

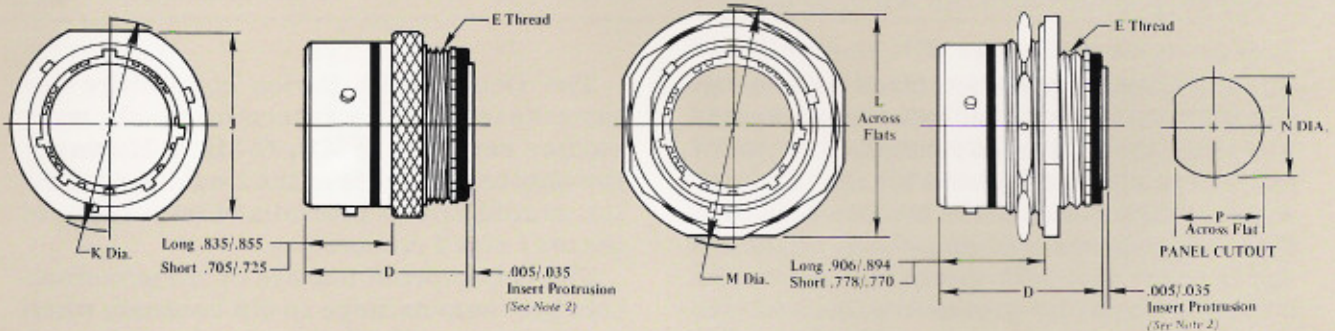

Shell Size	B ±.006	C ±.005	D ±.010		E Thread	F ±.005	G MAX.	H ±.010		J	K MAX.	L ±.010	M ±.010	N ±.005	P ±.005
			Long	Short				Long	Short						
8	.812	.594	1.308	1.177	1/2-28UNEF-2A	.635	.850	1.282	.937	.565/.553	.780	.979	1.062	.635	.605
10	.937	.719	1.308	1.177	5/8-28UN-2A	.760	.975	1.282	.937	.690/.678	.900	1.104	1.187	.760	.730
14	1.125	.906	1.308	1.177	3/4-28UN-2A	1.010	1.225	1.282	.937	.940/.928	1.150	1.391	1.500	1.010	.980
16	1.250	.969	1.308	1.177	1-28UN-2A	1.135	1.350	1.282	.937	1.066/1.054	1.280	1.516	1.625	1.135	1.105
18	1.343	1.062	1.308	1.177	1 1/8-28UN-2A	1.260	1.475	1.282	.937	1.190/1.178	1.400	1.641	1.735	1.260	1.230
*20	1.467	1.156	1.337	—	1 1/4-28UN-2A	1.385	1.624	1.311	—	1.315/1.305	1.525	1.766	1.860	1.385	1.355
*22	1.562	1.250	1.337	—	1 3/8-28UN-2A	1.510	1.749	1.311	—	1.440/1.430	1.650	1.891	1.985	1.510	1.480
*24	1.703	1.375	1.377	—	1 1/2-28UN-2A	1.635	1.874	1.311	—	1.565/1.555	1.775	2.016	2.110	1.635	1.605

*Shell Sizes 20, 22 and 24 are available in long shell series only.

Notes: (1) Max. panel thickness .125

(2) Arrangements containing size 12 contacts, insert protrusion .020/.070

(3) All dimensions are in inches.

HERMETIC SINGLE HOLE MOUNT RECEPTACLES

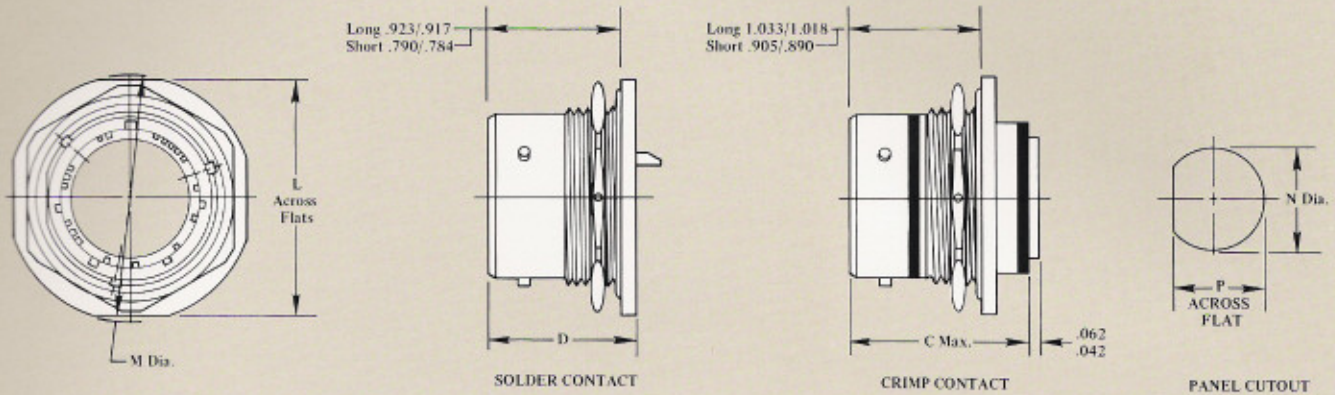

HERMETIC SOLDER MOUNT RECEPTACLES

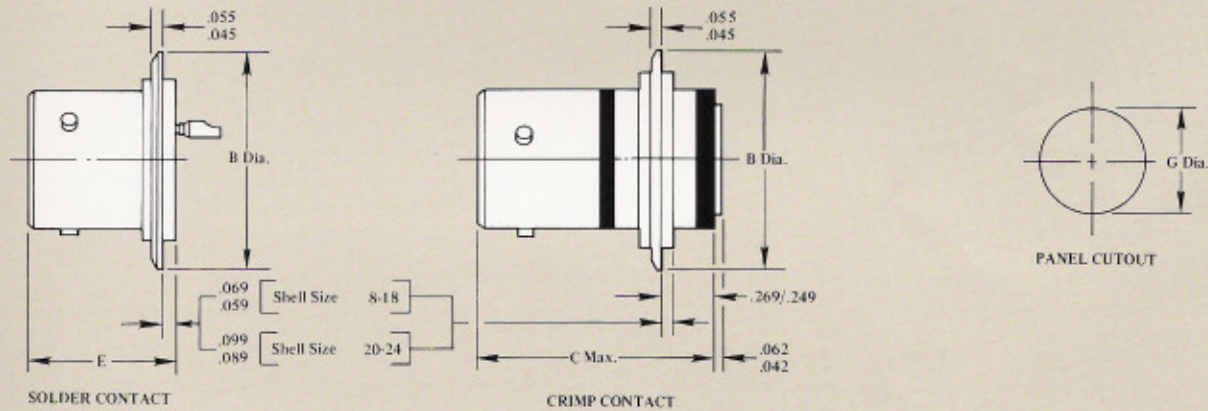

Bands shown are blue on connectors to denote rear release.

Shell Size	B	C MAX.		D MAX.		E ±.010		G ±.005	L ±.010	M ±.010	N ±.005	P ±.005
		Long	Short	Long	Short	Long	Short					
8	.945/.930	1.292	1.165	1.028	.895	.833	.710	.661	.979	1.062	.635	.605
10	1.070/1.055	1.292	1.165	1.028	.895	.833	.710	.786	1.104	1.187	.760	.730
14	1.320/1.305	1.292	1.165	1.028	.895	.833	.710	1.036	1.391	1.500	1.010	.980
16	1.446/1.431	1.292	1.165	1.028	.895	.833	.710	1.162	1.516	1.625	1.135	1.105
18	1.570/1.555	1.292	1.165	1.028	.895	.863	.730	1.286	1.641	1.735	1.260	1.230
*20	1.816/1.801	1.292	—	1.028	—	.893	—	1.441	1.766	1.860	1.385	1.355
*22	1.941/1.926	1.292	—	1.028	—	.893	—	1.566	1.891	1.985	1.510	1.480
*24	2.066/2.051	1.292	—	1.028	—	.893	—	1.691	2.016	2.110	1.635	1.605

*Shell Sizes 20, 22 and 24 are available in long shell series only.

Notes: (1) Max. panel thickness .125

(2) All dimensions are in inches.

Insert Arrangements

A01(0804)
4 NO. 23
CONTACTS



B03(1003)
3 NO. 16
CONTACTS



B02(1005)
5 NO. 20
CONTACTS



B01(1012)
12 NO. 23
CONTACTS



D04(1404)
4 NO. 12
CONTACTS



D03(1409)
9 NO. 16
CONTACTS



D02(1419)
19 NO. 20
CONTACTS



D01(1437)
37 NO. 23
CONTACTS

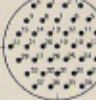

E04(1607)
7 NO. 12
CONTACTS

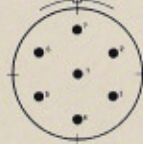

E03(1614)
14 NO. 16
CONTACTS

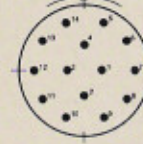

E02(1627)
27 NO. 20
CONTACTS

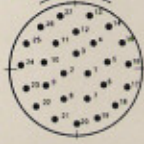

E01(1655)
55 NO. 23
CONTACTS



F04(1809)
9 NO. 12
CONTACTS

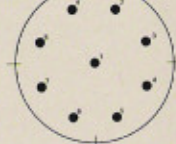

F03(1821)
21 NO. 16
CONTACTS

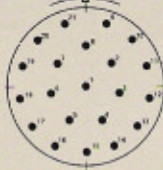

F02(1838)
38 NO. 20
CONTACTS

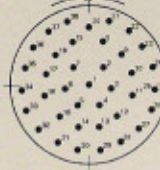

F01(1885)
85 NO. 23
CONTACTS

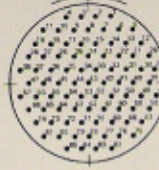

G04(2011)
11 NO. 12
CONTACTS

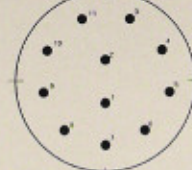

G03(2024)
24 NO. 16
CONTACTS

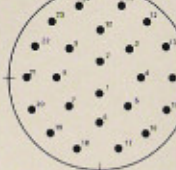

G02(2045)
45 NO. 20
CONTACTS

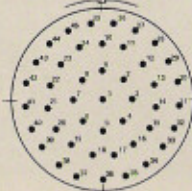

G01(2092)
92 NO. 23
CONTACTS

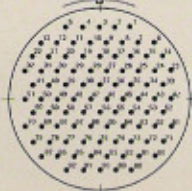

H04(2214)
14 NO. 12
CONTACTS

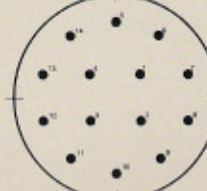

H03(2232)
32 NO. 16
CONTACTS

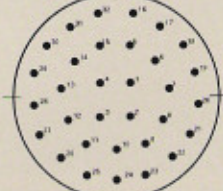

H02(2261)
61 NO. 20
CONTACTS

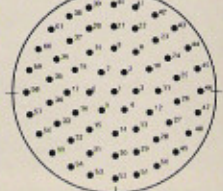

H01(22121)
121 NO. 23
CONTACTS

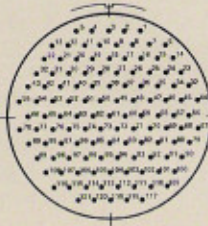

J04(2419)
19 NO. 12
CONTACTS

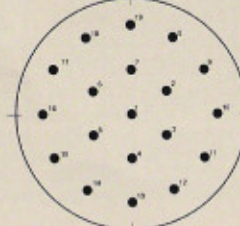

J03(2441)
41 NO. 16
CONTACTS

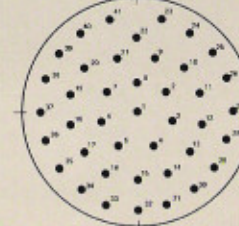

J02(2474)
74 NO. 20
CONTACTS

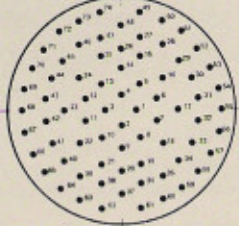

J01(24155)
155 NO. 23
CONTACTS

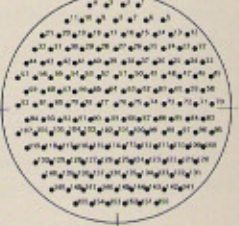

Arrangements are shown looking at pin face (socket is opposite). Cavity identifying numbers are for reference only. Actual marking shall be as required by applicable specifications.

ALTERNATE SHELL KEYING POSITIONS

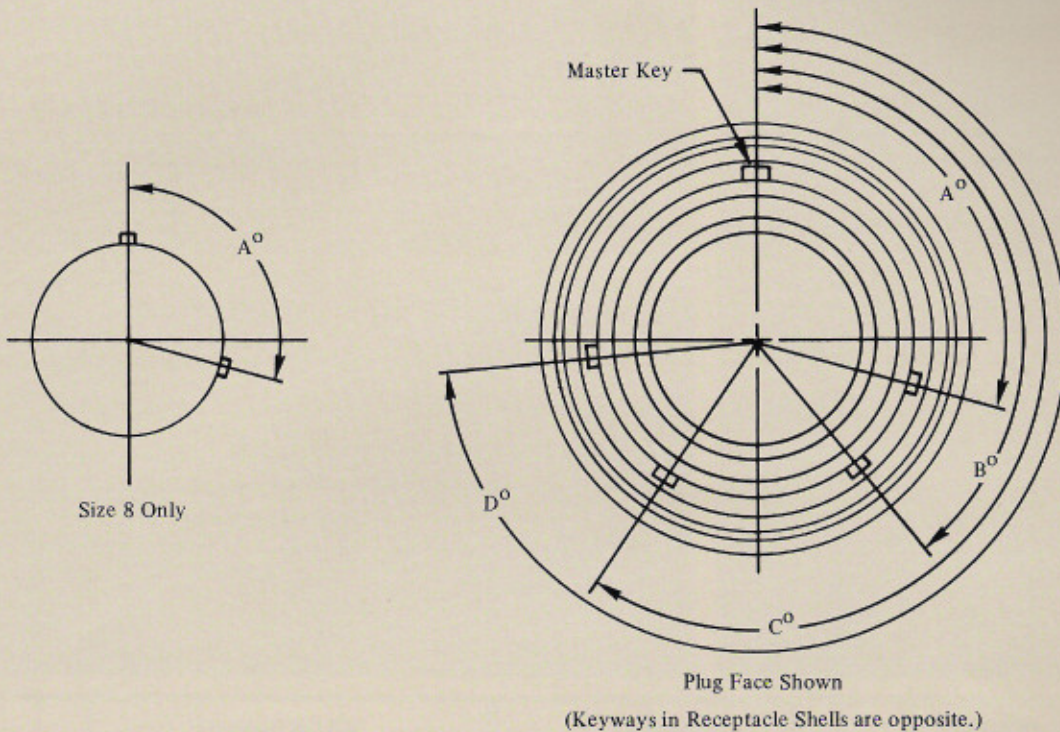

SHORT SHELL KEY/KEYWAY LOCATIONS

Keying Position	SIZE 8				SIZES 10 & 14				SIZES 16 & 18			
	A°	B°	C°	D°	A°	B°	C°	D°	A°	B°	C°	D°
1	128	—	—	—	105	140	215	265	105	140	215	265
2	190	—	—	—	102	132	248	320	18	149	192	259
3	205	—	—	—	80	118	230	312	92	152	222	342
4	220	—	—	—	35	140	205	275	84	152	204	334
5	235	—	—	—	64	155	235	304	24	135	199	240
6	250	—	—	—	35	115	220	270	98	152	268	338

LONG SHELL KEY/KEYWAY LOCATIONS

Keying Position	SIZE 8				SIZES 10 & 14				SIZES 16 & 18				SIZES 20, 22 & 24			
	A°	B°	C°	D°	A°	B°	C°	D°	A°	B°	C°	D°	A°	B°	C°	D°
1	105	140	215	265	95	141	208	236	80	142	196	293	80	142	196	293
2	102	132	248	320	113	156	182	292	135	170	200	310	135	170	200	310
3	80	118	230	312	90	145	195	252	49	169	200	244	49	169	200	244
4	35	140	205	275	53	156	220	255	66	140	200	257	66	140	200	257
5	64	155	234	304	119	146	176	298	62	145	180	280	62	145	180	280
6	91	131	197	240	51	141	184	242	79	153	197	272	79	153	197	272

Contact & Tooling Information

WIRE BARREL CONFIGURATION FOR THE FOLLOWING CONTACT SIZES BY PART NUMBER

81541-23

81542-23

81543-23



PIN CONTACT

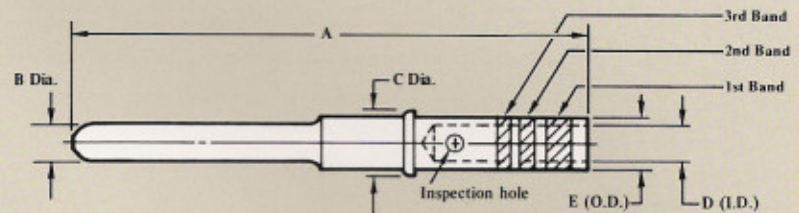

SOCKET CONTACT

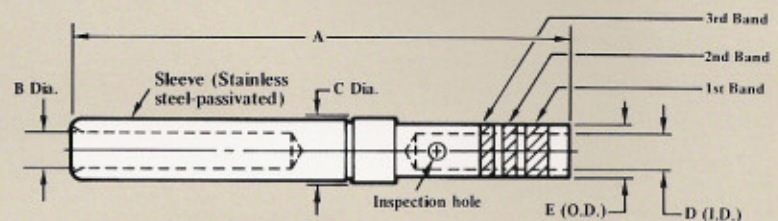

Size	CONTACT		Style	Connector (3) Shell Series	COLOR BANDS			A MAX.	B DIA.	C MAX.
	Deutsch Part Number	Military Part Number			First	Second	Third			
23	81541-23	M39029/18-23-22	PIN	A & B	VIOLET	VIOLET	BROWN	.644	.0275/.0260	.058
23	81542-23	M39029/16-23-22	SOCKET	B	VIOLET	BLUE	BROWN	.625	.031/.029	.058
23	81543-23	M39029/17-23-22	SOCKET	A	RED	VIOLET	BROWN	.955	.031/.029	.058
23	81541-238	M39029/18-23-28	PIN	A & B	BLUE	VIOLET	BROWN	.644	.0275/.0260	.058
23	81542-238	M39029/16-23-28	SOCKET	B	BLUE	BLUE	BROWN	.625	.031/.029	.058
23	81543-238	M39029/17-23-28	SOCKET	A	BROWN	VIOLET	BROWN	.955	.031/.029	.058
22	CTS-S22/22	M39029/22-22-22	SOCKET	L	BROWN	WHITE	BROWN	.345	.033/.031	.064
20	81541-20	M39029/18-20-20	PIN	A & B	GRAY	VIOLET	BROWN	.644	.041/.039	.079
20	81542-20	M39029/16-20-20	SOCKET	B	GRAY	BLUE	BROWN	.625	.044/.042	.079
20	81543-20	M39029/17-20-20	SOCKET	A	ORANGE	VIOLET	BROWN	.955	.044/.042	.079
20	109032	M39029/15-20-20	SOCKET	L	RED	RED	NONE	.345	.044/.042	.079
16	81541-16	M39029/18-16-16	PIN	A & B	WHITE	VIOLET	BROWN	.644	.063/.061	.111
16	81542-16	M39029/16-16-16	SOCKET	B	WHITE	BLUE	BROWN	.625	.068/.065	.111
16	81543-16	M39029/17-16-16	SOCKET	A	YELLOW	VIOLET	BROWN	.955	.068/.065	.111
16	109033	M39029/15-16-16	SOCKET	L	BLUE	BLUE	NONE	.345	.066/.064	.111
12	81541-12	M39029/18-12-12	PIN	A & B	BLACK	GRAY	BROWN	.680	.095/.093	.172
12	81542-12	M39029/16-12-12	SOCKET	B	BLACK	VIOLET	BROWN	.650	.100/.097	.172
12	81543-12	M39029/17-12-12	SOCKET	A	GREEN	VIOLET	BROWN	.970	.100/.097	.172

NOTES: (1) Body material: Per MIL-C-39039, composition A.

(2) Body finish: Gold per MIL-G-45204, type II, class 1, over a suitable underplating, excluding silver.

(3) Contacts designed for use in long (A) or short (B) shell series or Hermetic rear release (L) connectors as designated in tab block.

CONTACT RETENTION MECHANISM TESTING

To verify the design integrity of the Deutsch contact retention mechanism, a number of rigorous tests have been performed.

- Temperature life with contact retention
- Gage location and retention
- Pin stability
- Retention system fluid exposure
- Insertion/removal tool abuse
- Contact retention
- Contact walkout

These tests are described in detail in specification MIL-C81511.

NOTES:

1. Shielded wire contacts may be substituted for size 16 and size 12 power contacts by replacing the dash in the Deutsch insert arrangement number with the applicable cable group indicator (see page 8). See page 10 for details on shielded wire contacts.
2. Thermocouple contacts are also available. See page 11 for details.

D MIN.	E MAX.	Weight MAX. (lbs.)	Wire Gage	Crimp Tool Positioner (4) (5)	Strip Length ±.030	Deutsch Insertion Extraction Tool	Military Insertion Extraction Tool	Sealing Plugs Deutsch Part Number	Sealing Plugs Military Part Number
.033	.050	.00023	22 THRU 28	K338-1 (M22520/2-13)	.192	81515-23	MS3160-22	81539-23	M81511/39-22
.033	.050	.00023	22 THRU 28	K338-1 (M22520/2-13)	.192	81515-23	MS3160-22	81539-23	M81511/39-22
.033	.050	.00057	22 THRU 28	K339-1 (M22520/2-16)	.192	81515-23	MS3160-22	81539-23	M81511/39-22
.018	.050	.00053	28 THRU 32	K338-1 (M22520/2-13)	.192	81515-23	MS3160-22	81539-23	M81511/39-22
.018	.050	.00053	28 THRU 32	K338-1 (M22520/2-13)	.192	81515-23	MS3160-22	81539-23	M81511/39-22
.018	.050	.00053	28 THRU 32	K339-1 (M22520/2-16)	.192	81515-23	MS3160-22	81539-23	M81511/39-22
.033	.050	.00011	22 THRU 28	K330-1 (M22520/2-19)	.207	81515-23	MS3160-22	—	—
.042	.063	.00034	20 THRU 24	K340-1 (M22520/2-14)	.232	81515-20	MS3160-20	81539-20	M81511/39-20
.042	.063	.00045	20 THRU 24	K340-1 (M22520/2-14)	.232	81515-20	MS3160-20	81539-20	M81511/39-20
.042	.063	.00102	20 THRU 24	K342-1 (M22520/2-17)	.232	81515-20	MS3160-20	81539-20	M81511/39-20
.042	.063	—	20 THRU 24	K331-1 (M22520/2-20)	.207	81515-20	MS3160-20	—	—
.062	.094	.00090	16 THRU 20	K341-1 (M22520/2-15)	.232	81515-16	MS3160-16	81539-16	M81511/39-16
.062	.094	.00090	16 THRU 20	K341-1 (M22520/2-15)	.232	81515-16	MS3160-16	81539-16	M81511/39-16
.062	.094	.00190	16 THRU 20	K343-1 (M22520/2-18)	.232	81515-16	MS3160-16	81539-16	M81511/39-16
.062	.094	—	16 THRU 20	K332-1 (M22520/2-21)	.207	81515-16	MS3160-16	—	—
.097	.153	.00231	12 AND 14	TP360-1 (M22520/1-09)	.266	81515-12	MS3160-12	81539-12	M81511/39-12
.097	.153	.00242	12 AND 14	TP360-1 (M22520/1-09)	.266	81515-12	MS3160-12	81539-12	M81511/39-12
.097	.153	.00517	12 AND 14	TP365-1 (M22520/1-10)	.266	81515-12	MS3160-12	81539-12	M81511/39-12

(4) For termination of size 23 thru 16 contacts, use Daniels AFM8 (M22520/2-01) crimp tool with appropriate positioner per tab block. For size 12 contacts, use Daniels AF8 (M22520/1-01) crimp tool with appropriate positioner. Equivalent military tool and positioner part numbers are shown in parentheses.

(5) For equivalent Buchanan crimp tool and positioner part numbers, see information drawing 107901.

Ordering Information

DEUTSCH PART NUMBERING SYSTEM

B 815 10 F 08 - 04 P 1-3019

Series:

A=Long shell series (100% scoop proof)
B=Short shell series (50% scoop proof)

Basic Identifier:

Shell Style:

10=Square flange receptacle
11=Solder mount receptacle (hermetic only)
13=Cable connecting receptacle
14=Single hole mount receptacle
16=Plug

Class:

A = Grommet Seal Fluid Resistant 200°C.
F = Grommet Seal Fluid Resistant 175°C.
D = Hermetic (solder pot) 175°C. (cold roll steel)
L = Hermetic (crimp contacts) 175°C. (cold roll steel)
W = Grommet Seal Fluid Resistant³ 500 Hour Salt Spray 175°C.

Modification Number: (See class W)

Key Position, 1, 2, 3, 4, 5, 6 (Position 1: Normal) (See page 5 for details)

Contact Style:

P = Pin
S = Soc
A = Less Pin Contact
B = Less Soc Contact

Insert Arrangement: (See page 4 for details)

Shielded contact "cable group" indicator: (Applicable to insert arrangements with No. 16 or No. 12 power contacts only.) When shielded contacts are desired, replace dash (-) with letter C, D, or E as determined from cable group specifications shown on page 10. See note 1.

Shell Size:

8, 10, 14, 16, 18, 20*, 22*, 24*

*Available in long series only.

Notes: 1. The addition of a "cable group" indicator letter assures that a full compliment of shielded contacts will be supplied in lieu of the power contacts. If a combination of power and shielded contacts are required within the same arrangement, order a standard connector and, in addition, order the necessary shielded contacts separately. See page 10.

2. Thermocouple contacts are available. See page 11 for part numbers.

3. Add -3019 Modification.

APPLICABILITY OF CLASSES

CLASS	SERIES 3 (100% Scoop-proof)					SERIES 4 (50% Scoop-proof)				
	F	A	D	L	W	F	A	D	L	W
Square Flange Receptacle	/41 A81510	/41 A81510	—	—	/41 A81510	/51 B81510	/51 B81510	—	—	/51 B81510
Solder Mount Hermetic Receptacle	—	—	/42 A81511	/47 A81511	—	—	—	/52 B81511	/57 B81511	—
Single Hole Mount Receptacle	/49 A81514	/49 A81514	/44 A81514	/48 A81514	/49 A81514	/53 B81514	/53 B81514	/54 B81514	/50 B81514	/53 B81514
Cable Connecting Receptacle	/45 A81513	/45 A81513	—	—	/45 A81513	/55 B81513	/55 B81513	—	—	/55 A81513
Plug	/46 A81516	/46 A81516	—	—	/46 A81516	/56 B81516	/56 B81516	—	—	/56 B81516

MILITARY STANDARD PART NUMBERING SYSTEM

M81511/ 41 F D 01 P 1

Basic Military Part No.

Specification Slash No. and Shell Style

Series 3.—Long shell series (100% scoop proof)¹

/41 Square Flange Receptacle

/42 Solder Mount Receptacle (Class D Hermetic)

/44 Single Hole Mount Receptacle
(Class D Hermetic)

/45 Cable Connecting Receptacle

/46 Plug

/47 Solder Mount Receptacle (Class L Hermetic)

/48 Single Hole Mount Receptacle
(Class L Hermetic)

/49 Single Hole Mount Receptacle

Series 4.—Short shell series (50% scoop proof)¹

/50 Single Hole Mount Receptacle
(Class L Hermetic)

/51 Square Flange Receptacle

/52 Solder Mount Receptacle (Class D Hermetic)

/53 Single Hole Mount Receptacle

/54 Single Hole Mount Receptacle
(Class D Hermetic)

/55 Cable Connecting Receptacle

/56 Plug

/57 Solder Mount Receptacle (Class L Hermetic)

Alternate Keying Positions:

1, 2, 3, 4, 5, 6

Position 1=Normal(See page 5 for details)

Contact Style:

P=Pin

S=Socket

A=Less Pin Contact

B=Less Socket Contacts

Insert Arrangement:

(See page 4 for details)

Shell Size: (use letter designation)

8	10	14	16	18	20*	22*	24*
A	B	D	E	F	G	H	J

Class:

A =200°C. Grommet Seal
Fluid Resistant

F =175°C. Grommet Seal
Fluid Resistant

D =175°C. Hermetic Solder Contacts

L =175°C. Hermetic Crimp Contacts

W=Grommet Seal Fluid Resistant
500 Hour Salt Spray 175°C.

¹Available in long series only.

Note: 1. For shell configuration see applicability of classes.

OTHER DESIGN FEATURES

Individual Contact Sealing

Pin contacts are surrounded by conical-shaped risers which fit into chamfered lead-ins of the socket inserts upon mating. This "cork-in-bottle" sealing effect assures individual contact sealing at the connector interface.

Pin contacts are encapsulated in closely-toleranced rigid plastic to prevent excessive splaying, yet the design provides sufficient "float" to assure proper alignment of contacts.

Protection Against Bent Pins or Sockets Is Built Into the Design

If a pin is bent only slightly, the lead-in-chamber of the rigid plastic face acts as a funnel, straightening the pin and guiding it into the socket for proper engagement. The closely-toleranced plastic will not accept a contact that is bent beyond pre-established limits.

Multiple Seals Provide Protection Against Internal and External Contamination

In addition to individual contact sealing, the 815 Series connectors incorporate additional protective seals: interfacial compression seal, peripheral static/dynamic shell-to-shell seal, insert to shell seal, and redundant wire seals to assure absolute sealing against environmental extremes.

Grounding Fingers To Reduce RFI

Spring fingers, located in the receptacle of the 50% scoop-proof version, and in the plug of the 100% scoop-proof version, assure a highly conductive path to ground for direct current as well as RFI signals. These grounding fingers make electrical engagement before the contacts engage. They meet or exceed the shell conductivity and attenuation requirements of MIL-C-81511.

Shielded Wire Contacts FOR REDUCED RFI

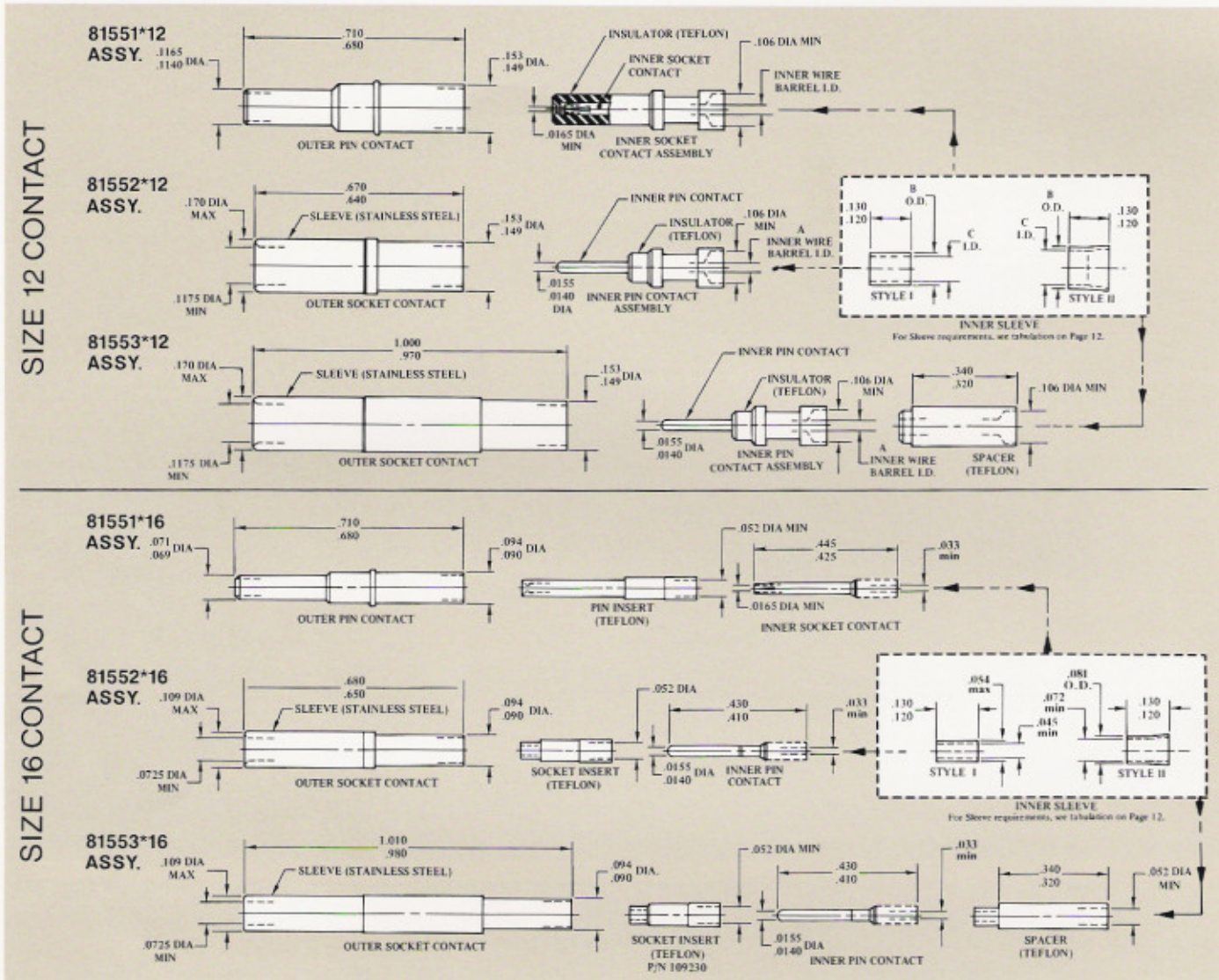

CONTACT ASSEMBLY SPECIFICATIONS				
SIZE	CABLE GROUP (2)	CONTACT ASSEMBLY PART NUMBER	INNER CONTACT	
			PART NUMBER	A MIN.
16	C	81551C16	109228	.033
		81552C16	109227	
		81553C16		
12	C	81551C12	109252	.021
		81552C12	109251	
		81553C12		
12	D	81551D12	109245	.033
		81552D12	109244	
		81553D12		
12	E	81551E12	109245	.033
		81552E12	109244	
		81553E12		

INNER SLEEVE SPECIFICATIONS						
SIZE	CABLE GROUP	PART NUMBER	STYLE	B	C	CABLE ACCOMMODATION
				MAX	MIN	
16	C	109233	II	.081	.072	M81044/18-22 Shielded
		111788	I	.054	.045	
		109233	II	.081	.072	
12	C	NONE USED	—	—	—	RG-180B/U MICRODOT 293-3922
		109254	II	.128	.109	RAYCHEM 9530D5117
		109253	II	.128	.113	M81044/18-22 Shielded
12	D	109256	I	.104	.081	M27500-22RC156 REVERE WH95623
		109255	II	.128	.118	MICRODOT 250-4070
		109255	II	.128	.118	RAYCHEM 5022E5111
		111789	I	.100	.091	
12	E	109253	II	.128	.113	RG 179B/U RG 188A/U
		109256	I	.104	.081	
		111789	I	.100	.091	

Thermocouple Contacts

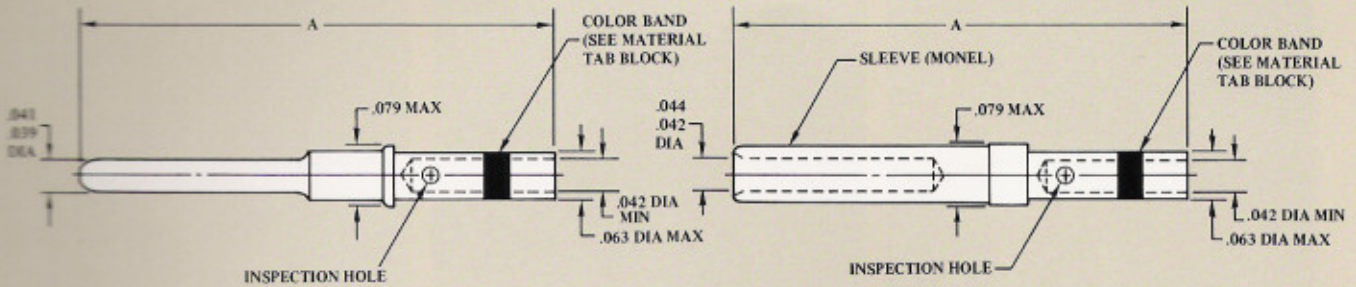

THERMOCOUPLE CONTACT SPECIFICATIONS

CONTACT (1) PART NUMBER	STYLE	CONNECTOR SHELL SERIES	A MAX	CRIMP TOOL POSITIONER
81561-20*	PIN	A&B	.650	K340-1 (M22520/2-14)
81562-20*	SOCKET	B	.625	K340-1 (M22520/2-14)
81563-20*	SOCKET	A	.955	K342-1 (M22520/2-17)

MATERIAL

MATERIAL DESIGNATION	CONTACT MATERIAL	BODY PLATING	COLOR BAND	MATCHING CONTACT MATERIAL	ISA CURVE
0	COPPER	GOLD FLASH	BROWN	COPPER CONSTANTAN	T
1	IRON	GOLD FLASH	WHITE	IRON CONSTANTAN	J
2	ALUMEL	UNPLATED	ORANGE	CHROMEL	K
3	CHROMEL	UNPLATED	BLACK	ALUMEL	K
4	COPPER CONSTANTAN	UNPLATED	GREEN	COPPER	T
5	IRON CONSTANTAN	UNPLATED	PURPLE	IRON	J

Notes to Shielded Wire Contacts:

1. Asterisk in shielded wire contact P/N identifies cable group. Replace asterisk with appropriate cable group letter.
2. For shielded wire contacts use insertion/extraction tool 81515-12 for size 12 Contacts and 81515-16 for size 16 Contacts.
3. Assembly instructions for shielded wire contacts are available. Request form 670 for Cable Group C, 671 for Cable Group D or 672 for Cable Group E.

Note to Thermocouple Contacts:

1. Asterisk in thermocouple contact P/N identifies material. Replace asterisk with appropriate "material designation" number when ordering. See material tabulation for appropriate number.

GENERAL SPECIFICATIONS

DIELECTRIC WITHSTANDING VOLTAGE (Test Voltage) VAC(rms)

SEA LEVEL	Service Rating I	
	MATED	UNMATED
	1800	1500

SEA LEVEL	Service Rating II	
	MATED	UNMATED
	2300	2300

CONTACT SPACING (Min. Nominal)

23	.084 Center to Center
20	.1195 Center to Center
16	.160 Center to Center
12	.230 Center to Center

CURRENT RATING

23	5.0 Amps.
20	7.5 Amps.
16	13 Amps.
12	23 Amps.

SILICONE INSERT

Front and rear silicone inserts are devoid of all organic matter.

CORROSION

Meets requirements of MIL-STD-1344, method 1001, test condition B.

CONTACT MILLIVOLT DROP

23	70 millivolts at 5 amps & 25°C
20	55 millivolts at 7.5 amps & 25°C
16	50 millivolts at 13 amps & 25°C
12	50 millivolts at 23 amps & 25°C

VIBRATION

Meets requirements of MIL-C-81511.

DIELECTRIC STRENGTH

300 volts/mil

CRIMP RETENTION

Meets requirements of MIL-STD-39029.

USABLE WIRE SIZE

23 Size Contact—Receive conductor

AWG 22 thru 26. Rear Insert will seal on smooth insulation from .030" to .054 O.D.
20 Size Contact—Receive conductor AWG 20 thru 24. Rear Insert will seal on smooth insulation from .040" to .074" O.D.
16 Size Contact—Receive conductor AWG 16 thru 20. Rear Insert will seal on smooth insulation from .060" to .103" O.D.
12 Size Contact—Receive conductor AWG 12 thru 14. Rear Insert will seal on smooth insulation from .097" to .135" O.D.

INSULATION RESISTANCE

5000 Megohms minimum at 25°C.

MOISTURE RESISTANCE

Insulation resistance in excess of 500 megohms at 25°C when tested in accordance with MIL-C-81511E.

TEMPERATURE

Operative at temperatures from -65°C to +200°C (Class A)
-65°C to +175°C (Class W)

CONTACT RETENTION

Contacts withstand a minimum load of:

	Contact Size
12 lbs	23
15 lbs	20
25 lbs	16
25 lbs	12

THERMAL SHOCK

Meets Requirements of MIL-C-81511.

DURABILITY

No electrical or mechanical defects after 500 cycles of engagement and disengagement per MIL-C-81511E.

ALTITUDE IMMERSION

Meets requirements of MIL-C-81511.

AIR LEAKAGE

Less than 0.01 micron cu. ft./hr. at 14.7 psi differential per MIL-C81511.

DIELECTRIC WITHSTANDING VOLTAGE (Test Voltage) ALTITUDE

Wired, assembled, unmated connectors will withstand:

Service Rating I	Service Rating II	Simulated Altitude
700 VAC (rms)	800 VAC (rms)	50,000 ft
375 VAC (rms)	500 VAC (rms)	70,000 ft
200 VAC (rms)	200 VAC (rms)	110,000 ft