

REVISIONS					
P	LTR	DESCRIPTION	DATE	DWN	APVD
D6		REVISED PER ECN-24-283634	09SEP2024	SJ	WT

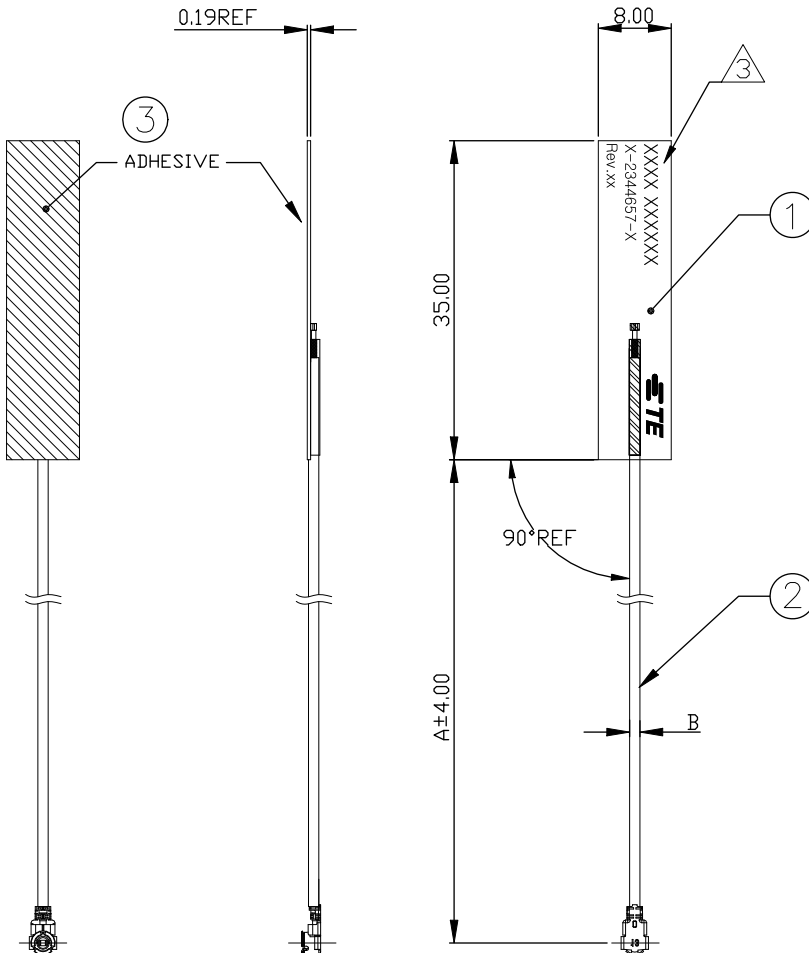

1. MATERIALS : REFER TO TABLE.
2. FABRICATE TO MEET IPC -6013, CLASS2
INSPECT TO MEET IPC -A-600, CLASS2
3. IDENTIFICATION INCLUDES : FOUR DIGIT DATE CODE(FIRST 2 DIGITS FOR THE WEEK CODE AND THE 2ND TWO DIGITS FOR THE YEAR CODE), MANUFACTURING CONTROL NUMBER, TE PART NUMBER & REVISION NO.
4. CONSULT TE CONNECTIVITY DATA SHEET DS 2344657.

CONNECTOR TYPE	B DIMENSION	A DIMENSION	PART NUMBER
UMCC GEN.4 (MHF4 TYPE)	0.81	250	1-2344657-2
		300	1-2344657-1
		200	2344657-8
		150	2344657-7
		100	2344657-6
UMCC GEN.1 (MHF1 TYPE)	1.13	50	2344657-5
		300	1-2344657-3
		250	2344657-9
		200	2344657-4
		150	2344657-3
100	2344657-2		
50	2344657-1		

MATERIAL	NAME	ITEM NO.
DOUBLE-SIDED TAPE	ADHESIVE 3M TAPE	3
COAXIAL CABLE & CONN	CABLE ASSY	2
PI FILM	FPCB ANTENNA	1

THIS DRAWING IS A CONTROLLED DOCUMENT.

DWN	PAUL HUNAG	22OCT2018
CHK	AKU HUANG	22OCT2018
APVD	AMOS CHEAH	22OCT2018
PRODUCT SPEC	-	
APPLICATION SPEC	-	
WEIGHT	0	

STE TE Connectivity Ltd.

NAME: WLAN DUAL BAND ANTENNA FPC H

SIZE	A3	CAGE CODE	00779	DRAWING NO	C=2344657	RESTRICTED TO	-
------	----	-----------	-------	------------	-----------	---------------	---

CUSTOMER DRAWING SCALE 1:1 SHEET 1 OF 4 REV D6

REVISIONS					
P	LTR	DESCRIPTION	DATE	DWN	APVD
-	-	SEE SHEET 1	-	-	-

PACKAGING P/Ns : 2344657-1,-2,-3,-4

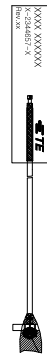

25PCS/BUNCH

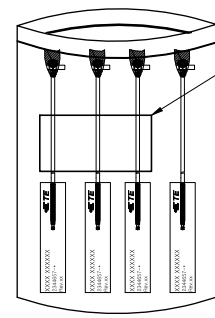

200PCS/BAG
DESICCANT:1PCS/BAG

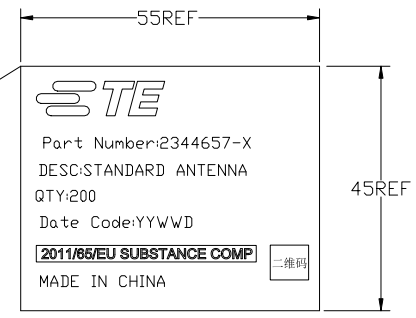

PACKING LABEL

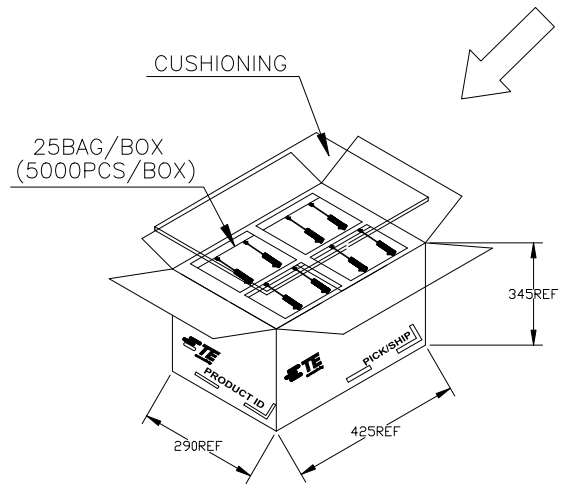

25BAG/BOX
(5000PCS/BOX)

CUSHIONING

345REF

290REF 425REF

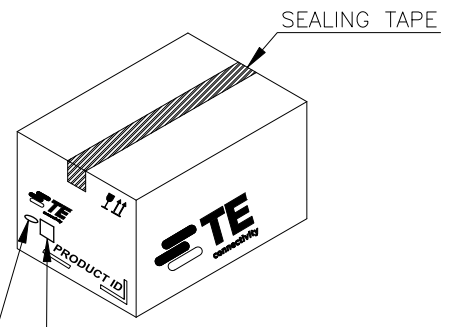
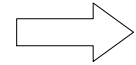

SEALING TAPE

MONTH LABEL

BOX LABEL

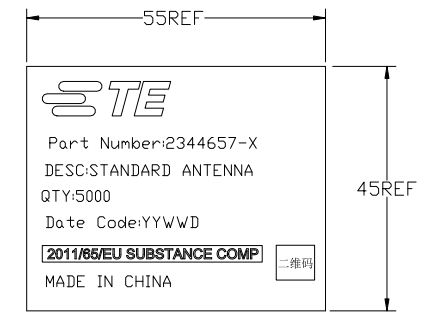

BOX LABEL

THIS DRAWING IS A CONTROLLED DOCUMENT.		DWN PAUL HUNAG 22OCT2018	TE Connectivity Ltd.			
		CHK AKU HUANG 22OCT2018				
DIMENSIONS: mm		APVD AMOS CHEAH 22OCT2018	NAME			
		PRODUCT SPEC	WLAN DUAL BAND ANTENNA FPC H			
TOLERANCES UNLESS OTHERWISE SPECIFIED: 0 PLC ± - 1 PLC ± - 2 PLC ± - 3 PLC ± - 4 PLC ± - ANGLES ± -		APPLICATION SPEC	-			
MATERIAL -		WEIGHT -	SIZE A3	CAGE CODE 00779	DRAWING NO C=2344657	RESTRICTED TO -
FINISH -		CUSTOMER DRAWING		SCALE NTS	SHEET 2 of 4	REV D6

REVISIONS					
P	LTR	DESCRIPTION	DATE	DWN	APVD
-	-	SEE SHEET 1	-	-	-

PACKAGING P/Ns : 2344657-5,-6,-7,-8

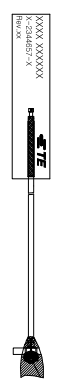

25PCS/BUNCH

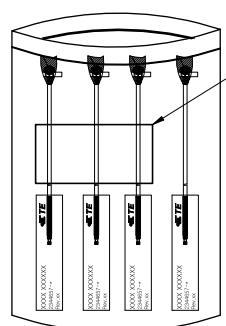

200PCS/BAG
DESICCANT:1PCS/BAG

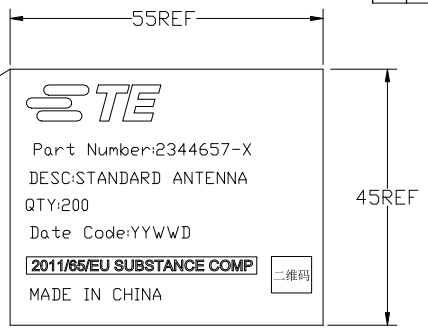

PACKING LABEL

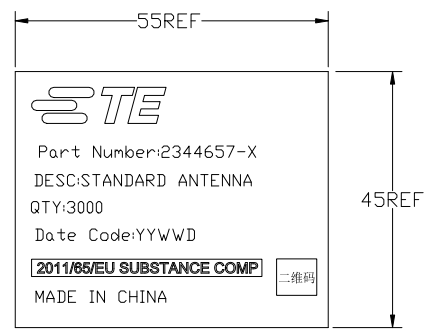
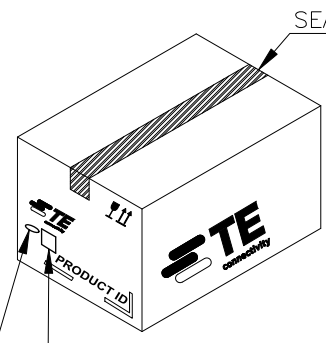
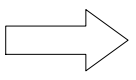
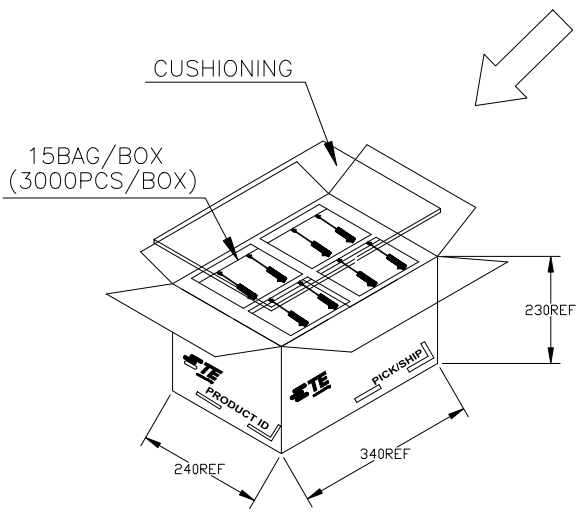

THIS DRAWING IS A CONTROLLED DOCUMENT.		DWN PAUL HUNAG 22OCT2018	BOX LABEL														
DIMENSIONS: mm		CHK AKU HUANG 22OCT2018	STE TE Connectivity Ltd.														
TOLERANCES UNLESS OTHERWISE SPECIFIED:		APVD AMOS CHEAH 22OCT2018	NAME WLAN DUAL BAND ANTENNA FPC H														
<table border="1"> <tr><td>0 PLC</td><td>± -</td></tr> <tr><td>1 PLC</td><td>± -</td></tr> <tr><td>2 PLC</td><td>± -</td></tr> <tr><td>3 PLC</td><td>± -</td></tr> <tr><td>4 PLC</td><td>± -</td></tr> <tr><td>ANGLES</td><td>± -</td></tr> </table>		0 PLC	± -	1 PLC	± -	2 PLC	± -	3 PLC	± -	4 PLC	± -	ANGLES	± -	PRODUCT SPEC -	-		
0 PLC	± -																
1 PLC	± -																
2 PLC	± -																
3 PLC	± -																
4 PLC	± -																
ANGLES	± -																
MATERIAL -		APPLICATION SPEC -	SIZE A3	CAGE CODE 00779	DRAWING NO C=2344657												
FINISH -		WEIGHT 0	RESTRICTED TO -		SCALE 1:1												
CUSTOMER DRAWING			SHEET 3 of 4		REV D6												

REVISIONS

P	LTR	DESCRIPTION	DATE	DWN	APVD
-	-	SEE SHEET 1	-	-	-

PACKAGING P/Ns : 2344657-9, 1-2344657-1, 1-2344657-2, 1-2344657-3, 1-2344657-4

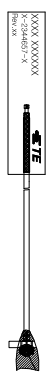

25PCS/BUNCH

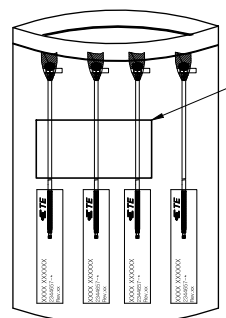

100PCS/BAG
DESICCANT:1PCS/BAG

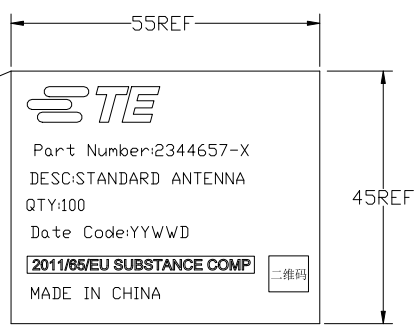

PACKING LABEL

CUSHIONING

30BAG/BOX
(3000PCS/BOX)

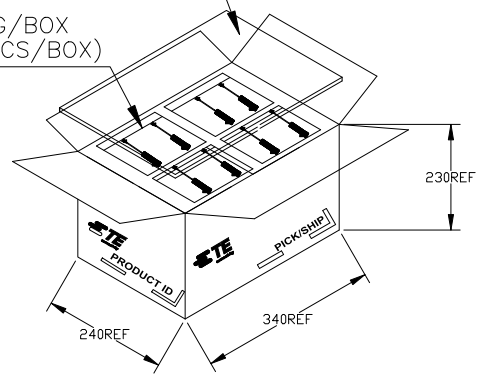

SEALING TAPE

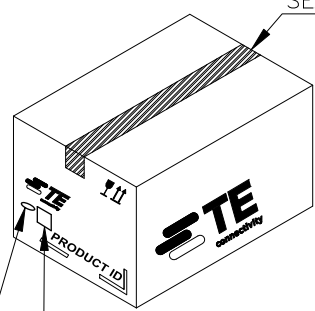

MONTH LABEL

BOX LABEL

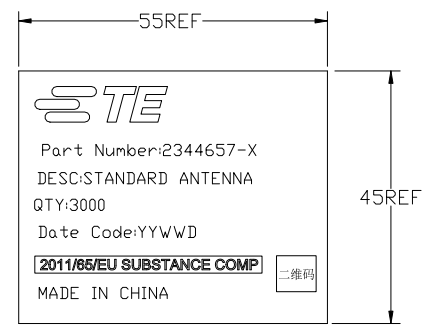

BOX LABEL

THIS DRAWING IS A CONTROLLED DOCUMENT.		DWN	22OCT2018	TE Connectivity Ltd. WLAN DUAL BAND ANTENNA FPC H		
DIMENSIONS: mm		CHK	22OCT2018			
TOLERANCES UNLESS OTHERWISE SPECIFIED:		APVD	22OCT2018			
0 PLC ± - 1 PLC ± - 2 PLC ± - 3 PLC ± - 4 PLC ± - ANGLES ± -		PRODUCT SPEC	NAME			
MATERIAL	FINISH	APPLICATION SPEC	SIZE	CAGE CODE	DRAWING NO	RESTRICTED TO
-	-	WEIGHT	0	A3	00779	©=2344657
CUSTOMER DRAWING			SCALE	1:1	SHEET	4 of 4
			REV	D6		