

P	LTR	DESCRIPTION	DATE	DWN	APVD
	A	INITIAL RELEASE	28FEB2022	SL	LH
	A1	REV.PER ECR-24-206030	25MAR2024	MT	LH

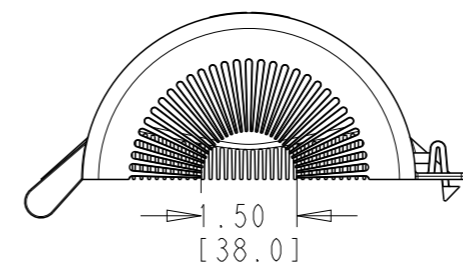

BCAC-IC2-5D/14/1.5

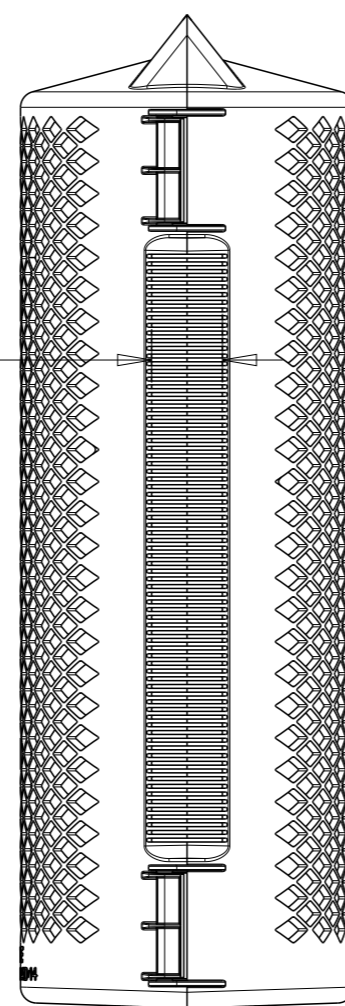
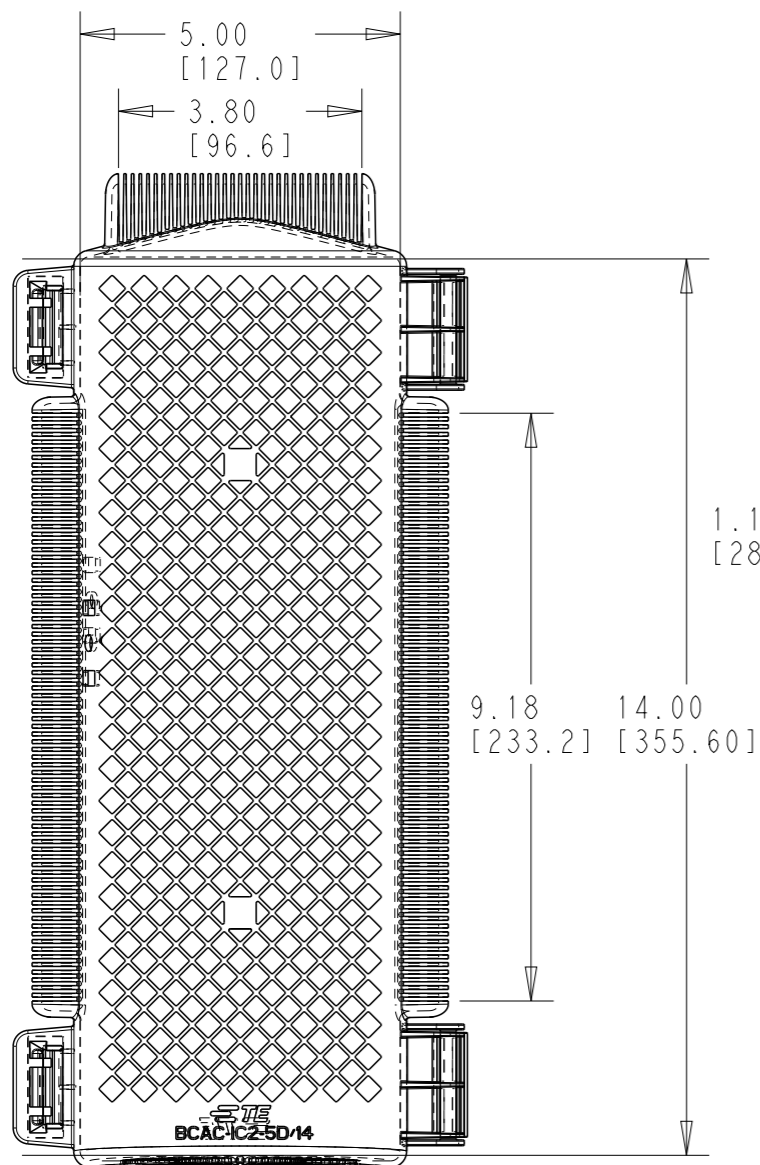
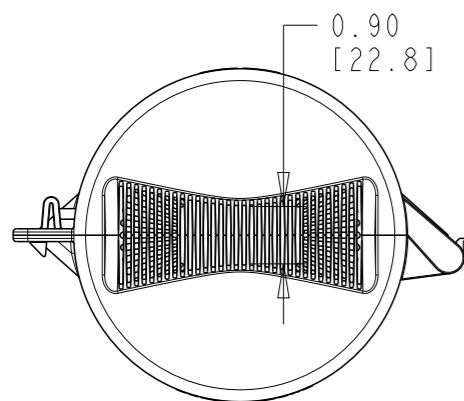
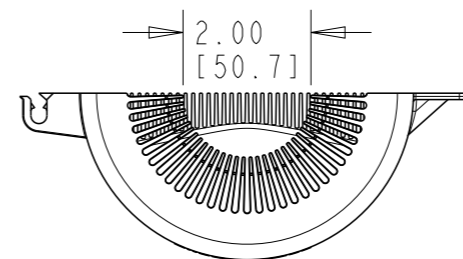

BCAC-IC2-5D/14/2

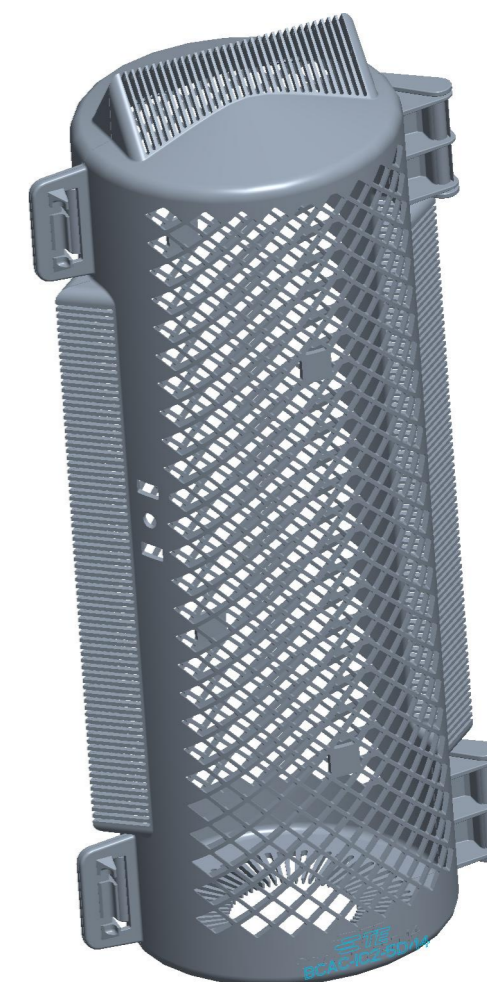

TCPN	DESCRIPTION	MATERIAL
ER9002-000	BCAC-IC2-5D/14/1.5(B6)	TE STANDARD RED
ER9004-000	BCAC-G-IC2-5D/14/1.5(B6)	TE STANDARD GRAY
ER8969-000	BCAC-P-IC2-5D/14/1.5(B6)	GRAY POLYMER
ER9003-000	BCAC-IC2-5D/14/2(B6)	TE STANDARD RED
ER9005-000	BCAC-G-IC2-5D/14/2(B6)	TE STANDARD GRAY
ER9001-000	BCAC-P-IC2-5D/14/2(B6)	GRAY POLYMER
ES3104-000	BCAC+G-IC2-5D/14/2(B6)	TE STANDARD GRAY VO
ES3102-000	BCAC+G-IC2-5D/14/1.5(B6)	TE STANDARD GRAY VO

NOTES:

1. PARTS ARE KITTED 6 ASSEMBLIES PER BOX. EACH ASSEMBLY CONSISTS OF 2 HALVES SNAPPED TOGETHER. PII-XXXXXX-XXX ALSO INCLUDED.

2. EACH BOX SHALL BE LABELLED WITH PART DESCRIPTION, LOT NUMBER, QUANTITY, PART NUMBER, AND MANUFACTURING DATE.

THIS DRAWING IS A CONTROLLED DOCUMENT.

DIMENSIONS: in [mm]	TOLERANCES UNLESS OTHERWISE SPECIFIED:
	0 PLC ±-
	1 PLC ±0.1
	2 PLC ±0.02
	3 PLC ±0.005
	4 PLC ±0.0005
MATERIAL TBD	FINISH -

DWN	SL	28FEB2022
CHK	LH	28FEB2022
APVD	LH	28FEB2022
PRODUCT SPEC	-	
APPLICATION SPEC	-	
WEIGHT	-	
CUSTOMER DRAWING	-	

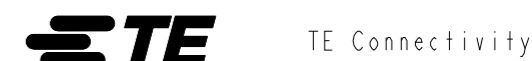

NAME BCAC-IC2-5D/14/1.5(B6) BCAC-G-IC2-5D/14/1.5(B6)		RESTRICTED TO -	
SIZE A3	CAGE CODE 00779	DRAWING NO E00002043	
SCALE 1:3		SHEET 1 OF 1	REV A1