

REV NC	SRK15-MD*32A-001-G003	REVISIONS		
SYM	DESCRIPTION	DATE	APPROVED	
NC	NEW RELEASE PER E.O. P20533	6-28-10	RDR	

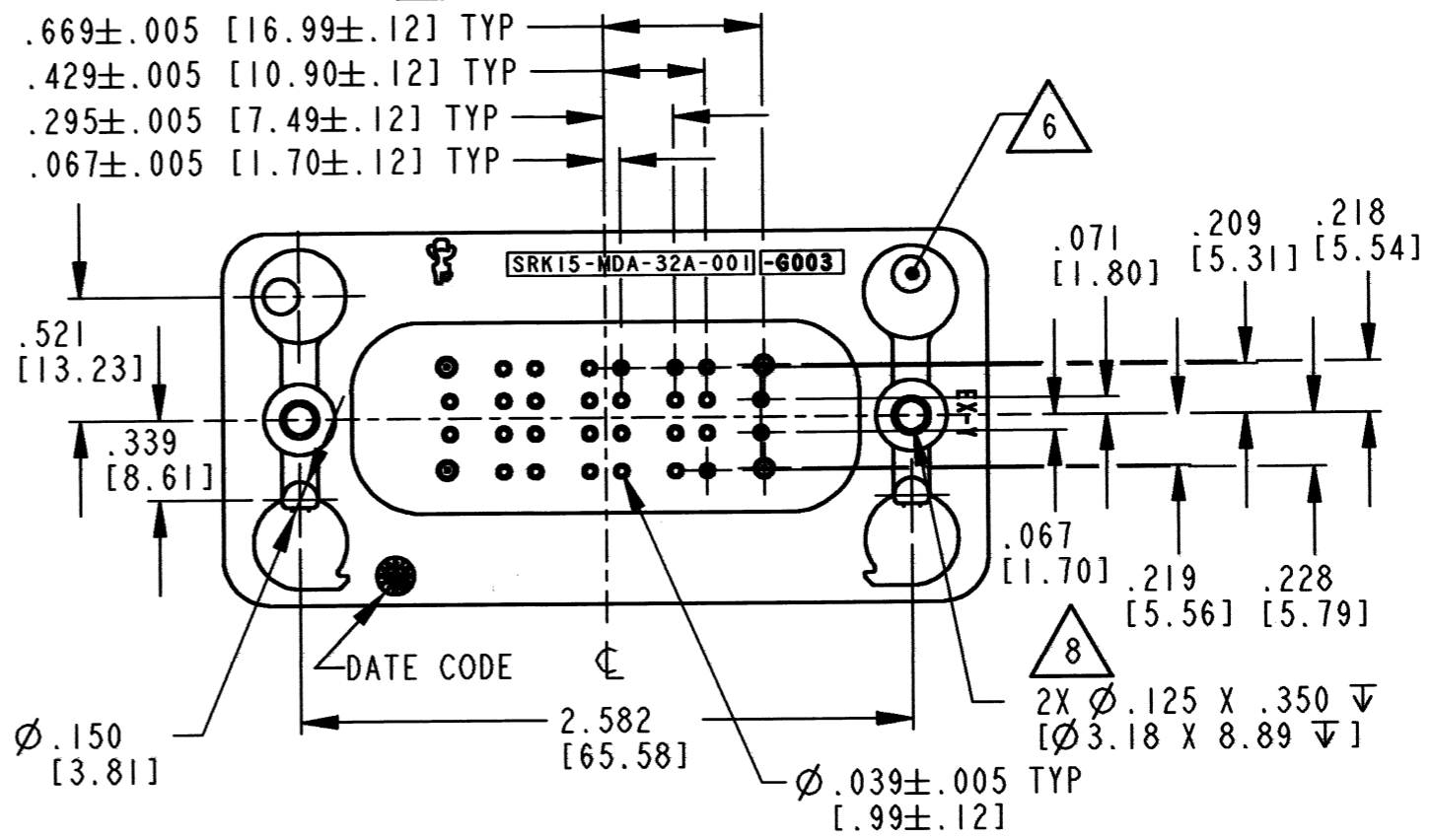
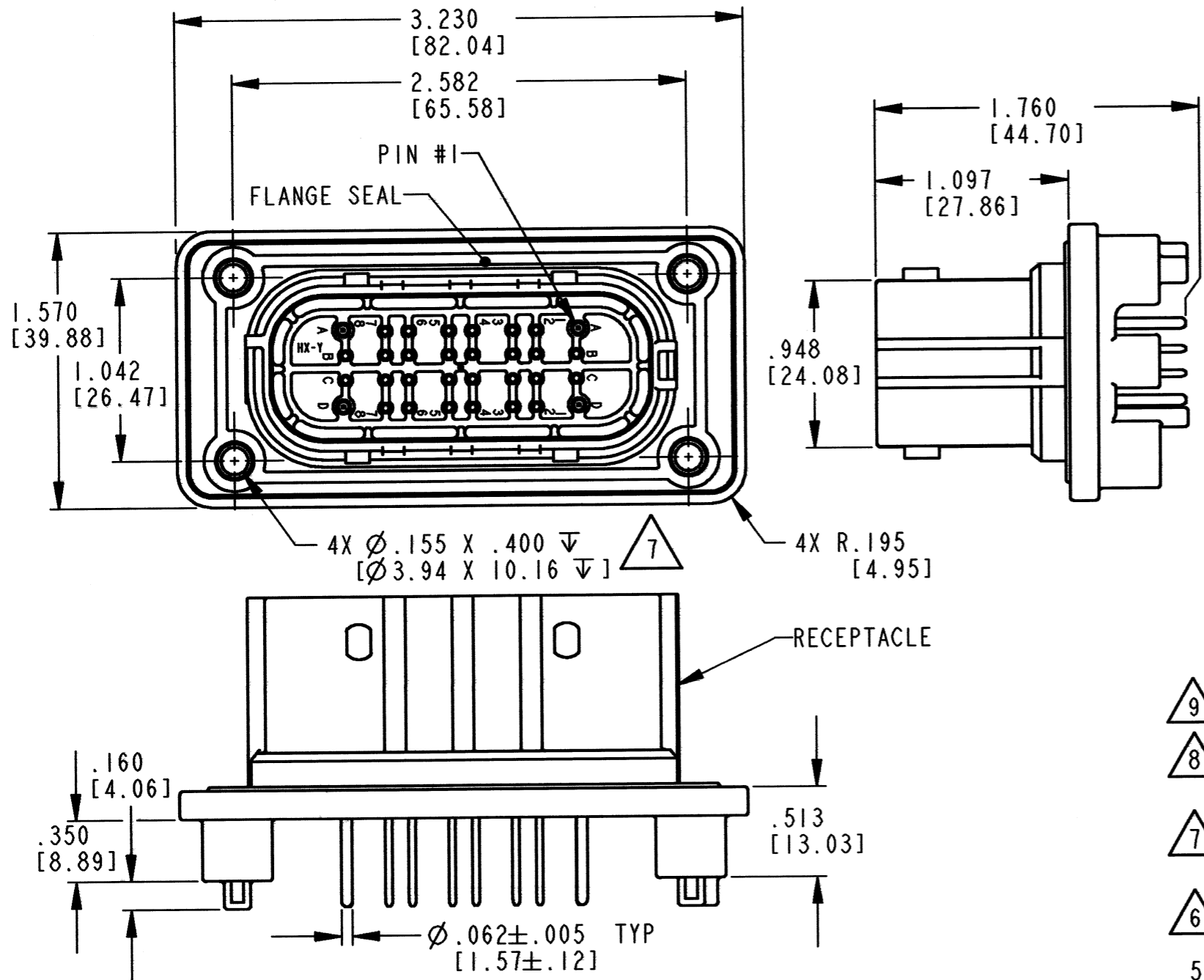

- (9) SURFACE FINISH: 32 RMS OR BETTER; $\square .005$ [.12]
- (8) RECOMMENDED MOUNTING SCREWS: CAMCAR PT THREAD FORMING FASTENER #K40, TORQUE TO 10-20 IN-LB [1.13-2.26 N-M].
- (7) RECOMMENDED MOUNTING SCREWS: CAMCAR PT THREAD FORMING FASTENER #K50, TORQUE TO 10-20 IN-LB [1.13-2.26 N-M].
- (6) SEE SHEETS 2, 3 & 4 FOR OTHER KEY ARRANGEMENTS.

5. THIS RECEPTACLE MATES WITH SRK06-MD*-32A-**** PLUG (*=A,B,C,D,E,F,G,H,I,J; ****=ALL MODIFICATIONS).

- 4. CONTACT PLATING - MATING SIDE: GOLD; PCB SIDE: TIN.
 - 3. MATERIAL - PLASTIC (HOUSING: BLACK) SEALS: RUBBER.
 - 2. DIMENSION TOLERANCE: $\pm .025$ [.64]; PANEL CUTOUT: $\pm .010$ [.25].
 - 1. DIMENSIONS ARE IN INCHES [MM].
- NOTES: UNLESS OTHERWISE SPECIFIED

SIGNATURE & DATE		PCB RECEPTACLE 32 PIN COLOR: BLACK -G003 MOD SRK SERIES ENVELOPE	EP 194	MATL. CODE
DR	J. APOSTOL 21 JUN 2009		3850 INDUSTRIAL AVE. HEMET, CA 92545	
CHK	<i>Paul M. Cannon 6/27/2010</i>		DEUTSCH INDUSTRIAL	
PE	<i>Paul M. Cannon 6/27/2010</i>		B SRK15-MD*32A-001-G003	
APPD	<i>D. Meyer 6/25/10</i>		DWG SIZE	CODE 11139
SCALE	NONE	WT		

REV NC	SRK15-MD*32A-001-G003	REVISIONS			
		SYM	DESCRIPTION	DATE	APPROVED
		NC	SEE SHEET 1	6-28-10	RDR

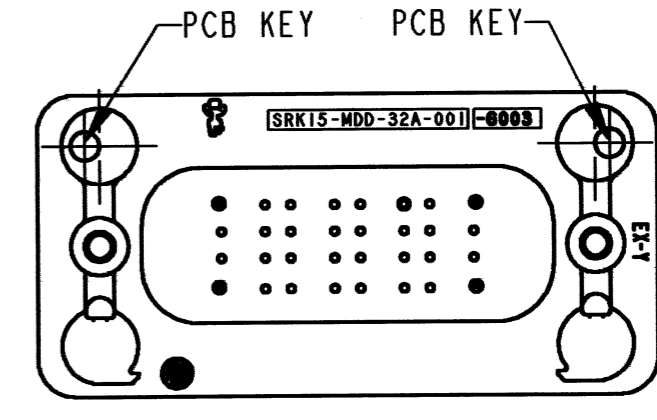
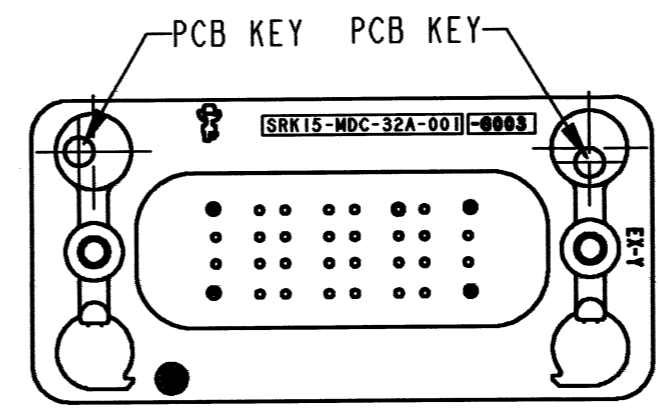
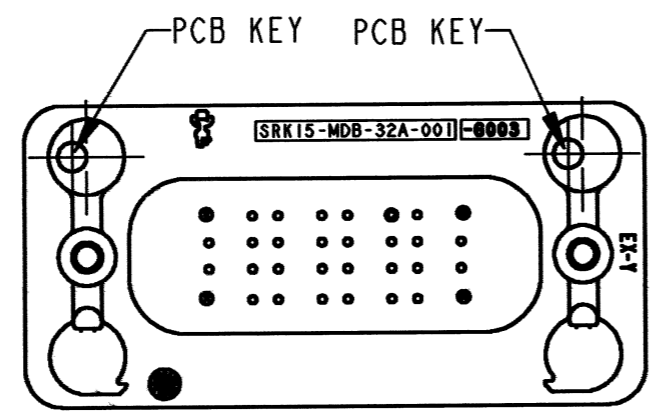
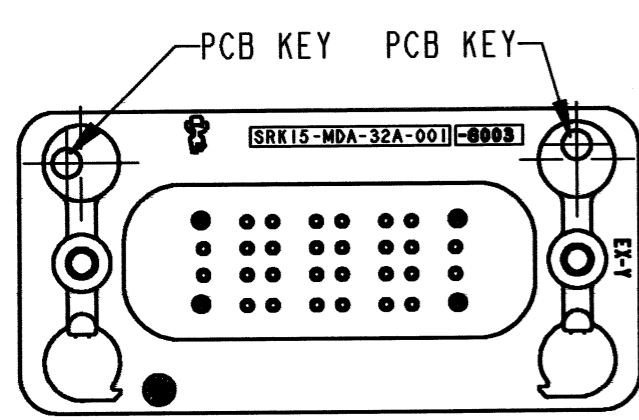
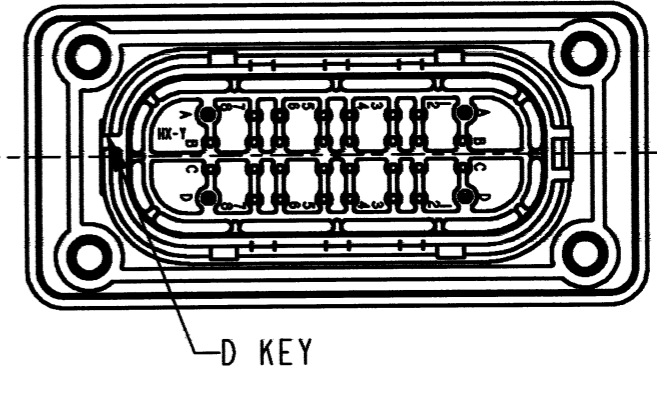
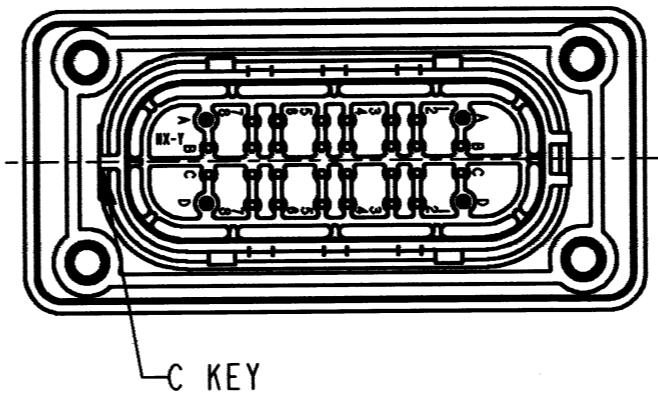
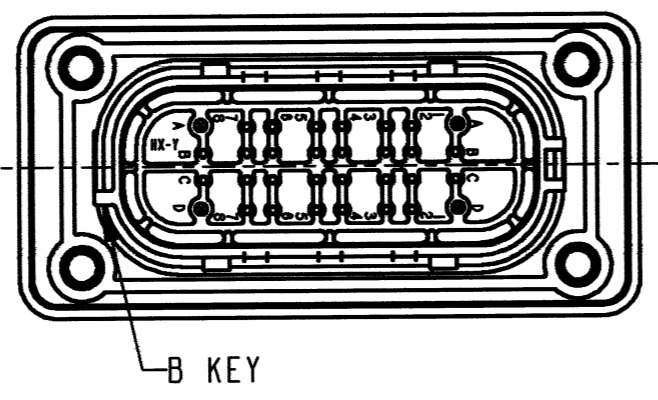
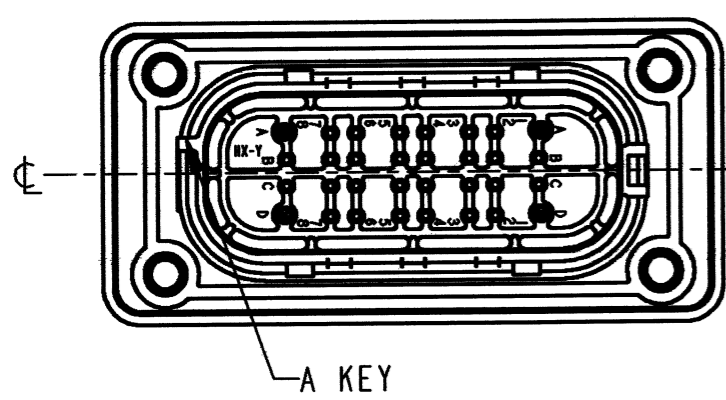

KEY ARRANGEMENT -A-
SRK15-MDA-32A-001-G003

KEY ARRANGEMENT -B-
SRK15-MDB-32A-001-G003

KEY ARRANGEMENT -C-
SRK15-MDC-32A-001-G003

KEY ARRANGEMENT -D-
SRK15-MDD-32A-001-G003

NOTES:

SIGNATURE & DATE		PCB RECEPTACLE 32 PIN COLOR: BLACK -G003 MOD SRK SERIES	EP 194	MATL. CODE
DR	J. APOSTOL 22 JUN 2009		3850 INDUSTRIAL AVE. HEMET, CA 92545	
CHK	<i>Paula McLaughlin</i> 6/24/10		DEUTSCH INDUSTRIAL	
PE	<i>Paula McLaughlin</i> 6/25/10		B SRK15-MD*32A-001-G003	
APPD	<i>D. Meyer</i> 6/25/10		DWG SIZE	CODE 11139
SCALE	NONE WT	ENVELOPE		

REV NC SRK15-MD*32A-001-G003

REVISIONS			
SYM	DESCRIPTION	DATE	APPROVED
Nc	SEE SHEET 1	6-28-16	<i>RDR</i>

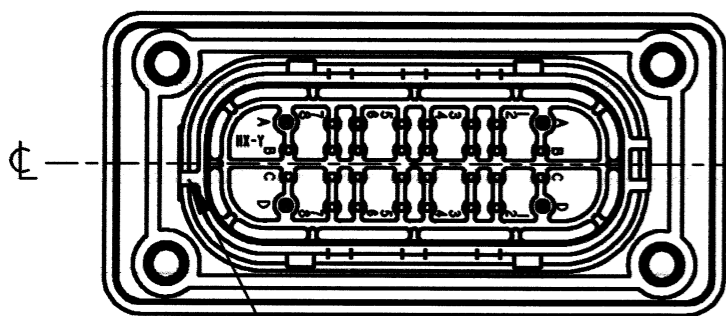

E KEY

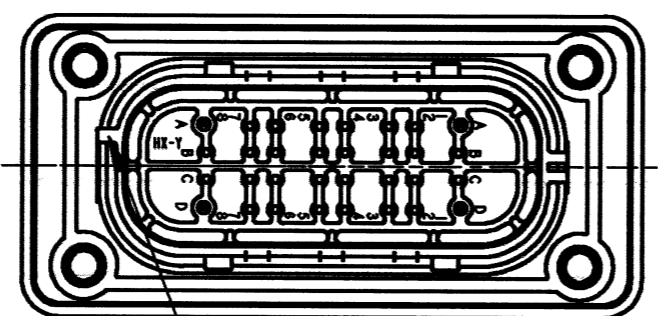

F KEY

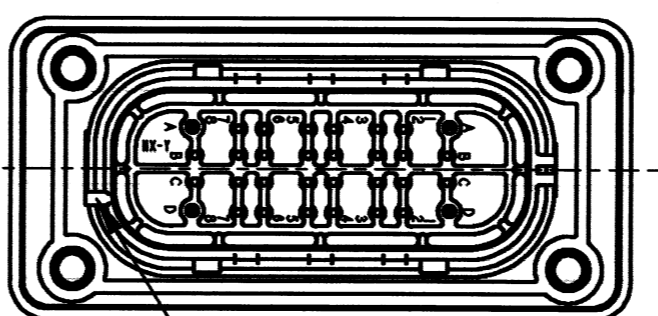

G KEY

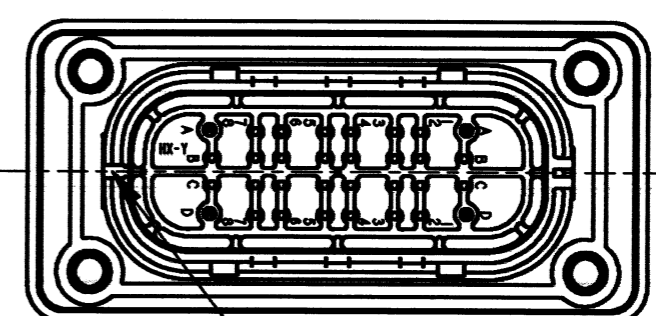

H KEY

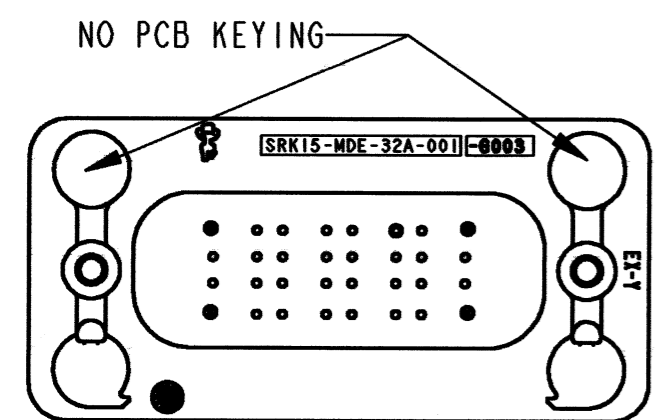

NO PCB KEYING

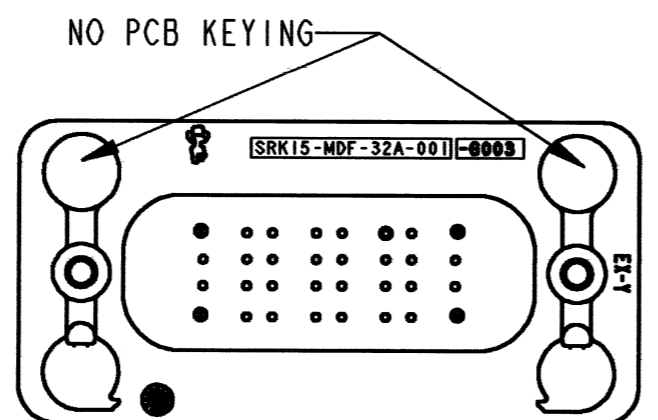

NO PCB KEYING

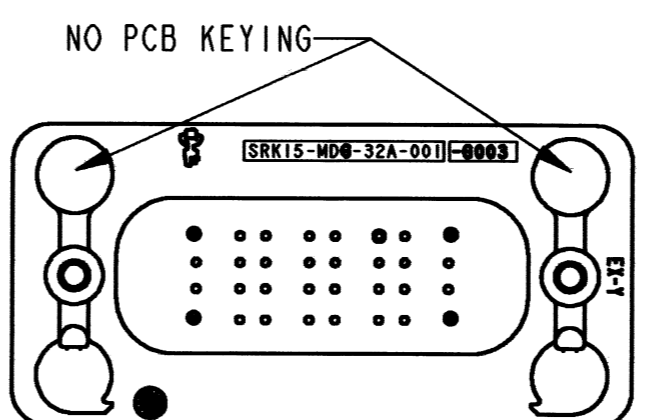

NO PCB KEYING

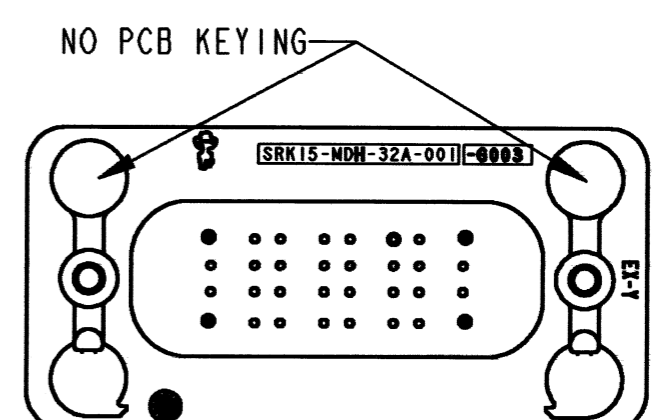

NO PCB KEYING

KEY ARRANGEMENT -E-
SRK15-MDE-32A-001-G003

KEY ARRANGEMENTS -F-
SRK15-MDF-32A-001-G003

KEY ARRANGEMENTS -G-
SRK15-MDG-32A-001-G003

KEY ARRANGEMENTS -H-
SRK15-MDH-32A-001-G003

NOTES:

SIGNATURE & DATE	
DR	<i>J. APOSTOL</i> 22 JUN 2009
CHK	<i>Paula M. Linnell</i> 6/23/2010
PE	<i>Paula M. Linnell</i> 6/25/2010
APPD	<i>D. Meyer</i> 6/25/10
SCALE	NONE WT

PCB RECEPTACLE
32 PIN
COLOR: BLACK
-G003 MOD
SRK SERIES

ENVELOPE

EP 194	MATL. CODE
 3850 INDUSTRIAL AVE. HEMET, CA 92545	
B SRK15-MD*32A-001-G003	
DWG SIZE	SHEET 3 OF 4

REV		REVISIONS		
NC	SYM	DESCRIPTION	DATE	APPROVED
NC		SEE SHEET 1	6-28-10	<i>DR</i>

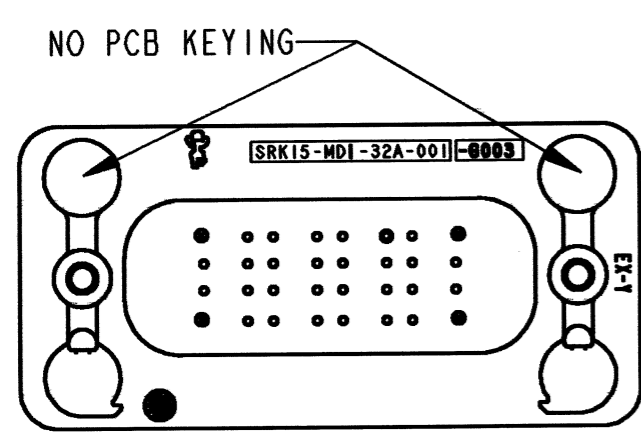
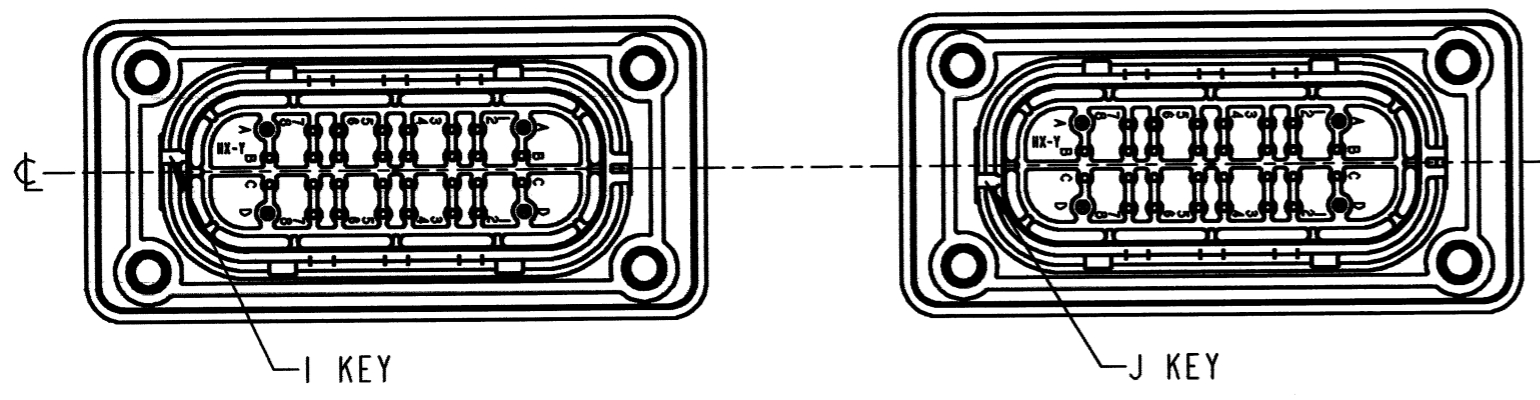

**KEY ARRANGEMENTS -I-
SRK15-MDI-32A-001-G003**

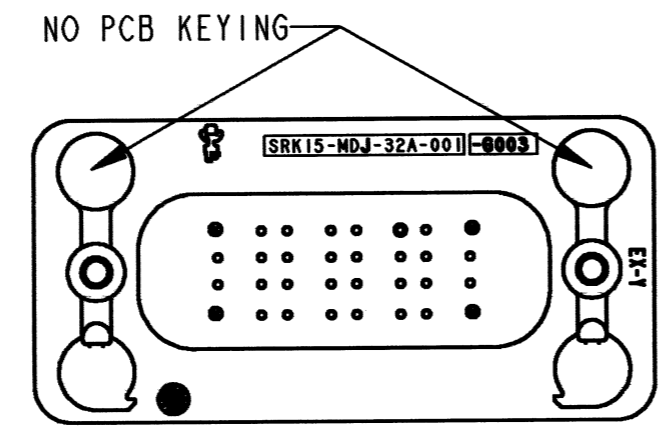

**KEY ARRANGEMENTS -J-
SRK15-MDJ-32A-001-G003**

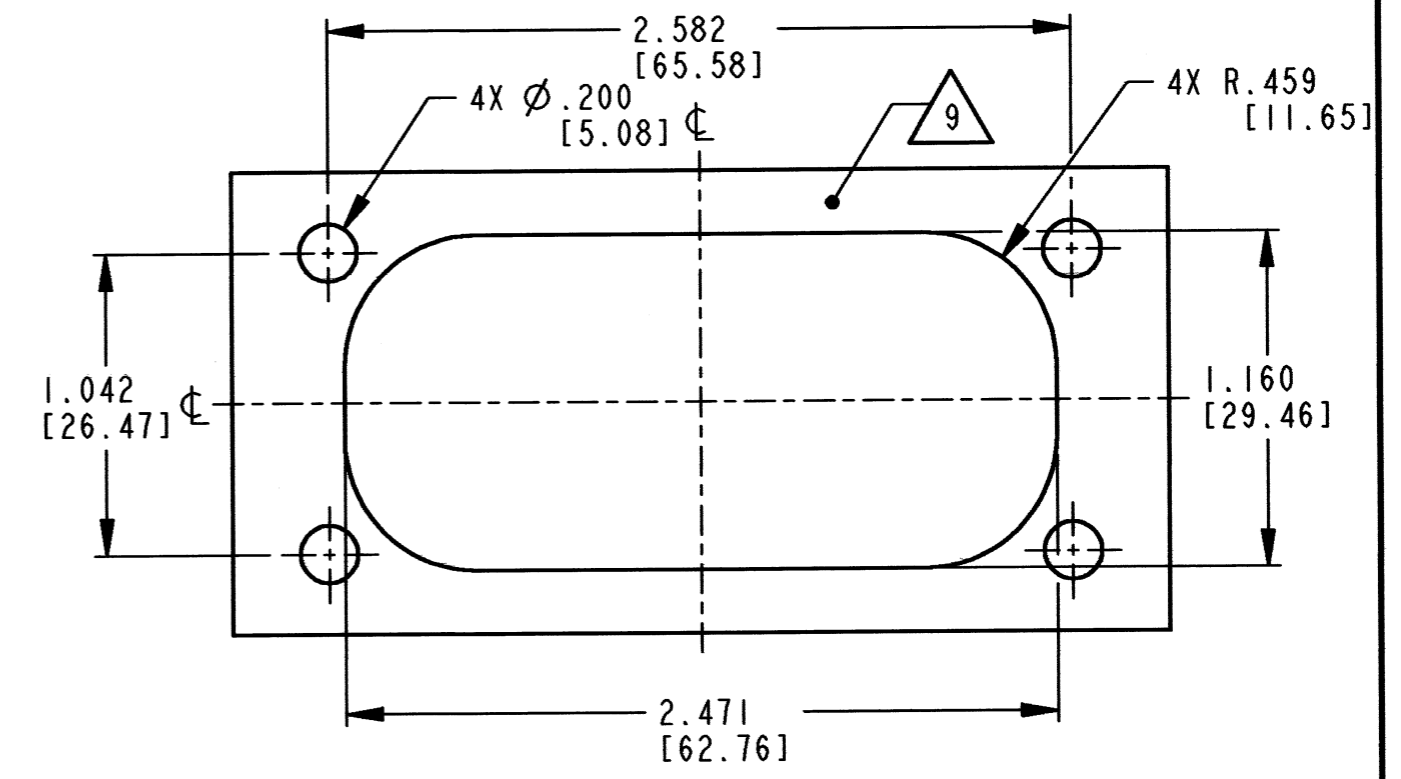

PANEL CUTOUT

NOTES:

SIGNATURE & DATE		PCB RECEPTACLE 32 PIN COLOR: BLACK -G003 MOD SRK SERIES ENVELOPE	EP 194	MATL. CODE
DR	<i>J. APOSTOL 22 JUN 2009</i>		3850 INDUSTRIAL AVE. HEMET, CA 92545	
CHK	<i>Paul Maiman 6/27/10</i>		DEUTSCH INDUSTRIAL	
PE	<i>Paul Maiman 6/27/10</i>		B SRK15-MD*32A-001-G003	
APPD	<i>D Meyer 6/25/10</i>		DWG SIZE	CODE 11139
SCALE	NONE	WT		