



INDUSTRIAL & COMMERCIAL TRANSPORTATION

Terminals and Connectors

Contents

General Information

About TE Connectivity	2
TE.com	3
Introduction to Connectors.....	4-5
Connector Series Overview.....	6-10

AMP Products

AMPSEAL Connectors	11-20
AMPSEAL 16 Connectors	21-34
Circular DIN Connectors.....	35-44
HDSCS Connectors.....	45-62
LEAVYSEAL Connectors	63-78
Superseal 1.0 Connectors.....	79-84

DEUTSCH Products

AEC Series	85-90
DRB Series	91-98
DRC Series	99-108
DT Family	109-132
HD10 Series	133-144
HD30 & HDP20 Series.....	145-160
STRIKE Series	161-168
Common Contacts.....	169-180
Tooling.....	181-190

Specialty Products

Bussing Options	191-194
Controller Area Networks	195-207
Diodes & Resistors.....	205-208
Printed Circuit Board Connectors	209-222
Single Terminal.....	223-228

Additional Resources

Modification List.....	230-238
Other TE Industrial & Commercial Transportation Products	239-240
Requirements & Standards.....	241
Glossary	242-247
Index	248-252

We go to extremes to make sure EVERY CONNECTION COUNTS.

TE Connectivity's (TE) products are in nearly every high-tech product imaginable. From consumer electronics, health care, energy supply, and communication networks, to the transportation and aviation industries, TE's extensive portfolio of over 500,000 products keep the world connected. TE's intelligent and robust solutions and technologies carry over to the industrial and heavy duty vehicle markets. TE offers products that work just as hard as the vehicles in which they are installed.



Years ago, tractors, construction equipment, trucks, and boats had simple electrical systems that might have included electrical starting and a basic lighting package. Today, ECUs, joysticks, fuel-efficient engines, LED lights, and CAN systems are standard equipment. The need to protect sensitive electrical systems from vibration, moisture, dust, dirt, salt and airborne particles has never been greater. TE Industrial & Commercial Transportation is a leader in supporting today's increasingly complex and sophisticated equipment and applications.

TE's comprehensive line of Industrial & Commercial Transportation products include an unparalleled portfolio of rugged electrical connector products and sensor technologies. TE's environmentally sealed connectors are designed to withstand the harshest environmental conditions and to keep vehicles moving forward. TE's portfolio of heavy duty sensors help vehicles operate safer, cleaner, and smarter.

From heavy duty trucks to construction equipment, mining vehicles to fire trucks, as well as boats, motorcycles, and tractors, leading manufacturers count on TE Industrial & Commercial Transportation.

Online Resources

The TE Connectivity Industrial & Commercial Transportation's website is an innovative and interactive source for application information, product updates, and technical solutions.



PRODUCT LITERATURE AND VIDEOS

TE Industrial & Commercial Transportation offers a variety of product specific catalogs, brochures, and videos to better serve you.

For more information on literature for TE Industrial & Commercial Transportation, please contact your representative or go to <http://www.te.com/usa-en/industries/truck-bus-off-road-vehicles/ictliterature.html>

To view videos about TE Industrial & Commercial Transportation, please go to <http://www.te.com/usa-en/industries/truck-bus-off-road-vehicles/ict-video-index.html>

TE INDUSTRIAL & COMMERCIAL TRANSPORTATION PRODUCTS

For more information on TE Industrial & Commercial Transportation products, please go to <http://www.te.com/usa-en/industries/truck-bus-off-road-vehicles/products.html>



PRODUCT INFORMATION CENTER (PIC)

You can rely on TE Connectivity's PIC team to provide support for answers to your general information or technical questions in an efficient and effective manner.

Connect with our PIC staff, <http://www.te.com/usa-en/customer-support/email.html>

Introduction to Connectors

In heavy industries, electrical systems must stand up to rigorous conditions and all weather environments. Failure in an electrical system can be expensive to diagnose and down equipment can stop entire operations. As equipment becomes increasingly sophisticated and reliant on electronic packaging and diagnostics, design engineers know the importance of choosing environmentally sealed electrical connectors capable of holding up to extreme conditions. Many manufacturers count on TE Connectivity Industrial & Commercial Transportation's electrical connectors to maintain their electrical connections.



Benefits of industrial connectors

There are many different connectors for harsh environments and connector selection for each specific application is important. Once the questions of wire gauge and pin count have been addressed, the environmental challenges specific to each application must be identified, including if the electrical system will be exposed to heat, impact or vibration. Other elements that need to be addressed include if the connectors will be susceptible to moisture or chemicals and field serviceability. Developed with simplicity of design and ease of use in mind, TE connectors offer a variety of innovative solutions to suit nearly any application and stand up to environmental challenges.

Whether for a new application or a retrofit, connectors provide simplified design and wiring, and easy field repairs. TE Industrial & Commercial Transportation's connector applications include ECUs, joysticks, industrial and marine engines, control boxes, lights and CAN systems, just to mention a few. TE Industrial & Commercial Transportation's connector series offer several features designed to combat environmental challenges.

Connector features help protect electrical connections

Connector bodies must be able to stand up to environmental conditions. Rugged all-metal bodies and corrosion resistant thermoplastic shells are manufactured from high quality materials selected for their ability to withstand years of environmental exposure. Metal connectors are built to withstand the force and shock of hard impacts that connectors face in rough environments. High-grade thermoplastic connectors are lightweight and are engineered to be flame resistant and extremely chemical resistant. Different connector body materials are available to meet diverse application requirements.

Introduction to Connectors

Proper contact alignment is another important aspect of environmentally sealed electrical connectors. Secondary locks snap into or onto the mating face of a connector to help confirm the contacts slide together properly when the connectors are mated. Many of TE Industrial & Commercial Transportation's connectors feature secondary locks that are commonly referred to as wedgelocks, terminal position assurance (TPA), or primary latch reinforcement (PLR). Wedgelocks, TPAs, and PLRs provide additional stability to both the contact barrel and the mated connectors.

A firm, secure locking mechanism that can withstand vibration and shock is critical to maintain a steadfast

connector engagement in rugged applications. TE Industrial & Commercial Transportation's connectors are held together by push-latches, threaded coupling rings, or tightened together by jackscrews. The locking mechanisms are easy to engage and disengage and give an audible or tactile signal when they are securely fastened. Once fastened, the locking mechanisms prevent disengagement due to vibration or impact.

Since even a small degradation in electrical connections can be critical to industrial vehicles, manufacturers are turning to TE Industrial & Commercial Transportation's environmentally sealed electrical connectors to keep their equipment running. Connectors are increasingly needed as industrial equipment becomes more complex and reliant on electronic control units, CAN systems, and on-board communications systems. With a wide variety of industrial electrical connectors, manufacturers can find a connector for nearly any application. No matter the environment, TE's industrial connectors provide the innovative solutions demanded by harsh conditions. TE's dedication to quality and innovation has created a unique system of easy-to-use connectors to simplify processes from start to finish.



Connector Series Overview

Connector Series Overview

TE Connectivity connectors offer different shapes, latching mechanisms, mounting styles, and materials to meet diverse application requirements and offer accessories to further expand the series' flexibility. Below is an overview of each connector series that highlights the cavity count, wire gauge, material, and locking mechanism style. For complete series information, please see the series section of the catalog.



AEC Series

- Accepts contact size 16 (13 amps)
- 14-20 AWG (2.00-0.50 mm²)
- 40 cavity arrangement
- In-line
- Square, thermoplastic housing
- Jackscrew for mating

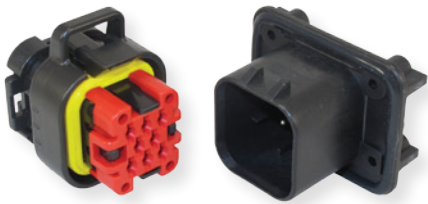

AMPSEAL Connectors

- Accepts contact size 1.3 mm (up to 17 amps gold, up to 8 amps tin)
- 16-20 AWG (1.25-0.50 mm²)
- 8, 14, 23, and 35 cavity arrangements
- PCB mount
- Rectangular, thermoplastic housing
- Integrated latch for mating
- Integrated wedgelock confirms contact alignment and retention
- Product specification documents: 108-1329 and 114-16016



AMPSEAL 16 Connectors

- Accepts contact size HDSF 16 (up to 13 amps)
- 14-20 AWG (2.00-0.50 mm²)
- 2, 3, 4, 6, 8, and 12 cavity arrangements
- In-line mount
- Rectangular, thermoplastic housing
- Integrated latch for mating
- Integrated Primary Latch Reinforcement (PLR) confirms contact alignment and retention
- Product specification documents: 108-2184, 114-13045, and 114-13065



Circular DIN Connectors

- Accepts contact size 2.5 mm (up to 40 amps)
- 2.50-0.20 mm²
- 2, 3, and 4 cavity arrangements
- In-line, flange, or PCB mount
- Circular, thermoplastic housing
- Coupling ring for mating
- Product specification documents: 108-18621 and 114-18255



DRB Series

- Accepts contact sizes 4 (100 amps), 8 (60 amps), 12 (25 amps), 16 (13 amps), and 20 (7.5 amps)
- 6-22 AWG (16.00-0.35 mm²)
- 48, 60, 102, and 128 cavity arrangements
- Flange mount
- Rectangular, thermoplastic housing
- Jackscrew for mating
- Wedgelocks confirm contact alignment and retention

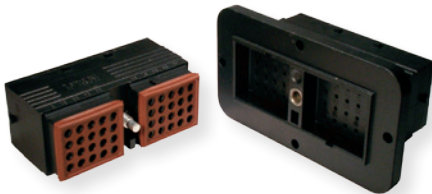

DRC Series

- Accepts contact sizes 16 (13 amps), and 20 (7.5 amps)
- 14-22 AWG (2.50-0.35 mm²)
- 24, 38, 40, 50, 60, 64, 70, and 76 cavity arrangements
- In-line, flange, or PCB mount
- Rectangular, thermoplastic housing
- Jackscrew for mating



DT Series

- Accepts contact size 16 (13 amps)
- 14-20 AWG (2.00-0.50 mm²)
- 2, 3, 4, 6, 8, and 12 cavity arrangements
- In-line, flange, or PCB mount
- Rectangular, thermoplastic housing
- Integrated latch for mating
- Wedgelocks confirm contact alignment and retention
- Product specification document: 108-151009



DTHD Series

- Accepts contact sizes 4 (100 amps), 8 (60 amps), and 12 (25 amps)
- 6-14 AWG (16.00-2.00 mm²)
- 1 cavity arrangement
- In-line or flange mount
- Circular, thermoplastic housing
- Integrated latch for mating

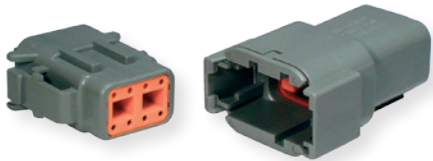

DTM Series

- Accepts contact size 20 (7.5 amps)
- 14-22 AWG (2.50-0.35 mm²)
- 2, 3, 4, 6, 8, and 12 cavity arrangements
- In-line, flange, or PCB mount
- Rectangular, thermoplastic housing
- Integrated latch for mating
- Wedgelocks confirm contact alignment and retention
- Product specification document: 108-151010

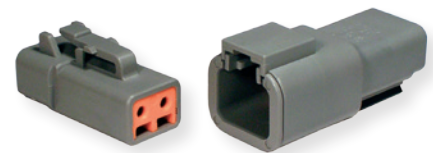

DTP Series

- Accepts contact size 12 (25 amps)
- 10-14 AWG (6.00-2.00 mm²)
- 2 and 4 cavity arrangements
- In-line, flange, or PCB mount
- Rectangular, thermoplastic housing
- Integrated latch for mating
- Wedgelocks confirm contact alignment and retention

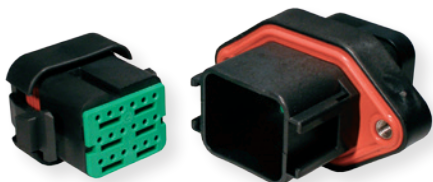

DTV Series

- Accepts contact size 16 (13 amps)
- 14-20 AWG (2.00-0.50 mm²)
- 18 cavity arrangement
- Flange mount
- Rectangular, thermoplastic housing
- Integrated latch for mating
- Wedgelocks confirm contact alignment and retention



HD10 Series

- Accepts contact sizes 4 (100 amps), 12 (25 amps), and 16 (13 amps)
- 6-20 AWG (16.00-0.50 mm²)
- 3, 4, 5, 6, and 9 cavity arrangements
- In-line, flange, or PCB mount
- Circular, thermoplastic housing
- Coupling ring for mating



HD30 Series

- Accepts contact sizes 4 (100 amps), 8 (60 amps), 12 (25 amps), 16 (13 amps), and 20 (7.5 amps)
- 6-22 AWG (13.00-0.35 mm²)
- 2, 6, 8, 9, 14, 16, 18, 19, 20, 21, 23, 29, 31, 33, 35, and 47 cavity arrangements
- In-line or flange mount
- Circular, aluminum housing
- Coupling ring for mating



HDP20 Series

- Accepts contact sizes 4 (100 amps), 8 (60 amps), 12 (25 amps), 16 (13 amps), and 20 (7.5 amps)
- 4-22 AWG (25.00-0.35 mm²)
- 2, 6, 7, 8, 9, 14, 16, 18, 19, 20, 21, 23, 29, 31, 33, 35, and 47 cavity arrangements
- In-line or flange mount
- Circular, thermoplastic housing
- Coupling ring for mating



HDSCS Connectors

- Accepts contact sizes 6.3 (up to 40 amps), 2.8 (up to 40 amps), and 1.5K (up to 20 amps)
- 6.00-0.20 mm²
- 2, 3, 4, 6, 7, 8, 10, 12, 15, 16, and 18 cavity arrangements
- In-line or flange mount
- Rectangular, thermoplastic housing
- Slide lock for mating
- Integrated secondary lock confirms contact alignment and retention
- Product specification documents: 108-94020 and 114-18756



LEAVYSEAL Connectors

- Accepts contact sizes 6.3 (up to 40 amps), 2.8 (up to 40 amps), and 1.5K (up to 20 amps)
- 6.00-0.20 mm²
- 15, 18, 21, 22, 26, 29, 31, 39, 46, 62, and 92 cavity arrangements
- In-line, flange, or PCB mount
- Rectangular, thermoplastic housing
- Lever for mating
- Integrated secondary lock confirms contact alignment and retention
- Product specification documents: 108-18696 and 114-18376

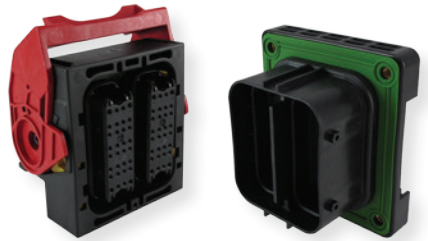

STRIKE Series

- Accepts contact sizes 16 (13 amps) and 20 (7.5 amps)
- 14-22 AWG (2.50-0.35 mm²)
- 32 and 64 cavity arrangements
- In-line, flange, or PCB mount
- Square, thermoplastic housing
- Lever for mating
- TPA confirms contact alignment and retention

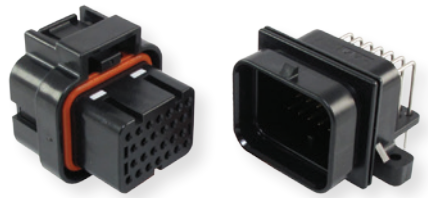

Superseal 1.0 Connectors

- Accepts contact size 1.0 mm (up to 15 amps)
- 1.25-0.50 mm²
- 26, 34, and 60 cavity arrangements
- PCB mount
- Rectangular, thermoplastic housing
- Integrated latch for mating
- TPA confirms contact alignment and retention
- Product specification documents: 108-78140 and 114-78011

Contents

AMPSEAL Connector Overview	12
Product Documentation	12
Performance Specifications	12
Material Specifications	13
Dimensions	13
Configurations	13
Ordering Information	14
Accessories	15
Contacts	15-16
Tooling	17
How To Instructions	18-19

AMPSEAL Connector Overview

AMPSEAL connectors provide rugged reliability and environmental sealing. They are available in cable plugs and PCB mount headers that are designed to stand up to high-temperature underhood applications. The pre-assembled receptacle housing connector features built-in contact sealing and an integral interfacial seal that protects mated connectors.



APPLICABLE PRODUCT DOCUMENTATION

Additional documentation is available for assistance with AMPSEAL connector products. The following TE Connectivity document numbers may be helpful:

54285-2 (Catalog Section)	408-3229 (Instruction Sheet)
108-1329 (Product Specification)	408-9592 (Instruction Sheet, Tooling)
114-16016 (Application Specification)	408-9999 (Instruction Sheet, Tooling)

AMPSEAL CONNECTOR PERFORMANCE SPECIFICATIONS

Current:	Up to 17 amps gold, up to 8 amps tin
Temperature:	Operating at temperatures -40°C to +125°C for gold plated, -40°C to +105°C for tin plated
Durability:	See <i>note</i> . Mate and unmate specimens for 10 cycles at maximum rate of 600 cycles per hour.
Physical Shock:	No discontinuities of 1 microsecond or longer duration. TE Spec 109-26-1. Subject mated specimens to 50 G's half-sine shock pulses of 11 milliseconds duration. Three shocks in each direction applied along 3 mutually perpendicular planes, 18 total shocks. See Fig 5 in TE product document 108-1329.
Insulation Resistance:	100 megohms minimum. TE Spec 109-28-4. Test between adjacent contacts of mated specimens.
Immersion:	Leakage current not to exceed 50 micro-amperes at 48 volts DC. TE Spec 109-74-5. Immerse specimens to a depth of 100 mm in 5% salt water at a temperature of $23 \pm 5^\circ \text{C}$ for 1 hour. Check between adjacent circuits and each surface to reference electrode.
Random Vibration:	See <i>note</i> . TE Spec 109-21-7, Condition G, except 10-500 Hz frequency range. Subject mated specimens to 10 Gs for 8 hours each plane.
Voltage:	250 volts AC

Note: Shall meet visual requirements, show no physical damage and shall meet requirements of additional tests as specified in Test Sequence in Figure 3 of TE product document 108-1329.

AMPSEAL Connectors

MATERIAL SPECIFICATIONS

- Wire Seal:** Silicone rubber
- Mating Seal:** Silicone rubber
- Cover:** Glass filled PBT
- Locking Wedge:** PBT

DIMENSIONS

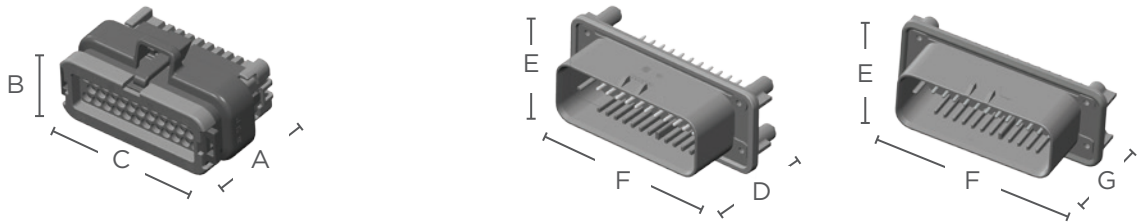

AMPSEAL Receptacle Housing

AMPSEAL Header

Cavity	Overall Length A	Overall Height B	Overall Width C	Overall Length Straight D	Overall Height E	Overall Width F	Overall Length 90° G
8	1.32 (33.6)	1.36 (34.6)	1.08 (27.4)	1.35 (34.3)	1.26 (32.1)	1.61 (40.8)	1.49 (37.9)
14	1.32 (33.6)	1.36 (34.6)	1.39 (35.4)	1.35 (34.3)	1.26 (32.1)	1.92 (48.8)	1.49 (37.9)
23	1.32 (33.6)	1.36 (34.6)	1.87 (47.4)	1.35 (34.25)	1.26 (32.1)	2.39 (60.8)	1.49 (37.9)
35	1.32 (33.6)	1.36 (34.6)	2.50 (63.4)	1.35 (34.25)	1.26 (32.1)	3.03 (76.9)	1.49 (37.9)

Dimensions are for reference only.

CONFIGURATIONS

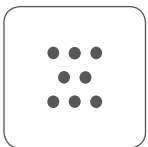

8 Positions
8 size 1.3 mm

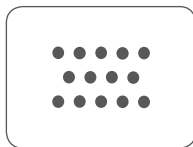

14 Positions
14 size 1.3 mm

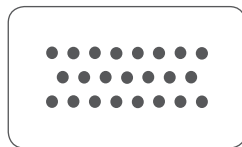

23 Positions
23 size 1.3 mm

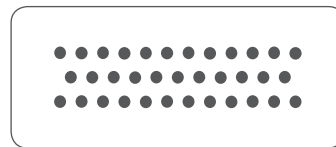

35 Positions
35 size 1.3 mm

ORDERING INFORMATION

Position	Keyed Housing Color	Contact Finish	Receptacle Housing	Right-Angle PCB Header		Vertical PCB Header	
				Without Seal	With Seal	Without Seal	With Seal
8	Black	Tin plated	776286-1	776279-1	776280-1	776275-1	776276-1
		Gold plated		1-776279-1	1-776280-1	1-776275-1	1-776276-1
	Natural	Tin plated	776286-2	776279-2	776280-2	776275-2	776276-2
		Gold plated		1-776279-2	1-776280-2	1-776275-2	1-776276-2
14	Black	Tin plated	776273-1	776266-1	776267-1	776261-1	776262-1
		Gold plated		1-776266-1	1-776267-1	1-776261-1	1-776262-1
	Natural	Tin plated	776273-2	776266-2	776267-2	776261-2	776262-2
		Gold plated		1-776266-2	1-776267-2	1-776261-2	1-776262-2
	Gray	Tin plated	776273-4	776266-4	776267-4	776261-4	776262-4
		Gold plated		1-776266-4	1-776267-4	1-776261-4	1-776262-4
	Blue	Tin plated	776273-5	776266-5	776267-5	776261-5	776262-5
		Gold plated		1-776266-5	1-776267-5	1-776261-5	1-776262-5
23	Black	Tin plated	770680-1	770669-1	776087-1	776200-1	776228-1
		Gold plated		1-770669-1	1-776087-1	1-776200-1	1-776228-1
	Natural	Tin plated	770680-2	770669-2	776087-2	776200-2	776228-2
		Gold plated		1-770669-2	1-776087-2	1-776200-2	1-776228-2
	Gray	Tin plated	770680-4	770669-4	776087-4	776200-4	776228-4
		Gold plated		1-770669-4	1-776087-4	1-776200-4	1-776228-4
	Blue	Tin plated	770680-5	770669-5	776087-5	776200-5	776228-5
		Gold plated		1-770669-5	1-776087-5	1-776200-5	1-776228-5
35	Black	Tin plated	776164-1	776180-1	776163-1	776230-1	776231-1
		Gold plated		1-776180-1	1-776163-1	1-776230-1	1-776231-1
	Natural	Tin plated	776164-2	776180-2	776163-2	776230-2	776231-2
		Gold plated		1-776180-2	1-776163-2	1-776230-2	1-776231-2
	Gray	Tin plated	776164-4	776180-4	776163-4	776230-4	776231-4
		Gold plated		1-776180-4	1-776163-4	1-776230-4	1-776231-4
	Blue	Tin plated	776164-5	776180-5	776163-5	776230-5	776231-5
		Gold plated		1-776180-5	1-776163-5	1-776230-5	1-776231-5
Orange	Gold plated	776164-6	1-776180-6	1-776163-6	-	1-776231-6	

AMPSEAL Connectors

WIRE SEALING RANGE

The wire sealing range is the recommended outside diameter of the wire insulation required to maintain an environmental seal in the rear connector cavities.

Contact Size	Standard Seal
1.3 mm 16-20 AWG (1.5-0.5mm ²)	.067-.106 (1.7-2.7)

Accessories

Wire relief is available as an accessory for the AMPSEAL 23 and 35 positions connectors. The wire relief offers a high level of protection and helps reduce strain from the wires.

WIRE RELIEF



Positions	Part Number	Description
23	776464-1 (one half, two halves required per receptacle housing)	Vertical, sealed receptacle housing wire relief (accepts no. 4 self-tapping screw)
35	776463-1 (one half, two halves required per receptacle housing)	Vertical, sealed receptacle housing wire relief (accepts no. 4 self-tapping screw)

Contacts

The AMPSEAL connectors commonly use the 1.3 mm three contact beam lanceless stamped & formed contact system.

1.3 MM CONTACT PERFORMANCE SPECIFICATIONS

Durability

TE Spec 109-27. Mate and unmate specimens for 10 cycles at maximum rate of 600 cycles per hour. See *note*.

Current Rating

Up to 17 amps gold, up to 8 amps tin, consult TE product document 108-1329.

Contact Retention

TE Spec 109-30. Apply an axial load of 115 N to contacts in the axial direction with wedge lock in locked position. Contacts shall not dislodge.

Crimp Tensile Strength

Contact Size	Tensile Strength
Size 20	80 lbs
Size 18	90 lbs
Size 16	150 lbs

Note: Shall meet visual requirements, show no physical damage and shall meet requirements of additional tests as specified in Test Sequence in Figure 3 of TE product document 108-1329.

AMPSEAL Connectors

1.3 MM STAMPED & FORMED CONTACTS FOR AMPSEAL

Size	Receptacle Part Numbers				Wire Size AWG (mm ²)	Insulation Diameter (mm)	Finish
	Strip Form	Package Quantity	Loose Piece	Package Quantity			
1.3 mm	770520-1	5000	770854-1	1000	16-20 (1.5-0.5)	.067-.106 (1.7-2.7)	Pre-tin plated
	770520-3	5000	770854-3	1000			Selective gold plated

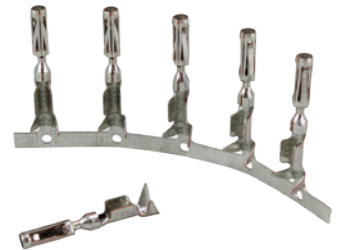

SEALING PLUGS

Open cavities provide pathways for contaminants to enter the connectors. To maintain seal integrity, any unused cavity that has been pierced must be filled with the appropriate size sealing plug.



Color	Part Number	Contact Size	Wire Gauge Range	Material
White	770678-1	1.3 mm	16-20 AWG	Nylon

AMPSEAL Connectors

Tooling

Tools are specific to the contact style. To create a proper crimp and achieve the highest performance specifications, contacts must be crimped with the recommended tooling.

HAND TOOLS FOR 1.3 MM CONTACTS



PRO-CRIMPER III CERTI-CRIMP II

Receptacle Strip Form	Receptacle Loose Piece	Tool P/N	Description
770520-1 770520-3	770854-1 770854-3	58529-1	PRO-CRIMPER III hand tool and die set assembly
		2217748-1	CERTI-CRIMP II straight action hand tool

Note: Base PRO-CRIMPER III tool part number with -2 suffix is the part number for the die set, which can be ordered separately

AUTOMATED TOOLING FOR 1.3 MM CONTACTS



Receptacle Strip Form	Applicator P/N	Description
770520-1 770520-3	2151376-1	OCEAN end feed applicator with mechanical feed
	2151376-2	OCEAN end feed applicator with pneumatic feed

Note: Applicators with additional feed styles are available, contact your representative

How To Instructions

CONTACT INSERTION

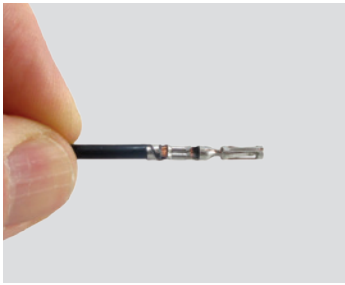

Step 1:
Grasp crimped contact approximately one inch behind the contact barrel.

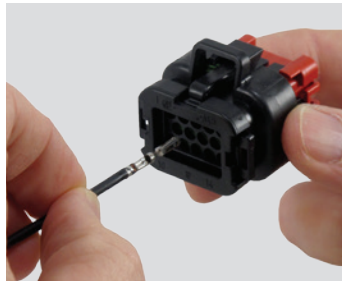

Step 2:
Check that the wedgelock of the plug assembly is in open position. Align the contact with the applicable cavity.

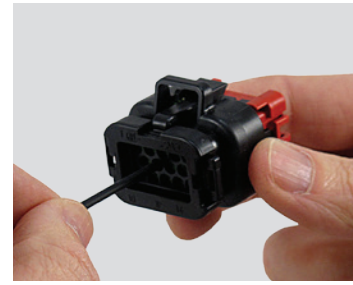

Step 3:
Insert the contact into the connector cavity until there is an audible and tactile click. A slight tug will verify the contact is locked in place.

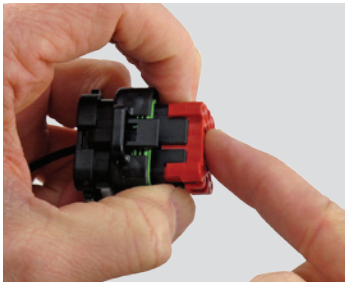

Step 4:
After all the contacts have been inserted, close the wedgelock by simultaneously squeezing locking latches inward and pushing the wedgelock into the housing.

Note

AMPSEAL connector grommet is solid until pierced.

CONTACT REMOVAL

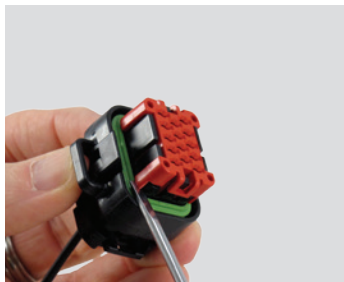

Step 1:
Insert the tip of a screwdriver (2-5mm wide blade) between the edge of the plug assembly housing and one corner of the wedgelock.



Step 2:
Gently pry the edge of the wedgelock until it is released from (but not completely removed) the housing. Repeat these steps for the opposite corner of the wedge.

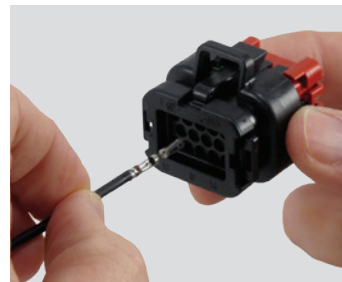

Step 3:
Gently pull the wire of the contact to be removed while rotating the wire (a quarter turn each direction) back and forth until the contact is removed from the housing.

NOTES:

Contents

AMPSEAL 16 Connector Overview	22
Product Documentation	22
Performance Specifications	22
Material Specifications	23
Dimensions	23
Configurations	23
Ordering Information	24
Accessories	25-26
AMPSEAL 16 Hybrid Lever	27-28
Contacts	29-30
Tooling	31-32
How To Instructions	33-34

AMPSEAL 16 Connectors

AMPSEAL 16 Connector Overview

The AMPSEAL 16 connector system is targeted for off-road, heavy duty industrial, recreational and agricultural applications. This wire-to-wire and wire-to-device connector line was designed to meet the rigorous demands of an industry that requires the highest standards in performance.

AMPSEAL 16 receptacle and pin housings offer a one-piece approach and come fully assembled.



APPLICABLE PRODUCT DOCUMENTATION

Additional documentation is available for assistance with AMPSEAL 16 products. The following TE Connectivity document numbers may be helpful:

1654281-2 (Catalog Section)

108-2184 (Product Specification)

114-13065 (Application Specification)

114-13045 (Application Specification, Contacts)

408-8623 (Instruction Sheet)

501-708 (Qualification Test Report)

AMPSEAL 16 CONNECTOR PERFORMANCE SPECIFICATIONS

Current:	Up to 13 amps
Temperature:	Operating at temperatures -40°C to +125°C
Durability:	<i>See note.</i> 50 cycles.
Insulation Resistance:	20 megohms minimum. SAE J2030 6.3. Insulation resistance at 1000 volts DC adjacent terminals measured after 60 seconds or until stabilization occurs.
Immersion:	IP67 rating
Random Vibration:	No discontinuities. <i>See note.</i> EIA-364-28 Subject mated specimens to 21 G's rms between 25 to 2000 Hz. Twenty hours in each of three mutually perpendicular planes.
Voltage:	250 volts DC

Note: Shall meet visual requirements, show no physical damage, and meet requirements of additional tests as specified in Product Qualification and Requalification Test Sequence in Figure 3 of TE product document 108-2184.

AMPSEAL 16 Connectors

MATERIAL SPECIFICATIONS

Wire Seal:	Silicone rubber
Plug Peripheral Seal:	Silicone rubber
Housing	15% Glass filled thermoplastic
CPA:	15% Glass filled thermoplastic
PLR:	15% Glass filled thermoplastic

DIMENSIONS

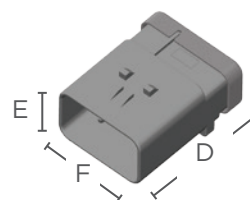
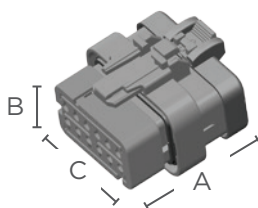

AMPSEAL 16 Receptacle Housing

AMPSEAL 16 Cap

Cavity	Overall Length A	Overall Height B	Overall Width C	Overall Length D	Overall Height E	Overall Width F
2	1.45 (36.75)	.93 (23.5)	.80 (20.33)	1.87 (47.55)	.75 (18.93)	.77 (19.60)
3	1.45 (36.80)	.93 (23.5)	.98 (24.83)	1.87 (47.55)	.75 (19.15)	.95 (24.10)
4	1.44 (36.70)	1.06 (26.8)	1.00 (25.33)	1.87 (47.55)	.88 (22.45)	.97 (24.60)
6	1.44 (36.60)	1.22 (31.0)	1.00 (25.33)	1.87 (47.55)	1.05 (26.65)	.97 (24.60)
8	1.45 (36.80)	1.24 (31.5)	1.15 (29.33)	1.87 (47.55)	1.05 (26.65)	1.13 (28.60)
12	1.45 (36.80)	1.24 (31.5)	1.51 (38.33)	1.87 (47.55)	1.05 (26.65)	1.48 (37.60)

Dimensions are for reference only.

CONFIGURATIONS



2 Positions
2 size 16



3 Positions
3 size 16



4 Positions
4 size 16

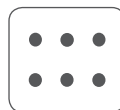

6 Positions
6 size 16

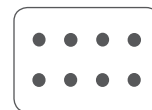

8 Positions
8 size 16

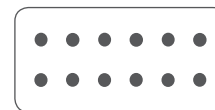

12 Positions
12 size 16

AMPSEAL 16 Connectors

ORDERING INFORMATION

Position	PLR Color	Keying	Receptacle Housing		Receptacle Housing	
			Standard Dia. Seal	Cap Standard Dia. Seal	Reduced Dia. Seal	Cap Reduced Dia. Seal
2	Red	Key A	776427-1	776428-1	776522-1	776534-1
	Gray	Key B	776427-2	776428-2	776522-2	776534-2
	Yellow	Key C	776427-3	776428-3	776522-3	776534-3
	Green	Key D	776427-4	776428-4	776522-4	776534-4
3	Red	Key A	776429-1	776430-1	776523-1	776535-1
	Gray	Key B	776429-2	776430-2	776523-2	776535-2
	Yellow	Key C	776429-3	776430-3	776523-3	776535-3
	Green	Key D	776429-4	776430-4	776523-4	776535-4
4	Red	Key A	776487-1	776488-1	776524-1	776536-1
	Gray	Key B	776487-2	776488-2	776524-2	776536-2
	Yellow	Key C	776487-3	776488-3	776524-3	776536-3
	Green	Key D	776487-4	776488-4	776524-4	776536-4
6	Red	Key A	776433-1	776434-1	776531-1	776537-1
	Gray	Key B	776433-2	776434-2	776531-2	776537-2
	Yellow	Key C	776433-3	776434-3	776531-3	776537-3
8	Red	Key A	776494-1	776495-1	776532-1	776538-1
	Gray	Key B	776494-2	776495-2	776532-2	776538-2
	Yellow	Key C	776494-3	776495-3	776532-3	776538-3
	Green	Key D	776494-4	776495-4	776532-4	776538-4
12	Red	Key A	776437-1	776438-1	776533-1	776539-1
	Gray	Key B	776437-2	776438-2	776533-2	776539-2
	Yellow	Key C	776437-3	776438-3	776533-3	776539-3
	Green	Key D	776437-4	776438-4	776533-4	776539-4

Receptacle housing and cap PLR colors are mechanically keyed to mate only with identical colors.

Part Number Suffix:

- 1 = A key (**red PLR**)
- 2 = B key (**gray PLR**)
- 3 = C key (**yellow PLR**)
- 4 = D key (**green PLR**)

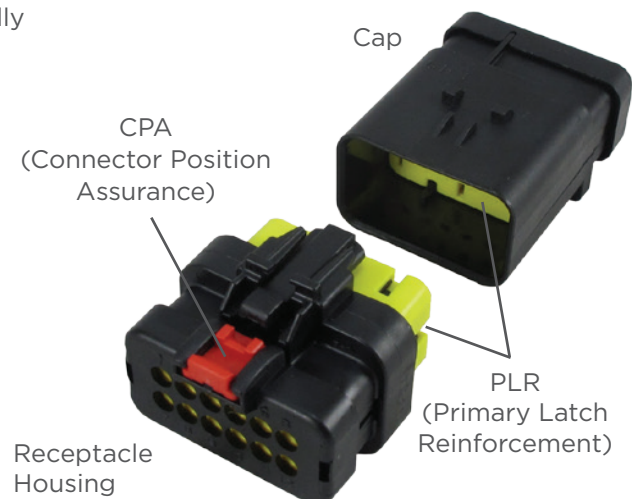

AMPSEAL 16 Connectors

WIRE SEALING RANGE

The wire sealing range is the recommended outside diameter of the wire insulation required to maintain an environmental seal in the rear connector cavities.

Contact Size	Standard Seal	Reduced Diameter Seal
HDSF 16 14-20 AWG (2.0-0.5mm ²)	.086-.144 (2.18-3.67)	.051-.100 (1.30-2.54)

Accessories

Backshells and mounting clips are accessory items available for use with AMPSEAL 16 connectors. These accessories cover design requirements by assisting with mounting, providing additional protection, and offering increased aesthetics.

BACKSHELLS



Part Numbers

Number of Positions	Conduit Size	Standard Straight	Standard 90°	Low Profile 90° Rec. Housing	Low Profile 90° Pin Housing
2	NC08/NW7.5	2035047-1 [†]	2035048-1 [†]	2035366-1	2098436-1
	NC12/NW10	-	2035048-5 [†]	2035366-3	2098436-3
3	NC08/NW7.5	2035047-2 [†]	2035048-2 [†]	2035366-2	2098436-2
	NC12/NW10	-	2035048-6 [†]	2035366-4	2098436-4
4	NC08/NW7.5	2035047-3 [†]	2035048-3 [†]	2035366-7	2098436-7
	NC12/NW10	2035047-5 [†]	2035048-7 [†]	2035366-9	2098436-9
	NC16/NW13	-	-	1-2035366-1	1-2098436-1
6	NC08/NW7.5	2035047-4 [†]	-	2035366-8	2098436-8
	NC12/NW10	2035047-6 [†]	-	1-2035366-0	1-2098436-0
	NC16/NW13	-	-	1-2035366-2	1-2098436-2
8	NC12/NW10	2035047-7 [†]	-	-	-
	NC16/NW13	2035047-9 [†]	2035047-9 [†]	-	-
12	NC12/NW10	2035047-8 [†]	-	-	-
	NC16/NW13	1-2035047-0 [†]	-	-	-
	NC20/NW17	1-2035047-1 [†]	-	-	-

[†] = Backshell available only with latch window. Can be used for cap assembly if desired.

AMPSEAL 16 Connectors

BACKSHELLS - NEXT GENERATION

Number of Positions	Conduit Size	Plug Part Numbers		Cap Part Numbers	
		Straight Backshell Part Number	90° Adapter Part Number	Straight Backshell Part Number	90° Adapter Part Number
2	Smooth	2292797-1	2292849-1	2292860-1	2292849-1
	NC12/NW10	2292797-2	2292849-2	2292860-2	2292849-2
	NC08/NW7.5	2292797-3	2292849-3	2292860-3	2292849-3
3	Smooth	2292798-1	2292849-1	2292861-1	2292849-1
	NC12/NW10	2292798-2	2292849-2	2292861-2	2292849-2
	NC08/NW7.5	2292798-3	2292849-3	2292861-3	2292849-3
4	Smooth	2292799-1	2292850-1	2292862-1	2292850-1
	NC16/NW13	2292799-2	2292850-2	2292862-2	2292850-2
	NC12/NW10	2292799-3	2292850-3	2292862-3	2292850-3
6	Smooth	2292800-1	2292850-1	2292863-1	2292850-1
	NC16/NW13	2292800-2	2292850-2	2292863-2	2292850-2
	NC12/NW10	2292800-3	2292850-3	2292863-3	2292850-3
8	Smooth	2292801-1	2292851-1	2292864-1	2292851-1
	NC20/NW17	2292801-2	2292851-2	2292864-2	2292851-2
	NC16/NW13	2292801-3	2292851-3	2292864-3	2292851-3
12	Smooth	2292802-1	2292851-1	2292865-1	2292851-1
	NC16/NW13	2292802-2	2292851-2	2292865-2	2292851-2
	NC12/NW10	2292802-3	2292851-3	2292865-3	2292851-3

Note: Expected availability December 2015, contact your representative

MOUNTING CLIPS



Part Number	Description
1924487-1	Mounting clip without anti-rotational feature
1924487-2	Mounting clip with anti-rotational feature

AMPSEAL 16 Connectors

AMPSEAL 16 Hybrid Lever Overview

The AMPSEAL 16 hybrid lever is a sealed connector system that features a lever slide mechanism for mating and a slide in mounting clip. The mix of 24 size 16 and 4 size 12 terminals creates design flexibility for use in various vehicle applications.



The tool-less mounting design, environmental protection, and temporary panel retention latches (which temporarily hold the connector in place for one person mounting through the panel) all reduce application cost and assembly time.

APPLICABLE PRODUCT DOCUMENTATION

Additional documentation is available for assistance with the AMPSEAL 16 hybrid lever product. The following TE Connectivity document numbers may be helpful:

108-32036 (Product Specification)
114-32117 (Application Specification)

501-32026 (Qualification Test Report)

DIMENSIONS

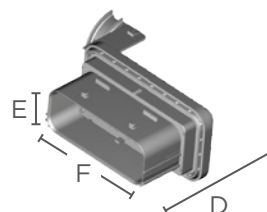
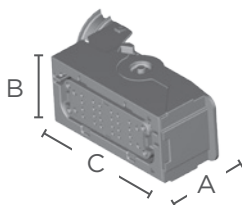

AMPSEAL 16 Hybrid Lever Receptacle Housing

AMPSEAL 16 Hybrid Lever Cap

Cavity	Overall Length A	Overall Height B	Overall Width C	Overall Length D	Overall Height E	Overall Width F
28	2.08 (52.95)	1.82 (46.25)	4.59 (116.5)	2.86 (72.75)	1.91 (48.45)	4.38 (111.25)

Dimensions are for reference only.

CONFIGURATION

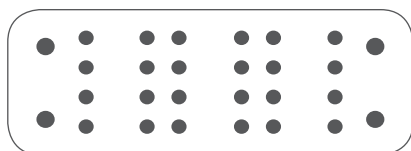

28 Positions

24 size 16, 4 size 12

AMPSEAL 16 Connectors

ORDERING INFORMATION

Position	Keying	Plug Housing	Cap Housing
28	Key A	2138839-1	2138846-1
	Key B	2138839-2	2138846-2

Accessories

Wire covers and mounting clips are accessory items available for use with AMPSEAL 16 hybrid lever connectors. These accessories cover design requirements by assisting with mounting and providing wire strain relief.

WIRE COVER



Part Number	Description
2138853-1	Wire cover for 28 position AMPSEAL 16 hybrid lever

MOUNTING CLIPS



Part Number	Description
2138852-1	Mounting clip, 5 mm panel
2138852-2	Mounting clip, 4 mm panel
2138852-3	Mounting clip, 3 mm panel

AMPSEAL 16 Connectors

Contacts

AMPSEAL 16 and AMPSEAL 16 hybrid lever connectors commonly use the HDSF size 16 contact system. The contacts are round, stamped & formed contacts with dual beam sockets.

HDSF 16 CONTACT PERFORMANCE SPECIFICATIONS

Durability

SAE J2030 6.11. 50 cycles. *See note.*

Current Rating

Up to 13 amps, consult TE product document 108-2184.

Contact Retention

IEC 512-8, Test 51a. Apply axial load of 111 N to contacts at a maximum rate of 10 N per second (or 50mm per minute) and hold for 10 seconds. Contacts shall not dislodge.

Crimp Tensile Strength

USCAR 21 @ 50mm/min

Wire Gauge	Tensile Strength
18 AWG	90 N Min
16 AWG	120 N Min
14 AWG	180 N Min

Voltage Drop

Contact Size	Test Current Amps	Voltage Drop (millivolts max)
18	8	100
16	10	100
14	13	100

Note: Shall meet visual requirements, show no physical damage, and meet requirements of additional tests as specified in the Product Qualification and Requalification Test Sequence in Figure 3 of TE product document 108-2184. USCAR is a trademark.

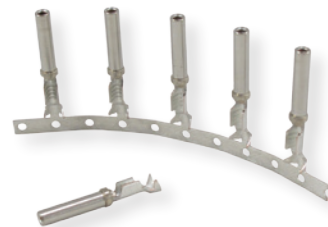

AMPSEAL 16 Connectors

HDSF 16 STAMPED & FORMED CONTACTS FOR AMPSEAL 16 CONNECTORS

Size	Pin Part Numbers				Wire Size AWG (mm ²)	Insulation Diameter (mm)	Wire Insulation Support	Finish
	Strip Form	Package Quantity	Loose Piece	Package Quantity				
HDSF 16	1924463-1	4000	1924579-1	1000	18-20 (0.8-0.5)	.107-.05 (2.72-1.27)	yes	Gold
	1924463-3	4000	1924579-3	1000				Nickel
	776349-1	4000	-	-	18-20 (0.8-0.5)	.131-.089 (3.33-2.26)	yes	Gold
	776349-3	4000	-	-				Nickel
	638078-1	4000	776300-1	1000	14-18 (2.0-0.8)	.131-.089 (3.33-2.26)	yes	Gold
	638078-3	4000	776300-2	1000				Nickel
	638112-1	4000	776298-1	1000	14-18 (2.0-0.8)	.155-0.077 (3.94-1.96)	no	Gold
	638112-3	4000	776298-2	1000				Nickel
	2098250-1	4000	-	-	18 (1.5-0.8)	.118-.065 (3.00-1.65)	yes	Gold
	2098250-3	4000	-	-				Nickel
	2098252-1	4000	-	-	14 (2.0-1.5)	.128-.083 (3.25-2.10)	yes	Gold
	2098252-3	4000	-	-				Nickel

Size	Receptacle Part Numbers				Wire Size AWG (mm ²)	Insulation Diameter (mm)	Wire Insulation Support	Finish
	Strip Form	Package Quantity	Loose Piece	Package Quantity				
HDSF 16	1924464-1	4000	1924580-1	1000	18-20 (0.8-0.5)	.107-.05 (2.72-1.27)	yes	Gold
	1924464-2	4000	1924580-2	1000				Nickel
	776493-1	4000	-	-	18-20 (0.8-0.5)	.131-.089 (3.33-2.26)	yes	Gold
	776493-2	4000	-	-				Nickel
	776492-1	4000	776299-1	1000	14-18 (2.0-0.8)	.131-.089 (3.33-2.26)	yes	Gold
	776492-2	4000	776299-2	1000				Nickel
	776491-1	4000	776297-1	1000	14-18 (2.0-0.8)	.155-.077 (3.94-1.96)	no	Gold
	776491-2	4000	776297-2	1000				Nickel
	2098251-1	4000	-	-	18 (1.5-0.8)	.118-.065 (3.00-1.65)	yes	Gold
	2098251-2	4000	-	-				Nickel
	2098253-1	4000	-	-	14 (2.0-1.5)	.128-.083 (3.25-2.10)	yes	Gold
	2098253-2	4000	-	-				Nickel

AMPSEAL 16 Connectors

SEALING PLUGS

Open cavities provide pathways for contaminants to enter the connectors. To maintain seal integrity, any unused cavity must be filled with the appropriate size sealing plug.



Color	Part Number	Contact Size	Wire Gauge Range	Description
Yellow	776363-1	Size 16	16-20 AWG	PBT, used with AMPSEAL 16 (standard diameter cavities)
White	776364-1	Size 20	16-20 AWG	PBT, used with AMPSEAL 16 (reduced diameter cavities)

Tooling

Tools are specific to the contact style. To create a proper crimp and achieve the highest performance specifications, contacts must be crimped with the recommended tooling.

HAND TOOLS FOR HDSF 16 CONTACTS



PRO-CRIMPER III

CERTI-CRIMP II

Pin Strip Form	Pin Loose Piece	Socket Strip Form	Socket Loose Piece	Tool P/N	Description
1924463-1 1924463-3	1924579-1 1924579-3	1924464-1 1924464-2	1924580-1 1924580-2	2119118-1	PRO-CRIMPER III hand tool and die set assembly
638078-1 638078-3 776349-1 776349-3	776300-1 776300-2	776492-1 776492-2 776493-1 776493-2	776299-1 776299-2	91337-1	PRO-CRIMPER III hand tool and die set assembly
638112-1 638112-3	776298-1 776298-2	776491-1 776491-2	776297-1 776297-2	2217753-1	CERTI-CRIMP II straight action hand tool

Note: Base PRO-CRIMPER III tool part number with -2 suffix is the part number for the die set, which can be ordered separately

AMPSEAL 16 Connectors

AUTOMATED TOOLING FOR HDSF 16 CONTACTS



OCEAN end
feed applicator



OCEAN side
feed applicator

Pin Strip Form	Socket Strip Form	Applicator P/N	Description
1924463-1 1924463-3	1924464-1 1924464-2	2151962-1	OCEAN end feed applicator with mechanical feed
		2151962-2	OCEAN end feed applicator with pneumatic feed
638078-1 638078-3 776349-1 776349-3	776492-1 776492-2 776493-1 776493-2	2151731-1	OCEAN end feed applicator with mechanical feed
		2151731-2	OCEAN end feed applicator with pneumatic feed
638112-1 638112-3	776491-1 776491-2	2151239-1	OCEAN end feed applicator with mechanical feed
		2151239-2	OCEAN end feed applicator with pneumatic feed
2098250-1 2098250-3	2098251-1 2098251-2	2151617-1	OCEAN end feed applicator with mechanical feed
		2151617-2	OCEAN end feed applicator with pneumatic feed
2098252-1 2098252-3	2098253-1 2098253-2	1530207-1	OCEAN side feed applicator that crops the terminal strip, for use in lead-maker
		1530207-2	OCEAN side feed applicator that crops the terminal strip, for use in bench press
		1530207-6	OCEAN side feed applicator that does not crop the terminal strip, for use in lead-maker

Note: Applicators with additional feed styles are available, contact your representative

EXTRACTION TOOL FOR HDSF 16 CONTACTS



Part Number	Description
776106-1	Contact extraction tool for HDSF 16 contacts

How To Instructions

CONTACT INSERTION

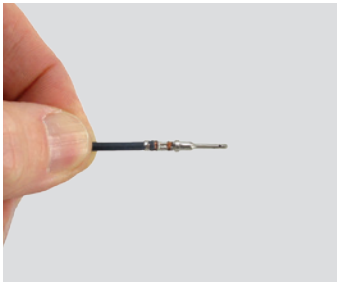

Step 1:
Grasp crimped contact approximately one inch behind the contact barrel.



Step 2:
Verify the PLR is in the pre-staged position, unlocked.



Step 3:
Align the contact with the desired circuit cavity at the rear of the housing assembly.



Step 4:
Push the contact straight into the connector cavity until the contact retention finger returns to its normal position behind the retention shoulder on the contact. A slight tug will verify the contact is locked in place.

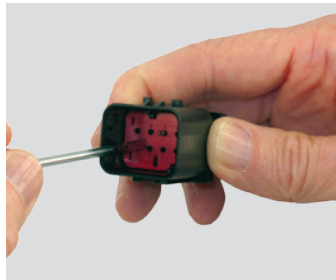

Step 5:
When all of the required contacts have been inserted, push the PLR into the fully locked position.

CONTACT REMOVAL

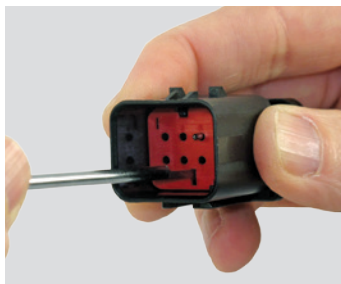

Step 1:
Insert the removal tool into the PLR extraction slot and pull until the PLR is completely removed from the housing.



Step 2:
Insert the tool into the contact cavity and deflect the contact retention finger.



Step 3:
Gently pull the wire until the contact is free from the housing.

Contents

Circular DIN Connector Overview	36
Product Documentation.....	36
Performance Specifications	36
Material Specifications.....	36
Dimensions	37
Configurations.....	37
Ordering Information.....	38
Accessories.....	38-39
Contacts	39-41
Tooling.....	42-44

Circular DIN Connectors

Circular DIN Connector Overview

The Circular DIN connectors are designed to meet the requirements of the DIN 72585/ISO 15170 standards. They feature a coupling ring for mating. Circular DIN connectors are suitable for in-line, flange mount, or PCB applications.



APPLICABLE PRODUCT DOCUMENTATION

Additional documentation is available for assistance with Circular DIN products. The following TE document numbers may be helpful:

1654286-3 (Catalog Section)

108-18621 (Product Specification)

114-18255 (Application Specification)

CIRCULAR DIN CONNECTOR PERFORMANCE SPECIFICATIONS

Current:	Up to 40 amps
Temperature:	Operating at temperatures -40°C to +120°C for plastic parts, short term up to +140°C defined in the standard ISO 15170
Durability:	20 cycles, max. testing requirement in the standard ISO 15170, former DIN 72585
Insulation Resistance:	No flash over or breakdown between every two contacts or between every contact and outer contour of the housing permitted at 1000 volts AC and 50 or 60 Hz for 60 seconds.
Immersion:	No ingress of water is allowed, acc. to DIN 40050-9 IPX7, IPX9K
Vibration:	According to standard ISO 15170, former DIN 72585
Dielectric Withstanding Voltage:	No flash over or breakdown between every two contacts or between every contact and outer contour of the housing permitted at 1000 volts AC and 50 or 60 Hz for 60 seconds.

MATERIAL SPECIFICATIONS

Flange Seal:	Silicone rubber
Housing:	Glass filled PBT and PA

Circular DIN Connectors

DIMENSIONS

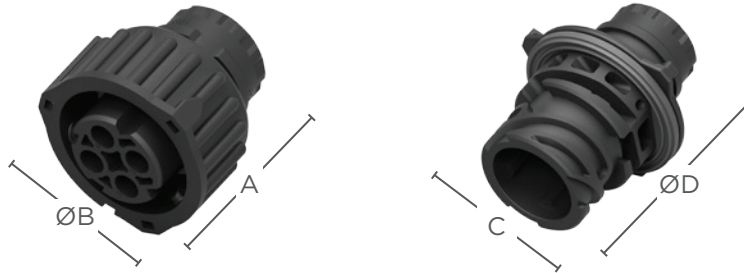

Circular DIN Socket Housing

Circular DIN Pin Housing

Cavity	Overall Length A	Overall Height ØB	Overall Length C	Overall Height ØD
2	1.22 (31.0)	1.29 (32.8)	1.73 (44.0)	1.34 (34.0)
3	1.22 (31.0)	1.29 (32.8)	1.73 (44.0)	1.34 (34.0)
4	1.22 (31.0)	1.29 (32.8)	1.73 (44.0)	1.34 (34.0)

Dimensions are for reference only.

CONFIGURATIONS

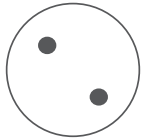

2 Positions
2 size 2.5 mm



3 Positions
3 size 2.5 mm

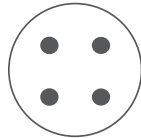

4 Positions
4 size 2.5 mm

Circular DIN Connectors

ORDERING INFORMATION

Position	Keying Type	Housing Color	Socket Housing	Pin Housing	PCB Header Vertical
2	1	Black	1-967325-3	1-967402-3	1394324-1 (tin)
			1-968968-3 (secondary locking)		
	2	Gray	2-967325-3	2-967402-3	-
			2-968968-3		-
3	Green	3-967325-3	-	-	
4	Blue	4-967325-3	-	-	
3	1	Black	1-967325-2	1-967402-2	1394324-4
			1-968968-2 (secondary locking)		
	2	Gray	2-967325-2	-	-
	3	Green	3-967325-2	-	-
4	Blue	4-967325-2	-	-	
4	1	Black	1-967325-1	1-967402-1	1241598-1 (no ventilation disk)
			1-968968-1 (secondary locking)		1394324-2 (tin)
					1394324-3 (gold)
			1703780-1 (ferrite disk)		
	2	Gray	2-967325-1	2-967402-1	-
	3	Green	3-967325-1	3-967402-1	-
4	Blue	4-967325-1	4-967402-1	-	

Accessories

Covers, backshells, and mounting rings are accessory items available for use with Circular DIN connectors. These accessories cover design requirements by assisting with mounting, providing additional protection, and offering increased aesthetics.

COVERS



Description	Color	Part Number
Front cover for socket housing 967325, suitable for IPX9K	Black	185636-1
Front cover for pin housing 967402, with ring		1394277-1
Front cover for pin housing 967402, without ring		1394277-2

Circular DIN Connectors

BACKSHELLS



Description	Color	Part Number
Right-angle adapter with universal clamp	Black	965576-1
Vertical adapter with universal clamp	Black	965784-1
Right-angle adapter for NW 7.5 mm diameter corrugated tubing	Black	185793-1
Right-angle adapter for NW 8.5 mm diameter corrugated tubing	Black	965577-1
Right-angle adapter for NW 10 mm diameter corrugated tubing	Black	965783-1
Vertical adapter for NW 7.5 mm diameter corrugated tubing	Black	185792-1
Vertical adapter for NW 8.5 mm diameter corrugated tubing	Black	965785-1
Vertical adapter for NW 10 mm diameter corrugated tubing	Black	965786-1
Right-angle adapter 4 position for hose	Black	1534789-1
Vertical adapter 4 position for hose	Black	1534791-1
Vertical adapter 4 position for jacketed cable 5.2-6.5 mm	Black	1418916-1
Vertical adapter 4 position for jacketed cable 6.0-9.5 mm	Black	1418917-1
Right-angle adapter 4 position for jacketed cable 5.2-6.5 mm	Black	1418918-1
Right-angle adapter 4 position for jacketed cable 6.0-9.5 mm	Black	1418919-1

MOUNTING RING

Description	Color	Part Number
Mounting ring for pin housing	Black	965687-1

Contacts

The Circular DIN connectors commonly use the 2.5 mm round, two-piece stamped & formed contact system.

2.5 MM CONTACT PERFORMANCE SPECIFICATIONS

Durability

Maximum mating cycles
 10 (tin)
 50 (silver)
 100 (gold)

Current Rating

Contact Size Max. Current
 2.5 mm up to 40 amps

Contact Retention(in housing)

Contact Size Min. Load
 2.5 mm > 90 N
 with secondary retention up to 100 N

Crimp Tensile Strength

Contact Size Tensile Strength
 .35 mm² ≥ 50 N
 .5 mm² ≥ 60 N
 1.0 mm² ≥ 100 N
 1.5 mm² ≥ 150 N
 2.5 mm² ≥ 200 N
 4.0 mm² ≥ 250 N

Circular DIN Connectors

2.5 MM STAMPED & FORMED CONTACTS FOR CIRCULAR DIN

Stamped & Formed Pins

Size	Pin Part Numbers				Wire Size (mm ²)	Insulation Diameter FLR (mm)	Finish
	Strip Form	Package Quantity	Loose Piece	Package Quantity			
2.5 mm	929963-1	3500	962967-1	500	0.5-1.0	1.4-2.1	Tin plated
	929963-8	3500	962967-8	500			Gold plated
	1-929963-0	3500	1-962967-0	500			
	929964-1	3500	962968-1	500	≥1.0-2.5	1.9-3.0	Tin plated
	1-929964-0	3500	1-962968-0	500			Gold plated
	929965-1	2500	962969-1	500	≥2.5-4.0	2.7-3.6	Tin plated

Stamped & Formed Pins with Single Wire Sealing System

Size	Pin Part Numbers				Wire Size (mm ²)	Insulation Diameter FLR (mm)	Finish
	Strip Form	Package Quantity	Loose Piece	Package Quantity			
2.5 mm	929966-1	3500	962970-1	500	0.2-0.4	1.2-2.1	Tin plated
	929966-7	3500	962970-7	500			Silver plated
	929967-1	3000	962971-1	500	0.5-1.0	1.2-2.1	Tin plated
	929967-4	3000	962971-4	500			
	929967-7	3000	962971-7	500			Silver plated
	1-929967-4	3000	1-962971-4	500			
	929967-8	3000	962971-8	500			Gold plated
	1-929967-0	3000	1-962971-0	500			
	929968-1	3000	962972-1	500	≥1.0-2.5	2.2-3.0	Tin plated
	929968-4	3000	962972-4	500			
	929968-7	3000	962972-7	500			Silver plated
	929968-8	3000	962972-8	500			Gold plated



Circular DIN Connectors

Stamped & Formed Sockets

Size	Socket Part Numbers				Wire Size (mm ²)	Insulation Diameter FLR (mm)	Finish
	Strip Form	Package Quantity	Loose Piece	Package Quantity			
2.5 mm	929969-1	3000	962976-1	500	0.2-0.4	1.15-1.6	Tin plated
	929970-1	3000	962977-1	500	0.5-1.0	1.4-2.1	Tin plated
	929970-7	3000	962977-7	500			Silver plated
	929970-8	3000	962977-8	500			Gold plated
	929971-1	3000	962978-1	500	≥1.0-2.5	1.9-3.0	Tin plated
	929971-7	3000	962978-7	500			Silver plated
	929971-8	3000	962978-8	500			Gold plated
	929972-1	3000	962979-1	500	≥2.5-4.0	2.7-3.0	Tin plated

Stamped & Formed Sockets with Single Wire Sealing System

Size	Socket Part Numbers				Wire Size (mm ²)	Insulation Diameter FLR (mm)	Finish
	Strip Form	Package Quantity	Loose Piece	Package Quantity			
2.5 mm	929973-1	3000	962980-1	500	0.2-0.4	1.2-2.1	Tin plated
	929974-1	3000	962981-1	500	0.5-1.0	1.2-2.1	Tin plated
	929974-4	3000	962981-4	500			Gold plated
	929974-8	3000	962981-8	500			Silver plated
	929974-7	3000	962981-7	500			
	1-929974-4	3000	1-962981-4	500	≥1.0-2.5	2.2-3.0	
	929975-1	3000	962982-1	500			Tin plated
	929975-4	3000	962982-4	500			
	929975-8	3000	962982-8	500			Gold plated
	929975-7	3000	962982-7	500			Silver plated



Circular DIN Connectors

WIRE SEALS

Wire seals are required for connectors without an integrated rear seal to maintain an environmental seal.

Contact Size	Insulation Diameter (mm)	Color	Part Number	Package Quantity
2.5 mm	1.2-2.1 FLR	Gray	828920-1	5000
	2.2-3.0 FLR	Violet	828921-1	

SEALING PLUGS

Open cavities provide pathways for contaminants to enter the connectors. To maintain seal integrity, any unused cavity must be filled with the appropriate size sealing plug.

Contact Size	Wire Size	Color	Part Number	Package Quantity
2.5 mm	up to 3.0 mm	Natural	828922-1	10,000
		Green	828922-2	
	up to 3.7 mm	Natural	828986-1	

Tooling

Tools are specific to the contact style. To create a proper crimp and achieve the highest performance specifications, contacts must be crimped with the recommended tooling.

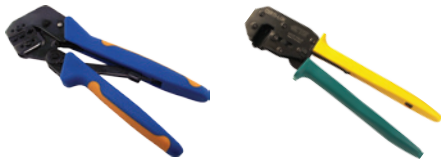

PRO-CRIMPER III

CERTI-LOK

HAND TOOL FOR 2.5 MM CONTACTS

Pin Strip Form	Pin Loose Piece	Socket Strip Form	Socket Loose Piece	Tool P/N	Description
1-929967-0 1-929967-4 929967-1 929967-4 929967-7 929967-8	1-926971-0 1-926971-4 962971-1 962971-4 962971-7 962971-8	1-929974-4 929974-1 929974-4 929974-7 929974-8 929975-1 929975-4 929975-7 929975-8	1-962981-4 962981-1 962981-4 962981-7 962981-8 962982-1 962982-4 962982-7 962982-8	58606-1	PRO-CRIMPER III hand tool and die set assembly
1-929964-0 929964-1	1-962968-0 962968-1	929971-1 929971-7 929971-7	962978-1 962978-7 962978-8	734285-2	CERTI-LOK hand tool with fixed die

Circular DIN Connectors

AUTOMATED TOOLING FOR 2.5 MM CONTACTS



OCEAN end
feed applicator



OCEAN side
feed applicator

Pin Strip Form	Socket Strip Form	Applicator P/N	Description
1-929963-0 929963-1 929963-8	929970-1 929970-7 929970-8	1426121-1	OCEAN side feed applicator that crops the terminal strip, for use in lead-maker
		1426121-2	OCEAN side feed applicator that crops the terminal strip, for use in bench press
		1426121-6	OCEAN side feed applicator that does not crop the terminal strip, for use in lead-maker
		1528689-1	OCEAN side feed applicator with fine adjust that crops the terminal strip, for use in lead-maker
		1528689-2	OCEAN side feed applicator with fine adjust that crops the terminal strip, for use in bench press
		1528689-6	OCEAN side feed applicator that does not crop the terminal strip, for use in lead-maker
929966-1 929966-7	929973-1	2151732-1	OCEAN end feed applicator with mechanical feed
		2151732-2	OCEAN end feed applicator with pneumatic feed
1-929964-0 929964-1	929971-1 929971-7 929971-8	2266503-1	OCEAN end feed applicator with mechanical feed
		2266503-2	OCEAN end feed applicator with pneumatic feed
929965-1	929972-1	1426425-1	OCEAN side feed applicator that crops the terminal strip, for use in lead-maker
		1426425-2	OCEAN side feed applicator that crops the terminal strip, for use in bench press
		1426425-6	OCEAN side feed applicator that does not crop the terminal strip, for use in lead-maker

Note: Applicators with additional feed styles are available, contact your representative

Circular DIN Connectors

AUTOMATED TOOLING FOR 2.5 MM CONTACTS (CONTINUED)

Pin Strip Form	Socket Strip Form	Applicator P/N	Description
1-929967-0 1-929967-4 929967-1 929967-4 929967-7 929967-8	1-929974-4 929974-1 929974-4 929974-7 929974-8	2151139-1	OCEAN end feed applicator with mechanical feed
		2151139-1	OCEAN end feed applicator with pneumatic feed
-	929975-1 929975-4 929975-7 929975-8	2151345-1	OCEAN end feed applicator with mechanical feed
		2151345-2	OCEAN end feed applicator with pneumatic feed

Note: Applicators with additional feed styles are available, contact your representative

EXTRACTION TOOL FOR 2.5 MM CONTACTS



Part Number	Description
1-1579007-8	Contact extraction tool for 2.5 mm contact system

Contents

HDSCS Connector Overview	46
Product Documentation.....	46
Performance Specifications	46
Material Specifications.....	47
Dimensions	47
Configurations.....	48
Ordering Information.....	49-50
Accessories.....	51-52
Contacts	53-55
Tooling.....	57-60
How To Instructions	60-61

HDSCS Connectors

HDSCS Connector Overview

The Heavy Duty Sealed Connector Series (HDSCS) offers several cavity arrangements and mixed wire sizes. The rugged, thermoplastic connectors have a secondary lock with poke-yoke feature and can be used for in-line or flange mount applications. HDSCS connectors are available in five housing sizes and four keying options.



APPLICABLE PRODUCT DOCUMENTATION

Additional documentation is available for assistance with HDSCS products. The following TE Connectivity document numbers may be helpful:

1654326-1 (Catalog Section)

108-94020 (Product Specification)

114-18756 (Application Specification)

1563709 (Product Group Drawing)

HDSCS CONNECTOR PERFORMANCE SPECIFICATIONS

Current:	Up to 40 amps
Temperature:	Operating at temperatures -40°C to +140°C
Durability:	Up to 10 cycles (tin), up to 50 cycles (silver), up to 100 cycles (gold), see individual product specifications for additional details.
Insulation Resistance:	500 volts DC, test acc. to ISO 16750-2 (4.12).
Immersion:	IP67 rating, IP6K9K with cover, for tab housings with flange, only by observing mounting instructions.
Random Vibration:	No physical damage of housings and contacts, no derogation of function; the connection may not open at 177 m/s ² , 94 hours for each of the three axes. See product specification 108-94020 for full specifications.
Voltage:	Up to 42 volts DC
Dielectric Withstanding Voltage:	No flash over or breakdown between adjacent contacts and outer contour of the housing permitted at 500 volts AC and 50 or 60 Hz for 60 seconds.
Flammability	Product with UL 94 V0 rated material is available

HDSCS Connectors

MATERIAL SPECIFICATIONS

Flange Seal:	Silicone rubber
Seal for Secondary Locking:	Silicone rubber
Housing:	Glass filled PBT
Secondary Locking:	Glass filled PBT
Slide Lock:	Glass filled PBT

DIMENSIONS

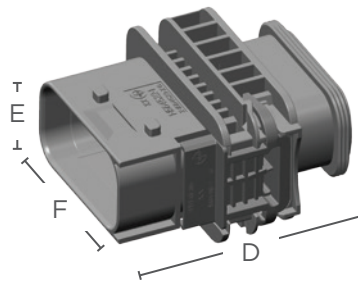
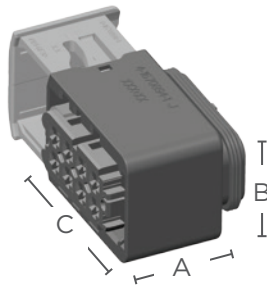

HDSCS Receptacle Housing

HDSCS Tab Housing

Group	Overall Length A	Overall Height B	Overall Width C	Overall Length D	Overall Height E	Overall Width F
A	1.23 (31.3)	0.73 (18.5)	1.02 (26.0)	1.64 (47.1)	0.75 (19.0)	1.09 (27.6)
B	1.23 (31.3)	1.01 (25.7)	1.19 (30.2)	1.64 (47.1)	1.06 (27.0)	1.09 (27.6)
C	1.23 (31.3)	1.01 (25.7)	1.23 (31.2)	1.64 (47.1)	1.06 (27.0)	1.28 (32.6)
D	1.23 (31.3)	1.01 (25.7)	1.54 (39.2)	1.64 (47.1)	1.06 (27.0)	1.60 (40.6)
E	1.23 (31.3)	1.01 (25.7)	2.02 (51.2)	1.64 (47.1)	1.06 (27.0)	2.07 (52.6)

Dimensions are for reference only.

HDSCS Connectors

GROUP A SIZE CONFIGURATIONS



2 Positions
2 size 1.5K



2 Positions
2 size 2.8

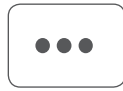

3 Positions
3 size 1.5K

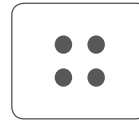

4 Positions
4 size 2.8

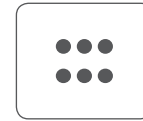

6 Positions
6 size 1.5K

GROUP C SIZE CONFIGURATIONS

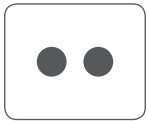

2 Positions
2 size 6.3

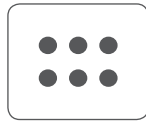

6 Positions
6 size 2.8

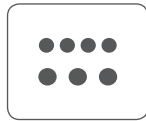

7 Positions
4 size 1.5K
3 size 2.8

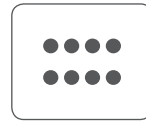

8 Positions
8 size 1.5K

GROUP D SIZE CONFIGURATIONS

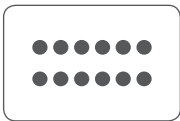

12 Positions
12 size 1.5K

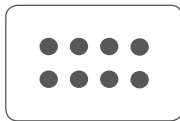

8 Positions
8 size 2.8

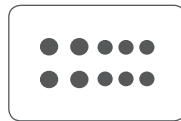

10 Positions
6 size 1.5K
4 size 2.8

GROUP E SIZE CONFIGURATIONS

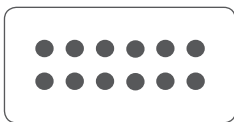

12 Positions
12 size 2.8

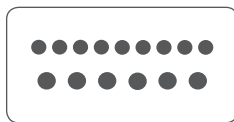

15 Positions
9 size 1.5K
6 size 2.8

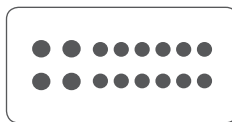

16 Positions
12 size 1.5K
4 size 2.8

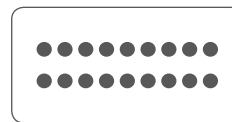

18 Positions
18 size 1.5K

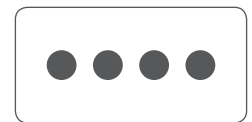

4 Positions
4 size 6.3

HDSCS Connectors

ORDERING INFORMATION

Position	Group	Contact Size	Keying Color	Receptacle Housing	Tab Housing	
					Flange	Without Flange
2	A	2.8	Black	1-1418483-1	1-1703841-1	1-1703839-1
			Gray	2-1418483-1	2-1703841-1	2-1703839-1
			Green	3-1418483-1	3-1703841-1	3-1703839-1
			Blue	4-1418483-1	4-1703841-1	4-1703839-1
(3) 2	A	1.5K	Black	1-1418448-2	-	-
			Gray	2-1418448-2	-	-
			Green	3-1418448-2	-	-
			Blue	4-1418448-2	-	-
2	C	6.3	Black	1-1564542-1	1-1564546-1	1-1564544-1
			Gray	2-1564542-1	2-1564546-1	2-1564544-1
			Green	3-1564542-1	3-1564546-1	3-1564544-1
			Blue	4-1564542-1	4-1564546-1	4-1564544-1
3	A	1.5K	Black	1-1418448-1	1-1703843-1	1-1670730-1
			Gray	2-1418448-1	2-1703843-1	2-1670730-1
			Green	3-1418448-1	3-1703843-1	3-1670730-1
			Blue	4-1418448-1	4-1703843-1	4-1670730-1
4	B	2.8	Black	1-1418390-1	1-1703808-1	1-1703818-1
			Gray	2-1418390-1	2-1703808-1	2-1703818-1
			Green	3-1418390-1	3-1703808-1	3-1703818-1
			Blue	4-1418390-1	4-1703808-1	4-1703818-1
	E	6.3	Black	1-1564330-1	-	1-1564534-1
			Gray	2-1564330-1	-	2-1564534-1
			Green	3-1564330-1	-	3-1564534-1
			Blue	4-1564330-1	-	4-1564534-1
6	B	1.5K	Black	1-1418469-1	1-1703820-1	1-1703773-1
			Gray	2-1418469-1	2-1703820-1	2-1703773-1
			Green	3-1418469-1	3-1703820-1	3-1703773-1
			Blue	4-1418469-1	4-1703820-1	4-1703773-1
	C	2.8	Black	1-1418437-1	-	-
			Gray	2-1418437-1	-	-
			Green	3-1418437-1	-	-
			Blue	4-1418437-1	-	-
7	C	(4) 1.5K (3) 2.8	Black	1-1418480-1	1-1670214-1	1-1703648-1
			Gray	2-1418480-1	2-1670214-1	2-1703648-1
			Green	3-1418480-1	3-1670214-1	3-1703648-1
			Blue	4-1418480-1	4-1670214-1	4-1703648-1

ORDERING INFORMATION (CONTINUED)

Position	Group	Contact Size	Keying Color	Receptacle Housing	Tab Housing	
					Flange	Without Flange
8	C	1.5K	Black	1-1418479-1	1-1564416-1	1-1564512-1
			Gray	2-1418479-1	2-1564416-1	2-1564512-1
			Green	3-1418479-1	3-1564416-1	3-1564512-1
			Blue	4-1418479-1	4-1564416-1	4-1564512-1
	D	2.8	Black	1-1670894-1	-	1-1564522-1
			Gray	2-1670894-1	-	2-1564522-1
			Green	3-1670894-1	-	3-1564522-1
			Blue	4-1670894-1	-	4-1564522-1
10	D	(6) 1.5K (4) 2.8	Black	1-1564514-1	1-1564518-1	1-1564516-1
			Gray	2-1564514-1	2-1564518-1	2-1564516-1
			Green	3-1564514-1	3-1564518-1	3-1564516-1
			Blue	4-1564514-1	4-1564518-1	4-1564516-1
12	D	1.5K	Black	1-1703639-1	1-1564520-1	1-1564414-1
			Gray	2-1703639-1	2-1564520-1	2-1564414-1
			Green	3-1703639-1	3-1564520-1	3-1564414-1
			Blue	4-1703639-1	4-1564520-1	4-1564414-1
	E	2.8	Black	1-1670901-1	-	-
			Gray	2-1670901-1	-	-
			Green	3-1670901-1	-	-
			Blue	4-1670901-1	-	-
15	E	(9) 1.5K (6) 2.8	Black	1-1563878-1	1-1564532-1	1-1564530-1
			Gray	2-1563878-1	2-1564532-1	2-1564530-1
			Green	3-1563878-1	3-1564532-1	3-1564530-1
			Blue	4-1563878-1	4-1564532-1	4-1564530-1
16	E	(12) 1.5K (4) 2.8	Black	1-1564337-1	1-1564407-1	1-1564528-1
			Gray	2-1564337-1	2-1564407-1	2-1564528-1
			Green	3-1564337-1	3-1564407-1	3-1564528-1
			Blue	4-1564337-1	4-1564407-1	4-1564528-1
18	E	1.5K	Black	1-1563759-1	1-1564526-1	1-1564412-1
			Gray	2-1563759-1	2-1564526-1	2-1564412-1
			Green	3-1563759-1	3-1564526-1	3-1564412-1
			Blue	4-1563759-1	4-1564526-1	4-1564412-1

HDSCS Connectors

Accessories

Several accessory items are available to complement the HDSCS connectors including backshells, fixing slides, and protection caps. Accessory items cover a wide array of design requirements such as assisting with mounting, providing additional protection, and offering enhanced aesthetics.

BACKSHELLS

Group	Part Number	Description
A	1670365-1	Vertical adapter for NW 8.5 mm diameter corrugated tubing
	1670150-1	Right-angle adapter for NW 8.5 mm diameter corrugated tubing
B	965576-1	Right-angle adapter with universal clamp
	965784-1	Vertical adapter with universal clamp
	185793-1	Right-angle adapter for NW 7.5 mm diameter corrugated tubing
	965577-1	Right-angle adapter for NW 8.5 mm diameter corrugated tubing
	965783-1	Right-angle adapter for NW 10 mm diameter corrugated tubing
	185792-1	Vertical adapter for NW 7.5 mm diameter corrugated tubing
	965785-1	Vertical adapter for NW 8.5 mm diameter corrugated tubing
	965786-1	Vertical adapter for NW 10 mm diameter corrugated tubing
	1534789-1	Right-angle adapter 4/7 position for hose
	1534791-1	Vertical adapter 4/7 position for hose
	1418916-1	Vertical adapter 4/7 position for jacketed cable 5.2-6.5 mm
	1418917-1	Vertical adapter 4/7 position for jacketed cable 6.0-9.5 mm
	1418918-1	Right-angle adapter 4/7 position for jacketed cable 5.2-6.5 mm
	1418919-1	Right-angle adapter 4/7 position for jacketed cable 6.0-9.5 mm
	C	1670364-1
1670057-1		Right-angle adapter for NW 13 mm diameter corrugated tubing
D	1563111-1	Vertical adapter for NW 13 mm diameter corrugated tubing
	1563110-1	Right-angle adapter for NW 13 mm diameter corrugated tubing
E	1670866-1	Vertical adapter for NW 17 mm diameter corrugated tubing and hose
	1670865-1	Right-angle adapter for NW 17 mm diameter corrugated tubing and hose

HDSCS Connectors

FIXING SLIDES

Fixing slides are used to help secure HDSCS connectors while mounting them. The locking slides can accommodate panel thicknesses from 1.0-3.5 mm.



Group	Part Number	Color	Panel Thickness
A	1703838-6	Gray	3.5 mm
	1703838-1	Yellow	3.0 mm
	1703838-2	Red	2.5 mm
B	1703810-6	Gray	3.5 mm
	1703810-1	Yellow	3.0 mm
	1703810-2	Red	2.5 mm
C	1670720-6	Gray	3.5 mm
	1670720-1	Yellow	3.0 mm
	1670720-2	Red	2.5 mm
D	1564562-1	Yellow	3.0 mm
	1564562-2	Red	2.5 mm
	1564562-5	Gray	1.5 mm
	1564562-4	Natural	1.0 mm
E	1564411-6	Gray	3.5 mm
	1564411-1	Yellow	3.0 mm
	1564411-2	Red	2.5 mm
	1564411-5	Gray	1.5 mm

PROTECTION CAPS

The HDSCS protection caps provide an environmental seal and are used to protect the connector interface when the two halves are not mated.



Group	Part Number	Housing
A	2112299-1	Receptacle
	2112289-1	Tab
B	2112300-1	Receptacle
	2112291-1	Tab
C	2112301-1	Receptacle
	2112293-1	Tab
D	2112302-1	Receptacle
	2112295-1	Tab
E	2112303-1	Receptacle
	2112297-1	Tab

HDSCS Connectors

Contacts

The HDSCS connectors commonly use the AMP MCP stamped & formed contact system.

AMP MCP CONTACT PERFORMANCE SPECIFICATIONS

Durability

10 cycles (tin)
50 cycles (silver)
100 cycles (gold)

Current Rating

Contact Size	Max. Current
1.5K	up to 20 amps
2.8	up to 40 amps
6.3/4.8K	up to 40 amps

Contact Retention

Contact Size	Min. Load
1.5K	40/60 N
2.8	80 N
6.3/4.8K	80 N

Crimp Tensile Strength

Contact Size	Tensile Strength
--------------	------------------

1.5K

.22 mm ²	≥ 32 N
.35 mm ²	≥ 50 N
.50 mm ²	≥ 60 N
.75 mm ²	≥ 85 N
1.0 mm ²	≥ 108 N
1.25 mm ²	≥ 135 N (16 AWG)
1.5 mm ²	≥ 135 N

2.8

.22 mm ²	≥ 28 N
.35 mm ²	≥ 50 N
.50 mm ²	≥ 60 N
.75 mm ²	≥ 85 N
1.0 mm ²	≥ 108 N
1.5 mm ²	≥ 150 N
2.5 mm ²	≥ 200 N

6.3./4.8K

.35 mm ²	≥ 50 N
.50 mm ²	≥ 60 N
.75 mm ²	≥ 85 N
1.0 mm ²	≥ 108 N
1.5 mm ²	≥ 150 N
2.5 mm ²	≥ 200 N
4.0 mm ²	≥ 310 N
6.0 mm ²	≥ 450 N

HDSCS Connectors

AMP MCP CONTACTS FOR HDSCS

Stamped & Formed Tabs with Single Wire Sealing System - AMP MCP

Size	Tab Part Numbers				Wire Size (mm ²)	Insulation Dia. (mm) FLR	Finish
	Strip Form	Package Quantity	Loose Piece	Package Quantity			
1.5K	969028	4000	969029	500	0.2-0.5	1.2-1.6	-2/-3
	964269	4000	964270	500	0.5-1.0	1.4-2.1	-2/-3/-5
	1703278	4000	1703279	500	1.5	1.9-2.4	-2/-5
2.8	965982	3500	965983	500	0.2-0.5	max 2.1	1-xxx-1 1-xxx-3
	962915	3500	963748	500	0.5-1.0	max 2.1	1-xxx-1 1-xxx-2 1-xxx-3 2-xxx-1 2-xxx-2 2-xxx-3
	962916	3300	963749	500	1.5-2.5	max 3.0	1-xxx-1 1-xxx-2 1-xxx-3 2-xxx-1 2-xxx-2 2-xxx-3
	1719504	3200	1719503	500	12 TXL	max 3.2	1-xxx-1 1-xxx-2
6.3/ 4.8K	962917	1500	963742	500	0.5-1.0	1.4-2.1	1-xxx-1 1-xxx-2 2-xxx-1 2-xxx-2
	962918	1500	963743	500	1.5-2.5	2.2-3.0	1-xxx-1 1-xxx-2 2-xxx-1 2-xxx-2
	962919	1500	963744	500	>2.5-4.0	2.7-3.7	1-xxx-1 1-xxx-2 2-xxx-1 2-xxx-2

AMP MCP Tab Finish Codes

Finish Code	Material
-2	CuFe2, pre-tin plated
-3	CuSn4, gold plated
-5	CuSn4, selective silver plated
1-xxx-1	CuSn, pre-tin plated

Finish Code Material

1-xxx-2	CuSn, selective silver plated
1-xxx-3	CuSn, selective gold plated
2-xxx-1	CuFe, pre-tin plated
2-xxx-2	CuFe, selective silver plated
2-xxx-3	CuFe, selective gold plated

HDSCS Connectors

Stamped & Formed Receptacles with Single Wire Sealing System - AMP MCP

Size	Receptacle Part Numbers				Wire Size (mm ²)	Insulation Diameter (mm)		Finish
	Strip Form	Package Quantity	Loose Piece	Package Quantity		FLK	FLR	
1.5K	1564324	4500	1564325	500	0.22-0.35	-	1.1-1.4	-1/-2/-3
	1241380	4500	1241381	500	0.5-1.0	-	1.4-2.1	-1/-2/-3 1-xxx-2*
	1418884	4500	1418885	500	>1.0-1.5	-	2.2-2.4	-1/-3
2.8	968882	4500	968896	500	0.35	-	1.2-1.4	1-xxx-1 1-xxx-3
	968855	3500	968875	500	0.5-1.0	-	1.4-2.1	1-xxx-1 1-xxx-2 1-xxx-3
	968857	4000	968876	500	>1.0-2.5	-	2.2-3.0	1-xxx-1 1-xxx-3
6.3/ 4.8K	1241410	1500	1241411	500	0.35-0.5	1.3-2.3	1.2-1.6	-1/-3
	1241412	1500	1241413	500	0.5-1.0	2.0-2.7	1.4-2.1	-1/-3
	1241414	1500	1241415	500	>1.0-2.5	2.7-3.7	2.2-3.0	-1/-3
	1241416	1500	1241417	500	>2.5-4.0	4.1-4.5	3.4-3.7	-1/-3
	1241418	1500	1241419	500	4.0-6.0	-	3.4-4.3	-4 1-xxx-3 2-xxx-3

AMP MCP Receptacle Finish Codes

Finish Code	Material
-1	CuNiSi, pre-tin plated
-2	CuNiSi, selective gold plated
-3	CuNiSi, selective silver plated
-4	CuNiSi, tin-silver pre-plated
1-xxx-1	CuNiSi, pre-tin plated
1-xxx-2	CuNiSi, selective gold plated
1-xxx-2*	CuNiSi, min 1.27 µm selective gold plated
1-xxx-3	CuNiSi, selective silver plated



HDSCS Connectors

WIRE SEALS

Wire seals are required for connectors without an integrated rear seal to maintain an environmental seal.



Contact Size	Insulation Diameter (mm)	Color	Part Number	Package Quantity
1.5K	0.9-1.2	Green	1718705-1	10,000
	1.2-1.6	Red	964971-1	
		Blue	1394133-1	
	1.4-1.9	Gray	963530-1	
	1.9-2.1	Yellow	964972-1	
	1.9-2.4	Orange	2112323-1	
2.8	1.2-2.1	Blue	828904-1	1000
			828904-2	10,000
	2.2-3.0	White	828905-1	
6.3/4.8K	1.4-2.0	Yellow	2177018-1	10,000
	2.0-2.7	White	1394511-1	
	2.7-2.9	Red brown	1823111-1	
	3.4-3.7	Blue	1394512-1	
	4.0-4.5	Green	1719043-1	

SEALING PLUGS

Open cavities provide pathways for contaminants to enter the connectors. To maintain seal integrity, any unused cavity must be filled with the appropriate size sealing plug.

Contact Size	Wire Size	Color	Part Number	Package Quantity
1.5K	3.6 mm	White	963531-1	10,000
		Natural	1394132-1	
2.8	5.6 mm	Natural	828922-1	
		Green	828922-2	
6.3/4.8K	8.5 mm	Transparent	967652-1	

HDSCS Connectors

Tooling

Tools are specific to the contact style. To create a proper crimp and achieve the highest performance specifications, contacts must be crimped with the recommended tooling.

HAND TOOL FOR AMP MCP CONTACTS



Contact Size	Tab Strip Form	Tab Loose Piece	Receptacle Strip Form	Receptacle Loose Piece	Tool P/N	Description
1.5K	1703278 964269 969028	1703279 964270 969029	-	-	539663-2 (die) 539663-2 (frame)	ERGOCRIMP hand tool and die assembly
	-	-	1418884	1418885	5-1579001-3 (die) 539635-1 (frame)	
	-	-	1564324	1564325	4-1579016-0 (die) 539635-1 (frame)	
2.8	962915 962916	963748 963749	-	-	539758-2 (die) 539635-1 (frame)	ERGOCRIMP hand tool and die assembly
	965982	965983	-	-	539737-2 (die) 539635-1 (frame)	
	-	-	968882	968896	539725-2 (die) 539635-1 (frame)	
6.3/ 4.8K	962917 962918 962919	963742 963743 963744	-	-	539757-2 (die) 539635-1 (frame)	ERGOCRIMP hand tool and die assembly
	-	-	1241410 1241412	1241411 1241413	539955-2 (die) 539635-1 (frame)	
	-	-	1241416 1241414	1241415 1241417	539956-2 (die) 539635-1 (frame)	
	-	-	1241418	1241419	3-1579021-7 (die) 539635-1 (frame)	

HDSCS Connectors

AUTOMATED FOR AMP MCP CONTACTS



OCEAN end
feed applicator

Contact Size	Tab Strip Form	Receptacle Strip Form	Applicator P/N	Feed Type
1.5K	969028	-	2151056-1	Mechanical end feed
			2151056-2	Pneumatic end feed
	964269	-	2151935-1	Mechanical end feed
			2151935-2	Pneumatic end feed
	1703278	-	2266180-1	Mechanical end feed
			2266180-2	Pneumatic end feed
	-	1418884	2266179-1	Mechanical end feed
			2266179-2	Pneumatic end feed
	-	1564324	2151469-1	Mechanical end feed
			2151469-2	Pneumatic end feed
2.8	962915	-	2151181-1	Mechanical end feed
			2151181-2	Pneumatic end feed
	962916	-	2151260-1	Mechanical end feed
			2151260-2	Pneumatic end feed
	965982	-	2151840-1	Mechanical end feed
			2151840-2	Pneumatic end feed
	-	968882	2151559-1	Mechanical end feed
			2151559-2	Pneumatic end feed

Note: Applicators with additional feed styles are available, contact your representative

HDSCS Connectors

AUTOMATED FOR AMP MCP CONTACTS (CONTINUED)

Contact Size	Tab Strip Form	Receptacle Strip Form	Applicator P/N	Description
6.3/4.8K	962917	-	2266535-1	Mechanical end feed
			2266535-2	Pneumatic end feed
	962918	-	2151783-1	Mechanical end feed
			2151783-2	Pneumatic end feed
	962919	-	2151782-1	Mechanical end feed
			2151782-2	Pneumatic end feed
	-	1241410	2151695-1	Mechanical end feed
			2151695-2	Pneumatic end feed
	-	1241412	2151234-1	Mechanical end feed
			2151234-2	Pneumatic end feed
	-	1241416	2151151-1	Mechanical end feed
			2151151-2	Pneumatic end feed
	-	1241414	2266490-1	Mechanical end feed
			2266490-2	Pneumatic end feed
	-	1241418	2151466-1	Mechanical end feed
			2151466-2	Pneumatic end feed

Note: Applicators with additional feed styles are available, contact your representative

EXTRACTION AND INSERTION TOOLS FOR AMP MCP CONTACTS

Contact Size	Part Number	Description
1.5K	539960-1	Extraction
	1-1579007-1	Extraction
	1579008-9	Insertion
2.8	519609-1	Insertion
2.8 6.3/4.8K	1-1579007-6	Extraction
6.3/4.8K	1-1579007-3	Extraction

How To Instructions

CONTACT INSERTION

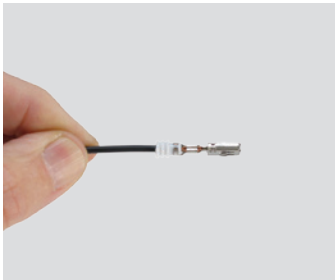

Step 1:
Grasp crimped contact approximately one inch behind the contact barrel.



Step 2:
Make sure the contact is in the correct orientation. Verify the integrated secondary lock is in the unlocked position.



Step 3:
Push contact straight into connector grommet until a click is felt. A slight tug will confirm that it is properly locked in place.

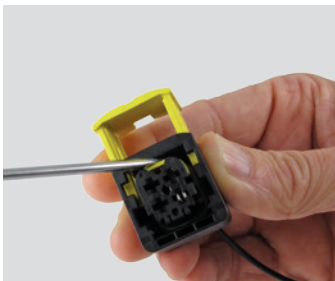

Step 4:
Push the integrated secondary lock into the locked position with a DT-RT1 or a screwdriver.

HDSCS Connectors

CONTACT REMOVAL

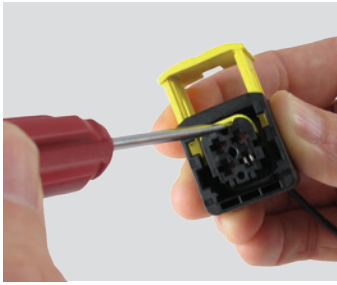

Step 1:
Using a DT-RT1 or a screwdriver, unlock the integrated secondary lock.

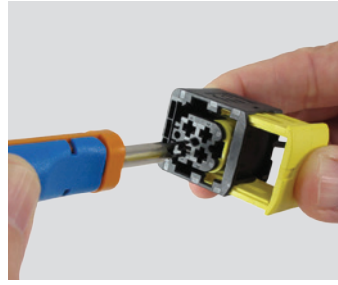

Step 2:
Using the appropriate extraction tool, insert the blades into the contact cavity until they stop.

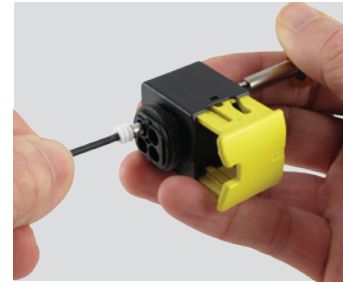

Step 3:
Pull contact wire assembly out of connector.

NOTES:

Contents

LEAVYSEAL Connector Overview.....	64
Product Documentation.....	64
Performance Specifications.....	64
Material Specifications.....	64
Dimensions.....	65
Configurations.....	65-66
Ordering Information.....	67-68
Accessories.....	69-71
Contacts.....	71-73
Tooling.....	75-77
How To Instructions.....	78

LEAVYSEAL Connectors

LEAVYSEAL Connector Overview

The rugged LEAVYSEAL connectors are multi-pin and accept multiple wire sizes. LEAVYSEAL products utilize a lever lock system for mating and are available in several mounting styles and keying options. The housings come in six sizes and feature an integrated cable attachment.



APPLICABLE PRODUCT DOCUMENTATION

Additional documentation is available for assistance with LEAVYSEAL products. The following TE Connectivity document numbers may be helpful:

1307998-3 (Catalog Section)

108-18696 (Product Specification)

114-18376 (Application Specification)

2293396 (Product Group Drawing)

LEAVYSEAL CONNECTOR PERFORMANCE SPECIFICATIONS

Current:	Up to 40 amps
Temperature:	Operating at temperatures ranges -40°C to +140°C, see individual product specifications for specific range.
Durability:	Up to 20 cycles (tin), up to 50 cycles (silver), up to 100 cycles (gold), see individual product specifications for additional details.
Insulation Resistance:	500 volts DC, see individual product specifications for testing conditions.
Immersion:	IP67 rating, IP6K9K with cover
Voltage:	42 volts AC/DC
Dielectric Withstanding Voltage:	No flash over or breakdown between adjacent contacts and outer contour of the housing permitted at 500 volts AC and 50 or 60 Hz for 60 seconds.
Flammability	Product with a UL 94 V0 rated material is available

MATERIAL SPECIFICATIONS

Flange Seal:	Silicone rubber
Housing:	Glass filled PBT
Secondary Locking:	Glass filled PBT

LEAVYSEAL Connectors

DIMENSIONS

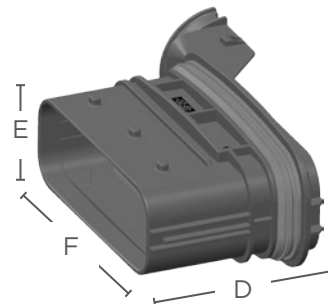
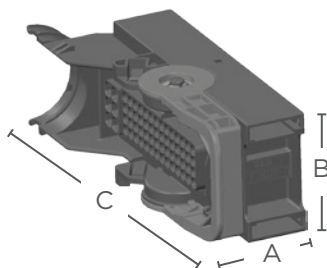

LEAVYSEAL Receptacle Housing

LEAVYSEAL Tab Housing

Group	Overall Length A	Overall Height B	Overall Width C	Overall Length D	Overall Height E	Overall Width F
1	1.46 (37.0)	1.57 (40.0)	2.33 (57.9)	1.48 (37.6)	1.93 (49.0)	1.91 (48.4)
2	1.49 (37.9)	1.72 (43.7)	2.73 (69.4)	1.81 (46.1)	2.03 (51.5)	2.62 (66.6)
3	1.73 (44.0)	1.64 (41.7)	3.64 (92.5)	2.19 (55.5)	2.47 (62.7)	3.62 (92.0)
4	1.43 (36.4)	1.71 (43.5)	4.09 (104.0)	-	-	-
5	1.73 (44.0)	1.81 (46.0)	4.04 (102.5)	1.80 (45.8)	2.78 (70.7)	4.46 (113.3)
6	1.83 (46.6)	1.79 (45.5)	5.26 (133.5)	-	-	-

Dimensions are for reference only.

GROUP 1 CONFIGURATIONS

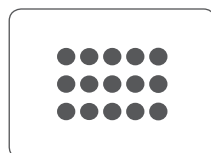

15 Positions
15 size 2.8

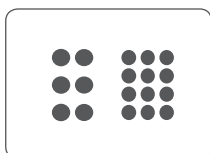

18 Positions
12 size 1.5K
6 size 2.8

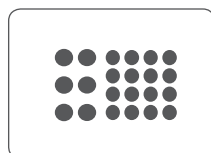

22 Positions
16 size 1.5K
6 size 2.8

GROUP 2 CONFIGURATIONS

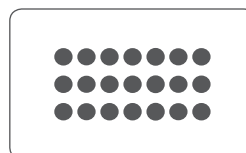

21 Positions
21 size 2.8

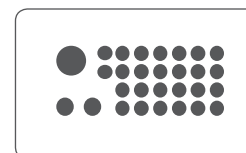

29 Positions
26 size 1.5K
2 size 2.8
1 size 6.3

GROUP 3 CONFIGURATIONS

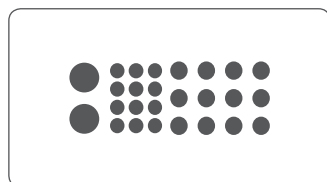

26 Positions
12 size 1.5K
12 size 2.8
2 size 6.3

GROUP 4 CONFIGURATIONS

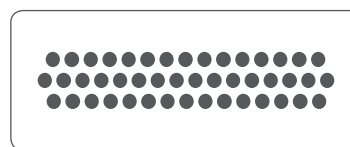

46 Positions
46 size 1.5K

LEAVYSEAL Connectors

GROUP 5 CONFIGURATIONS

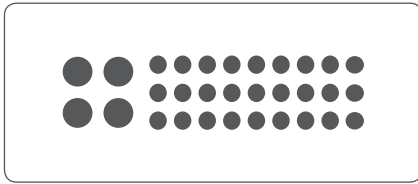

31 Positions
27 size 2.8
4 size 6.3

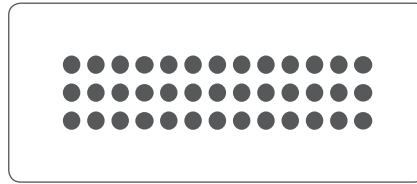

39 Positions
39 size 2.8

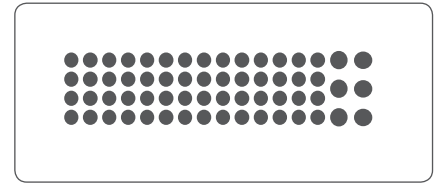

62 Positions
56 size 1.5K
6 size 2.8

GROUP 6 CONFIGURATIONS

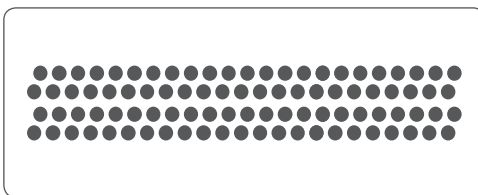

92 Positions
92 size 1.5K

LEAVYSEAL Connectors

ORDERING INFORMATION

Position	Group	Contact Size	Keying	Housing Color	Receptacle Housing	Tab Housing	
						In-line/Flange	PCB
15	1	2.8	A	Black	1-1534126-1	1703799-1	-
			B	Natural	2-1534126-1	-	-
			C	Blue	3-1534126-1	-	-
21	2	2.8	A	Black	1-1534127-1	1-2112162-1 (flange)	1534238-1 (straight)
			B	Natural	2-1534127-1	2-2112162-1	-
			C	Blue	3-1534127-1	3-2112162-1	-
			D	Violet	4-1534127-1	4-2112162-1	-
31	5	(27) 2.8 (4) 6.3	A	Bordeaux	1-1564297-6	-	-
39	5	2.8	E	Emerald Green	5-1718321-3	5-1718323-1	5-1418363-1 (straight)
			F	Fawn Brown	6-1718321-3	6-1718323-1	5-1418363-3 (90°)
46	4	1.5K	A	Black	1-2112231-1	-	-
62	5	(56) 1.5K (6) 2.8	A	Black	1-1418883-1	1-1718324-1	1-1418362-1 (straight)
			B	Gray	2-1418883-1	2-1718324-1	1-1418362-3 (90°)
			C	Blue	3-1418883-1	3-1718324-1	2-1418362-1 (straight)
			D	Green	4-1418883-1	-	2-1418362-3 (90°)
92	6	1.5K	A	Black	1-703998-1 (NW 26 wire exit)	-	1-1452228-9 (straight)
					3-1703998-1 (NW 29 wire exit)		
			B	Black	4-1703998-1 (NW 29 wire exit)	-	-
C	Black	5-1703998-1 (NW 29 wire exit)	-	-			

LEAVYSEAL Connectors

ORDERING INFORMATION - VO RATED MATERIAL

Position	Group	Contact Size	Keying	Housing Color	Receptacle Housing	Tab Housing	
						In-line/Flange	PCB
18	1	(12) 1.5K (6) 2.8	A	Black	1823440-2	1-1823448-2	-
21	2	2.8	A	Black	1-2208688-1	1-2112162-1* (flange)	1534238-1* (straight)
22	1	(16) 1.5K (6) 2.8	A	Black	1-1823440-3	1-1823449-1	-
			B	Gray	2-1823440-3	2-1823449-1	-
			C	Blue	3-1823440-3	-	-
			D	Green	4-1823440-3	-	-
26	3	(12) 1.5K (12) 2.8 (2) 6.3	A	Black	1-2112035-1	1-2112041-1	-
						1-2112041-2	
29	2	(26) 1.5K (2) 2.8 (1) 6.3	A	Black	1-1823402-1	-	-
			B	Gray	2-1823402-1	-	-
			C	Blue	3-1823402-1	-	-
31	5	(27) 2.8 (4) 6.3	A	Bordeaux	1-2208685-6	-	-
39	5	2.8	E	Emerald Green	5-2208684-3	5-1718323-1*	5-1418363-1* (straight)
			F	Fawn Brown	6-2208684-3	6-1718323-1*	5-1418362-3* (90°)
62	5	(56) 1.5K (6) 2.8	A	Black	1-1823498-1	-	-
			B	Gray	2-1823498-1	-	-
			C	Blue	3-1823498-1	-	-
			D	Green	4-1823498-1	-	-

*Non-VO rated material

LEAVYSEAL Connectors

Accessories

Backshells, adapters, locking slides, and protective covers are accessory items available for use with LEAVYSEAL connectors. These accessories cover design requirements by assisting with mounting, providing additional protection, and offering increased aesthetics.

BACKSHELLS/COVERS

To achieve an IP6K9K rating, backshells must be used with the LEAVYSEAL connectors. The 90° backshells are available with ribs to accommodate corrugated tubing.



Positions	Housing	Part Number	Tubing
15	Receptacle	9-1394049-1	NW 13
	Tab	9-1394049	NW 13
21	Receptacle	9-1394050-1	NW 17
	Tab	2112167-1	NW 17
22	Receptacle	2112452-1	NW 17
26	Receptacle or Tab	2112046-1	NW 22
31	Receptacle	1418882-1	NW 26
39	Receptacle	1418882-1	NW 26
	Tab		
46	Receptacle	2112233-1	NW 22
62	Receptacle	1418882-1	NW 26
	Tab		
62 (V0)	Receptacle/Tab	1823500-1	NW 26
92	Receptacle (NW 26 wire exit)	1703997-1	NW 26
	Receptacle (NW 29 wire exit)	2141345-1	NW 29

LEAVYSEAL Connectors

ADAPTERS

Adapters are available to aid in mounting LEAVYSEAL connectors. The adapters are available in multiple sizes and can mount up to four LEAVYSEAL connectors.



Positions	Housing	Part Number	Description
15/22	Tab	1703806-1	1 bay, sealed
39/62	Tab	1718329-1	1 bay, unsealed
		1813123-1	2 bays, unsealed
		1813123-2	2 bays, 1 bay closed, unsealed
		2138002-1	4 bays, sealed

LOCKING SLIDES

Locking slides are used to help secure LEAVYSEAL connectors while mounting them. The locking slides may be used with adapters or panels with a thickness of 2.5 mm, 3.0 mm, or 3.5 mm.



Positions	Part Number	Color	Description
15/22	1703804-1	Red	For use with adapter
21	2112166-1	Red	For use with 2.5 mm panel thickness
	2112166-2	Yellow	For use with 3 mm panel thickness
	2112166-3	Gray	For use with 3.5 mm panel thickness
26	2112045-1	Red	For use with 2.5 mm panel thickness
	2112045-2	Yellow	For use with 3 mm panel thickness
39/62	1718328-1	Red	For use with adapter

LEAVYSEAL Connectors

INTERFACE PROTECTION COVER

The LEAVYSEAL protection cover provides an environmental seal and is used to protect the connector interface when the two halves are not mated.

Positions	Part Number	Color
21	1-1394052-1	Black

Contacts

The LEAVYSEAL connectors commonly use the AMP MCP stamped & formed contact system.

AMP MCP CONTACT PERFORMANCE SPECIFICATIONS

Durability

10 cycles (tin)
50 cycles (silver)
100 cycles (gold)

Current Rating

Contact Size	Max. Current
1.5K	up to 20 amps
2.8	up to 40 amps
6.3/4.8K	up to 40 amps

Contact Retention

Contact Size	Min. Load
1.5K	40/60 N
2.8	80 N
6.3/4.8K	80 N

Crimp Tensile Strength

Contact Size	Tensile Strength
1.5K	
.22 mm ²	≥ 32 N
.35 mm ²	≥ 50 N
.50 mm ²	≥ 60 N
.75 mm ²	≥ 85 N
1.0 mm ²	≥ 108 N
1.25 mm ²	≥ 135 N (16 AWG)
1.5 mm ²	≥ 135 N
2.8	
.22 mm ²	≥ 28 N
.35 mm ²	≥ 50 N
.50 mm ²	≥ 60 N
.75 mm ²	≥ 85 N
1.0 mm ²	≥ 108 N
1.5 mm ²	≥ 150 N
2.5 mm ²	≥ 200 N
6.3/4.8K	
.35 mm ²	≥ 50 N
.50 mm ²	≥ 60 N
.75 mm ²	≥ 85 N
1.0 mm ²	≥ 108 N
1.5 mm ²	≥ 150 N
2.5 mm ²	≥ 200 N
4.0 mm ²	≥ 310 N
6.0 mm ²	≥ 450 N

LEAVYSEAL Connectors

AMP MCP CONTACTS FOR LEAVYSEAL

Stamped & Formed Tabs with Single Wire Sealing System - AMP MCP

Size	Tab Part Numbers				Wire Size (mm ²)	Insulation Dia. (mm) FLR	Finish
	Strip Form	Package Quantity	Loose Piece	Package Quantity			
1.5K	969028	4000	969029	500	0.2-0.5	1.2-1.6	-2/-3
	964269	4000	964270	500	0.5-1.0	1.4-2.1	-2/-3/-5
	1703278	4000	1703279	500	1.5	1.9-2.4	-2/-5
2.8	965982	3500	965983	500	0.2-0.5	max 2.1	1-xxx-1 1-xxx-3
	962915	3500	963748	500	0.5-1.0	max 2.1	1-xxx-1 1-xxx-2 1-xxx-3 2-xxx-1 2-xxx-2 2-xxx-3
	962916	3300	963749	500	1.5-2.5	max 3.0	1-xxx-1 1-xxx-2 1-xxx-3 2-xxx-1 2-xxx-2 2-xxx-3
	1719504	3200	1719503	500	12 TXL	max 3.2	1-xxx-1 1-xxx-2
6.3/ 4.8K	962917	1500	963742	500	0.5-1.0	1.4-2.1	1-xxx-1 1-xxx-2 2-xxx-1 2-xxx-2
	962918	1500	963743	500	1.5-2.5	2.2-3.0	1-xxx-1 1-xxx-2 2-xxx-1 2-xxx-2
	962919	1500	963744	500	>2.5-4.0	2.7-3.7	1-xxx-1 1-xxx-2 2-xxx-1 2-xxx-2

AMP MCP Tab Finish Codes

Finish Code	Material
-2	CuFe2, pre-tin plated
-3	CuSn4, gold plated
-5	CuSn4, selective silver plated
1-xxx-1	CuSn, pre-tin plated

Finish Code Material

1-xxx-2	CuSn, selective silver plated
1-xxx-3	CuSn, selective gold plated
2-xxx-1	CuFe, pre-tin plated
2-xxx-2	CuFe, selective silver plated
2-xxx-3	CuFe, selective gold plated

LEAVYSEAL Connectors

Stamped & Formed Receptacles with Single Wire Sealing System - AMP MCP

Size	Receptacle Part Numbers				Wire Size (mm ²)	Insulation Diameter (mm)		Finish
	Strip Form	Package Quantity	Loose Piece	Package Quantity		FLK	FLR	
1.5K	1564324	4500	1564325	500	0.22-0.35	-	1.1-1.4	-1/-2/-3
	1241380	4500	1241381	500	0.5-1.0	-	1.4-2.1	-1/-2/-3 1-xxx-2*
	1418884	4500	1418885	500	>1.0-1.5	-	2.2-2.4	-1/-3
2.8	968882	4500	968896	500	0.35	-	1.2-1.4	1-xxx-1 1-xxx-3
	968855	3500	968875	500	0.5-1.0	-	1.4-2.1	1-xxx-1 1-xxx-2 1-xxx-3
	968857	4000	968876	500	>1.0-2.5	-	2.2-3.0	1-xxx-1 1-xxx-3
6.3/ 4.8K	1241410	1500	1241411	500	0.35-0.5	1.3-2.3	1.2-1.6	-1/-3
	1241412	1500	1241413	500	0.5-1.0	2.0-2.7	1.4-2.1	-1/-3
	1241414	1500	1241415	500	>1.0-2.5	2.7-3.7	2.2-3.0	-1/-3
	1241416	1500	1241417	500	>2.5-4.0	4.1-4.5	3.4-3.7	-1/-3
	1241418	1500	1241419	500	4.0-6.0	-	3.4-4.3	-4 1-xxx-3 2-xxx-3

AMP MCP Receptacle Finish Codes

Finish Code	Material
-1	CuNiSi, pre-tin plated
-2	CuNiSi, selective gold plated
-3	CuNiSi, selective silver plated
-4	CuNiSi, tin-silver pre-plated
1-xxx-1	CuNiSi, pre-tin plated
1-xxx-2	CuNiSi, selective gold plated
1-xxx-2*	CuNiSi, min 1.27 µm selective gold plated
1-xxx-3	CuNiSi, selective silver plated



LEAVYSEAL Connectors

WIRE SEALS

Wire seals are required for connectors without an integrated rear seal to maintain an environmental seal.



Contact Size	Insulation Diameter (mm)	Color	Part Number	Package Quantity
1.5K	0.9-1.2	Green	1718705-1	10,000
	1.2-1.6	Red	964971-1	
		Blue	1394133-1	
	1.4-1.9	Gray	963530-1	
	1.9-2.1	Yellow	964972-1	
	1.9-2.4	Orange	2112323-1	
2.8	1.2-2.1	Blue	828904-1	1000
			828904-2	10,000
	2.2-3.0	White	828905-1	
6.3/4.8K	1.4-2.0	Yellow	2177018-1	10,000
	2.0-2.7	White	1394511-1	
	2.7-2.9	Red brown	1823111-1	
	3.4-3.7	Blue	1394512-1	
	4.0-4.5	Green	1719043-1	

SEALING PLUGS

Open cavities provide pathways for contaminants to enter the connectors. To maintain seal integrity, any unused cavity must be filled with the appropriate size sealing plug.

Contact Size	Wire Size	Color	Part Number	Package Quantity
1.5K	3.6 mm	White	963531-1	10,000
		Natural	1394132-1	
2.8	5.6 mm	Natural	828922-1	
		Green	828922-2	
6.3/4.8K	8.5 mm	Transparent	967652-1	

LEAVYSEAL Connectors

Tooling

Tools are specific to the contact style. To create a proper crimp and achieve the highest performance specifications, contacts must be crimped with the recommended tooling.

HAND TOOL FOR AMP MCP CONTACTS



Contact Size	Tab Strip Form	Tab Loose Piece	Receptacle Strip Form	Receptacle Loose Piece	Tool P/N	Description
1.5K	1703278 964269 969028	1703279 964270 969029	-	-	539663-2 (die) 539663-2 (frame)	ERGOCRIMP hand tool and die assembly
	-	-	1418884	1418885	5-1579001-3 (die) 539635-1 (frame)	
	-	-	1564324	1564325	4-1579016-0 (die) 539635-1 (frame)	
2.8	962915 962916	963748 963749	-	-	539758-2 (die) 539635-1 (frame)	ERGOCRIMP hand tool and die assembly
	965982	965983	-	-	539737-2 (die) 539635-1 (frame)	
	-	-	968882	968896	539725-2 (die) 539635-1 (frame)	
6.3/ 4.8K	962917 962918 962919	963742 963743 963744	-	-	539757-2 (die) 539635-1 (frame)	ERGOCRIMP hand tool and die assembly
	-	-	1241410 1241412	1241411 1241413	539955-2 (die) 539635-1 (frame)	
	-	-	1241416 1241414	1241415 1241417	539956-2 (die) 539635-1 (frame)	
	-	-	1241418	1241419	3-1579021-7 (die) 539635-1 (frame)	

AUTOMATED FOR AMP MCP CONTACTS



OCEAN end feed applicator

Contact Size	Tab Strip Form	Receptacle Strip Form	Applicator P/N	Feed Type	
1.5K	969028	-	2151056-1	Mechanical end feed	
			2151056-2	Pneumatic end feed	
	964269	-	2151935-1	Mechanical end feed	
			2151935-2	Pneumatic end feed	
	1703278	-	2266180-1	Mechanical end feed	
			2266180-2	Pneumatic end feed	
	-	1418884	2266179-1	Mechanical end feed	
			2266179-2	Pneumatic end feed	
	-	1564324	2151469-1	Mechanical end feed	
			2151469-2	Pneumatic end feed	
	2.8	962915	-	2151181-1	Mechanical end feed
				2151181-2	Pneumatic end feed
962916		-	2151260-1	Mechanical end feed	
			2151260-2	Pneumatic end feed	
965982		-	2151840-1	Mechanical end feed	
			2151840-2	Pneumatic end feed	
-		968882	2151559-1	Mechanical end feed	
			2151559-2	Pneumatic end feed	

Note: Applicators with additional feed styles are available, contact your representative

LEAVYSEAL Connectors

AUTOMATED FOR AMP MCP CONTACTS (CONTINUED)

Contact Size	Tab Strip Form	Receptacle Strip Form	Applicator P/N	Description
6.3/4.8K	962917	-	2266535-1	Mechanical end feed
			2266535-2	Pneumatic end feed
	962918	-	2151783-1	Mechanical end feed
			2151783-2	Pneumatic end feed
	962919	-	2151782-1	Mechanical end feed
			2151782-2	Pneumatic end feed
	-	1241410	2151695-1	Mechanical end feed
			2151695-2	Pneumatic end feed
	-	1241412	2151234-1	Mechanical end feed
			2151234-2	Pneumatic end feed
	-	1241416	2151151-1	Mechanical end feed
			2151151-2	Pneumatic end feed
	-	1241414	2266490-1	Mechanical end feed
			2266490-2	Pneumatic end feed
	-	1241418	2151466-1	Mechanical end feed
			2151466-2	Pneumatic end feed

Note: Applicators with additional feed styles are available, contact your representative

How To Instructions

CONTACT INSERTION

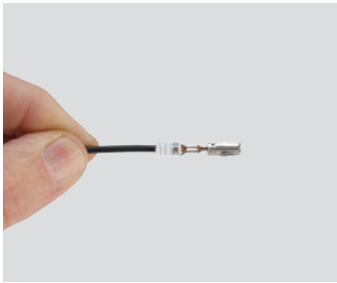

Step 1:
Grasp crimped contact approximately one inch behind the contact barrel.

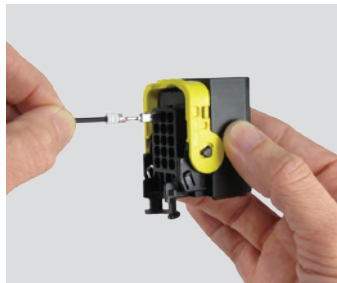

Step 2:
Verify the integrated secondary lock is in the unlocked position. Make sure the contact is in the correct orientation. Push contact straight into connector grommet until a click is felt. A slight tug will confirm that it is properly locked in place.

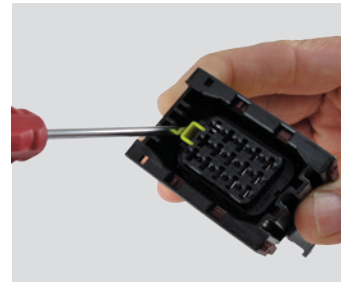

Step 3:
Push the integrated secondary lock into the locked position with a DT-RT1 or a screwdriver.

CONTACT REMOVAL



Step 1:
Using a DT-RT1 or a screwdriver, unlock the integrated secondary lock.



Step 2:
Using the appropriate extraction tool, insert the blades into the contact cavity until they stop.



Step 3:
Pull contact wire assembly out of connector.

Contents

Superseal 1.0 Connector Overview	80
Product Documentation.....	80
Performance Specifications	80
Material Specifications.....	80
Dimensions	81
Configurations.....	81
Ordering Information.....	82
Contacts	83
Tooling.....	84

Superseal 1.0 Connectors

Superseal 1.0 Connector Overview

The Superseal 1.0 mm connectors are designed to meet the increasing need for dependable printed circuit board applications in harsh environments. The Superseal headers are available with straight or right-angle pins. Various locking latch options and keying configurations are available.



APPLICABLE PRODUCT DOCUMENTATION

Additional documentation is available for assistance with Superseal 1.0 products. The following TE document numbers may be helpful:

1308072-2 (Catalog Section)
108-78140 (Product Specification)
114-78011 (Application Specification)

SUPERSEAL 1.0 CONNECTOR PERFORMANCE SPECIFICATIONS

Current:	Up to 15 amps
Temperature:	Operating at temperatures -40°C to +125°C
Durability:	After cap housing is connected, the plug housing is mated and then 78.4 N force is applied in a rocking motion. 25 test cycles.
Insulation Resistance:	100 megohms minimum. Test between adjacent contacts and between contact and earth with insulation resistance meter of 500 volts DC.
Immersion:	Per JIS D0203
Random Vibration:	Tested in each of three mutually perpendicular axis. See Fig 8 in product document 108-78140.
Dielectric Withstanding Voltage:	Insulation does not breakdown at 1000 volts AC or 1600 volts DC for duration of 1 minute between contacts and between contact and earth.
Voltage:	250 volts AC, DC

MATERIAL SPECIFICATIONS

Grommet:	Silicone rubber
Housing:	Thermoplastic
TPA:	Thermoplastic polyester

Superseal 1.0 Connectors

DIMENSIONS



Superseal 1.0 Plug Housing

Superseal 1.0 Pin Header

Cavity	Overall Length A	Overall Height B	Overall Width C	Overall Length Vertical D	Overall Height E	Overall Width F	Overall Length 90° G
26	1.26 (32.1)	1.36 (34.5)	1.26 (32.1)	1.14 (29.0)	1.23 (31.4)	1.55 (39.5)	1.44 (36.5)
34	1.26 (32.1)	1.49 (38.0)	1.50 (38.2)	1.14 (29.0)	1.23 (31.4)	1.79 (45.5)	1.44 (36.5)
60	-	-	-	-	1.23 (31.4)	3.07 (78.0)	1.44 (36.5)

Dimensions are for reference only.

CONFIGURATIONS

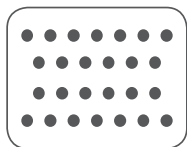

26 Positions
26 size 1.0 mm

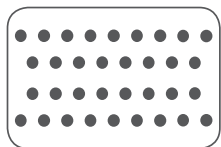

34 Positions
34 size 1.0 mm

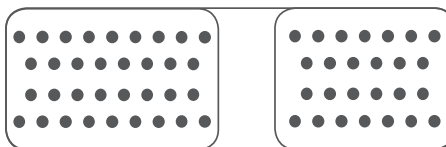

60 Positions
60 size 1.0 mm

ORDERING INFORMATION

Position	Pin Header	Plug Housing	Keying Type	Locking
26	9-6437287-8	3-1437290-7	1 (4 row)	Upper
	9-6437287-9	3-1437290-8	2 (4 row)	Upper
	6473423-1	1473416-1	3 (4 row)	Upper
	6473423-2	1473416-2	4 (4 row)	Upper
	5-6447223-0	3-1437290-7	1 (4 row)	Lower
	6437288-4	3-1437290-8	2 (4 row)	Lower
	2-6437285-8	2-1437285-2	1 (4 row)	Double
	2-6437285-9	1-1447232-7	2 (4 row)	Double
	6437288-6	3-1437290-7	1 (4 row, vertical)	Upper
	6473418-1	3-1437290-8	2 (4 row, vertical)	Upper
	6473418-2	1473416-1	3 (4 row, vertical)	Upper
	6473711-1	1473712-1	1 (2 row)	Upper
	6473711-2		1 (2 row)	Lower
	34	6437288-1	4-1437290-0	1 (4 row)
6437288-2		4-1437290-1	2 (4 row)	Upper
2-6437285-5		4-1437290-0	1 (4 row)	Lower
2-6437285-6		4-1437290-1	2 (4 row)	Lower
3-6437285-0		2-1437285-3	1 (4 row)	Double
3-6437285-1		3-1437290-9	2 (4 row)	Double
2-6447232-3		4-1437290-0	1 (4 row, vertical)	Upper
2-6447232-4		4-1437290-1	2 (4 row, vertical)	Upper
60	6437288-3	3-1437290-7 (26P), 4-1437290-0 (34P)	1 (4 row)	Upper
	6473427-1	1473416-1 (26P), 4-1437290-1 (34P)	2 + 3 (4 row)	Upper
	6437288-5	3-1437290-7 (26P), 4-143790-0 (34P)	1 (4 row)	Lower
	3-6437285-2	2-1437285-2 (26P), 2-1437285-3 (34P)	1 (4 row)	Double

Superseal 1.0 Connectors

Contacts

The Superseal 1.0 mm connectors commonly use the AMP Superseal double spring, stamped & formed contact system.

1.0 MM CONTACT PERFORMANCE SPECIFICATIONS

Durability

25 cycles, per “Kojiri” (rocking motion) durability test

Contact Retention (between contact and housing)

1.0mm \geq 58.8N

Current Rating

Up to 15 amps, consult TE product specification 108-78140

Crimp Tensile Strength

Contact Size	Tensile Strength
.5mm ²	\geq 88.2N
.85 mm ²	\geq 127.4N
1.25 mm ²	\geq 176.4N

1.0 MM STAMPED & FORMED CONTACTS FOR SUPERSEAL 1.0



Stamped & Formed Receptacles - 1.0 mm

Size	Receptacle Strip Form	Wire Size (mm ²)	Insulation Diameter (mm)	Finish
1.0 mm	3-1447221-4	0.5	1.6-2.2	Copper alloy Gold over nickel (contact part), Tin over Nickel (crimp area)
	3-1447221-3	.75-.85	1.6-2.4	
		1.25	1.9-2.2	

SEALING PLUGS

Open cavities provide pathways for contaminants to enter the connectors. To maintain seal integrity, any unused cavity must be filled with the appropriate size sealing plug.



Contact Size	Color	Part Number
1.0 mm	White	4-1437284-3

Superseal 1.0 Connectors

Tooling

Tools are specific to the contact style. To create a proper crimp and achieve the highest performance specifications, contacts must be crimped with the recommended tooling.

HAND TOOLS FOR 1.0 MM CONTACTS



Receptacle P/N	Tool P/N	Description
3-1447221-3 3-1447221-4	1454509-1	CERTI-CRIMP straight action hand tool with fixed dies

AUTOMATED TOOLING FOR 1.0 MM CONTACTS



Receptacle P/N	Applicator P/N	Description
3-1447221-3 3-1447221-4	2151705-1	OCEAN end feed applicator with mechanical feed
	2151705-2	OCEAN end feed applicator with pneumatic feed

Note: Applicators with additional feed styles are available, contact your representative

Contents

AEC Series Overview	86
Performance Specifications	86
Material Specifications	86
Dimensions	87
Configurations	87
Ordering Information	88
Accessories	89
How To Instructions	89-90

AEC Series Overview

DEUTSCH AEC series connectors are environmentally sealed, heavy duty electrical connectors that accept size 16 contacts. The AEC series connectors are constructed of rugged thermoplastic and offer several keying options.



DEUTSCH CONNECTOR PERFORMANCE SPECIFICATIONS

Temperature:	Operating at temperatures -55°C to +125°C
Durability:	No electrical or mechanical defects after 100 cycles of engagement and disengagement.
Vibration:	No unlocking or unmating and exhibits no mechanical or physical damage after sinusoidal vibration levels of 20 G's at 10 to 2000 Hz in each of the three mutually perpendicular planes. No electrical discontinuities longer than 1 microsecond.
Fluid Resistance:	Connectors show no damage when exposed to most fluids used in industrial applications.
Insulation Resistance:	1000 megohms minimum at 25°C.
Immersion:	IP68 rating
Moisture Resistance:	Properly wired and mated connections will withstand immersion under three feet of water without loss of electronic qualities or leakage.
Dielectric Withstanding Voltage:	Current leakage less than 2 milliamps at 1500 volts AC.
Thermal Cycle:	No cracking, chipping or leaking after 20 test cycles from -55°C to +125°C.

MATERIAL SPECIFICATIONS

Grommet:	Silicone rubber
Jackscrew:	Stainless steel
Plug Threaded Inserts:	Stainless steel
Receptacle Threaded Inserts:	Stainless steel/brass
Shell:	Glass filled PEI

AEC Series

DIMENSIONS

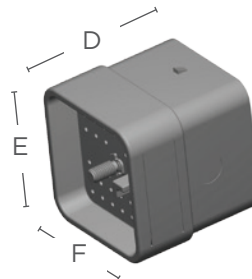
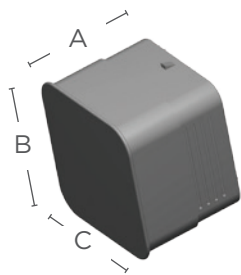

AEC Plug

AEC Receptacle

Cavity	Overall Length A	Overall Height B	Overall Width C	Overall Length D	Overall Height E	Overall Width F
40	1.440 (36.58)	1.778 (45.16)	1.894 (48.11)	1.642 (41.71)	1.944 (49.38)	1.828 (46.43)

Dimensions are for reference only.

CONFIGURATION

Keying Options

A	A key
B	B key
C	C key
D	D key
U	Universal key

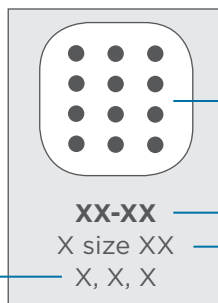

Insert Arrangement

Part Number

Number and Size of Cavities

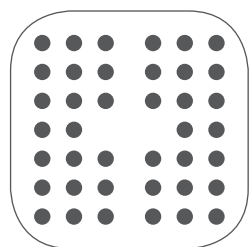

AEC1*-40***
40 size 16
A, B, C, D, U

Note

Do not over torque jackscrew.
The recommended torque rating for the AEC series plug jackscrew when tightening is 25-28 IN-LB (2.86-3.16 N.M.).

AEC Series

PART NUMBERING SYSTEM

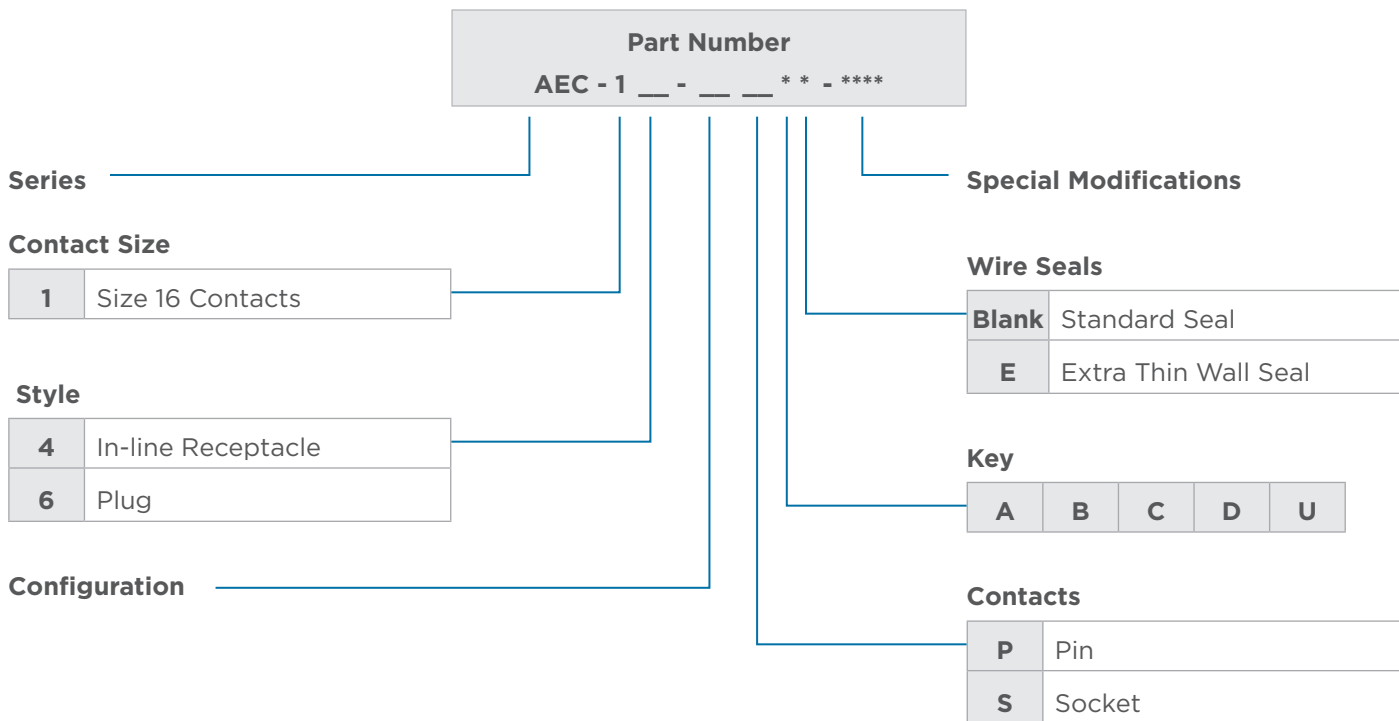

ORDERING INFORMATION

Here are some of the common part numbers in the AEC series. Several additional connectors may be available.

Position	Keying	Plug	Receptacle
40	A	AEC16-40SA	AEC14-40PA
	B	AEC16-40SB	AEC14-40PB
	C	AEC16-40SC	AEC14-40PC
	D	AEC16-40SD	AEC14-40PD

WIRE SEALING RANGES

The wire sealing range is the recommended outside diameter of the wire insulation required to maintain an environmental seal in the rear connector cavities.

Contact Size	Standard Seal	Thin Seal T-Seal	Extra Thin Seal E-Seal
16 14-20 AWG (2.0-0.5mm ²)	.100-.134 (2.54-3.40)	.088-.134 (2.23-3.40)	.053-.120 (1.35-3.05)

AEC Series

Accessories

Dust caps and boots are available for use with AEC series connectors. The dust caps are designed to help provide protection to the connector interface when the connector halves are not mated. The boots are aesthetically appealing and provide increased protection from dirt, paint overspray, and pressure washing.



Dust Cap Description

Dust Cap Description	Part Number
Dust cap, 40 way receptacle, environmentally sealed	0504-002-4001
Dust cap, 40 way receptacle, non-environmentally sealed	0515-009-4005
Dust cap, 40 way plug, non-environmentally sealed	0515-010-4005

Boot Description

Boot Description	Part Number
Boot, 40 way plug or receptacle, black, step-down	AEC40-BT-STPDWN

*Distorting the boots can lessen their longevity

How To Instructions

CONTACT INSERTION

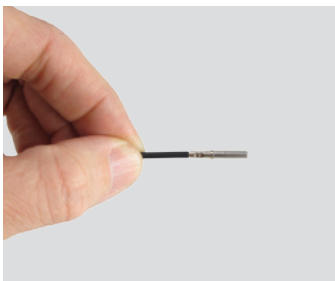

Step 1:
Grasp crimped contact approximately one inch behind the contact barrel.



Step 2:
Hold connector with rear grommet facing you.



Step 3:
Push contact straight into connector grommet until a click is felt. A slight tug will confirm that it is properly locked in place.

CONTACT REMOVAL

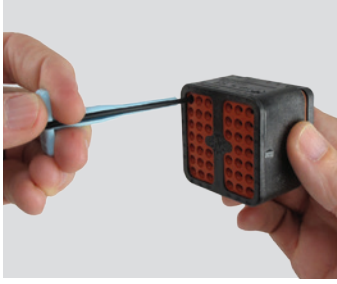

Step 1:
With rear insert toward you, snap appropriate size removal tool over the wire of contact to be removed.

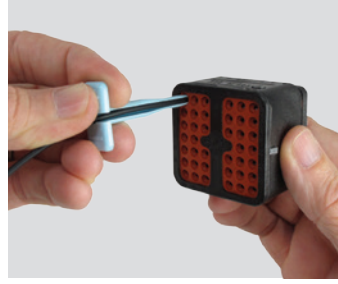

Step 2:
Slide tool along the wire into the insert cavity until it engages contact and resistance is felt.

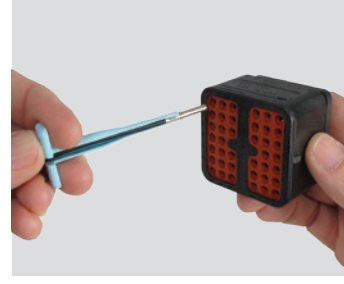

Step 3:
Pull contact wire assembly out of connector.

Contents

DRB Series Overview	92
Performance Specifications	92
Material Specifications	92
Dimensions	93
Configurations	93
Ordering Information	94
Required Components	95-96
Accessories	97
How To Instructions	97-98

DRB Series Overview

DEUTSCH DRB series connectors are heavy duty connectors suitable for bulkhead applications. They are designed to accommodate multiple wire gauges and feature high pin counts, including 48, 60, 102, and 128 cavities. To increase the design flexibility, the DRB series offers several mounting flange options and wire arrangements. The DRB series is suited for on- and off-highway applications, marine, industrial, and agriculture markets in harsh environments.



DEUTSCH CONNECTOR PERFORMANCE SPECIFICATIONS

Temperature:	Operating at temperatures -55°C to +125°C
Durability:	No electrical or mechanical defects after 100 cycles of engagement and disengagement.
Vibration:	No unlocking or unmating and exhibits no mechanical or physical damage after sinusoidal vibration levels of 20 G's at 10 to 2000 Hz in each of the three mutually perpendicular planes. No electrical discontinuities longer than 1 microsecond.
Fluid Resistance:	Connectors show no damage when exposed to most fluids used in industrial applications.
Insulation Resistance:	1000 megohms minimum at 25°C.
Immersion:	IP68 rating
Moisture Resistance:	Properly wired and mated connections will withstand immersion under three feet of water without loss of electronic qualities or leakage.
Dielectric Withstanding Voltage:	Current leakage less than 2 milliamps at 1500 volts AC.
Thermal Cycle:	No cracking, chipping or leaking after 20 test cycles from -55°C to +125°C.

MATERIAL SPECIFICATIONS

Flange Body:	Glass filled PA
Flange Clip:	Spring steel
Grommet:	Silicone rubber
Jackscrew:	Stainless steel
Shell:	Glass filled PA
Wedgelocks:	Glass filled PBT

DRB Series

DIMENSIONS

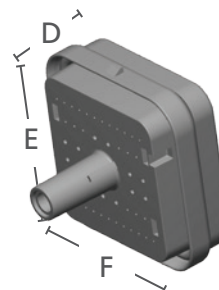
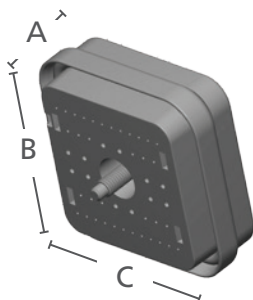

DRB Plug

DRB Receptacle

Cavity	Overall Length A	Overall Height B	Overall Width C	Overall Length D	Overall Height E	Overall Width F
48 & 60	1.406 (35.71)	2.606 (66.19)	2.606 (66.19)	2.077 (52.76)	2.606 (66.19)	2.606 (66.19)
102	1.778 (45.16)	2.966 (75.34)	4.951 (125.76)	2.291 (58.19)	2.966 (75.34)	4.951 (125.76)
128	1.748 (44.40)	2.966 (75.34)	4.951 (125.76)	2.291 (58.19)	2.966 (75.34)	4.951 (125.76)

Dimensions are for reference only.

CONFIGURATIONS

Keying Options

A	A key
B	B key
C	C key
D	D key

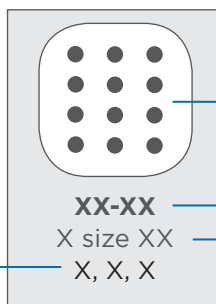

Insert Arrangement

Part Number

Number and Size of Cavities

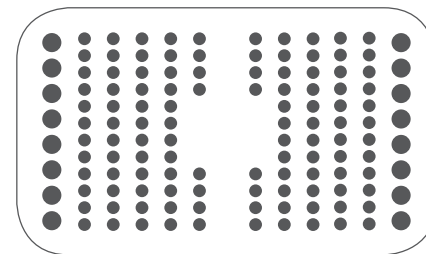
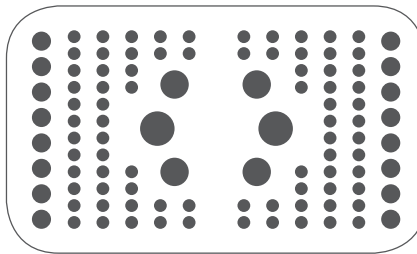
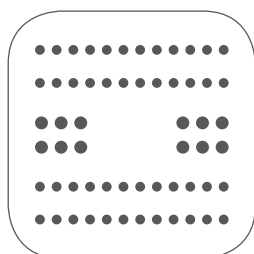

DRB1*-48**

12 size 12
12 size 16
24 size 20
A, B, C, D

DRB1*-60**

12 size 16
48 size 20
A, B, C, D

DRB1*-102***

2 size 4
4 size 8
16 size 12
80 size 16
A, B, C, D

DRB1*-128***

16 size 12
112 size 16
A, B, C, D

PART NUMBERING SYSTEM

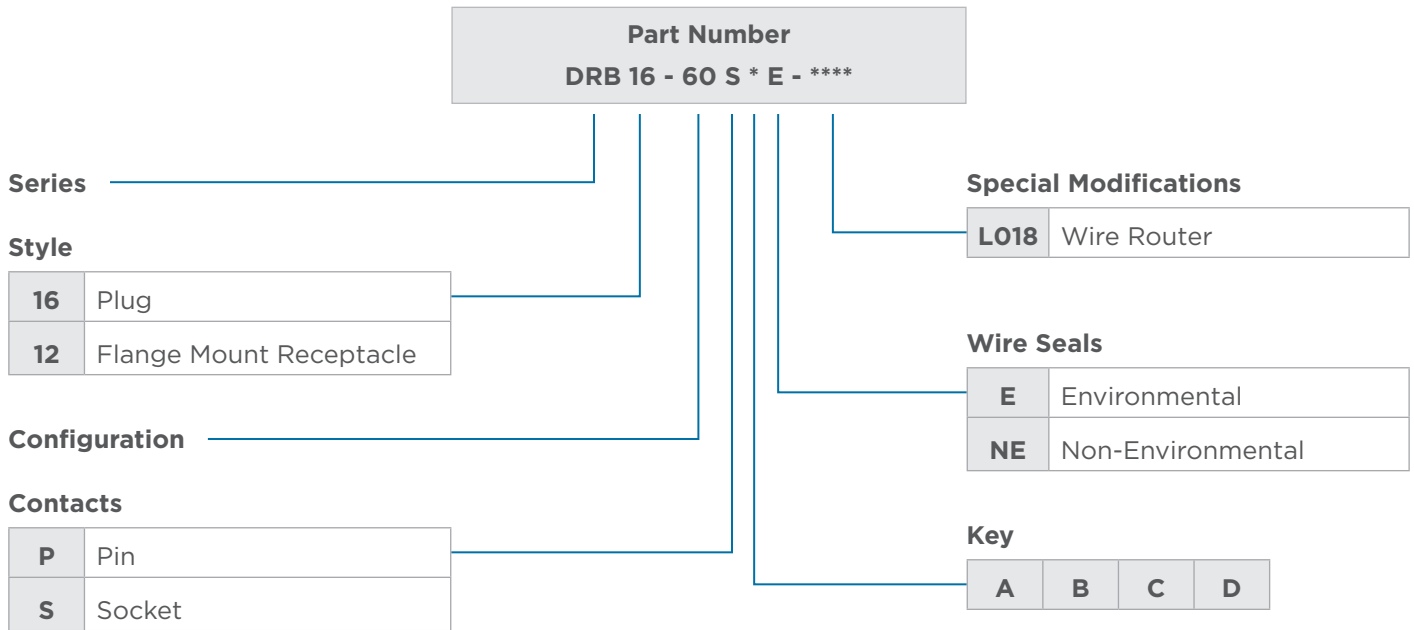

ORDERING INFORMATION

Here are some of the common part numbers in the DRB series. Several additional connectors may be available.

Position	Keying	Plug	Receptacle
48	Key A	DRB16-48SAE-L018	DRB12-48PAE-L018
	Key B	DRB16-48SBE-L018	DRB12-48PBE-L018
	Key C	DRB16-48SCE-L018	DRB12-48PCE-L018
	Key D	DRB16-48SDE-L018	DRB12-48PDE-L018
60	Key A	DRB16-60SAE-L018	DRB12-60PAE-L018
	Key B	DRB16-60SBE-L018	DRB12-60PBE-L018
	Key C	DRB16-60SCE-L018	DRB12-60PCE-L018
	Key D	DRB16-60SDE-L018	DRB12-60PDE-L018
102	Key A	DRB16-102SAE-L018	DRB12-102PAE-L018
	Key B	DRB16-102SBE-L018	DRB12-102PBE-L018
	Key C	DRB16-102SCE-L018	DRB12-102PCE-L018
	Key D	DRB16-102SDE-L018	DRB12-102PDE-L018
128	Key A	DRB16-128SAE-L018	DRB12-128PAE-L018
	Key B	DRB16-128SBE-L018	DRB12-128PBE-L018
	Key C	DRB16-128SCE-L018	DRB12-128PCE-L018
	Key D	DRB16-128SDE-L018	DRB12-128PDE-L018



DRB Series

WIRE SEALING RANGE

The wire sealing range is the recommended outside diameter of the wire insulation required to maintain an environmental seal in the rear connector cavities.

Contact Size	Standard Seal	Extra Thin Seal E-Seal
20 16-22 AWG (1.0-0.35mm ²)	.040-.095 (1.02-2.41)	.040-.095 (1.02-2.41)
16 14-20 AWG (2.0-0.5mm ²)	.100-.134 (2.54-3.40)	.053-.120 (1.35-3.05)
12 10-14 AWG (5.0-2.0mm ²)	.134-.170 (3.40-4.32)	.097-.158 (2.46-4.01)
8 8-10 AWG (8.0-5.0mm ²)	.190-.240 (4.83-6.10)	.135-.220 (3.43-5.59)
4 6 AWG (13.0mm ²)	.280-.292 (7.11-7.42)	.261-.292 (6.63-7.42)

Required Components

A complete DRB assembly requires a wedgelock for each plug and receptacle and a mounting flange. There are several flange options to accommodate design requirements. The wedgelocks are required to confirm proper contact placement.



FLANGE OPTIONS



Part Number	Accepts Connectors	Description
DRBF-2*	(1) DRB 48 or 60 way	Single mounting flange for one 48 or 60 way DRB plug and receptacle mated pair
DRBF-3**	(2) DRB 48 or 60 ways	Double mounting flange for any combination of two 48 or 60 way DRB plug and receptacle mated pairs
DRBF-1*	(1) DRB 102 way or (1) DRB 128 way	Single mounting flange for the 102 or 128 way DRB plug and receptacle mated pair
DRBM-3*	(1) DRB 102 way or (1) DRB 128 way	Single mounting flange for the 102 or 128 way DRB plug and receptacle mated pair, includes two 125 amp mounting posts

*A, B, C, D keying available, contact your representative

SECONDARY WEDGELOCKS

DEUTSCH DRB electrical connectors require secondary wedgelocks which are sold separately. The wedgelocks confirm proper contact alignment and offer keying options within each connector. Secondary wedgelocks are assembled at the mating interfaces and click into place.

Receptacle Wedgelocks

WB-48P*	Wedgelock for 48 way receptacle
WB-60P*	Wedgelock for 60 way receptacle
WB-51P*L	Left wedgelock for 102 way receptacle
WB-51P*R	Right wedgelock for 102 way receptacle
WB-64P*	Wedgelock for 128 way receptacle (requires two)

*A, B, C, D keying available

Plug Wedgelocks

WB-48S*	Wedgelock for 48 way plug
WB-60S*	Wedgelock for 60 way plug
WB-51S*L	Left wedgelock for 102 way plug
WB-51S*R	Right wedgelock for 102 way plug
WB-64S*	Wedgelock for 128 way plug (requires two)

*A, B, C, D keying available



DRB Series

Accessories

BOOTS



Boots provide a professional looking finishing touch for DEUTSCH DRB series connectors. Made of durable plastisol, these slip-on boots are not only aesthetically appealing, but also provide increased protection from dirt, paint overspray, and pressure washing. The plastisol boots are rated from -20°F to +212°F (-28°C to +100°C) and offer a slip-on design making installation quick and easy.



Part Number	Description
DRB48-60-BT	48 way plug or receptacle boot, black
DRB48-60-BT	60 way plug or receptacle boot, black
DRB102-BT	102/128 way plug or receptacle boot, black
DRB102-BT-90DEG	102/128 way plug or receptacle boot, 90° bend, black

*Distorting the boots can lessen their longevity

How To Instructions

CONTACT INSERTION

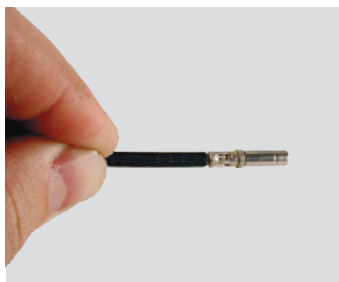

Step 1:
Hold connector with rear grommet/wire router cap facing you.

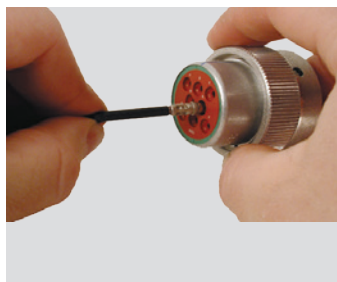

Step 2:
Push contact straight into contact cavity until a click is heard/felt. A slight tug will confirm the contact is inserted correctly.



Step 3:
Once all contacts are in place, insert wedge-lock by lining up the keyway. The wedge-lock will press into place.

CONTACT REMOVAL



Step 1:
Remove wedgelock using a screwdriver. Pull wedgelock straight out.



Step 2:
To remove contacts, gently pull wire backwards, while at the same time releasing the locking finger by moving it away from the contact with a screwdriver.

ASSEMBLY



Step 1:
Wedgelocks should be pressed firmly in place, with only a slight gap showing between the wedgelock and connector.



Step 2:
If the wedgelock will not go all the way in, check to make sure all of the contacts are properly seated.



Step 3:
Contacts should be fully inserted into the connector, with the locking fingers in place under the shoulder of the contact. If a contact is not fully inserted, the retention finger will prevent the wedgelock from pressing into place.

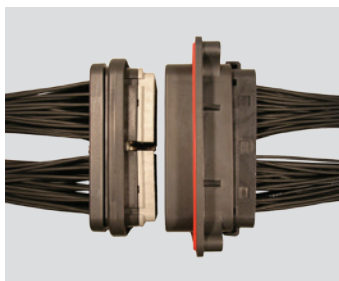

Step 4:
When mating the plug with the receptacle, confirm that the plug is not being pulled into the receptacle at an angle by the jackscrew.

Improper assembly can cause the jackscrew to be stripped during assembly. To prevent damage, the jackscrew will strip out before the threads in the connector are damaged. If the jackscrew becomes stripped, please replace the jackscrew and the push nut.

Note

Do not over torque jackscrew. The recommended torque rating for the DRB series plug jackscrew when tightening is 30-35 IN-LB (3.38-3.95 N.M.).

Contents

DRC Series Overview.....	100
Performance Specifications	100
Material Specifications.....	100
Dimensions	101
Configurations.....	102
Ordering Information.....	103-104
Accessories.....	106-107
How To Instructions	108

DRC Series Overview

The environmentally sealed DEUTSCH DRC series is a rectangular connector series that offers insert arrangements of 24, 40, 50, 60, 64, 70, and 76 cavities and accepts size 12, 16, and 20 contacts. Several mounting options are available including in-line, flange mount, and PCB mount.



DEUTSCH CONNECTOR PERFORMANCE SPECIFICATIONS

Temperature:	Operating at temperatures -55°C to +125°C
Durability:	No electrical or mechanical defects after 100 cycles of engagement and disengagement.
Vibration:	No unlocking or unmating and exhibits no mechanical or physical damage after sinusoidal vibration levels of 20 G's at 10 to 2000 Hz in each of the three mutually perpendicular planes. No electrical discontinuities longer than 1 microsecond.
Fluid Resistance:	Connectors show no damage when exposed to most fluids used in industrial applications.
Insulation Resistance:	1000 megohms minimum at 25°C.
Immersion:	IP68 rating
Moisture Resistance:	Properly wired and mated connections will withstand immersion under three feet of water without loss of electronic qualities or leakage.
Dielectric Withstanding Voltage:	Current leakage less than 2 milliamps at 1500 volts AC.
Thermal Cycle:	No cracking, chipping or leaking after 20 test cycles from -55°C to +125°C.

MATERIAL SPECIFICATIONS

Grommet:	Silicone rubber
Insert Retainer:	Unfilled PEI
Jackscrew:	Stainless steel
Receptacle Threaded Inserts:	Stainless steel/Brass
Shell:	Glass filled PA, Glass filled PPS

DRC Series

DIMENSIONS

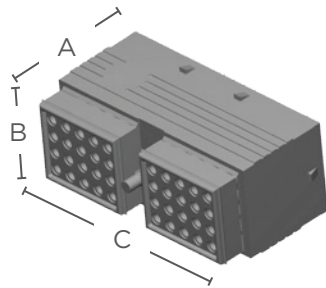

DRC Plug

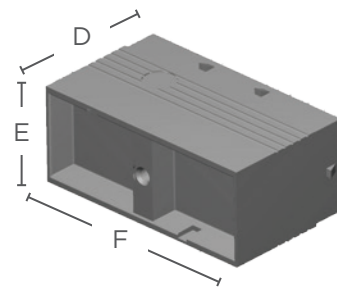

DRC Receptacle

Cavity	Overall Length A	Overall Height B	Overall Width C	Overall Length D	Overall Height E	Overall Width F
24 (sz. 20)	1.435 (36.45)	1.244 (31.60)	2.004 (50.90)	1.785 (45.34)	1.500 (38.10)	3.104 (78.84)
24 (sz. 16)	1.600 (40.64)	1.148 (29.16)	2.100 (53.34)	1.742 (44.25)	1.202 (30.53)	2.154 (54.71)
38	1.435 (36.45)	1.274 (32.36)	2.700 (68.58)	-	-	-
40 (sz. 20)	1.380 (35.05)	1.244 (31.60)	2.700 (68.58)	1.785 (45.34)	1.500 (38.10)	3.800 (96.52)
40 (sz. 16)	1.597 (40.56)	1.202 (30.53)	2.868 (72.85)	1.699 (43.15)	1.202 (30.53)	2.908 (73.86)
50	1.435 (36.45)	1.408 (35.76)	2.700 (68.58)	-	1.987 (50.47)	3.094 (78.59)
60	1.435 (36.45)	1.448 (36.78)	2.700 (68.58)	-	2.161 (54.89)	3.094 (78.59)
64	-	-	-	1.785 (45.34)	1.500 (38.10)	5.866 (149.00)
70	1.643 (41.73)	1.421 (36.09)	4.094 (103.99)	1.757 (44.63)	1.421 (36.09)	4.094 (103.99)
76	-	-	-	1.115 (28.32)	1.827 (46.41)	5.686 (144.42)

Dimensions are for reference only.

CONNECTOR STYLES

In-line
Receptacle

Flange Mount
Receptacle

PCB Receptacle

Standard Plug

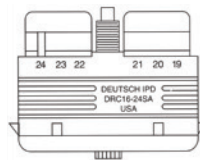
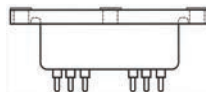
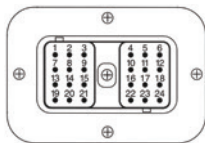
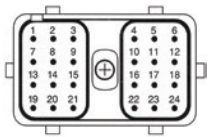

CONFIGURATIONS

Connector Styles

I	In-line
F	Flange Mount Receptacle
P	PCB Receptacle

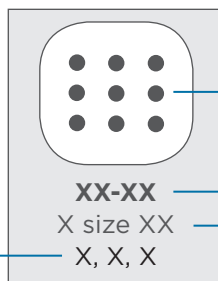

Insert Arrangement

Part Number

Number and Size of Cavities

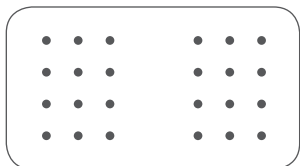

DRC2*-24**
24 size 20
I, F, P

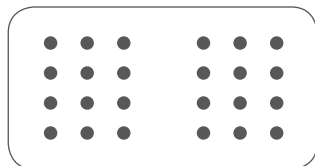

DRC1*-24**
24 size 1
I, F, P

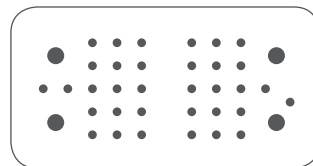

DRC26-38**
34 size 20, 4 size 12
(Plug for **DRC20-76P******)

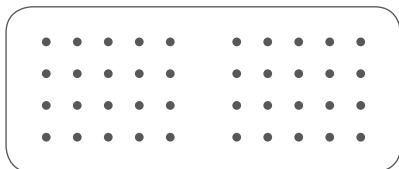

DRC2*-40**
40 size 20
F, P

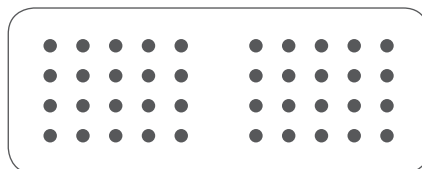

DRC1*-40**
40 size 16
I, F, P

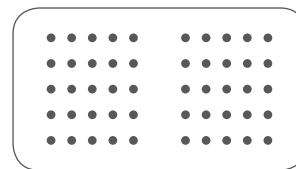

DRC2*-50**
50 size 20
P

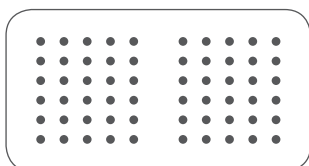

DRC2*-60**
60 size 20
P

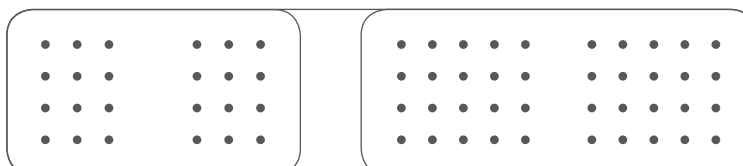

DRC2*-64**
64 size 20
P

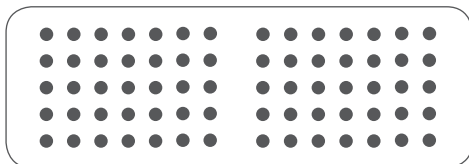

DRC1*-70**
70 size 16
I, F, P

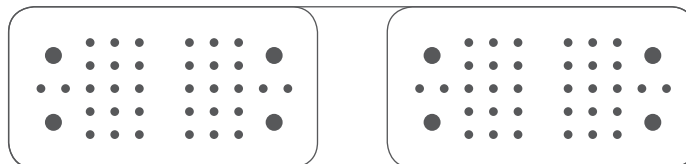

DRC20-76P****
68 size 20, 8 size 12
P

DRC Series

PART NUMBERING SYSTEM

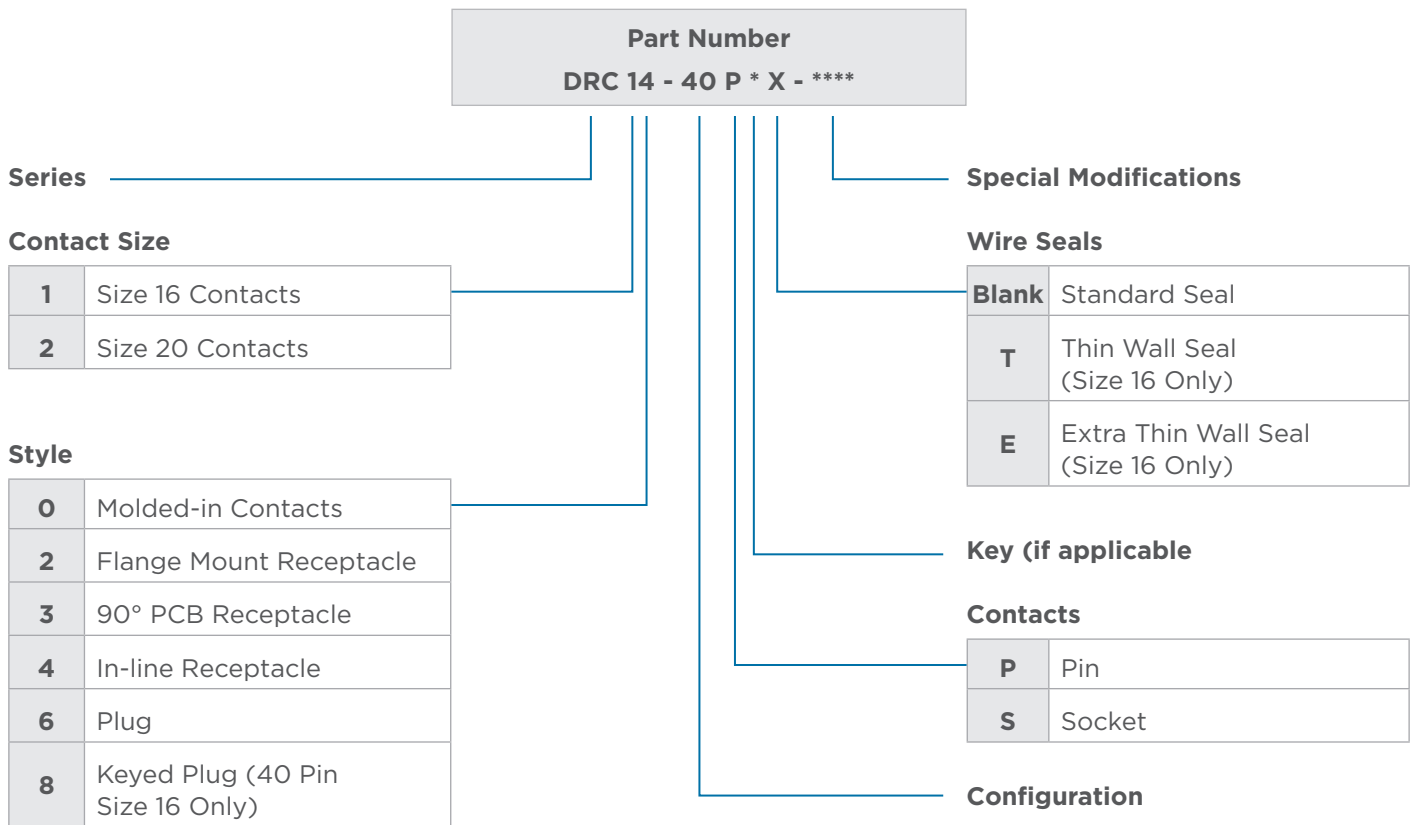

ORDERING INFORMATION

Here are some of the common part numbers in the DRC series. Several additional connectors may be available.

Position	Key	Plug	Receptacle In-line	Receptacle Flange	Receptacle PCB
24 (sz. 20)	A	DRC26-24SA	-	-	DRC23-24PA (90°)
	B	DRC26-24SB	-	-	DRC23-24PB (90°)
	C	DRC26-24SC	-	-	DRC23-24PC (90°)
	D	DRC26-24SD	-	-	DRC23-24PD (90°)
24 (sz. 16)	A	DRC16-24SA	DRC14-24PA	DRC12-24PA	DRC10-24PA (180°)
					DRC13-24PA (90°)
	B	DRC16-24SB	DRC14-24PB	DRC12-24PB	DRC10-24PB (180°)
					DRC13-24PB (90°)
	C	DRC16-24SC	DRC14-24PC	DRC12-24PC	DRC10-24PC (180°)
					DRC13-24PC (90°)
	D	DRC16-24SD	DRC14-24PD	DRC12-24PD	DRC10-24PD (180°)
					DRC13-24PD (90°)
38 (sz. 20)	01	DRC26-38S01-P017	-	-	DRC20-76P0102 (180°)
	02	DRC26-38S02-P017	-	-	

ORDERING INFORMATION (CONTINUED)

Position	Key	Plug	Receptacle In-line	Receptacle Flange	Receptacle PCB
40 (sz. 20)	A	DRC26-40SA	-	DRC22-40PA	DRC23-40PA (90°)
	B	DRC26-40SB	-	DRC22-40PB	DRC23-40PB (90°)
	C	DRC26-40SC	-	DRC22-40PC	DRC23-40PC (90°)
	D	DRC26-40SD	-	DRC22-40PD	DRC23-40PD (90°)
40 (sz. 16)	A	DRC18-40SA	DRC14-40PA	DRC12-40PA	DRC10-40PA (180°)
					DRC13-40PA (90°)
	B	DRC18-40SB	DRC14-40PB	DRC12-40PB	DRC10-40PB (180°)
					DRC13-40PB (90°)
	C	DRC18-40SC	DRC14-40PC	DRC12-40PC	DRC10-40PC (180°)
					DRC13-40PC (90°)
	D	DRC18-40SD	DRC14-40PD	DRC12-40PD	DRC10-40PD (180°)
					DRC13-40PD (90°)
50 (sz. 20)	01	DRC26-50S01	-	-	DRC20-50P01 (180°, outside mount)
					DRC22-50P01 (180°, inside mount)
	02	DRC26-50S02	-	-	DRC20-50P02 (180°, outside mount)
					DRC22-50P02 (180°, inside mount)
	03	DRC26-50S03	-	-	DRC20-50P03 (180°, outside mount)
					DRC22-50P03 (180°, inside mount)
	04	DRC26-50S04	-	-	DRC20-50P04 (180°, outside mount)
					DRC22-50P04 (180°, inside mount)
60 (sz. 20)	05	DRC26-60S05	-	-	-
	06	DRC26-60S06	-	-	-
	07	DRC26-60S07	-	-	-
64 (sz. 20)	AA	DRC26-24SA/ DRC26-40SA	-	-	DRC23-64PAA (90°)
70 (sz. 16)	A	DRC16-70SA	DRC14-70PA	DRC12-70PA	DRC13-70PA
	B	DRC16-70SB	DRC14-70PB	DRC12-70PB	DRC13-70PB
	C	DRC16-70SC	DRC14-70PC	DRC12-70PC	DRC13-70PC
	D	DRC16-70SD	DRC14-70PD	DRC12-70PD	DRC13-70PD
76 (sz. 20 and sz. 12)	01/02	DRC26-38S01-P017/ DRC26-38S02-P017	-	-	DRC20-76P0102 (180°)

DRC Series

WIRE SEALING RANGE

The wire sealing range is the recommended outside diameter of the wire insulation required to maintain an environmental seal in the rear connector cavities.

Contact Size	Standard Seal	Thin Seal T-Seal	Extra Thin Seal E-Seal
20 16-22 AWG (1.0-0.35mm ²)	.040-.095 (1.02-2.41)	.040-.095 (1.02-2.41)	.040-.095 (1.02-2.41)
16 14-20 AWG (2.0-0.5mm ²)	.100-.134 (2.54-3.40)	.088-.134 (2.23-3.40)	.053-.120 (1.35-3.05)
12 10-14 AWG (6.0-2.0mm ²)	.097-.170 (2.46-4.95)	.113-.170 (2.87-4.32)	.097-.158 (2.46-4.01)

MATING CRITERIA

DEUTSCH DRC series plugs are keyed to provide positive alignment and to prevent mis-mating.

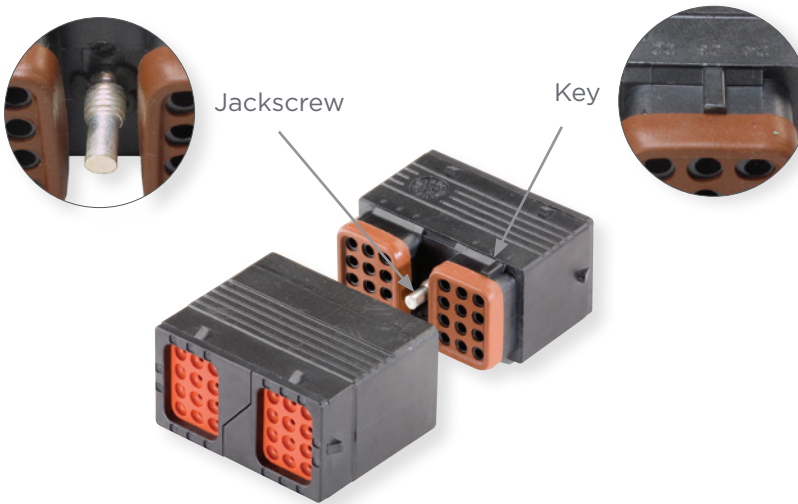

Note

Do not over torque jackscrew.
The recommended torque rating for the DRC series plug jackscrew when tightening is 25-28 IN-LB (2.82-3.16 N.M.).

Accessories

Several accessory items are available to complement the connectors including boots, gaskets, backshells, and wire routers. Accessories are designed to complete the application and meet a wide array of design requirements such as providing additional protection and offering increased aesthetics.

BACKSHELLS

DEUTSCH DRC series backshells are designed to snap onto the back of the connectors and accept convoluted tubing. The rigid, durable backshells offer a high level of protection, provide strain relief, and improve aesthetics.



Connector Cavities	Part Number	Description
38	0528-003-3805	90° backshell to the side, plug
38	0528-004-3805	90° backshell, plug
38	0528-005-3805	90° low profile backshell, plug
40	0515-015-4005	Wire router, plug
50	0528-001-5005	90° backshell, plug
60	0528-002-6005	90° backshell, plug
60	0528-007-6005	90° backshell to the side, plug
70	0515-029-7005	Straight wire router, plug
70	0515-031-7005	Straight wire router, plug or receptacle,
70	0528-006-7005	Straight backshell, plug or receptacle, requires two halves and wire router
70	0528-012-7005	90° backshell to the side, plug or receptacle, without tubing rib

DRC Series

BOOTS



Boots provide a professional looking finishing touch for DEUTSCH DRC series connectors. Made of durable plastisol, these slip-on boots are not only aesthetically appealing, but also provide increased protection from dirt, paint overspray, and pressure washing. The plastisol boots are rated from -20°F to +212°F (-28°C to +100°C) and offer a slip-on design making installation quick and easy.



Part Number	Description
DRC24-BT	24 way boot, size 16 contact arrangements, black
DRC26-24BT	24 way boot, size 20 contact arrangements, black
DRC40-BT	40 way boot, size 16 contact arrangements, black
DRC40-BT-90DEG	40 way boot, size 16 contact arrangements, 90° bend, black
DRC26-40BT	40 way boot, size 20 contact arrangements, black
DRC70-BT	70 way boot, size 16 contact arrangements, black

*Distorting the boots can lessen their longevity

GASKETS



Moisture, dirt, salt, sand, and road debris can all work their way into electrical panels through unsealed mounting flanges. Rated to operate in environments from -70°F to +225 F (-56°C to +107°C), these rugged high quality neoprene gaskets form a tight seal between the panel face and connector flange to help keep out destructive elements. The gaskets have a thickness of .125" and the material meets the UL-94-HBF, Mil-R-6130C, and FMVSS-302 flammability specifications.



Gasket Part Number	Connector Part Number
DRC24-GKT	DRC12-24P**
DRC40-GKT	DRC12-40P**
DRC70-GKT	DRC12-70P**

How To Instructions

CONTACT INSERTION

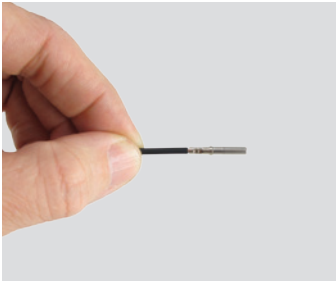

Step 1:
Grasp crimped contact approximately one inch behind the contact barrel.

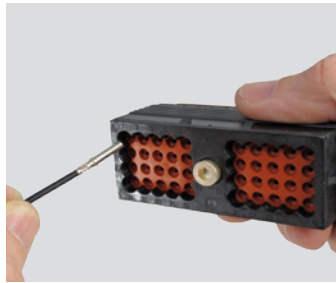

Step 2:
Hold connector with rear grommet facing you.

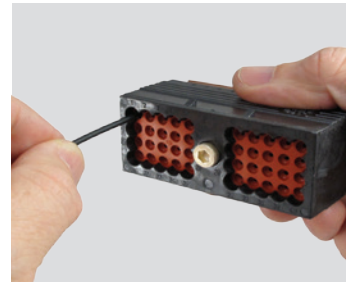

Step 3:
Push contact straight into connector grommet until a click is felt. A slight tug will confirm that it is properly locked in place.

CONTACT REMOVAL



Step 1:
With rear insert toward you, snap appropriate size removal tool over the wire of contact to be removed.



Step 2:
Slide tool along the wire into the insert cavity until it engages contact and resistance is felt.

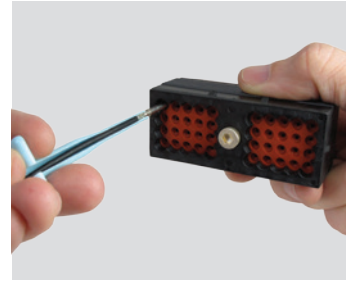

Step 3:
Pull contact wire assembly out of connector.

Contents

DT Family Overview	110
Product Documentation	111
Performance Specifications	111
Material Specifications	111
Dimensions	112-113
Configurations	114
Ordering Information	115-116
Required Components	117-118
Special Modifications	118-120
Accessories	121-127
DT Family Printed Circuit Board	128
DTMH Series & High Temperature Modification	129-130
DTV Series	131
How To Instructions	132

DT Family

DT Family Overview

DEUTSCH DT, DTM, and DTP series environmentally sealed connectors are designed for cable to cable and cable to board applications. The DT connectors are used in harsh environment applications where even a small degradation in connection may be critical. Thermoplastic housings offer a wide operating temperature range and silicone rear wire and interface seals allow the connectors to withstand conditions of extreme temperature and moisture.

The DEUTSCH DT series general purpose connectors will provide reliability and performance on the engine or transmission, under the hood, on the chassis, or in the cab.



DT SERIES OVERVIEW

DEUTSCH DT series connectors offer field proven reliability and rugged quality. The DT design strengths include optional flange mounting, multi-pin arrangements, and design flexibility. The DT series offers the designer the ability to use multiple size 16 contacts, each with 13 amp continuous capacity, within a single shell.

DTM SERIES OVERVIEW

DEUTSCH DTM series connectors offer solutions to your smaller wire gauge applications. Building on the DT design strengths, the DTM connector line was developed to fill the need for lower amperage, multi-pin connectors. The DTM series offers the designer the ability to use multiple size 20 contacts, each with 7.5 amp continuous capacity, within a single shell.

DTP SERIES OVERVIEW

DEUTSCH DTP series connectors provide solutions for your power application requirements. Building on both the DT and DTM design strengths, the DTP connector line was developed to fill the need for higher amperage, multi-pin connectors.

The DTP series offers the designer the ability to use multiple size 12 contacts, each with 25 amp continuous capacity, within a single shell. The DTP connectors are currently available in two and four pin configurations.

DT Family

APPLICABLE PRODUCT DOCUMENTATION

Additional documentation is available for assistance with DT Family products. The following TE Connectivity document numbers may be helpful:

108-151009 (Product Specification, DT series)
108-151010 (Product Specification, DTM series)

DEUTSCH CONNECTOR PERFORMANCE SPECIFICATIONS

Temperature:	Operating at temperatures -55°C to +125°C • DTMH series: -55°C to +150°C
Durability:	No electrical or mechanical defects after 100 cycles of engagement and disengagement.
Vibration:	No unlocking or unmating and exhibits no mechanical or physical damage after sinusoidal vibration levels of 20 G's at 10 to 2000 Hz in each of the three mutually perpendicular planes. No electrical discontinuities longer than 1 microsecond.
Fluid Resistance:	Connectors show no damage when exposed to most fluids used in industrial applications.
Insulation Resistance:	1000 megohms minimum at 25°C.
Immersion:	IP68 rating
Moisture Resistance:	Properly wired and mated connections will withstand immersion under three feet of water without loss of electronic qualities or leakage.
Dielectric Withstanding Voltage:	Current leakage less than 2 milliamps at 1500 volts AC.
Thermal Cycle:	No cracking, chipping or leaking after 20 test cycles from -55°C to +125°C.

MATERIAL SPECIFICATIONS (DT, DTM, DTMH, DTP, DTV SERIES)

Grommet:	Silicone rubber
Receptacle Interfacial Seal:	Silicone rubber
Receptacle Threaded Inserts:	Stainless steel
Shell:	Glass filled PA
Wedgelocks:	Glass filled PBT

DT SERIES DIMENSIONS

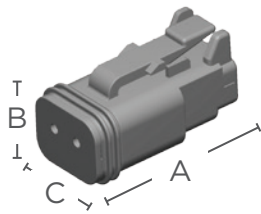

DT Plug

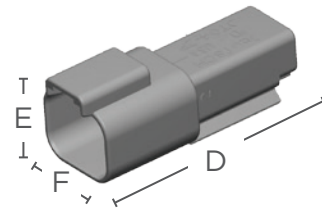

DT Receptacle

Cavity	Overall Length A	Overall Height B	Overall Width C	Overall Length D	Overall Height E	Overall Width F
2	1.118 (28.4)	.628 (15.95)	.591 (15.01)	1.708 (43.38)	.670 (17.02)	.675 (17.15)
3	1.118 (28.4)	.934 (23.72)	.718 (18.23)	1.698 (43.13)	.973 (24.71)	.832 (21.13)
4	1.218 (30.94)	.724 (18.39)	.716 (18.19)	1.808 (45.92)	.776 (19.71)	.820 (20.83)
6	1.218 (30.94)	.891 (22.63)	.716 (18.19)	1.808 (45.92)	.951 (24.16)	.820 (20.83)
8	1.217 (30.91)	.776 (19.71)	1.465 (37.21)	1.798 (45.67)	1.000 (25.40)	1.435 (36.45)
12	1.218 (30.94)	.716 (18.19)	1.597 (40.56)	1.808 (45.92)	.876 (22.25)	1.597 (40.56)

Dimensions are for reference only.

DTM SERIES DIMENSIONS

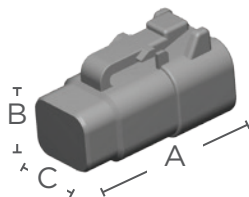

DTM Plug

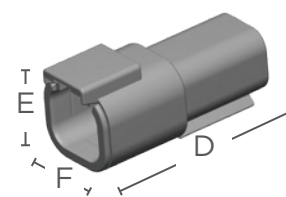

DTM Receptacle

Cavity	Overall Length A	Overall Height B	Overall Width C	Overall Length D	Overall Height E	Overall Width F
2	1.085 (27.56)	.508 (12.90)	.475 (12.07)	1.620 (41.15)	.638 (16.21)	.651 (16.54)
3	1.085 (27.56)	.551 (14.00)	.640 (16.26)	1.620 (41.15)	.638 (16.21)	.861 (20.73)
4	1.185 (30.10)	.695 (17.65)	.600 (15.24)	1.720 (43.69)	.772 (19.61)	.756 (19.20)
6	1.185 (30.10)	.817 (20.75)	.600 (15.24)	1.720 (43.69)	.937 (23.80)	.756 (19.20)
8	1.185 (30.10)	.600 (15.24)	1.245 (31.62)	1.720 (43.69)	.796 (20.22)	1.245 (31.62)
12	1.185 (30.10)	.600 (15.24)	1.575 (40.01)	1.720 (43.69)	.796 (20.22)	1.575 (40.01)

Dimensions are for reference only.

DTP SERIES DIMENSIONS

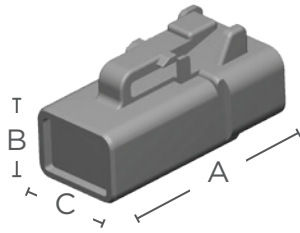

DTP Plug

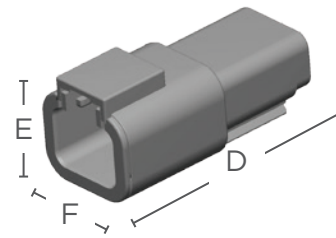

DTP Receptacle

Cavity	Overall Length A	Overall Height B	Overall Width C	Overall Length D	Overall Height E	Overall Width F
2	1.364 (34.65)	.711 (18.06)	.732 (18.59)	1.861 (47.27)	.869 (22.07)	.872 (22.15)
4	1.364 (34.65)	.960 (24.38)	.868 (22.05)	1.861 (47.27)	1.048 (26.62)	1.060 (26.92)

Dimensions are for reference only.

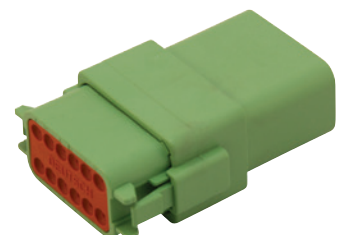

DT Family

DT FAMILY CONFIGURATIONS

Keying Options

A	A key
B	B key
C	C key
D	D key

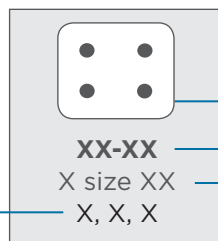

Insert Arrangement

Part Number

Number and Size of Cavities

DT SERIES CONFIGURATIONS

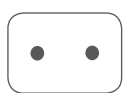

DT0*-2*
2 size 16



DT0*-3*
3 size 16



DT0*-4*
4 size 16

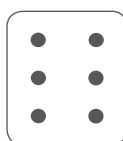

DT0*-6*
6 size 16

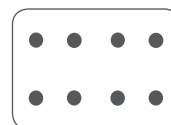

DT0*-08**
8 size 16
A, B, C, D

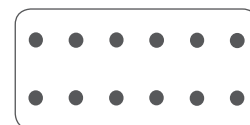

DT0*-12**
12 size 16
A, B, C, D

DTM SERIES CONFIGURATIONS

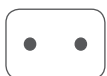

DTM0*-2*
2 size 20



DTM0*-3*
3 size 20

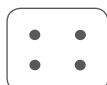

DTM0*-4*
4 size 20

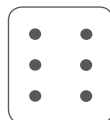

DTM0*-6*
6 size 20

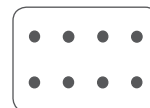

DTM0*-08**
8 size 20
A, B, C, D

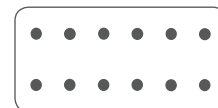

DTM0*-12**
12 size 20
A, B, C, D

DTP SERIES CONFIGURATIONS



DTPO*-2*
2 size 12

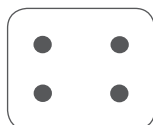

DTPO*-4*
4 size 12

PART NUMBERING SYSTEM

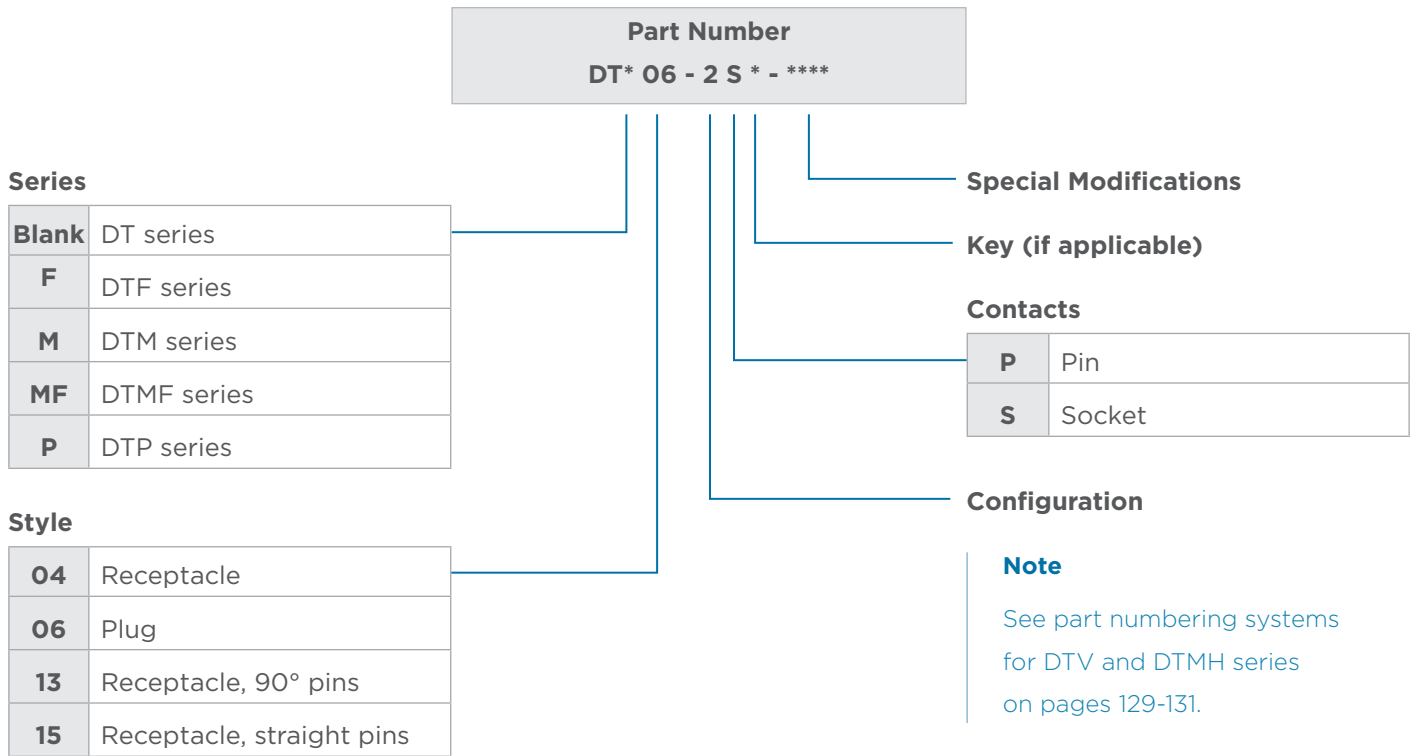

DT SERIES ORDERING INFORMATION

Here are some of the common part numbers in the DT series. Several additional connectors may be available.

Position	Keying	Plug	Receptacle	Plug Reduced Dia. Seals	Receptacle Reduced Dia. Seals
2	-	DT06-2S	DT04-2P	DT06-2S-C015	DT04-2P-C015
3	-	DT06-3S	DT04-3P	DT06-3S-C015	DT04-3P-C015
4	-	DT06-4S	DT04-4P	DT06-4S-C015	DT04-4P-C015
6	-	DT06-6S	DT04-6P	DT06-6S-C015	DT04-6P-C015
8	Key A	DT06-08SA	DT04-08PA	DT06-08SA-C015	DT04-08PA-C015
	Key B	DT06-08SB	DT04-08PB	DT06-08SB-C015	DT04-08PB-C015
	Key C	DT06-08SC	DT04-08PC	DT06-08SC-C015	DT04-08PC-C015
	Key D	DT06-08SD	DT04-08PD	DT06-08SD-C015	DT04-08PD-C015
12	Key A	DT06-12SA	DT04-12PA	DT06-12SA-C015	DT04-12PA-C015
	Key B	DT06-12SB	DT04-12PB	DT06-12SB-C015	DT04-12PB-C015
	Key C	DT06-12SC	DT04-12PC	DT06-12SC-C015	DT04-12PC-C015
	Key D	DT06-12SD	DT04-12PD	DT06-12SD-C015	DT04-12PD-C015

DTM SERIES ORDERING INFORMATION

Here are some of the common part numbers in the DTM series. Several additional connectors may be available.

Position	Keying	Plug	Receptacle
2	-	DTM06-2S	DTM04-2P
3	-	DTM06-3S	DTM04-3P
4	-	DTM06-4S	DTM04-4P
6	-	DTM06-6S	DTM04-6P
8	Key A	DTM06-08SA	DTM04-08PA
	Key B	DTM06-08SB	DTM04-08PB
	Key C	DTM06-08SC	DTM04-08PC
	Key D	DTM06-08SD	DTM04-08PD
12	Key A	DTM06-12SA	DTM04-12PA
	Key B	DTM06-12SB	DTM04-12PB
	Key C	DTM06-12SC	DTM04-12PC
	Key D	DTM06-12SD	DTM04-12PD

DTP SERIES ORDERING INFORMATION

Here are some of the common part numbers in the DTP series. Several additional connectors may be available.

Position	Plug	Receptacle	Plug Reduced Dia. Seals	Receptacle Reduced Dia. Seals
2	DTP06-2S	DTP04-2P	DTP06-2S-C015	DTP04-2P-C015
4	DTP06-4S	DTP04-4P	DTP06-4S-C015	DTP04-4P-C015

WIRE SEALING RANGE

The wire sealing range is the recommended outside diameter of the wire insulation required to maintain an environmental seal in the rear connector cavities.

Contact Size	Standard Seal	Extra Thin Seal E-Seal
20 14-22 AWG (2.5-0.35mm ²)	.053-.120 (1.35-3.05)	-
16 14-20 AWG (2.0-0.5mm ²)	.088-.145 (2.23-3.68)	.053-.120 (1.35-3.05)
12 10-14 AWG (6.0-2.0mm ²)	.134-.170 (3.40-4.32)	.097-.158 (2.46-4.01)

Required Components

SECONDARY WEDGELOCKS

DEUTSCH DT style electrical connectors require secondary wedgelocks which are sold separately. The wedgelocks help confirm proper contact alignment within each connector. Secondary wedgelocks are assembled at the mating interface and press into place. If by chance the secondary wedgelocks are not properly seated during assembly, they will be pressed into locked position during the mating of the connector.

Adding to the design flexibility of the DT series, several wedgelocks offer keying options. Wedgelocks for enhanced seal retention plugs (P012) are also available.

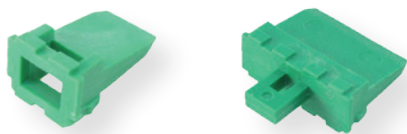

DT Series Receptacle Wedgelocks

W2P*	Wedgelock for 2 way receptacle *A, B, C, D keying available
W3P*	Wedgelock for 3 way receptacle *J1939 keying available
W4P*	Wedgelock for 4 way receptacle *A, B, C, D keying available
W6P	Wedgelock for 6 way receptacle
W8P	Wedgelock for 8 way receptacle
W12P	Wedgelock for 12 way receptacle

DT Series Plug Wedgelocks

W2S*	Wedgelock for 2 way plug *A, B, C, D keying available
W3S*	Wedgelock for 3 way plug *J1939 keying available
W4S*	Wedgelock for 4 way plug *A, B, C, D keying available
W6S	Wedgelock for 6 way plug
W8S	Wedgelock for 8 way plug
W12S	Wedgelock for 12 way plug

Note

Wedgelocks for enhanced seal retention plugs (P012) are available.

DT Family



DTM Series Receptacle Wedgelocks

WM-2P*	Wedgelock for 2 way receptacle *A, B, C, D keying available
WM-3P	Wedgelock for 3 way receptacle
WM-4P	Wedgelock for 4 way receptacle
WM-6P	Wedgelock for 6 way receptacle
WM-8P	Wedgelock for 8 way receptacle
WM-12P	Wedgelock for 12 way receptacle



DTM Series Plug Wedgelocks

WM-2S*	Wedgelock for 2 way plug *A, B, C, D keying available
WM-3S	Wedgelock for 3 way plug
WM-4S	Wedgelock for 4 way plug
WM-6S	Wedgelock for 6 way plug
WM-8S	Wedgelock for 8 way plug
WM-12S	Wedgelock for 12 way plug



DTP Series Receptacle Wedgelocks

WP-2P	Wedgelock for 2 way receptacle
WP-4P	Wedgelock for 4 way receptacle



DTP Series Plug Wedgelocks

WP-2S	Wedgelock for 2 way plug
WP-4S	Wedgelock for 4 way plug

Special Modifications

The DT series connectors offer several modifications to enhance the design flexibility and meet application specific needs. Options include enhanced seal retention, flanges, and connector body color just to mention a few. By combining the DT series connectors with the available modifications and accessories, the design possibilities are immense.

B016 MODIFICATION

The B016 receptacle modification helps prevent mis-mating. The B016 is available for the DT 12 way connectors, DT13/15, and DTF13/15 PCB series connectors. In addition to the four keying positions (A, B, C, or D) and color coding, the B016 enhancement gives the user both visual and tactile proof of correct mating, thus helping eliminate mis-mating opportunities during assembly.

Please note the P012 plug is the required mate for the B016 receptacle to make the enhancement effective.

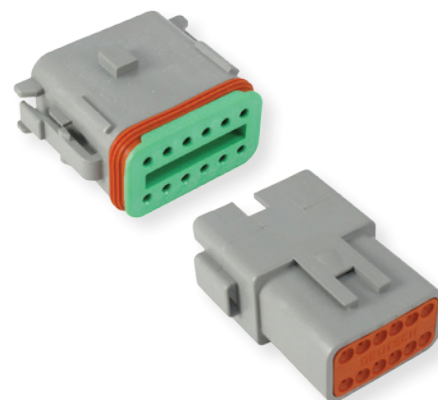

DETECTOR

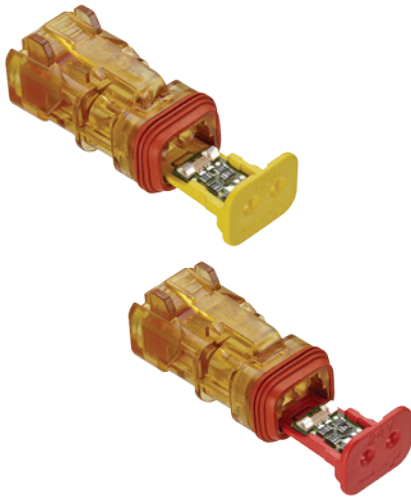

The Detector connector has an integrated LED used for diagnostics. The transparent housing features reduced diameter seals and may be ordered with or without an end cap. Color coded wedgelocks for operating voltages, 12VDC and 24VDC are available.

Description	Part Number
Plug, 2 way, LED, transparent Ultem material, reduced diameter seals, end cap	DT06-2S-SDT-CE27
Plug, 2 way, LED, transparent Ultem material, reduced diameter seals	DT06-2S-SDT-CE28
Wedgelock, LED, 12V, yellow	W2S-SDT-12V
Wedgelock, LED, 24V, red	W2S-SDT-24V

P012 MODIFICATION



The DT P012 plugs provide enhanced front seal retention resulting in an ultra tight environmental seal. The enhanced seal retention keeps the seal in place during mating and unmating. The P012 modification requires an enhanced P012 wedgelock. The DEUTSCH P012 modification is available in 2, 3, 4, 6, 8, and 12 cavity arrangements. P012 plugs have a black connector body except for the 8 and 12 cavity arrangements, where the color is based on the key.

C015 MODIFICATION



The C015 modification offers a reduced diameter insert cavity allowing for a proper seal with smaller wire insulation. The C015 modification is also referred to as an "E" seal.

E003 MODIFICATION



The E003 modification offers a protective end cap attached to the rear of the connector. There are holes in the cap to allow the contacts to be inserted.



E004 MODIFICATION

The E004 modification changes the connector body color to black.



E005 MODIFICATION

The E005 modification offers a protective end cap attached to the rear of the connector and has a black connector body.



E007 & E008 MODIFICATION

To meet the application requirements where wires need added protection, the DT (E008) and DTM (E007) series may be supplied with shrink boot adapters. These adapters accept shrink tubing.



FLANGE MODIFICATIONS

Designed to simplify wire routing and assembly, DT series receptacles are available in many mounting configurations and styles.

Welded flange

- Welded flange - BL04, BL08, CL03, LO12, LE14
- Welded flange, end cap - LE07, LE11
- Welded flange, shrink boot adapter - LE08, LE12

Sealed flange

- Sealed flange, end cap - CL09, LE01, LE05, LE06, LE09, LE10, LE17, LE21
- Sealed flange, shrink boot adapter - BL10, CL07

Note

Additional modifications are available, please contact your representative.

DT Family

Accessories

Several accessory items are available to complement the connectors including boots, backshells, gaskets, dust caps, and mounting clips. Accessory items cover a wide array of design requirements such as assisting with mounting, providing additional protection, and offering enhanced aesthetics.

GASKETS



Moisture, dirt, salt, sand, and road debris can all work their way into electrical panels through unsealed mounting flanges. Rated to operate in environments from -70°F to +225°F (-56°C to +107°C), these rugged high quality neoprene gaskets form a tight seal between the panel face and connector flange to help keep out destructive elements. The gaskets have a thickness of .125" and the material meets the UL-94-HBF, Mil-R-6130C, and FMVSS-302 flammability specifications.

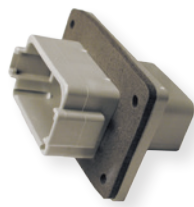

Gasket Part Number	Connector Part Number
DT3P-L012-GKT	DT04-3P-L012
DT4P-L012-GKT	DT04-4P-L012
DTP4P-L012-GKT	DTPO4-4P-L012
DT8P-L012-GKT	DT04-08P*-L012
DT12-L012-GKT	DT04-12P*-L012 DTM04-12P*-L012

DUST CAPS



The DT series dust caps are made of either thermoplastic or durable plastisol and are designed to provide protection for the connector interface when the two halves are not mated. The plastisol caps, available for plugs and receptacles, are suitable for providing temporary protection from dirt, dust, and paint overspray. The thermoplastic caps provide an environmental seal for an unmated plug.



Thermoplastic Dust Cap Part Number	Connector Part Number
1011-344-0205	DT06-2S
1011-345-0305	DT06-3S
1011-346-0405	DT06-4S
1011-347-0605	DT06-6S
1011-348-0805	DT06-08S*
1011-349-1205	DT06-12S*, DT16-15S*, DT16-18S*

DT Family



Plastisol Dust Cap Part Number	Connector Part Number
DTM3S-DC	DTM06-3S
DT3P-DC	DT04-3P
DT4P-DC	DT04-4P
DT6P-DC	DT04-6P
DTM12P-DC	DTM04-12P*
DT12P-DC, DT12P-DC-BK	DT04-12P*
DT12S-DC	DT06-12S*

BOOTS



Boots provide a professional looking finishing touch for DEUTSCH DT family connectors. Made of durable plastisol, these slip-on boots are not only aesthetically appealing, but also provide increased protection from dirt, paint overspray, and pressure washing. The plastisol boots are rated from -20°F to +212°F (-28°C to +100°C) and offer a slip-on design making installation quick and easy.



Receptacle Boot Description	Boot Part Number		
	DT Series	DTM Series	DTP Series
2 way receptacle boot, gray	DT2P-BT	DTM2P-BT	DTP2P-BT
2 way receptacle boot, black	DT2P-BT-BK	DTM2P-BT-BK	DTP2P-BT-BK
3 way receptacle boot, gray	DT3P-BT	DTM3P-BT	-
3 way receptacle boot, black	DT3P-BT-BK	DTM3P-BT-BK	-
4 way receptacle boot, gray	DT4P-BT	DTM4P-BT	DTP4P-BT
4 way receptacle boot, gray, enhanced length	-	-	DTP4P-BT-EN
6 way receptacle boot, gray	DT6P-BT	DTM6P-BT	-
6 way receptacle boot, black	DT6P-BT-BK	-	-
8 way receptacle boot, gray	DT8P-BT	DTM8P-BT	-
8 way receptacle boot, black	DT8P-BT-BK	DTM8P-BT-BK	-
12 way receptacle boot, gray	DT12P-BT	DTM12P-BT	-
12 way receptacle boot, black	DT12P-BT-BK	DTM12P-BT-BK	-
12 way receptacle boot, gray, enhanced length	DT12P-BT-EN	-	-

*Distorting the boots can lessen their longevity



Plug Boot Description	Boot Part Number		
	DT Series	DTM Series	DTP Series
2 way plug boot, gray	DT2S-BT	DTM2S-BT	DTP2S-BT
2 way plug boot, black	DT2S-BT-BK	DTM2S-BT-BK	-
3 way plug boot, gray	DT3S-BT	DTM3S-BT	-
3 way plug boot, black	DT3S-BT-BK	DTM3S-BT-BK	-
4 way plug boot, gray	DT4S-BT	DTM4S-BT	DTP4S-BT
4 way plug boot, gray, enhanced length	-	-	DTP4S-BT-EN
6 way plug boot, gray	DT6S-BT	DTM6S-BT	-
6 way plug boot, black	DT6S-BT-BK	-	-
8 way plug boot, gray	DT8S-BT	DTM8S-BT	-
8 way plug boot, black	DT8S-BT-BK	DTM8S-BT-BK	-
12 way plug boot, gray	DT12S-BT	DTM12S-BT	-
12 way plug boot, black	DT12S-BT-BK	DTM12S-BT-BK	-
12 way plug boot, gray, enhanced length	DT12S-BT-EN	-	-
48 way plug boot, gray	DT48S-BT	-	-

*Distorting the boots can lessen their longevity

BACKSHELLS

The DEUTSCH DT and DTM series backshells are designed to snap onto and mate with all standard (basic plug and receptacles without modifications that affect the rear of the connector) DT and DTM series connectors. The rigid, durable backshells offer a high level of protection and allow convoluted tubing to nest within the rear of the backshell. Straight (180°) and right angle (90°) versions and backshells with strain relief for jacketed cable are also available.



Since the backshells are designed to work with the standard DT and DTM connectors, tests should be conducted for fit and function of a backshell being used on any part with a modification.

DT Series Receptacle Backshells

Connector	Style	Strain Relief	Tubing size (mm)	Part Number
DT04-2P	180°		6, 7.5, 8.5, and 10	1011-229-0205
	180°	X	6, 7.5, 8.5, and 10	1011-257-0205
	90°		6, 7.5, 8.5, and 10	1011-230-0205
	90°	X	6, 7.5, 8.5, and 10	1011-258-0205
DT04-3P	180°		6, 7.5, 8.5, and 10	1011-233-0305
	180°	X	6, 7.5, 8.5, and 10	1011-261-0305
	90°		6, 7.5, 8.5, and 10	1011-234-0305
	90°	X	6, 7.5, 8.5, and 10	1011-262-0305
DT04-4P	180°		6, 7.5, 8.5, and 10	1011-237-0405
	180°	X	6, 7.5, 8.5, and 10	1011-265-0405
	90°		6, 7.5, 8.5, and 10	1011-238-0405
	90°	X	6, 7.5, 8.5, and 10	1011-266-0405
DT04-6P	180°		8.5, 10, and 13	1011-241-0605
	180°	X	8.5, 10, and 13	1011-269-0605
	90°		8.5, 10, and 13	1011-242-0605
	90°	X	8.5, 10, and 13	1011-270-0605
DT04-08P*	180°		8.5, 10, and 13	1011-245-0805
	90°		8.5, 10, and 13	1011-246-0805
DT04-12P*	180°		10, 13, and 17	1011-249-1205
	90°		10, 13, and 17	1011-250-1205



DT Series Plug Backshells



Connector	Style	Strain Relief	Tubing size (mm)	Part Number
DT06-2S	180°		6, 7.5, 8.5, and 10	1011-227-0205
	180°	X	6, 7.5, 8.5, and 10	1011-255-0205
	90°		6, 7.5, 8.5, and 10	1011-228-0205
	90°	X	6, 7.5, 8.5, and 10	1011-256-0205
DT06-3S	180°		6, 7.5, 8.5, and 10	1011-231-0305
	180°	X	6, 7.5, 8.5, and 10	1011-259-0305
	90°		6, 7.5, 8.5, and 10	1011-232-0305
	90°	X	6, 7.5, 8.5, and 10	1011-260-0305
DT06-4S	180°		6, 7.5, 8.5, and 10	1011-235-0405
	180°	X	6, 7.5, 8.5, and 10	1011-263-0405
	90°		6, 7.5, 8.5, and 10	1011-236-0405
	90°	X	6, 7.5, 8.5, and 10	1011-264-0405
DT06-6S	180°		8.5, 10, and 13	1011-239-0605
	180°	X	8.5, 10, and 13	1011-267-0605
	90°		8.5, 10, and 13	1011-240-0605
	90°	X	8.5, 10, and 13	1011-268-0605
DT06-08S*	180°		8.5, 10, and 13	1011-243-0805
	90°		8.5, 10, and 13	1011-244-0805
DT06-12S*	180°		10, 13, and 17	1011-247-1205
	90°		10, 13, and 17	1011-248-1205
DT06-12S*-****	180°		13 and 17	1028-043-1205

Note: 1028-043-1205 backshell is designed to fit on 12 way plugs with modifications

PULL OFF STRENGTH

Connector	F_p [N]	F_T [N]
DT04-2P / DT06-2S	50 / 50	50 / 10
DT04-3P / DT06-3S	50 / 50	50 / 50
DT04-4P / DT06-4S	50 / 50	50 / 25
DT04-6P / DT06-6S	50 / 50	50 / 30
DT04-08P* / DT06-08S*	50 / 50	50 / 35
DT04-12P* / DT06-12S*	50 / 50	50 / 40



DTM Series Backshells



Connector	Style	Tubing size (mm)	Part Number
DTM*04-2P	180°	7.5 and 8.5	1028-021-0205
DTM06-2S	180°	7.5 and 8.5	1011-273-0205
DTM*06-2S	180°	8.5	1028-041-0205
DTM*04-3P	180°	8.5	1028-024-0305
DTM*06-3S	180°	8.5	1028-005-0305
DTM*04-4P	180°	8.5	1028-027-0405
DTM*06-4S	180°	8.5	1028-008-0405
DTM06-6S	180°	10 and 13	1028-011-0605
DTM06-08S*	180°	10 and 13	1028-013-0805
DTM04-12P*	180°	13 and 17	1028-034-1205
DTM06-12S*	180°	13 and 17	1028-015-1205
Adapter for 2, 3, and 4 pin	90°	7.5 and 8.5	1028-016-0005
Adapter for 6 and 8 pin	90°	10 and 13	1028-017-0005

DT Family

MOUNTING CLIPS

Mounting clips are installed on the receptacle to mount DT series connectors. To meet design needs, the clips are available for several configurations and in plastic, stainless steel, or steel with zinc plating.

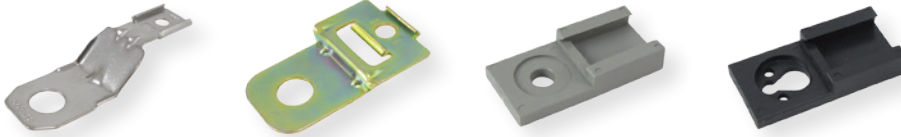

Part Number	Cavity Arrangement	Mounting Direction	Color/Material	Hole O.D. inches (mm)
1027-003-1200	DT 2, 3, 4, 6, 12 DTM, DTP (all)	Straight	Stainless steel	.433 (11.0)
1027-005-1200	DT 2, 3, 4, 6, 12 DTM, DTP (all)	Straight	Stainless steel	.512 (13.0)
1027-004-1200	DT 2, 3, 4, 6, 12 DTM, DTP (all)	Straight	Steel w/ zinc plating	.512 (13.0)
1027-008-1200	DT 2, 3, 4, 6, 12 DTM, DTP (all)	Side	Steel w/ zinc plating	.433 (11.0)
1027-013-1200/ 1027-017-1200	DT 2, 3, 4, 6, 12 DTM, DTP (all)	Side	Steel w/ zinc plating	.323 (8.2)
1027-001-0800	DT 8 cavity only	Straight	Stainless steel	.433 (11.0)
1027-006-0800	DT 8 cavity only	Straight	Stainless steel	.512 (13.0)
1027-002-0800	DT 8 cavity only	Straight	Steel w/ zinc plating	.512 (13.0)
1027-014-0800	DT 8 cavity only	Straight	Steel w/ zinc plating	.323 (8.2)
1011-026-0205	DT 2, 3, 4, 6, 12 DTM, DTP (all)	Straight	Gray plastic	.200 (5.08)
1011-030-0205	DT 2, 3, 4, 6, 12 DTM, DTP (all)	Straight	Black plastic	---
1011-310-0205* *Connector removeable with 50N of force	DT 2, 3, 4, 6, 12 DTM, DTP (all)	Straight	Black plastic	---
1011-027-0805	DT 8 cavity only	Straight	Gray plastic	.200 (5.08)

DT Family

DT Family Printed Circuit Board Connectors

The DT Family offers printed circuit board (PCB) connectors that are heavy duty environmentally sealed connectors designed for wire-to-circuit board connections. Available in a variety of styles for the DT, DTM, and DTP connector series, DEUTSCH PCB connectors cover a range of pin counts from 2 to 48 and wire gauges from 10 to 22. Many of the connectors are available in straight or 90° pin options.

PCB PART NUMBERING SYSTEM

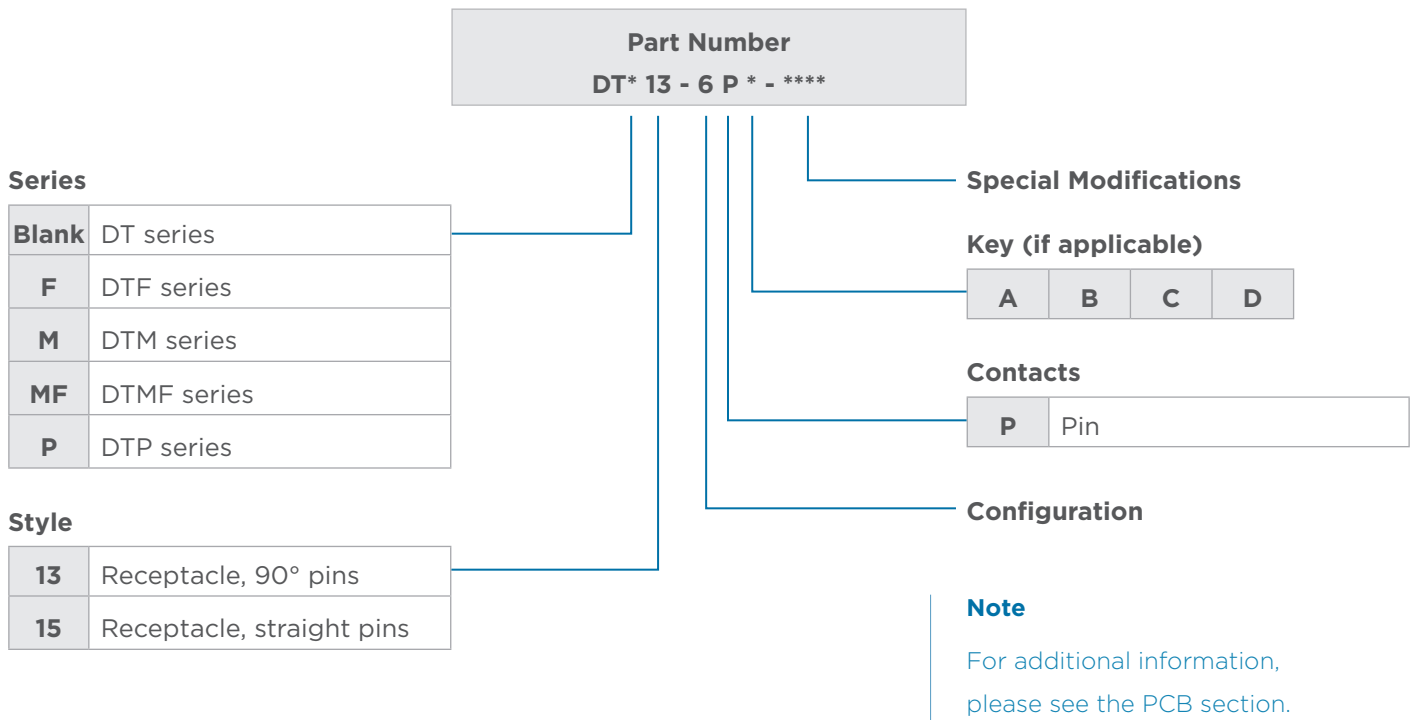

DT FAMILY PCB CONFIGURATIONS

Connector Description	Pin/Flange Style			
	90° Flange	Straight Flange	90° Flangeless	Straight Flangeless
2 way receptacle, DT series	DT13-2P	DT15-2P	DTF13-2P	-
3 way receptacle, DT series	-	-	DTF13-3P	-
4 way receptacle, DT series	DT13-4P	DT15-4P	DTF13-4P	-
4 way receptacle, DTP series	DTP13-4P	DTP15-4P	-	-
6 way receptacle, DT series	DT13-6P	DT15-6P	DTF13-6P	-
8 way receptacle, DT series	DT13-08P*	DT15-08P*	-	-
12 way receptacle, DT series	DT13-12P*	DT15-12P*	DTF13-12P*	DTF15-12P*
12 way receptacle, DTM series	DTM13-12P*	DTM15-12P*	-	-
48 way receptacle, DTM series	-	-	-	DTMF15-48P

* = Keying (A, B, C, or D)

DT Family

DTMH Series & High Temperature Modification Overview

The DTMH series and DTM series EE04 modification connectors are environmentally sealed, high temperature connectors capable of operating in temperatures -55°C to +150°C. They accept size 20 contacts and carry 7.5 amps each. The DTMH connectors are available in 2-4 cavity arrangements and feature an integrated TPA for easy assembly. The EE04 connectors are available in 6, 8, and 12 cavity arrangements and require a secondary wedgelock.



DTMH SERIES PART NUMBERING SYSTEM

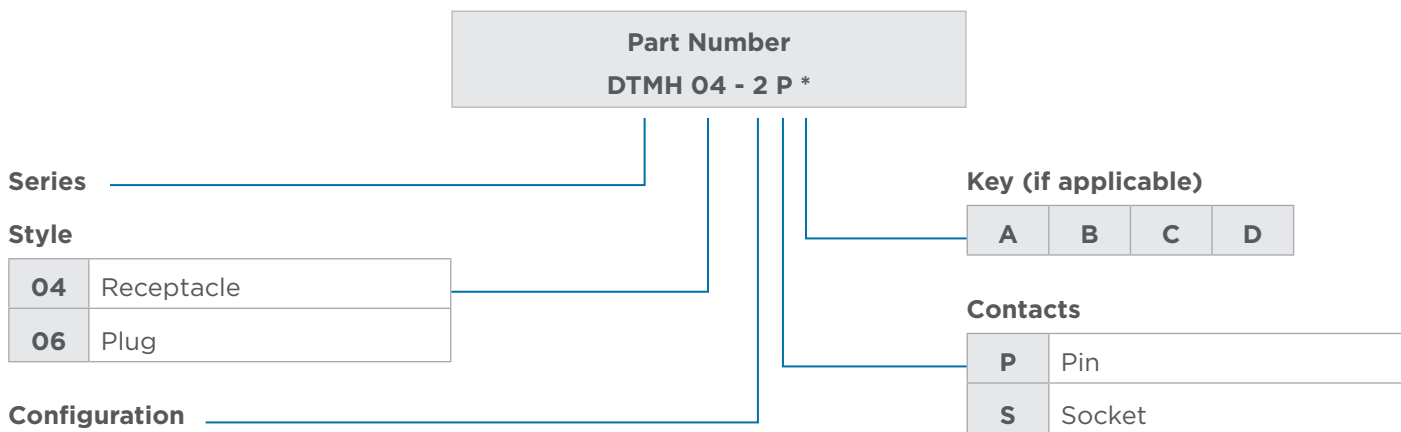

DTMH SERIES CONFIGURATIONS



DTMH0*-2**
2 size 20



DTMH0*-3**
3 size 20



DTMH0*-4**
4 size 20

DTMH SERIES DIMENSIONS



DTMH Plug

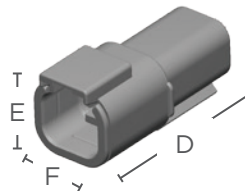

DTMH Receptacle

Cavity	Overall Length A	Overall Height B	Overall Width C	Overall Length D	Overall Height E	Overall Width F
2	1.085 (27.56)	.508 (12.90)	.555 (14.10)	1.620 (41.15)	.638 (16.21)	.729 (18.52)
3	1.085 (27.56)	.558 (14.17)	.640 (16.26)	1.620 (41.16)	.638 (16.21)	.894 (22.71)
4	1.185 (30.10)	.652 (16.56)	.680 (17.27)	1.720 (43.69)	.772 (19.61)	.834 (21.18)

Dimensions are for reference only.

DTM SERIES (EE04 MOD) PART NUMBERING SYSTEM

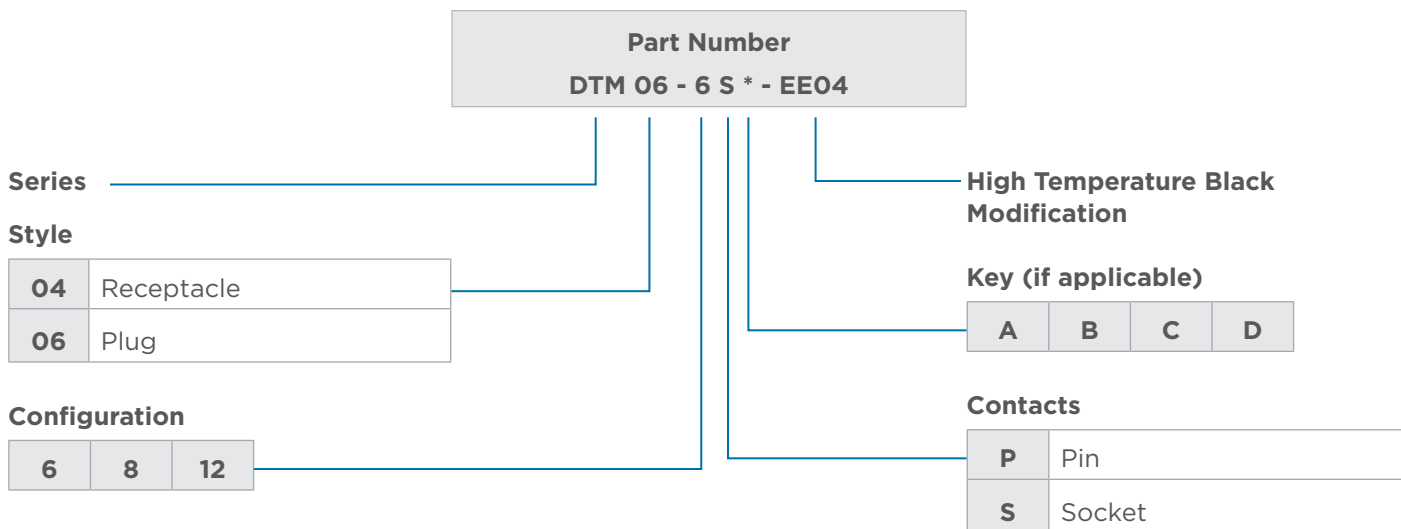

DTM SERIES CONFIGURATIONS

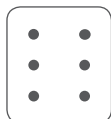

DTM0*-6*-EE04
6 size 20



DTM0*-08-EE04**
8 size 20
A, B, C, D



DTM0*-12-EE04**
12 size 20
A, B, C, D

Note

DTM EE04 connectors require a secondary wedgelock that is sold separately.

DTM SERIES DIMENSIONS

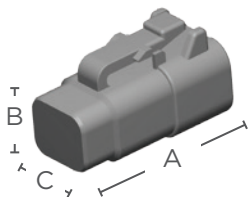

DTM Plug

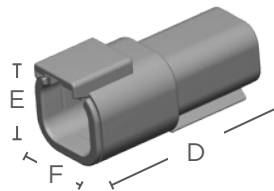

DTM Receptacle

Cavity	Overall Length	Overall Height	Overall Width	Overall Length	Overall Height	Overall Width
	A	B	C	D	E	F
6	1.185 (30.10)	.817 (20.75)	.600 (15.24)	1.720 (43.69)	.937 (23.80)	.756 (19.20)
8	1.185 (30.10)	.600 (15.24)	1.245 (31.62)	1.720 (43.69)	.792 (20.12)	1.245 (31.62)
12	1.185 (30.10)	.600 (15.24)	1.575 (40.01)	1.720 (43.69)	.796 (20.22)	1.575 (40.01)

Dimensions are for reference only.

DT Family

DTV Series Overview

The DEUTSCH DTV series connectors offer the same time tested reliability and performance as the DT series, with the added flexibility of an 18 cavity flanged design.

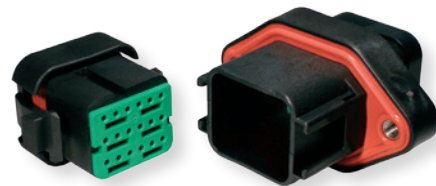

DTV SERIES PART NUMBERING SYSTEM

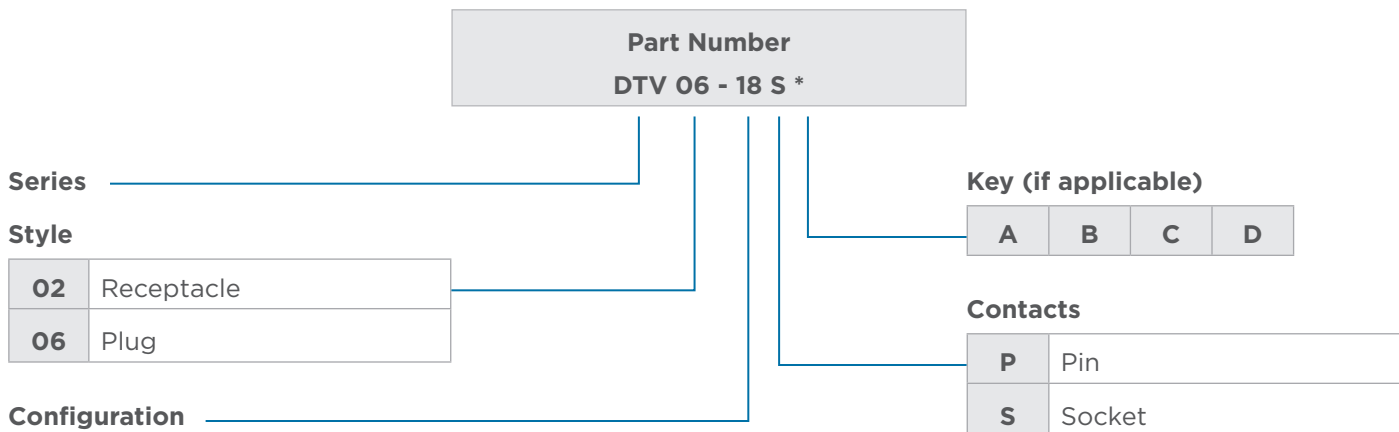

DTV SERIES DIMENSIONS

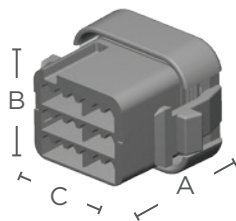

DTV Plug

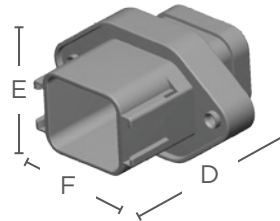

DTV Receptacle

Cavity	Overall Length A	Overall Height B	Overall Width C	Overall Length D	Overall Height E	Overall Width F
18	1.405 (35.69)	1.059 (26.90)	1.450 (36.83)	2.495 (63.37)	1.786 (45.36)	3.194 (81.12)

Dimensions are for reference only.

SECONDARY WEDGELOCKS



DTV Series Receptacle Wedglock

WV-18P	Wedglock for 18 way receptacle
--------	--------------------------------



DTV Series Plug Wedglock

WV-18S	Wedglock for 18 way plug
--------	--------------------------

How To Instructions

CONTACT INSERTION

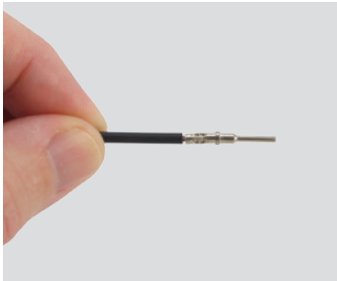

Step 1:
Grasp crimped contact approximately one inch behind the contact barrel.



Step 2:
Hold connector with rear grommet facing you.

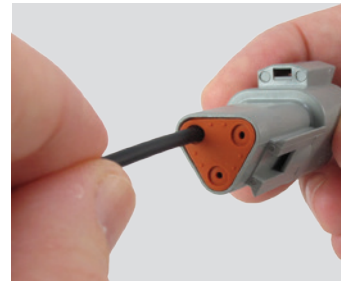

Step 3:
Push contact straight into connector grommet until a click is felt. A slight tug will confirm that it is properly locked in place.

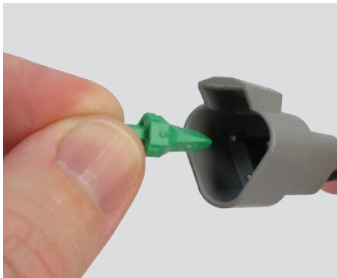

Step 4:
Once all contacts are in place, insert green wedge. The green wedge will snap into place.

Note

The receptacle is shown, use the same procedure for the plug.

CONTACT REMOVAL

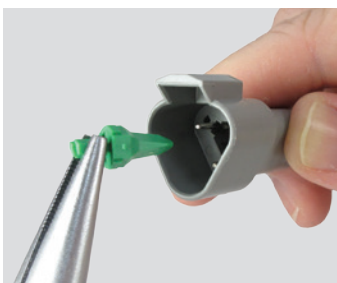

Step 1:
Remove green wedge using needle-nose pliers to pull wedge straight out.



Step 2:
To remove the contacts, gently pull wire backwards, while at the same time releasing the locking finger by moving it away from the contact with a screwdriver.



Step 3:
Hold the rear seal in place, as removing the contact will displace the seal.

Contents

HD10 Series Overview	134
Performance Specifications	134
Material Specifications	134
Dimensions	135
Configurations	136
Ordering Information	137
Special Modifications	138
Accessories	139-142
How To Instructions	143

HD10 Series

HD10 Series Overview

The HD10 series is an environmentally sealed, thermoplastic, and cylindrical connector series. With arrangements from 3 to 9 cavities, HD10 connectors accept size 4, 12, or 16 contacts and are available either in-line or flanged. HD10 connectors are heavily used for diagnostic applications and are available with or without a coupling ring.



DEUTSCH CONNECTOR PERFORMANCE SPECIFICATIONS

Temperature:	Operating at temperatures -55°C to +125°C
Durability:	No electrical or mechanical defects after 100 cycles of engagement and disengagement.
Vibration:	No unlocking or unmating and exhibits no mechanical or physical damage after sinusoidal vibration levels of 20 G's at 10 to 2000 Hz in each of the three mutually perpendicular planes. No electrical discontinuities longer than 1 microsecond.
Fluid Resistance:	Connectors show no damage when exposed to most fluids used in industrial applications.
Insulation Resistance:	1000 megohms minimum at 25°C.
Immersion:	IP68 rating
Moisture Resistance:	Properly wired and mated connections will withstand immersion under three feet of water without loss of electronic qualities or leakage.
Dielectric Withstanding Voltage:	Current leakage less than 2 milliamps at 1500 volts AC.
Thermal Cycle:	No cracking, chipping or leaking after 20 test cycles from -55°C to +125°C.

MATERIAL SPECIFICATIONS

Grommet:	Silicone rubber
Insert Retainer:	Thermoplastic
Receptacle	
Interfacial Seal:	Silicone rubber
Shell:	Thermoplastic



HD10 Series

DIMENSIONS

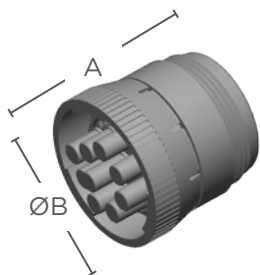

HD10 Plug

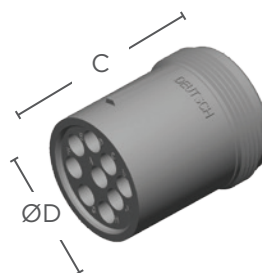

HD10 Receptacle

Cavity	Overall Length A	Overall Height ØB	Overall Length C	Overall Height ØD
3	1.609 (40.87)	1.069 (27.15)	1.639 (41.63)	.851 (21.62)
4	1.639 (41.63)	1.595 (40.51)	1.639 (41.63)	1.281 (32.54)
5	1.609 (40.87)	1.218 (30.94)	1.639 (41.63)	1.001 (25.43)
6	1.619 (41.12)	1.453 (36.91)	1.639 (41.63)	1.141 (28.98)
9	1.609 (40.87)	1.593 (40.47)	1.639 (41.63)	1.281 (32.54)

Dimensions are for reference only.

CONNECTOR STYLES

Plug
HD16

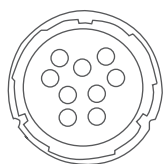

Square Flange
Receptacle
HD10

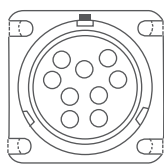

In-line
Receptacle
HD14

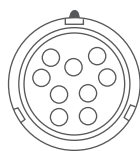

CONFIGURATIONS

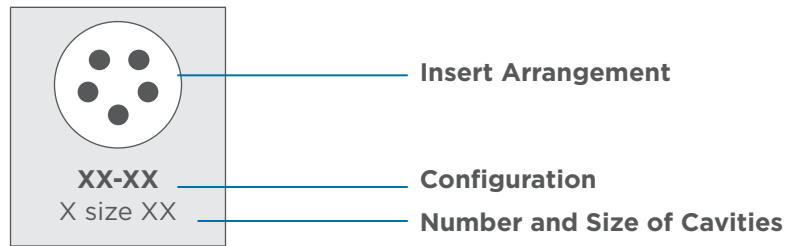

3-16/3-96*
3 size 16



4-4
1 size 4
3 size 16

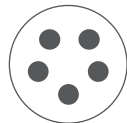

5-16
5 size 16

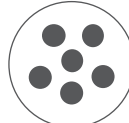

6-12
6 size 12

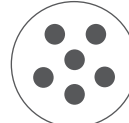

6-96
6 size 16



9-16
9 size 16



9-96*
9 size 16

*Also available in an "E" seal

PART NUMBERING SYSTEM

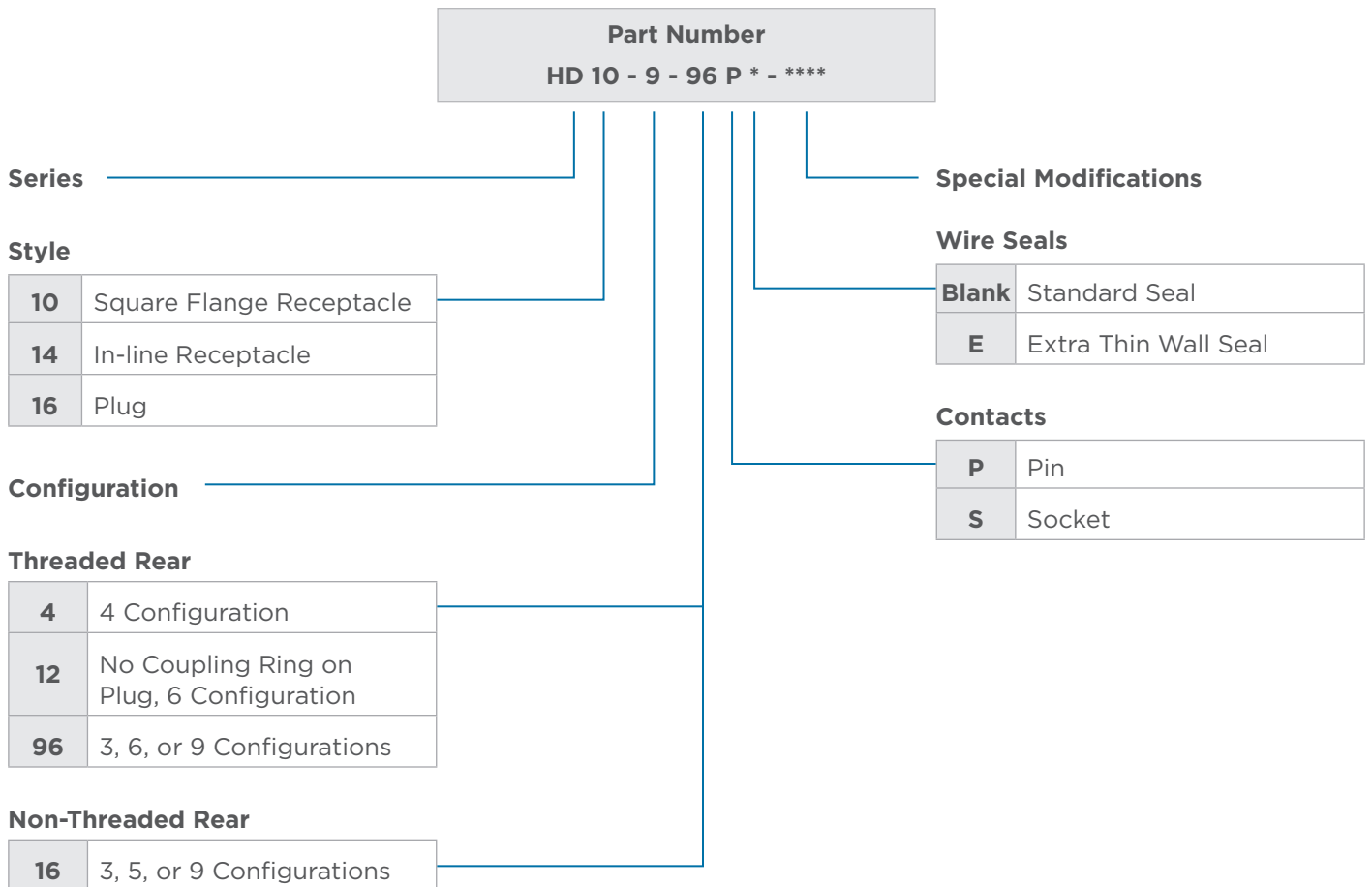

HD10 Series

ORDERING INFORMATION

Here are some of the common part numbers in the HD10 series. Several additional connectors may be available.

Position	Contact Size	Rear Threads	Plug	Receptacle Inline	Receptacle Flange
3	16	no	HD16-3-16S	HD14-3-16P	-
		yes	HD16-3-96S	HD14-3-96P	HD10-3-96P
4	4/16	yes	HD16-4-4S	-	HD10-4-4P
5	16	no	HD16-5-16S	HD14-5-16P	HD10-5-16P
6	16	yes	HD16-6-96S	HD14-6-96P	HD10-6-96P
6	12	yes	HD16-6-12S-B010	HD14-6-12P	HD10-6-12P
9	16	no	HD16-9-16S	HD14-9-16P	HD10-9-16P
		yes	HD16-9-96S	HD14-9-96P	HD10-9-96P
9 (1939)	16	yes	HD16-9-1939S	HD14-9-1939P	HD10-9-1939P

WIRE SEALING RANGE

The wire sealing range is the recommended outside diameter of the wire insulation required to maintain an environmental seal in the rear connector cavities.

Contact Size	Standard Seal	Extra Thin Seal E-Seal
16 14-20 AWG (2.0-0.5mm ²)	.100-.150 (2.54-3.81)	.053-.120 (1.35-3.05)
12 10-14 AWG (5.0-2.0mm ²)	.134-.170 (3.40-4.32)	-
4 6 AWG (13.0mm ²)	.280-.292 (7.11-7.42)	-

Special Modifications

HD10 series connectors offer several modifications to enhance the design flexibility and meet application specific needs. Options include the addition of a coupling ring and connector body color, just to mention a few. By combining the HD10 series connectors with the available modifications and accessories, the design possibilities are increased.



B010 MODIFICATION

The B010 modification provides the addition of a coupling ring used for mating. The B010 modification is only available on the HD16-6-12S-B010 connector.



E004 MODIFICATION

The E004 modification changes the HD10 series connector from the standard gray to a black connector body.



J1939 MODIFICATIONS (BP03, P080)

The P080 modification changes the HD10 series connector body color from the standard gray to green and meets the J1939 Type II requirements. The BP03 modification is similar to the P080 modification, but features a panel mount.



N005 MODIFICATION

The N005 modification is an HD10 series receptacle with molded-in, straight PCB pins.

HD10 Series

Accessories

Several accessory items are available to complement HD10 series connectors including boots, backshells, gaskets, and protective caps. Accessory items cover a wide array of design requirements such as assisting with mounting, providing additional protection, and offering enhanced aesthetics.

BACKSHELLS



DEUTSCH HD10 series backshells are designed to screw onto all threaded HD10 connectors. Rated for temperatures from -40°C to +134°C, the rigid, durable backshells offer a high level of protection, provide strain relief, and improve aesthetics.



Connector Part Number	Cable Diameter	Backshell Part Number	Compression Nut Part Number
HD1*-3-96*	.187-.300	M902-2131	M902-2041
	.300-.430	M902-2132	M902-2042
HD1*-6-96*/HD1*-6-12*	.187-.300	M902-2161	M902-2041
	.300-.430	M902-2162	M902-2042
	.430-.570	M902-2163	M902-2053
	.570-.710	M902-2164	M902-2054
HD1*-9-96*/HD1*-9-1939**	.187-.300	M902-2191	M902-2041
	.300-.430	M902-2192	M902-2042
	.430-.570	M902-2193	M902-2053
	.570-.710	M902-2194	M902-2054

Backshell Technical Specifications:
 Material - PC/PET Polyester Blend, UV-Stabilized, Flame Retardant, Black
 Flammability - UL94-VO rated material, Weatherability - UL746C

HD10 Series

STRAIN RELIEF

DEUTSCH HD10 series strain reliefs are designed to screw onto threaded 3, 4, 6, and 9 cavity HD10 connectors. The rigid, durable strain reliefs offer a high level of protection, provide tie wrap holders to reduce strain from the wires, and improve aesthetics.



Part Number	Description
HD18-003	3 cavity strain relief
HD18-006	6 cavity strain relief
HD18-009	4 or 9 cavity strain relief

helpful hint

Attaching the connector to a structure eliminates straining the electrical system in service.



BOOTS



Boots provide a professional looking finishing touch for DEUTSCH HD10 series connectors. Made of durable plastisol, these slip-on boots are not only aesthetically appealing, but also provide increased protection from dirt, paint overspray, and pressure washing. The plastisol boots are rated from -20°F to +212°F (-28°C to +100°C) and offer a slip-on design making installation quick and easy.



Part Number	Description
HD10-3BT	3 cavity boot, gray
HD10-5BT	5 cavity boot, gray
HD10-5BT-BK	5 cavity boot, black
HD10-6BT	6 cavity boot, gray
HD10-6BT-BK	6 cavity boot, black
HD10-9BT	9 cavity boot, gray
HD10-9BT-BK	9 cavity boot, black

*Distorting the boots can lessen their longevity

HD10 Series

GASKETS



Moisture, dirt, salt, sand, and road debris can all work their way into electrical panels through unsealed mounting flanges. Rated to operate in environments from -70°F to +225°F (-56°C to +107°C), these rugged high quality neoprene gaskets form a tight seal between the panel face and connector flange to help keep out destructive elements. The gaskets have a thickness of .125" and the material meets the UL-94-HBF, Mil-R-6130C, and FMVSS-302 flammability specifications.



Gasket Part Number	Connector Part Number
HD10-3-GKT	HD10-3-****
HD10-5-GKT	HD10-5-****
HD10-6-GKT	HD10-6-****
HD10-9-GKT	HD10-9-****

PROTECTIVE DUST CAPS

HD10 series protective dust caps provide an environmental seal and are used to protect the connector interface when the connector is not mated.



Part Number	Description
HDC14-3	3 cavity plug protective cap
HDC14-6	6 cavity plug protective cap
HDC14-9	9 cavity plug protective cap
HDC16-3	3 cavity receptacle protective cap
HDC16-5	5 cavity receptacle protective cap
HDC16-6	6 cavity receptacle protective cap
HDC16-6-E004	6 cavity receptacle protective cap, black
HDC16-9	9 cavity receptacle protective cap
HDC16-9-E004	9 cavity receptacle protective cap, black

LANYARDS





Lanyards are available in nitrile or nylon coated steel and designed for use with protective dust caps.



HDC9-JDL082397
(DEUTSCH HDC16-9-E004 dust cap assembled with JDL082397)



HDC16-9-L47N
(DEUTSCH HDC16-9 dust cap assembled with L47N-600-1)

Lanyard	Material	Material Diameter	Length	Min. Breaking Strength
 JDL082397	Nitrile o-ring, 3M heat shrink with thermoplastic adhesive	.07 inches	5.31 inches	---
 L47N-600-1	7 x 7 galvanized steel cable coated with clear nylon	.047 inches	6 inches	270 lbs.

Dimensions are for reference only.

Dust Cap/Lanyard Assembly Part Number*	Used On	Connector Cavities	Lanyard Material	Dust Cap Color
HDC14-3-JDL	Plug	3	Nitrile	Gray
HDC14-6-JDL	Plug	6	Nitrile	Gray
HDC14-6-LA	Plug	6	Steel	Gray
HDC14-9-JDL	Plug	9	Nitrile	Gray
HDC16-3-JDL	Receptacle	3	Nitrile	Gray
HDC16-3-LA	Receptacle	3	Steel	Gray
HDC16-5-LA	Receptacle	5	Steel	Gray
HDC16-6-JDL	Receptacle	6	Nitrile	Gray
HDC16-6-LA	Receptacle	6	Steel	Gray
HDC16-9-JDL	Receptacle	9	Nitrile	Gray
HDC9-JDL082397	Receptacle	9	Nitrile	Black
HDC16-9-L47N	Receptacle	9	Steel	Gray
HDC16-9-E004-L47N	Receptacle	9	Steel	Black

*Other dust cap/lanyard assemblies may be available

How To Instructions

CONTACT INSERTION

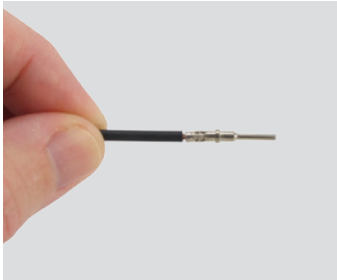

Step 1:
Grasp crimped contact approximately one inch behind the contact barrel.



Step 2:
Hold connector with rear grommet facing you.

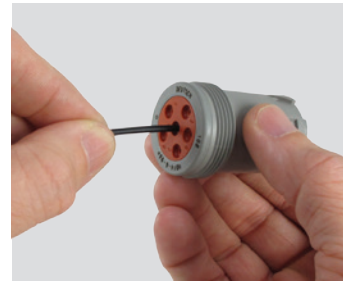

Step 3:
Push contact straight into connector grommet until a click is felt. A slight tug will confirm that it is properly locked in place.

CONTACT REMOVAL

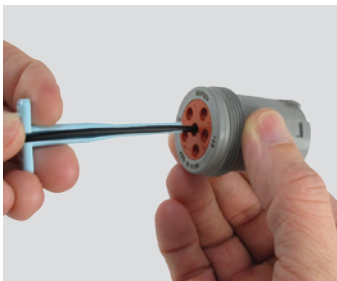

Step 1:
With rear insert toward you, snap appropriate size removal tool over the wire of contact to be removed.

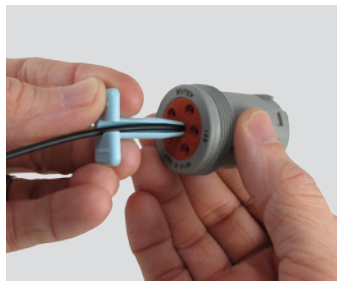

Step 2:
Slide tool along the wire into the insert cavity until it engages contact and resistance is felt.

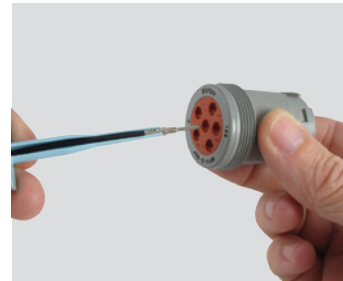

Step 3:
Pull contact wire assembly out of connector.

HD10 Series

NOTES:

Contents

HD30 & HDP20 Series Overview	145
Performance Specifications	146
Material Specifications	147
Dimensions	147
Configurations	148-149
Ordering Information	150-151
Special Modifications	153-154
Accessories	154-158
Mounting	158-159
How To Instructions	159-160

HD30 & HDP20 Series

HD30 & HDP20 Series Overview

Designed specifically for the truck, bus, and off-highway industry, the HD30 & HDP20 series connectors are heavy duty, environmentally sealed, multi-pin circular connectors. Available in metal or thermoplastic housings, these connectors offer multiple pin configurations that accept contact sizes 4 through 20.

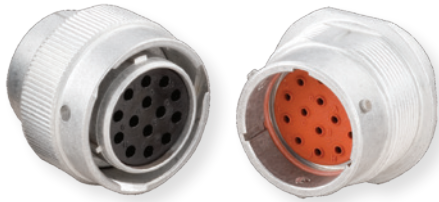

HD30 SERIES OVERVIEW

The DEUTSCH HD30 series connectors are constructed from a metal shell developed to meet the needs of the heavy duty equipment and transportation industries. The HD30 features include quick connect-disconnect bayonet coupling, single hole bulkhead mounting, silicone seals, and a rear insertion/rear removal contact system.



HDP20 SERIES OVERVIEW

The HDP20 series connectors are heavy duty rated, environmentally sealed, composite shell, multi-pin connectors. The composite thermoplastic shell is suited for applications where chemicals can damage a connector housing. HDP20 features quick connect-disconnect bayonet coupling, single hole bulkhead mounting, silicone seals, and a rear insertion/rear removal contact system.

DEUTSCH CONNECTOR PERFORMANCE SPECIFICATIONS

Temperature:	Operating at temperatures -55°C to +125°C
Durability:	No electrical or mechanical defects after 100 cycles of engagement and disengagement.
Vibration:	No unlocking or unmating and exhibits no mechanical or physical damage after sinusoidal vibration levels of 20 G's at 10 to 2000 Hz in each of the three mutually perpendicular planes. No electrical discontinuities longer than 1 microsecond.
Fluid Resistance:	Connectors show no damage when exposed to most fluids used in industrial applications.
Insulation Resistance:	1000 megohms minimum at 25°C.
Immersion:	IP68 rating
Moisture Resistance:	Properly wired and mated connections will withstand immersion under three feet of water without loss of electronic qualities or leakage.
Dielectric Withstanding Voltage:	Current leakage less than 2 milliamps at 1500 volts AC.
Thermal Cycle:	No cracking, chipping or leaking after 20 test cycles from -55°C to +125°C.

HD30 & HDP20 Series

MATERIAL SPECIFICATIONS

HD30 Series

Grommet: Silicone rubber

Insert Retainer: Unfilled PEI

Plug Coupling Ring: Aluminum

Shell: Aluminum

HDP20 Series

Grommet: Silicone rubber

Insert Retainer: Unfilled PEI

Plug Coupling Ring: Glass filled PA

Shell: Glass filled PA

DIMENSIONS

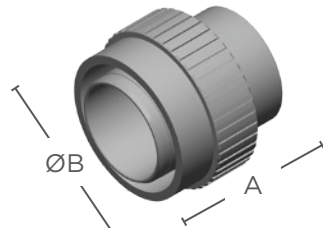

HD/HDP Plug

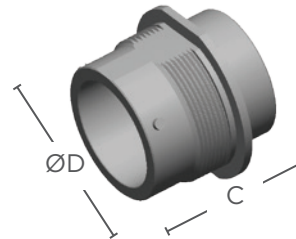

HD/HDP Receptacle

Shell Size	Overall Length A	Overall Height ØB	Overall Length C	Overall Height ØD
18	1.521 (38.63)	1.700 (43.17)	1.648 (41.86)	1.750 (44.45)
24	1.521 (38.63)	1.950 (49.53)	1.648 (41.86)	2.000 (50.80)

Dimensions are for reference only.

CONFIGURATIONS

Wire Seal Options

N	Normal wire seals (green ring)
T	Thin wall wire seals (gray ring)
E	Extra thin wall wire seals (blue ring)

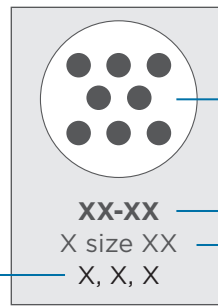

18 SHELL SIZE CONFIGURATIONS

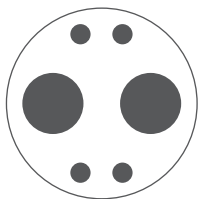

18-6
2 size 4 & 4 size 16
N, E

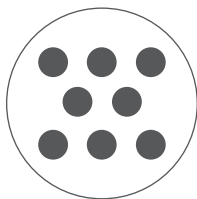

18-8
8 size 12
N, E

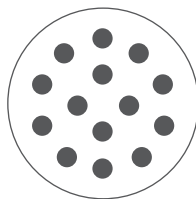

18-14
14 size 16
N, T, E

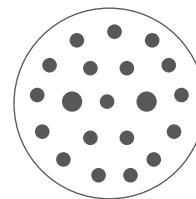

18-20
2 size 16 & 18 size 20
N, E

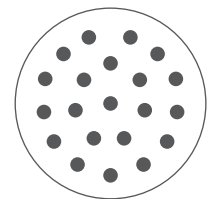

18-21
21 size 20
N

24 SHELL SIZE CONFIGURATIONS

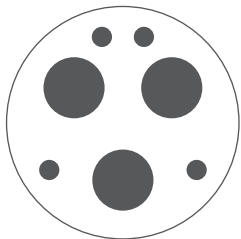

24-7(-C038 only)
3 size 4+ & 4 size 16
N

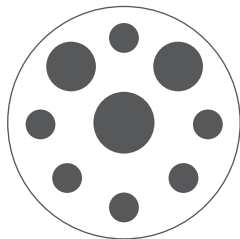

24-9
1 size 4, 2 size 8
& 6 size 12
N, E

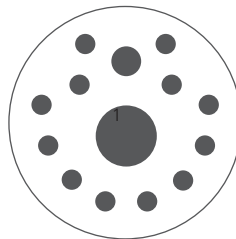

24-14
1 size 4, 1 size 12
& 12 size 16
N, E

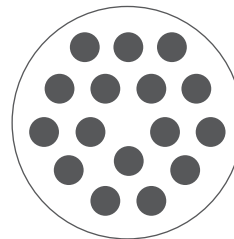

24-16
16 size 12
N, E

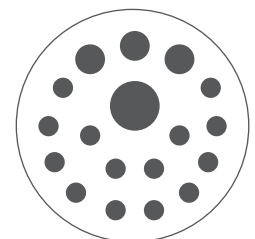

24-18
1 size 8, 3 size 12
& 14 size 16
N, E

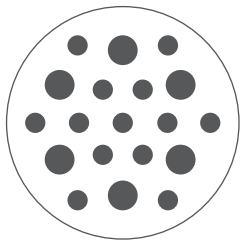

24-19
6 size 12
& 13 size 16
N, E

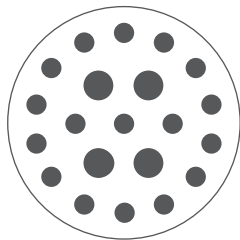

24-21
4 size 12
& 17 size 16
N, E

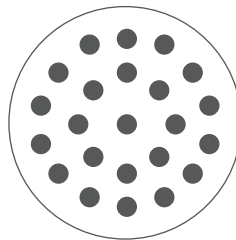

24-23
23 size 16
N, T, E

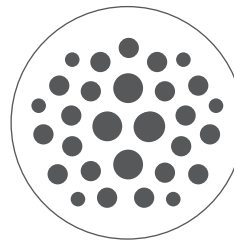

24-29
4 size 12, 19 size 16
& 6 size 20
E*

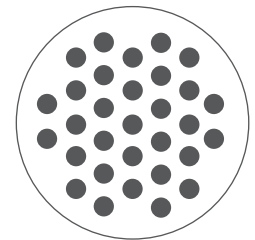

24-31
31 size 16
T*, E*

†Requires size 4 contact part numbers, 5960-203-04**(pin) and 5962-203-04**(socket) *Modified seal, see drawing.

HD30 & HDP20 Series

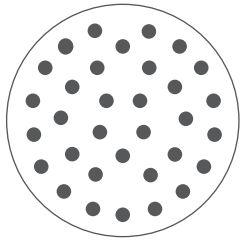

24-33
33 size 20
N

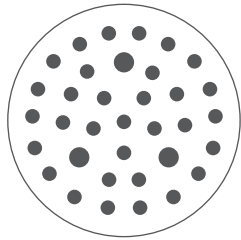

24-35
3 size 16 & 32 size 20
N, E

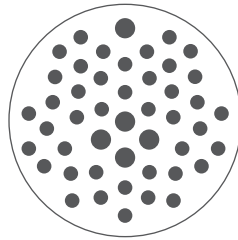

24-47
5 size 16 & 42 size 20
E*

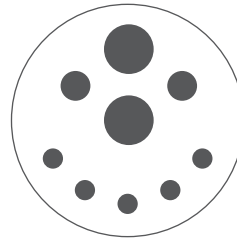

24-91-P064†
2 size 8, 2 size 12 & 5 size 16
N, E

*Modified seal, see drawing

†Without P064 modification, plug cavities 4 and 5 are internally connected

HD30 SERIES PART NUMBERING SYSTEM

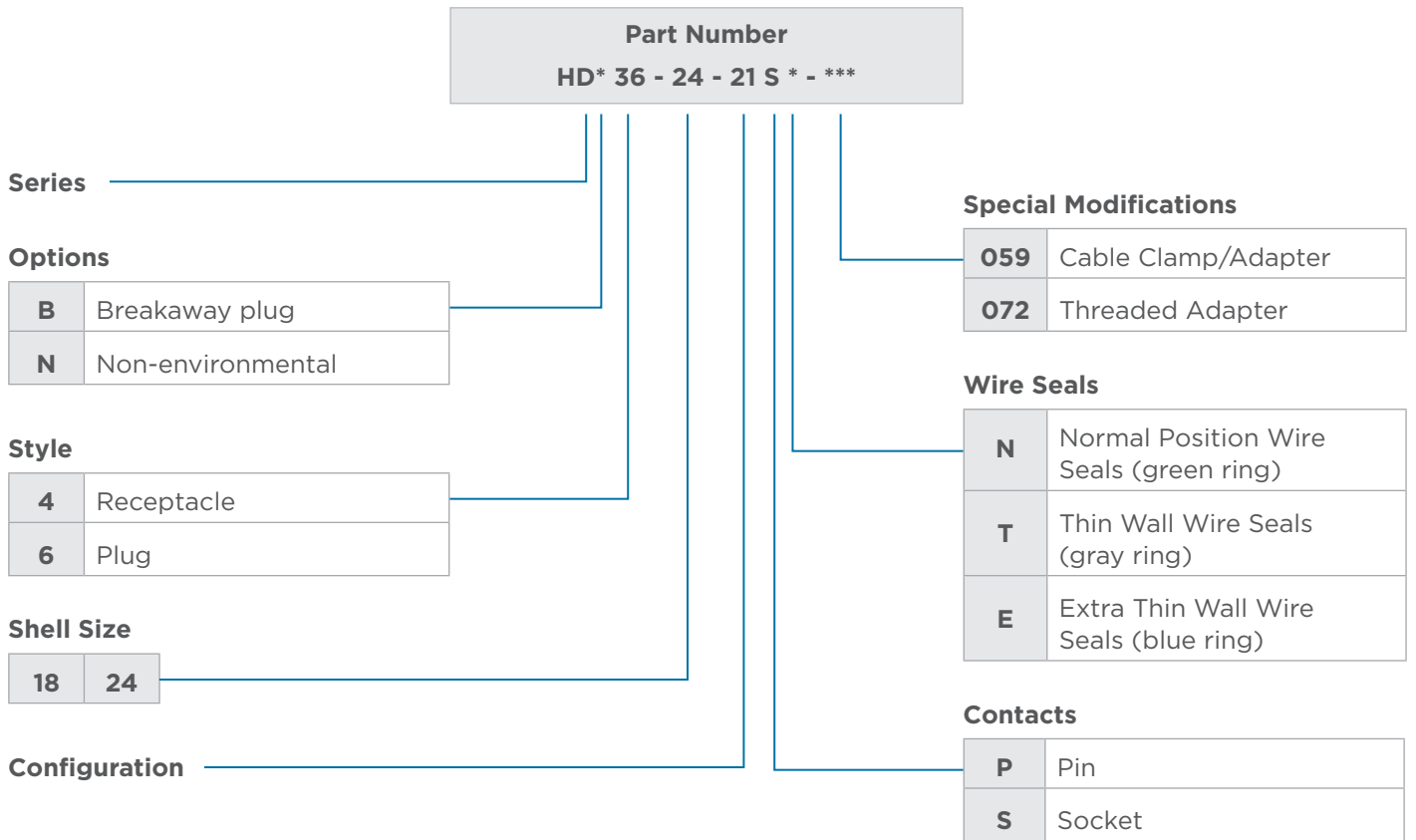

Note

Reverse arrangements are available as a keying option for the HD30 & HDP20 series connectors.

HD30 & HDP20 Series

HDP20 SERIES PART NUMBERING SYSTEM

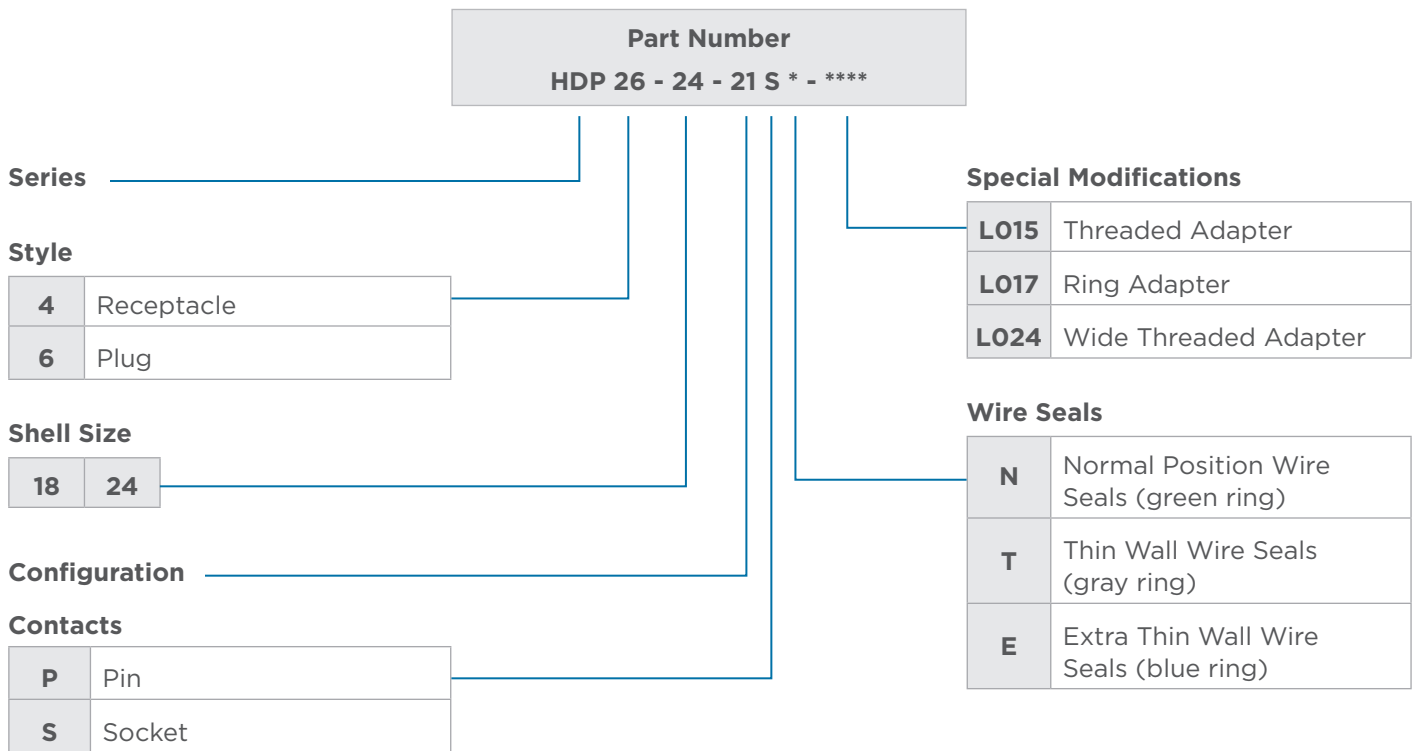

helpful hint

Making the socket contact side the “hot side” can reduce the danger of electric shock.

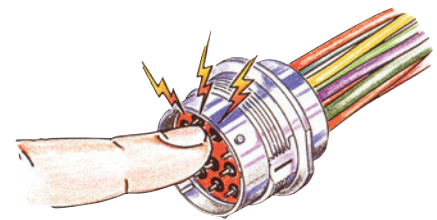
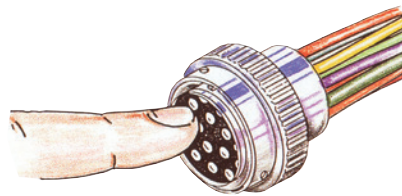

ORDERING INFORMATION

Here are some of the common part numbers in the HD30 & HDP20 series. Several additional connectors may be available.

Shell Sz- Position	Series	Plug Standard Dia. Seal	Receptacle Standard Dia. Seal	Plug Reduced Dia. Seal	Receptacle Reduced Dia. Seal
18-6	HDP20	HDP26-18-6SN	HDP24-18-6PN	HDP26-18-6SE	HDP24-18-6PE
	HD30	HD36-18-6SN	HD34-18-6PN	HD36-18-6SE	HD34-18-6PE
18-8	HDP20	HDP26-18-8SN	HDP24-18-8PN	HDP26-18-8SE	HDP24-18-8PE
	HD30	HD36-18-8SN	HD34-18-8PN	HD36-18-8SE	HD34-18-8PE
18-14	HDP20	HDP26-18-14SN	HDP24-18-14PN	HDP26-18-14SE	HDP24-18-14PE
	HD30	HD36-18-14SN	HD34-18-14PN	HD36-18-14SE	HD34-18-14PE
18-20	HDP20	HDP26-18-20SN	HDP24-18-20PN	HDP26-18-20SE	HDP24-18-20PE
	HD30	HD36-18-20SN	HD34-18-20PN	HD36-18-20SE	HD34-18-20PE

HD30 & HDP20 Series

ORDERING INFORMATION (CONTINUED)

Shell Sz- Position	Series	Plug Standard Dia. Seal	Receptacle Standard Dia. Seal	Plug Reduced Dia. Seal	Receptacle Reduced Dia. Seal
18-21	HDP20	HDP26-18-21SN	HDP24-18-21PN	HDP26-18-21SE	HDP24-18-21PE
	HD30	HD36-18-21SN	HD34-18-21PN	HD36-18-21SE	HD34-18-21PE
24-7	HDP20	HDP26-24-7SN	HDP24-24-7PN	HDP26-24-7SE	HDP24-24-7PE
	HD30	HD36-24-7SN	HD34-24-7PN	HD36-24-7SE	HD34-24-7PE
24-91- P064	HDP20	HDP26-24- 91SN-P064	HDP24-24- 91PN-P064	-	-
24-9	HDP20	HDP26-24-9SN	HDP24-24-9PN	HDP26-24-9SE	HDP24-24-9PE
	HD30	HD36-24-9SN	HD34-24-9PN	HD36-24-9SE	HD34-24-9PE
24-14	HDP20	HDP26-24-14SN	HDP24-24-14PN	HDP26-24-14SE	HDP24-24-14PE
	HD30	HD36-24-14SN	HD34-24-14PN	HD36-24-14SE	HD34-24-14PE
24-16	HDP20	HDP26-24-16SN	HDP24-24-16PN	HDP26-24-16SE	HDP24-24-16PE
	HD30	HD36-24-16SN	HD34-24-16PN	HD36-24-16SE	HD34-24-16PE
24-18	HDP20	HDP26-24-18SN	HDP24-24-18PN	HDP26-24-18SE	HDP24-24-18PE
	HD30	HD36-24-18SN	HD34-24-18PN	HD36-24-18SE	HD34-24-18PE
24-19	HDP20	HDP26-24-19SN	HDP24-24-19PN	HDP26-24-19SE	HDP24-24-19PE
	HD30	HD36-24-19SN	HD34-24-19PN	HD36-24-19SE	HD34-24-19PE
24-21	HDP20	HDP26-24-21SN	HDP24-24-21PN	HDP26-24-21SE	HDP24-24-21PE
	HD30	HD36-24-21SN	HD34-24-21PN	HD36-24-21SE	HD34-24-21PE
24-23	HDP20	HDP26-24-23SN	HDP24-24-23PN	HDP26-24-23SE	HDP24-24-23PE
	HD30	HD36-24-23SN	HD34-24-23PN	HD36-24-23SE	HD34-24-23PE
24-29	HDP20	HDP26-24-29SN	HDP24-24-29PN	HDP26-24-29SE	HDP24-24-29PE
	HD30	HD36-24-29SN	HD34-24-29PN	HD36-24-29SE	HD34-24-29PE
24-31	HDP20	HDP26-24-31SN	HDP24-24-31PN	HDP26-24-31SE	HDP24-24-31PE
	HD30	HD36-24-31SN	HD34-24-31PN	HD36-24-31SE	HD34-24-31PE
24-33	HDP20	HDP26-24-33SN	HDP24-24-33PN	HDP26-24-33SE	HDP24-24-33PE
	HD30	HD36-24-33SN	HD34-24-33PN	HD36-24-33SE	HD34-24-33PE
24-35	HDP20	HDP26-24-35SN	HDP24-24-35PN	HDP26-24-35SE	HDP24-24-35PE
	HD30	HD36-24-35SN	HD34-24-35PN	HD36-24-35SE	HD34-24-35PE
24-47	HDP20	HDP26-24-47SN	HDP24-24-47PN	HDP26-24-47SE	HDP24-24-47PE
	HD30	HD36-24-47SN	HD34-24-47PN	HD36-24-47SE	HD34-24-47PE

Note

Undersize wire insulation is a major cause for leakage.

HD30 & HDP20 Series

WIRE SEALING RANGE

The wire sealing range is the recommended outside diameter of the wire insulation required to maintain an environmental seal in the rear connector cavities.

Contact Size	N-Seal Green Ring	T-Seal Gray Ring	T-Seal Modified*	E-Seal Blue Ring	E-Seal Modified*
20 14-22 AWG (2.5-0.35mm ²)	.040-.095 (1.02-2.41)	.040-.095 (1.02-2.41)	-	.040-.095 (1.02-2.41)	.040-.083 (1.01-2.10)
16 14-20 AWG (2.0-0.5mm ²)	.100-.134 (2.54-3.40)	.088-.134 (2.23-3.40)	.088-.106 (2.24-2.69)	.053-.120 (1.35-3.05)	.053-.103 (1.35-2.62)
12 10-14 AWG (6.0-2.0mm ²)	.134-.170 (3.40-4.32)	.113-.170 (2.87-4.32)	-	.097-.158 (2.46-4.01)	.097-.158 (2.46-4.01)
8 8-10 AWG (10.0-5.0mm ²)	.190-.240 (4.83-6.10)	.170-.240 (4.32-6.10)	-	.135-.220 (3.43-5.59)	-
4 6 AWG (16.0-13.0mm ²)	.280-.292 (7.11-7.42)	.261-.292 (6.63-7.42)	-	.261-.292 (6.63-7.42)	-
4 4 AWG (25.0-21.0mm ²)	.311-.420 (7.90-10.67)	-	-	-	-

*DEUTSCH cavity arrangements 24-29, 24-47, and 24-31 are only available with the modified seals. Arrangement 24-31 Modified E Seal = .053-.106. Please see drawings 0425-016-0000 and 0425-021-0000 for full specifications.

Color code is visible from the rear of the receptacle or plug.

- Green:** Normal Seal
- Gray:** Thin Wall Seal
- Blue:** Extra Thin Wall Seal



helpful hint

Proper wire outside diameters help provide water tight seals.

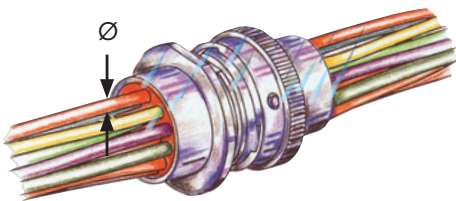

HD30 & HDP20 Series

Special Modifications

The HD30 & HDP20 series connectors offer several modifications to enhance design flexibility and meet application specific needs. Options include breakaway plugs, adapters, and high amperage options just to mention a few. By combining the HD30 & HDP20 series connectors with the available modifications and accessories, the design possibilities are greatly expanded.



HDB - BREAKAWAY PLUG (HD30 SERIES ONLY)

The HDB breakaway plug is designed to provide an emergency disconnect between farm tractors and implements that require power connections. The HDB breakaway plug is designed to break the connection before damaging the wiring system. These plugs can be specified with pin or socket contacts and connect only with the HD30 series receptacles. As an added design convenience, the HDB breakaway plug is also available with an optional cable clamp (059 mod). Breakaway function occurs at an axial load of 50-100 lbs.



L015
Threaded
Adapter



L017
Ring Adapter



L024
Wide Threaded
Adapter

L015/L017/L024 MODIFICATIONS

The L015/L024 threaded adapters and L017 ring adapter modifications are available for the DEUTSCH HDP20 series connectors. These adapter modifications provide simple, low cost assembly solutions for applications that require a backshell or conduit. The adapters are designed to be used with the backshell of your choice.

- The L015 threaded adapter is available on size 24 shells in the HDP20 series.
- The L017 ring adapter is available on size 24 or size 18 shells in the HDP20 series.
- The L024 wide threaded adapter is available on size 24 or size 18 shells in the HDP20 series.



C030 MODIFICATION

Originally designed for multiplexing and battery cable applications, the DEUTSCH C030 modification is an environmentally sealed, heavy duty two cavity connector that accepts size 4 solid contacts rated up to 100 amps for each cavity.



The C030 modification is available in size 18 shell in both metal (HD30 series) and thermoplastic (HDP20 series) to meet your heavy wire gauge application needs.

HD30 & HDP20 Series



C041/CL20 MODIFICATIONS

The C041 and CL20 modifications are available for the DEUTSCH HDP20 series 14 pin connector. The C041 modification features a data link key and reduced diameter seals on the receptacle. The CL20 modification includes a ring adapter, reduced diameter seals, and a data link key on the plug.

CABLE CLAMP/BACKSHELL MODIFICATIONS



DEUTSCH cable clamps provide positive support to the wire bundle while reducing strain on the connector. The backshell is available with or without drain holes.

Part Number Suffix	Description
-072	Adapter only
-059	Adapter and cable clamp assembly with drain holes
-L006	Adapter and cable clamp assembly without drain holes

Accessories

Several accessory items can be used to complement the connectors. The HD30 & HDP20 family accessories include items such as boots, backshells, gaskets, and protective caps. Accessories are designed to complete the application and meet a wide array of design requirements such as solutions for mounting, providing additional protection, and offering increased aesthetics.

BOOTS



Boots provide a professional looking finishing touch for the DEUTSCH HD30 & HDP20 family of connectors. Made of durable plastisol, these slip-on boots are not only aesthetically appealing, but also provide increased protection from dirt, paint overspray, and pressure washing. The plastisol boots are rated from -20°F to +212°F (-28°C to +100°C) and offer a slip-on design making installation quick and easy.



Part Number	Description
HD30-18BT	18 shell size boot, gray
HD30-18BT-BK	18 shell size boot, black
HD30-18BT-90-BK	18 shell size boot, 90° bend, black
LC-90BT-HT	18 shell size boot, 90° bend, high temperature material, yellow
HD30-24BT	24 shell size boot, gray
HD30-24BT-BK	24 shell size boot, black
HD30-24BT-90-BK	24 shell size boot, 90° bend, black
MT-90BT-HT-24	24 shell size boot, 90° bend, high temperature material, yellow

*Distorting the boots can lessen their longevity

HD30 & HDP20 Series

PROTECTIVE DUST CAPS

Protective caps are available for both plug and receptacle halves of the connectors. The metal caps, for use with the HD30 series, come with a mounting chain and are used to protect the connector while not mated. The thermoplastic caps, for use with the HDP20 series, are available with or without a lanyard.

HDP20 Series Dust Caps



Shell Size	Part Number	Description
18	HDC26-18	Plug cap for receptacle protection, environmentally sealed
24	HDC26-24	

HD30 Series Dust Caps



Shell Size	Part Number	Description
18	HDC36-18	Plug cap for receptacle protection
24	HDC36-24	
18	HDC34-18	Receptacle cap for plug protection
24	HDC34-24	

To order HD30(HD3-**) protective caps without the mounting chain, add -1E to the end of the part number

STRAIN RELIEF

The DEUTSCH HD30 & HDP20 series connectors offer several backshell options to meet your design needs. Backshell options include straight or 90° and plastic or metal. The metal backshells work best with the HD30 series. It is attached to the rear of the connector using an adjustable screw and is secured to the wire bundle with the use of a tie wrap. The plastic backshells work best with the HDP20 series and attach to the rear of the connector with either a clamshell snap closure or by screwing them on to a threaded adapter. The rigid, durable backshells offer a high level of protection, provide strain relief, and improve aesthetics.



Shell Size	Orientation	HD30 Series Backshell Part Number
18	Straight	WHDS-18-1
24		WHDS-24-1
18	90°	WHDS-18-2
24		WHDS-24-2

HD30 & HDP20 Series



Shell Size	Orientation	HDP20 Series L017 Backshell	
		Part Number	Conduit Size
18	Straight	2428-016-1805	13, 17, 19 (mm) NW
	90°	2428-015-1805	13, 17, 19 (mm) NW
24	Straight	2428-008-2405	1"
	90°	2428-004-2405	1"
24	Straight	2428-010-2405	17, 19, 23, 26 (mm) NW
	90°	2428-011-2405	17, 19, 23, 26 (mm) NW

NW = Nominal Width of the conduit's inside diameter. See drawings for full specifications.



Seal Ring

Cap Nut

Shell Size	HDP20 Series L015 Conduit Adapter		Conduit Size
	Part Number	Part Number	
24	Seal Ring SRN21	Cap Nut CN21	22 (mm) NW

BACKSHELLS FOR L015 MODIFICATION



The DEUTSCH HDP20 series backshells are designed to screw onto connectors with the L015 modification, which adds a threaded adapter. Rated for temperatures from -40°C to +134°C, the rigid, durable backshells offer a high level of protection, provide strain relief, and improve aesthetics.

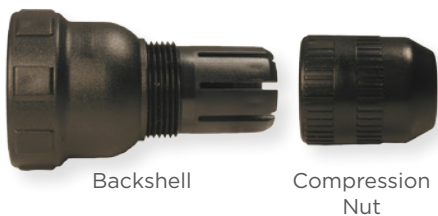

Backshell

Compression Nut

Shell Size	Cable Diameter	HDP20 Series L015	
		Backshell Part Number	Compression Nut Part Number
24	.430-.570	M902-2243	M902-2053
	.570-.710	M902-2244	M902-2054

Backshell Technical Specifications:

Material - PC/PET Polyester Blend, UV-Stabilized, Flame Retardant, Black
Flammability - material meets UL94-VO, Weatherability - UL746C

HD30 & HDP20 Series

BACKSHELLS FOR L024 MODIFICATION

The DEUTSCH HDP20 series backshells are designed to screw onto connectors with the L024 modification, which adds a wide threaded adapter. The rigid, durable backshells offer a high level of protection, provide strain relief, and improve aesthetics.



Shell Size	Orientation	HDP20 Series L024 Backshell Part Number
18	Straight	2428-025-1805
24		2428-024-2405

GASKETS



Moisture, dirt, salt, sand, and road debris can all work their way into electrical panels through unsealed mounting flanges. Rated to operate in environments from -70°F to +225°F (-56°C to +107°C), these rugged high quality neoprene gaskets form a tight seal between the panel face and connector flange to help keep out destructive elements. The gaskets have a thickness of .125" and the material meets the UL-94-HBF, Mil-R-6130C, and FMVSS-302 flammability specifications.

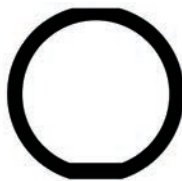

Receptacle Shell Size	Gasket Part Number
18	16-04978
24	16-04477

MOUNTING HARDWARE

DEUTSCH lockwashers and panel nuts are available to aid in mounting the HD30 and HDP20 series connectors. The lockwashers are used to add tension between the threads and the nut to provide a secure mount. The lockwasher and the panel nut should be used together.

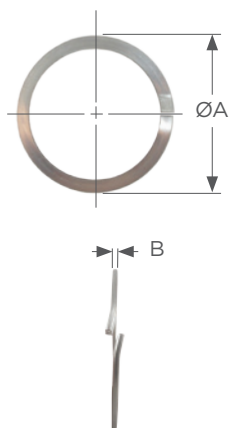

Shell Size	Series	Panel Lockwasher Part Number	ØA	B
18	HDP20	2414-002-1886	1.892 (48.06)	-
	HD30	114021	1.699 (43.15)	.062 (1.57)
24	HDP20	2414-001-2486	2.080 (52.83)	-
	HD30	112264	1.887 (47.93)	.062 (1.57)

Dimensions are for reference only

HD30 & HDP20 Series

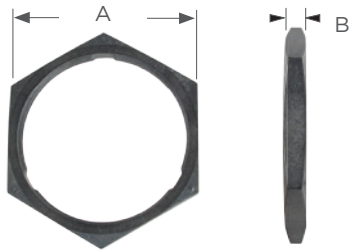

Panel Nut Mounting Torque

HD30 series 18 shell size	260-280 IN. LB. (29.4-31.6 N.M.)
HDP20 series 18 shell size	45-55 IN. LB. (5.1-6.1 N.M.)
HD30 series 24 shell size	350-375 IN. LB. (39.5-42.6 N.M.)
HDP20 series 24 shell size	65-75 IN. LB. (7.4-8.4 N.M.)

Shell Size	Series	Panel Nut Part Number	Material	A	B
18	HDP20	2411-002-1805	Plastic	1.685 (42.80)	.250 (6.35)
	HD30	114020-90	Metal		.178 (4.52)
24	HDP20	2411-001-2405	Plastic	1.875 (47.63)	.250 (6.35)
	HD30	112263-90	Metal		.178 (4.52)

Dimensions are for reference only

Mounting

RECEPTACLE MOUNTING

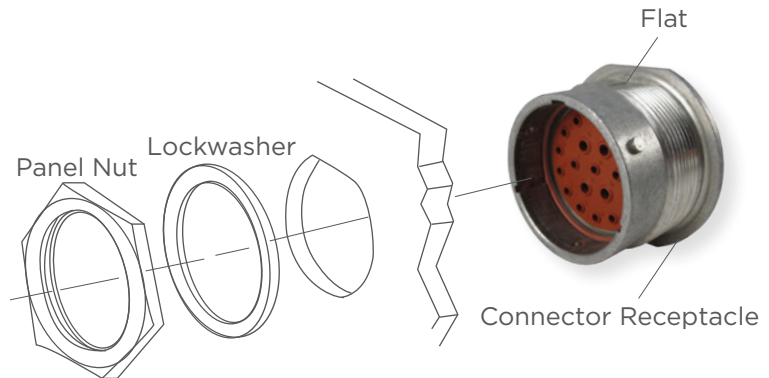
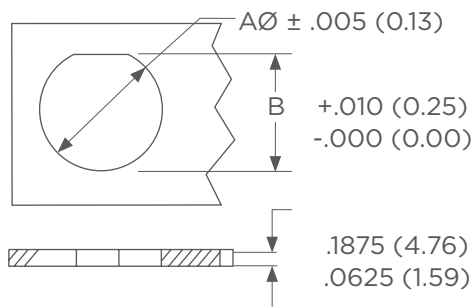

Recommended Size of Mounting Hole

Shell Size	ØA	B
18	1.507 (38.28)	1.442 (36.63)
24	1.696 (43.08)	1.632 (41.45)

Dimensions are for reference only

helpful hint

Mounting connectors horizontally allows proper water drainage.

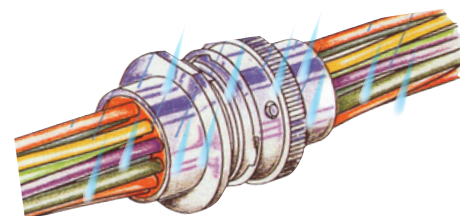

HD30 & HDP20 Series

D HOLE PUNCH



The D hole punch is a hand tool used to cut a D shaped hole. The D shaped hole allows the connector to be securely mounted and helps prevent the connector from spinning.



- Punchable Material: Up to .078" mild steel or aluminum. Up to .1875" plastic, wood, paneling, or other soft material.
- Tool Material: A2 material heat treated to a Rockwell hardness of 60 to 62.
- Tool Size: (rough dimensions) 5.5"L x 2"H x 2"D
- Sharpening: The tool can be sharpened as needed.
- Usability: A .625" minimum pilot hole is required to accommodate the draw stud. Air tools can be used.

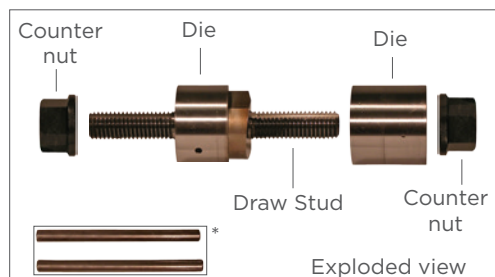

*The rods included with the "D" hole punch are used to remove the cutout and are not used in the cutting process.

Shell Size	D Hole Punch Part Number
18	18-D-PUNCH
24	24-D-PUNCH

How To Instructions

MATING INSTRUCTIONS

To mate the plug and the receptacle, line up the index groove on the plug with the flat surface on the receptacle, turn 1/4 turn clockwise. You will feel and hear the pieces snap into the locked position. To unmate the plug and receptacle, release the coupling ring by turning it counter-clockwise.

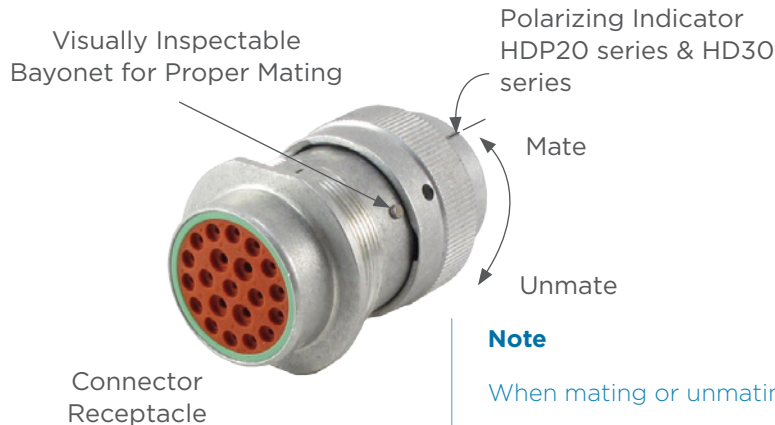
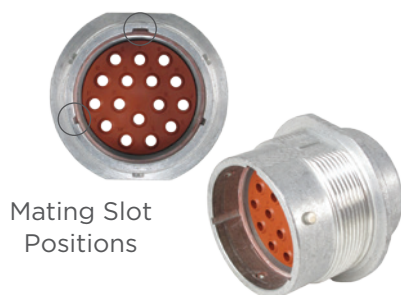

Note

When mating or unmating connectors, disassemble by hand. Do not use pliers or any other tool.

CONTACT INSERTION

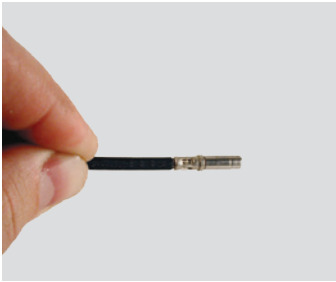

Step 1:
Grasp contact approximately one inch behind the contact crimp barrel.

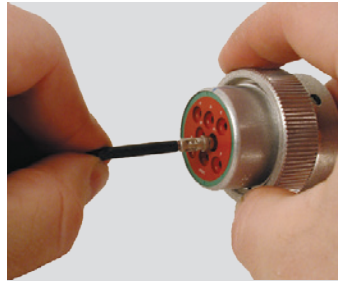

Step 2:
Hold connector with the rear grommet facing you.

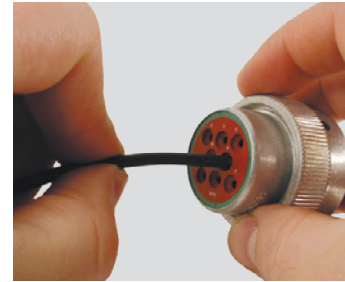

Step 3:
Push contact straight into connector grommet until a positive stop is felt. A slight tug will confirm that it is properly locked in place.

CONTACT REMOVAL

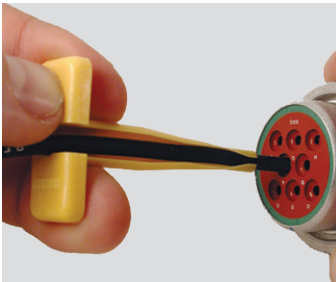

Step 1:
With rear insert toward you, snap appropriate size removal tool over the wire of contact to be removed.

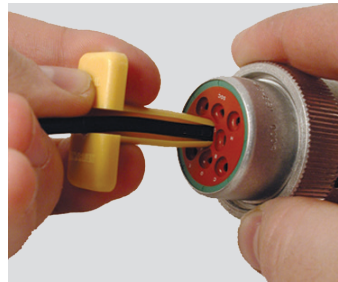

Step 2:
Slide tool along the wire into the insert cavity until it engages contact and resistance is felt.

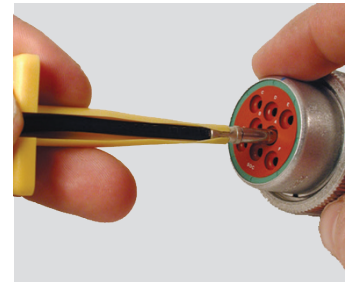

Step 3:
Pull contact wire assembly out of connector.

Note

Do not twist or insert tool at an angle.

Contents

STRIKE Series Overview	162
Performance Specifications	162
Material Specifications	162
Dimensions	163
Configurations	163
Ordering Information	164
Accessories	165
How To Instructions	166-167

STRIKE Series

STRIKE Series Overview

The STRIKE connector series features a lever lock system and is designed for heavy duty equipment applications. The environmentally sealed series offers two different size rugged housings that accept contacts from size 20 to 16 with arrangements of 32 and 64 cavities.



DEUTSCH CONNECTOR PERFORMANCE SPECIFICATIONS

Temperature:	Operating at temperatures -55°C to +125°C
Durability:	No electrical or mechanical defects after 100 cycles of engagement and disengagement.
Vibration:	No unlocking or unmating and exhibits no mechanical or physical damage after sinusoidal vibration levels of 20 G's at 10 to 2000 Hz in each of the three mutually perpendicular planes. No electrical discontinuities longer than 1 microsecond.
Fluid Resistance:	Connectors show no damage when exposed to most fluids used in industrial applications.
Insulation Resistance:	1000 megohms minimum at 25°C.
Immersion:	IP68 rating
Moisture Resistance:	Properly wired and mated connections will withstand immersion under three feet of water without loss of electronic qualities or leakage.
Dielectric Withstanding Voltage:	Current leakage less than 2 milliamps at 1500 volts AC.
Thermal Cycle:	No cracking, chipping or leaking after 20 test cycles from -55°C to +125°C.

MATERIAL SPECIFICATIONS

Flange Seal:	Silicone rubber
Plug Grommet:	Silicone rubber
Receptacle Threaded Inserts:	Brass
Shell:	Glass filled PBT
TPA:	Glass filled PBT

STRIKE Series

DIMENSIONS

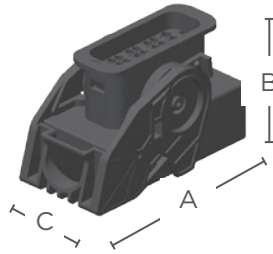

STRIKE Plug

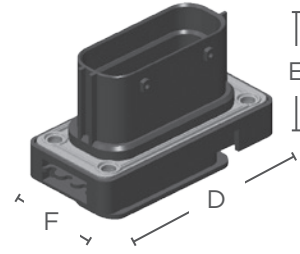

STRIKE Receptacle

Cavity	Overall Length A	Overall Height B	Overall Width C	Overall Length D	Overall Height E	Overall Width F
MD	3.189 (81.00)	1.909 (84.50)	1.531 (38.90)	3.228 (82.00)	2.205 (56.00)	1.575 (40.00)
FL	3.358 (85.28)	1.913 (48.60)	2.780 (70.60)	3.228 (82.00)	2.205 (56.00)	2.953 (75.00)

Dimensions are for reference only.

CONFIGURATIONS

Connector Styles

I	In-line
F	Flange Mount Receptacle
P	PCB Receptacle

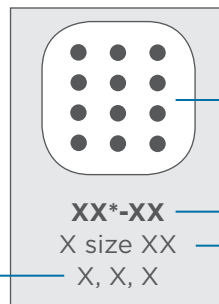

Insert Arrangement

Shell Size/Key - Configuration Number and Size of Cavities

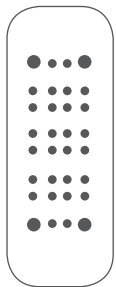

MD*-32A
4 Size 16
28 Size 20
I, F, P

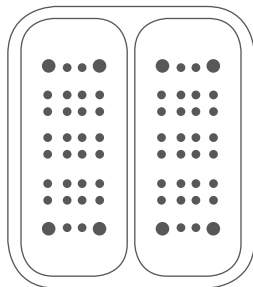

FL*-64A
8 Size 16
56 Size 20
I, F

STRIKE Series

PART NUMBERING SYSTEM

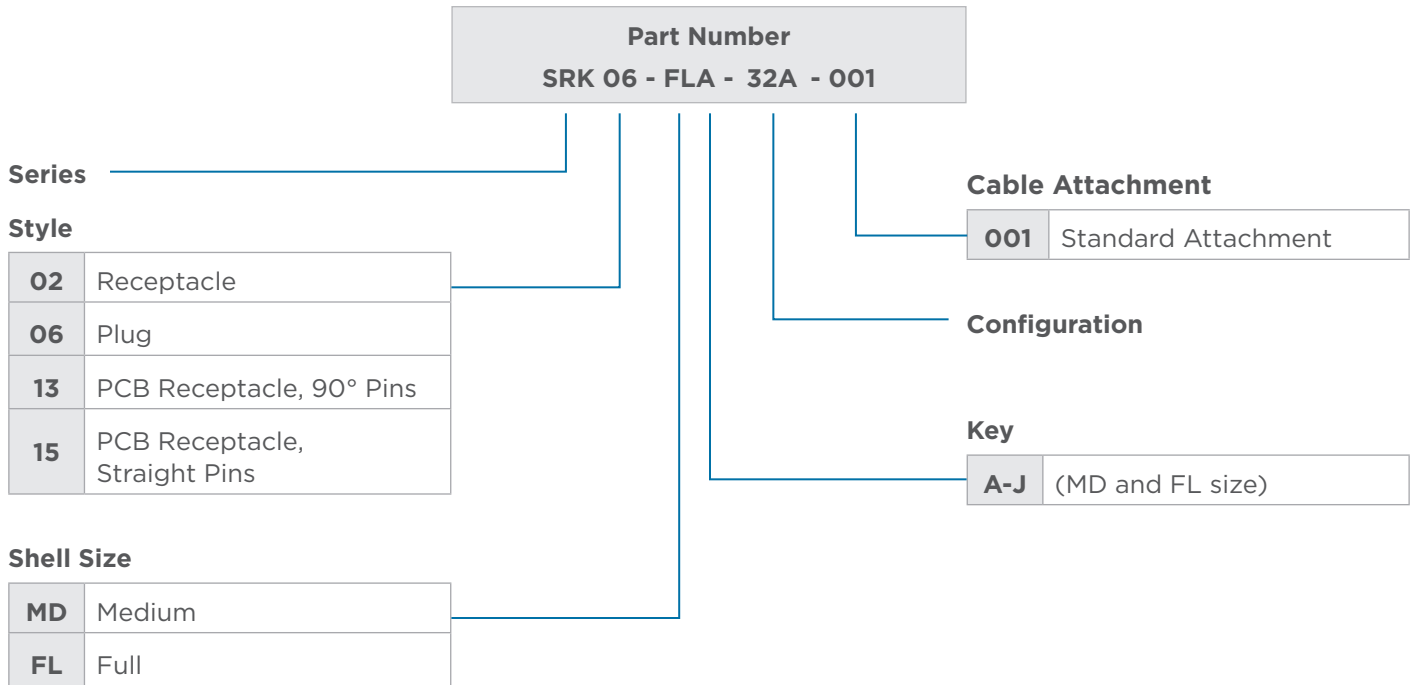

ORDERING INFORMATION

Here are some of the common part numbers of the STRIKE connectors. Several additional connectors may be available.

Position	Keying	Plug	Receptacle
32	A	SRK06-MDA-32A-001	SRK02-MDA-32A-001
	B	SRK06-MDB-32A-001	SRK02-MDB-32A-001
	C	SRK06-MDC-32A-001	SRK02-MDC-32A-001
64	A	SRK06-MDA-64A-001	SRK02-MDA-64A-001
	B	SRK06-MDB-64A-001	SRK02-MDB-64A-001
	C	SRK06-MDC-64A-001	SRK02-MDC-64A-001

STRIKE Series

WIRE SEALING RANGE

The wire sealing range is the recommended outside diameter of the wire insulation required to maintain an environmental seal in the rear connector cavities.

Contact Size	Standard Seal
20 16-22 AWG (1.0-0.35mm ²)	.061-.095 (1.55-2.41)
16 14-20 AWG (2.0-0.5mm ²)	.061-.120 (1.55-3.05)

Accessories

Backshells can be used to complement STRIKE connectors. The backshells are designed to snap onto the connectors and accept convoluted tubing. The backshells assist with wire routing to ease engagement and disengagement of the lever lock.



Part Number	Size	Orientation	Convoluted Tubing	Description
SRK-BS-MD-90-001 SRK-BS-MD-90-002	Medium	90°	NW17 & 22(-001) NW22(-002)	90° plastic backshell for medium or full size plugs and receptacles
SRK-BS-FL-90-001 SRK-BS-FL-90-002	Full		NW22 & 26(-001) NW26(-002)	
SRK-BS-MD-ST-001 SRK-BS-MD-ST-002	Medium	Straight	NW17(-001) NW22(-002)	Straight plastic backshell for medium or full size plugs and receptacles
SRK-BS-FL-ST-001 SRK-BS-FL-ST-002	Full		NW22(-001) NW26(-002)	

How To Instructions

CONTACT INSERTION



Step 1:
Confirm TPA locking is open.



Step 2:
Hold connector with rear seal retainer facing you.

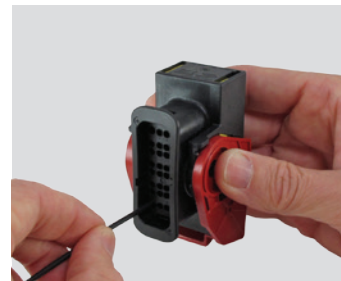

Step 3:
Push contact straight into the grommet until a positive stop is felt. A slight tug will confirm that it is properly locked in place.



Step 4:
Push to close the TPA.
TPA will not close unless all contacts are fully seated in connector.

STRIKE Series

CONTACT REMOVAL

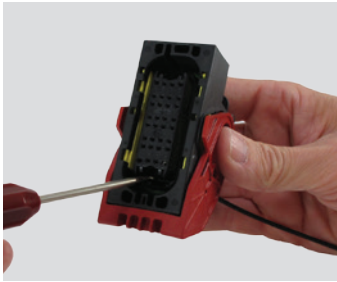

Step 1:
Use DT-RT1 to gently pry the locking clip and release the TPA.

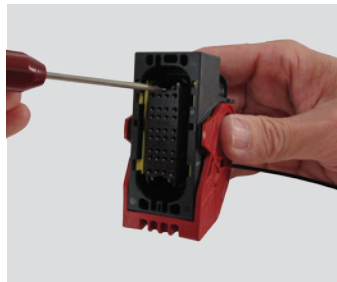

Step 2:
Repeat step 1 on the other side of the TPA.

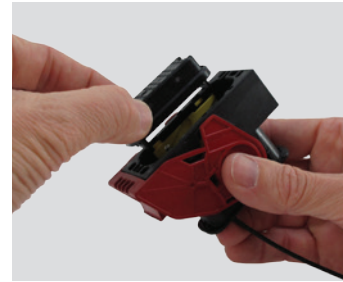

Step 3:
Remove the TPA.



Step 4:
Unlock the contacts and pull on the wire.

STRIKE Series

NOTES:

Contents

Common Contacts Overview	170
Performance Specifications	171
Wire Sealing Ranges.....	101
Solid Contact Part Numbers.....	172
Stamped & Formed Contacts	
Part Numbers.....	173
PCB Pins	174
Crimping.....	175
Crimp Inspection.....	176
Accessories.....	177-178
How To Instructions	179-180

DEUTSCH Common Contacts Overview

Several contacts are used interchangeably across most DEUTSCH connector product lines. This commonality improves performance, reliability, and maintainability by reducing changes in the assembly of the wire harness. The use of the same contact system helps eliminate many of the failures reported in harnesses where hundreds of different terminations are used.

CONTACT STYLES

Two styles of contacts are available: solid and stamped & formed. Both contact types use a crimp style termination, eliminating the need for solder. The variations in the contact system are those dictated by wire gauge and contact style.

Solid

The solid contacts are designed for use with larger wire size and heavy duty applications. Solid contacts are manufactured using a cold heading process with solid copper alloy wire and are available with either a nickel or gold plating finish.

Solid contacts terminate wire from 4 AWG to 20 AWG (25 - 0.5mm²) and are available in 5 sizes each of the pin and socket. The applicable contact is determined by the size of the conductor only.



Stamped & Formed

Stamped & formed contacts are designed for use where wire termination costs are of primary concern without sacrificing reliability of electrical circuits. The stamped & formed contacts are made on a precision stamping machine using flat strip stock, then a durable and corrosion proof nickel, tin, or optional gold plating is applied.

The stamped & formed style contacts terminate wire from 10 AWG to 22 AWG (6.0 - 0.35mm²) and are available in multiple sizes to accommodate a wide range of wire insulation. The specific contact is determined by the outside diameter of wire insulation and conductor size.



DEUTSCH Common Contacts

DEUTSCH CONTACT PERFORMANCE SPECIFICATIONS

Durability

No electrical or mechanical defects after 100 cycles of engagement and disengagement.

Current Rating (Contact current rating at 125° C continuous)

Contact Size	Max. Current
Size 20	7.5 amps
Size 16	13 amps
Size 12	25 amps
Size 8	60 amps
Size 4	100 amps

Contact Retention (Solid and Stamped & Formed)

Contacts withstand a minimum load of:

- 20 lbs (89 N) for size 20
- 25 lbs (111 N) for size 16
- 30 lbs (133 N) for size 12
- 35 lbs (156 N) for size 8
- 35 lbs (156 N) for size 4

Contact Millivolt Drop

Contact Size	Test Current Amps	Millivolt Drop* (Solid)	Millivolt Drop* (S&F)
20	7.5	60	100
16	13	60	100
12	25	60	100
8	60	60	-
4	100	60	-

*Less drop through wire

Crimp Tensile Strength (Solid)

Contact Size	Tensile Strength
Size 20	20 lbs
Size 16	25 lbs
Size 12	70 lbs
Size 8	90 lbs
Size 4	300 lbs

Crimp Tensile Strength (Stamped & Formed)

Contact Size	Tensile Strength
Size 20	20 lbs
Size 16	25 lbs
Size 12	70 lbs

helpful hint

A crimp tensile test easily and rapidly identifies a proper crimp.



DEUTSCH Common Contacts

SOLID CONTACT PART NUMBERS

Size	Solid Contact Part Numbers		Wire Size AWG (mm ²)	Recommended Strip Length Inches (mm)	Min. Contact Retention	Ref Crimp Tensile Lbs. (N)	Max Rated Amps at 125° C Continuous
	Pin	Socket					
20	0460-202-20**	0462-201-20**	20 (0.50)	.156-.218 (3.96-5.54)	20 (89)	20 (89)	7.5
20	0460-010-20**	0462-005-20**	16-18 (1.0-0.75)	.156-.218 (3.96-5.54)	20 (89)	20 (89)	7.5
16	0460-202-16**	0462-201-16**	16-20 (1.5-0.50)	.250-.312 (6.35-7.92)	25 (111)	35-20 (156-89)	13
16	0460-215-16**	0462-209-16**	14 (2.0)	.250-.312 (6.35-7.92)	25 (111)	70 (311)	13
12	0460-204-12**	0462-203-12**	12-14 (3.0-2.0)	.222-.284 (5.64-7.21)	30 (134)	75-70 (334-311)	25
8	0460-204-08**	0462-203-08**	8-10 (10.0-5.0)	.430-.492 (10.92-12.50)	35 (156)	125-90 (556-400)	60
4	0460-204-04**	0462-203-04**	6 (16.0-13.0)	.430-.492 (10.92-12.50)	35 (156)	300 (1334)	100
4 (C038)	5960-203-04141	5962-203-04141	4 (25.0-21.0)	.430-.492 (10.92-12.50)	35 (156)	300 (1334)	100

** = Plating codes

Solid Contact Plating Codes

Part Number Suffix	Plating Material
31	Gold
90	Nickel (size 4 pin only)
141	Nickel

Note

See information drawing
0425-015-0000.



DEUTSCH Common Contacts

STAMPED & FORMED CONTACT PART NUMBERS

Size	S&F Contact Part Numbers		Carrier Strip	Wire Size AWG (mm ²)	Wire Insulation O.D. Range	Recommended Strip Length Inches (mm)	Min. Contact Retention	Max Rated Amps at 125° C Continuous
	Pin	Socket						
20	1060-20-01**	1062-20-01**	20-01	16-22 (1.5-0.35)	.075-.125 (1.91-3.18)	.150-.200 (3.81-5.08)	20 (89)	7.5
20	1060-20-02**	1062-20-02**	20-02	16-22 (1.5-0.35)	.051-.085 (1.30-2.16)	.150-.200 (3.81-5.08)	20 (89)	7.5
20	-	1062-20-03** sleeveless	20-03	16-22 (1.5-0.35)	.075-.125 (1.91-3.18)	.150-.200 (3.81-5.08)	20 (89)	7.5
20	1060-20-06**	1062-20-06**	20-06	14-16 (2.5-1.0)	.075-.125 (1.91-3.18)	.150-.200 (3.81-5.08)	20 (89)	7.5
16	1060-14-01**	1062-14-01**	14-16	14-18 (2.0-.75)	.095-.150 (2.41-3.81)	.150-.200 (3.81-5.08)	25 (111)	13
16	1060-14-10**	1062-14-10**	14-16	14-18 (2.0-.75)	.095-.150 (2.41-3.81)	.150-.200 (3.81-5.08)	25 (111)	13
16	1060-16-01**	1062-16-01**	16-18	14-18 (2.0-.75)	.075-.140 (1.90-3.55)	.150-.200 (3.81-5.08)	25 (111)	13
16	1060-16-06**	1062-16-06**	0.5-1.0	16-20 (1.0-.50)	.055-.100 (1.40-2.54)	.150-.200 (3.81-5.08)	25 (111)	13
16	1060-16-09**	1062-16-09**	16-18	14-18 (2.0-.75)	.075-.140 (1.90-3.55)	.150-.200 (3.81-5.08)	25 (111)	13
16	1060-16-12**	1062-16-12**	1.0-2.5	12-16 (2.5-1.0)	.075-.140 (1.90-3.55)	.175-.225 (4.45-5.72)	25 (111)	13
16	-	1062-16-14** sleeveless	14-16	12-16 (2.5-1.0)	.075-.140 (1.90-3.55)	.175-.225 (4.45-5.72)	25 (111)	13
12	1060-12-01**	1062-12-01**	12-14	12-14 (4.0-2.0)	.113-.176 (2.87-4.47)	.225-.275 (5.72-6.99)	30 (134)	25
12	1060-12-02**	1062-12-02**	10-12	10 [†] (6.0-4.0)	.140-.204 (3.56-5.18)	.225-.275 (5.72-6.99)	30 (134)	25

** = Plating codes

† = TXL wire insulation is preferred

S&F Contact Plating Codes

Part Number Suffix	Plating Material
22	Nickel
44	Gold
66	Tin/Nickel
77	Tin
88	Selective Gold

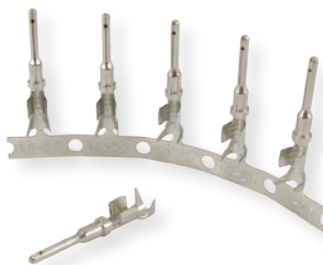

Note

See information drawing 0425-015-0000.

DEUTSCH Common Contacts

PCB PINS

Straight reduced diameter extended pins are available for installation in the DEUTSCH family of connectors. The use of removable contacts provides design flexibility and a low cost alternative to meet application needs. These solid copper alloy pins may be specified in various platings and assembled in HD30, HDP20, HD10, DRC, or DT receptacles.

Material

Copper alloy

Plating Codes

31: Gold

90: Tin

141: Nickel



PCB Mounting

Consult factory for PCB mounting details and pin positions.

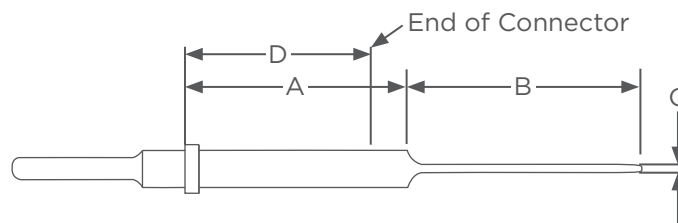

Note

See information drawing 0425-202-0000 for full specifications.

Contact Size

Contact Size	Part Number	A	B	C	Series	D*
20	0460-208-2031	1.305 (33.15)	.248 (6.30)	.025 (.64)	HD30/HDP20	.939 (23.85)
	0460-208-2090	1.305 (33.15)	.248 (6.30)	.025 (.64)	HD10	.925 (23.50)
16	0460-208-16141	1.300 (33.02)	.248 (6.30)	.025 (.64)	DT	.777 (19.74)
	0460-208-1631	1.300 (33.02)	.248 (6.30)	.025 (.64)	DT04-2P	.677 (17.20)
	0460-229-16141	.545 (13.84)	.248 (6.30)	.025 (.64)	DT04-3P	.677 (17.20)
	0460-241-16141	1.305 (33.15)	.160 (4.06)	.040 (1.02)	DRC	1.063 (27.00)
	0460-244-16141	.976 (24.79)	.400 (10.16)	.041 (1.04)		
	0460-244-1631	.976 (24.79)	.400 (10.16)	.041 (1.04)		
12	0460-208-12141	1.305 (33.15)	.248 (6.30)	.025 (.64)		
	0460-245-1231	1.024 (26.01)	.500 (12.70)	.041 (1.04)		
	0460-245-1290	1.024 (26.01)	.500 (12.70)	.041 (1.04)		

*D is equal to the distance from the contact shoulder to the end of the connector.

Dimensions are for reference only.



HD10 Series



HDP20 Series



HD30 Series

Crimping

Crimping is defined as the act of joining a conductor to a pin or socket contact using a mechanical tool to compress and displace metal. In a good crimp joint, there is mutual flow of metal, causing a symmetrical distortion of wire strands.

CRIMPING CONFIGURATIONS

Stamped & formed contacts use a folded type of crimp (Fig. 1) while solid contacts use a 1, 2, or 4 indent crimp (Fig. 2). In both styles of crimps, the wire strands and the contact material are formed together in a solid mass creating a reduction of the wire strand area. The reduced wire strand area creates a minimum of voids allowing for excellent conductivity. Crimping may be accomplished with hand tools or power tools.

BENEFITS OF CRIMPED CONTACTS

Mechanically crimping contacts is the leading wire termination method for some very good reasons:

- With smaller wire, the crimp is as strong as the wire itself.
- The joint can be visually inspected. Viewing the wire through an inspection hole in the contact makes inspection quick and easy, both by the operator and the inspector.
- Plating thickness is not restricted, as in solder joints, so better corrosion resistance and contact reliability are achieved.
- Crimping can be done anywhere, without special preparation. Terminations are replaced or modified in the field exactly the same as in the shop, using the same tools and the same techniques, and with the same ease of operation and certainty of results.
- Total installed and maintenance costs are lower.

helpful hint

Solder should not be added to DEUTSCH terminals.



Stamped & Formed Style



Cross-Section Across Axis

Figure 1

Solid Style



Indenter Crimp
Cross-Section Across Axis

Figure 2

Note

The use of dielectric grease is not recommended.

CRIMP INSPECTION

Crimping tools provide lower total installation and maintenance costs. However, controls are required to help confirm that the proper crimp tools designed for the type and size contact are used, the pin or socket is properly inserted into the tool, the wire insulation is stripped properly, and the wire fully inserts into the contact.

When a crimp is completed, correct termination can be visually inspected. The inspector should check for:

- The removed insulation should expose a conductor length that will pass beyond the inspection hole in the contact and still reveal the appropriate length of conductor between the contact and the insulation on the wire.
- Wire strands intact.
- All wire strands enter the contact barrel.
- Wire inserted to the proper depth in the contact.

When the correct crimp tool and process are used, a good termination results.

Note

For more detailed crimp dimensions please request a drawing.

SOLID CONTACT CRIMP

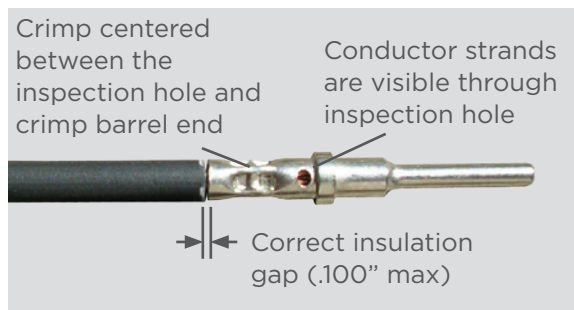

Acceptable Crimp

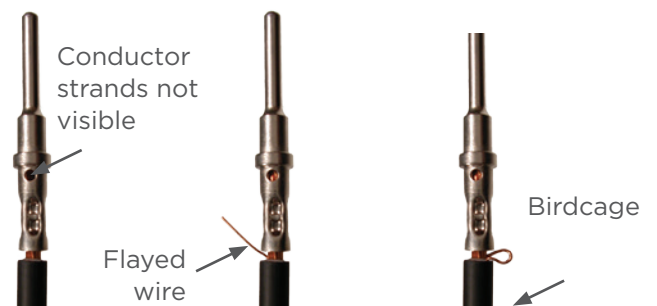

Unacceptable Crimps

STAMPED & FORMED CONTACT CRIMP

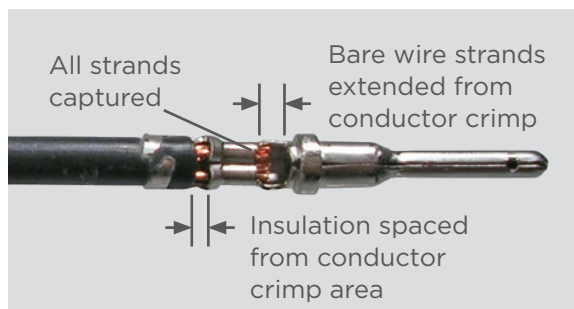

Acceptable Crimp

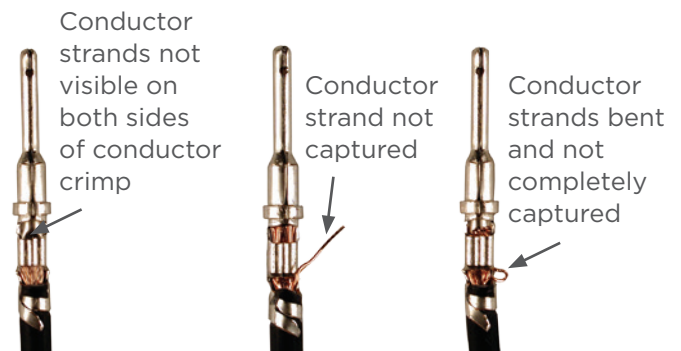

Unacceptable Crimps

DEUTSCH Common Contacts

Accessories

Additional accessories are available to aid in the design flexibility and sealing requirements of applications. Accessory items such as sealing plugs and keying pins help to maintain an environmental seal and prevent mis-mating.

KEYING PINS

Keying pins are solid plastic rods used to help prevent mis-mating of like connectors in close proximity. Applicable DEUTSCH product lines include HD10, HD30, HDP20, DT, and DTM series.

Keying pins are inserted into the retention fingers of an empty socket cavity. Once installed, the keying pin blocks a mating contact pin from being inserted. The contact pin will be blocked before the coupling device mates the connectors, helping to prevent the mis-mating of like connectors. Proper usage requires that the corresponding mating pin be omitted and a sealing plug inserted in the rear cavity of the mating connector. Individual applications will vary, and testing should be done to determine the best pattern arrangement to help prevent improper connector mating.



Part Number	Contact Size	Color
0413-216-2005	20	Red
0413-215-1605	16	White
0413-214-1205	12	Yellow

Note

Multiple keying pins may be required to help prevent unintentional forced mating.

CONTACT CRIMP SLEEVE REDUCER

A crimp sleeve reducer is available to allow DEUTSCH size 4 solid contacts to accept 8-10 AWG wire. When populating a connector using a contact with a reducer sleeve, be sure the insert seal penetrates the rear grommet. The use of the crimp sleeve reducer requires no extra crimp tools and provides an easy transition and increased flexibility.



Insert Seal
0410-241-0406



Crimp Sleeve
0421-203-04141

Note

TXL wire insulation with 10 AWG is not recommended because it may not provide an environmental seal against the insert seal.

SEALING PLUGS

Open cavities provide pathways for contaminants to enter the connectors. To maintain seal integrity, any unused cavity must be filled with the appropriate size sealing plug.



Part Number	Contact Size	Description
114019	Size 4	Silicone rubber
114018	Size 8	Thermoplastic
114017	Size 12, 16	Thermoplastic
0413-217-1605 (locking sealing plug)	Size 16	Thermoplastic, retained by locking fingers
0413-003-1605	Size 16	Thermoplastic, used with STRIKE series
0413-204-2005	Size 20	Thermoplastic

helpful hint

Sealing plugs are used to seal the connector when all the cavities are not used by wires.

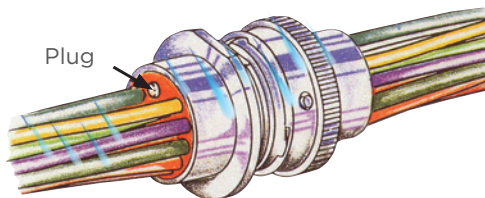

How To Instructions

SEALING PLUG INSTALLATION

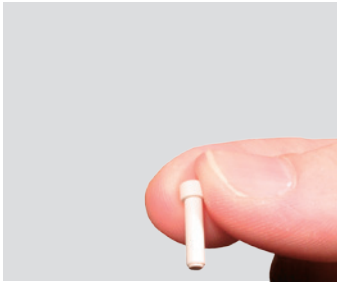

Step 1:

Holding the sealing plug with large diameter end away from the connector, gently apply downward pressure to force the sealing plug into the cavity.



Step 2:

With perpendicular motion, apply downward pressure to the large diameter end of the sealing plug.

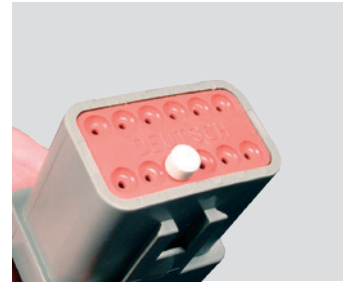

Step 3:

Apply pressure until sealing plug is forced to stop by contact with rear grommet. Visually inspect the sealing plug to confirm it is flush with cavity opening.

LOCKING SEALING PLUG INSTALLATION

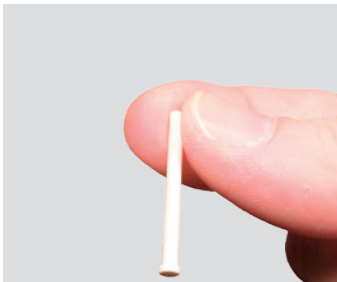

Step 1:

Holding the sealing plug with large diameter end towards the connector, gently apply downward pressure to force the sealing plug into the cavity.

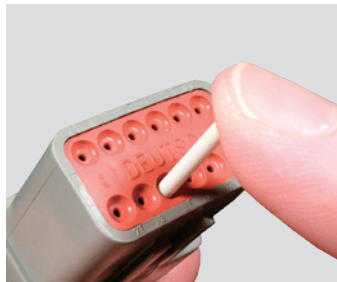

Step 2:

With perpendicular motion, apply downward pressure to the small diameter end of the sealing plug.



Step 3:

Apply pressure until sealing plug locks into place. A slight tug on the sealing plug will confirm it is locked into place.

CONTACT CRIMP SLEEVE REDUCER ASSEMBLY



Step 1:
Place crimp sleeve reducer into contact barrel.

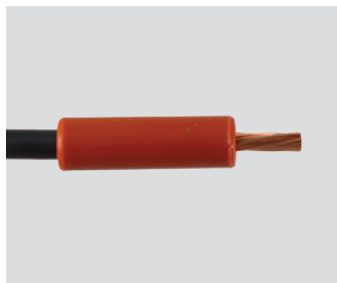

Step 2:
Slide insert seal onto 8-10 AWG wire stopping just at the edge of the stripped insulation.

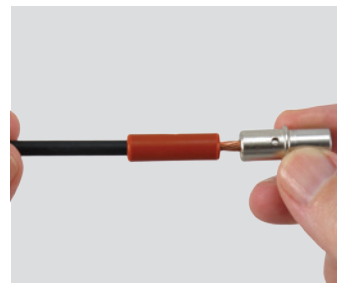

Step 3:
Insert wire into barrel of contact and crimp using designated tooling.



Step 4:
Confirm seal is not distorted.

Contents

Tooling Overview	182
Automated Tooling.....	182-184
Hand Tools	185-186
Removal Tools	187
How To Instructions	188-190

Crimp Tool Overview

The two types of DEUTSCH contacts are solid and stamped & formed. Both styles of contacts are designed for crimp style terminations - no solder is required or recommended. A crimp style termination displaces the wire strands creating a superior bond between the wire and the contact.

Several tools are available for hand and production wire crimping, wire insertion and removal, and wedgelock/terminal position assurance removal. The tools are specific to the solid contacts or the stamped & formed contacts. To create a proper crimp and achieve the highest performance specifications, contacts must be crimped with the recommended tooling.

Automated Tooling Overview

For higher production volumes, a pneumatic power crimp tool is available for the DEUTSCH solid contacts, and applicator dies for stamped & formed contacts. The HDP-400, a pneumatic solid crimp tool, is a fast, bench-top tool that crimps most DEUTSCH contacts. The HDP-400 has a foot control, and easy-to-change dies and locators for each contact size. TE's stamped & formed OCEAN applicator dies are heavy duty mini-dies that work in many industry standard presses. The OCEAN applicator dies offer simple adjustments and the flexibility to accept different sized contacts and wire gauge.

AUTOMATED TOOLING FOR SOLID CONTACTS



Tool Part Number	Contact Size	Contact Part Number
HDP-400	4	0460-204-0490
		0462-203-04141
	8	0460-204-08141
		0462-203-08141
	12	0460-204-12**
0462-203-12**		
16	0460-202-16**	
	0462-201-16**	
20	0460-215-16**	
	0462-209-16**	
20	0460-202-20**	
	0462-201-20**	

For the appropriate die and locator, see drawing 0425-205-0000

HDP-400 TOOLING ACCESSORIES

The Go-No-Go gauge is used to determine if the HDP-400 tool is calibrated within the recommended specifications to produce a proper crimp.



Part Number	Go-No-Go Gauges
GA20N	HDP-400 Size 20
450GA-16N	HDP-400 Size 16
450GA-12N	HDP-400 Size 12
GA8-SPEC	HDP-400 Size 8
450GA-4-SPEC	HDP-400 Size 4

AUTOMATED TOOLING FOR STAMPED & FORMED CONTACTS



	Pin P/N	Socket P/N	Insulation Range O.D. (mm)	Applicator P/N Conversion Kit P/N
Size 12 -Group 1	1060-12-0144 1060-12-0166	1062-12-0144 1062-12-0166	.151-.176 (3.83-4.47)	2266124-1 7-2266124-8
			.130-.154 (3.30-3.91)	2266125-1 7-2266125-8
			.113-.135 (2.87-3.43)	2266126-1 7-2266127-8
Size 12 -Group 2	1060-12-0222 1060-12-0244	1062-12-0222 1062-12-0244	.185-.204 (4.70-5.18)	2266127-1 7-2266127-8
			.155-.190 (3.94-4.83)	2266128-1 7-2266128-8
			.140-.160 (3.56-4.06)	2266129-1 7-2266129-8
Size 16 -Group 1	1060-14-0122 1060-14-0144 1060-14-0177	1062-14-0122 1062-14-0144 1062-14-0177	.120-.150 (3.05-3.81)	2266100-1 7-2266100-8
			1060-14-1077 1060-14-1088	1062-14-1077 1062-14-1088
Size 16 -Group 1	1060-16-0122 1060-16-0144 1060-16-0177	1062-16-0122 1062-16-0144 1062-16-0177	.105-.125 (2.67-3.18)	2266101-1 7-2266101-8
			.085-.111 (2.16-2.82)	2266102-1 7-2266102-8
	1060-16-0722 1060-16-0744 1060-16-0777	1062-16-0722 1062-16-0744 1062-16-0777	.075-.105 (1.91-2.67)	2266103-1 7-2266103-8
	1060-16-0977 1060-16-0988	1062-16-0977 1062-16-0988	.063-.094 (1.60-2.39)	2266104-1 7-2266104-8

The -1 suffix on the applicator p/n represents a mechanical feed, for other feed options contact your representative. The conversion kit is to convert applicators within the same group. For more information, please reference TE catalog 1-1773730-8 or contact your representative.

AUTOMATED TOOLING FOR STAMPED & FORMED CONTACTS (CONTINUED)

	Pin P/N	Socket P/N	Insulation Range O.D. (mm)	Applicator P/N Conversion Kit P/N
Size 16 -Group 2	1060-16-0622	1062-16-0622	.063-.094 (1.60-2.39)	2266110-1 7-2266110-8
	1060-16-0644	1062-16-0644		
	1060-16-0677	1062-16-0677	.050-.075 (1.27-1.91)	2266111-1 7-2266111-8
	1060-16-0688	1062-16-0688		
Size 16 -Group 3	1060-16-1222	1062-16-1222	.120-.140 (3.05-3.56)	2266112-1 7-2266112-8
	1060-16-1244	1062-16-1244	.105-.125 (2.67-3.18)	2266113-1 7-2266113-8
	1060-16-1277	1062-16-1277		
	-	1062-16-1422	.090-.110 (2.29-2.79)	2266114-1 7-2266114-8
	-	1062-16-1444		
	-	1062-16-1477	.075-.095 (1.91-2.41)	2266115-1 7-2266115-8
	-			
Size 20 -Group 1	1060-20-0122	1062-20-0122	.105-.125 (2.67-3.18)	2266116-1 7-2266116-8
	1060-20-0144	1062-20-0144		
	1060-20-0177	1062-20-0177	.085-.111 (2.16-2.82)	2266117-1 7-2266117-8
	-	1062-20-0322		
	-	1062-20-0344	.075-.105 (1.91-2.67)	2266118-1 7-2266118-8
	-	1062-20-0377		
	1060-20-0222	1062-20-0222	.063-.085 (1.62-2.16)	2266119-1 7-2266119-8
	1060-20-0244	1062-20-0244		
1060-20-0277	1062-20-0277	.050-.075 (1.27-1.91)	2266120-1 7-2266120-8	

The -1 suffix on the applicator p/n represents a mechanical feed, for other feed options contact your representative. The conversion kit is to convert applicators within the same group. For more information, please reference TE catalog 1-1773730-8 or contact your representative.

DEUTSCH Tooling

Hand Tool Overview

For field service, prototype, and low-volume production, there are several easy-to-use hand crimp tools for both solid barrel and stamped & formed contacts. All hand crimp tools provide a tight, complete crimp with minimal effort. The HDT-48-00, the most commonly used tool for solid contacts, crimps a wide range of contact sizes. It provides a symmetrical four indent crimp, is compact and easy-to-use for field service, yet sturdy and reliable enough for low volume production. Hand crimp tools for DEUTSCH stamped & formed contacts are wire gauge specific and simultaneously crimp the insulation and conductor, saving time and effort during field service.

HAND TOOLS FOR SOLID CONTACTS



HDT-04-08



HDT-48-00



HDT-50-00



HDT-1561

Contact Size	Contact Part Number	Tool Part Number	Crimp Type
4	0460-204-0490 0462-203-04141	HDT-04-08	Two indent crimp
8	0460-204-08141 0462-203-08141	HDT-04-08	Two indent crimp
12	0460-204-12** 0462-203-12**	HDT-48-00	Four indent crimp
		HDT-1561	Two indent crimp
		HDT-50-00	One indent crimp
16	0460-202-16** 0462-201-16** 0460-215-16** 0462-209-16**	HDT-48-00	Four indent crimp
		HDT-1561	Two indent crimp
		HDT-50-00	One indent crimp
20	0460-202-20** 0462-201-20**	HDT-48-00	Four indent crimp
		HDT-1561	Two indent crimp
		HDT-50-00	One indent crimp

HDT-48-00 TOOLING ACCESSORIES

Replacement parts, such as adjustment screws, locking nuts, and inspection tools are available for the HDT-48-00 hand tool.



Part Number	Crimp Tool Replacement Part
0426-209-0000	Adjustment screw and locking nut
M2700-395-10	Locking nut

helpful hint

Go-no-go gauges are used to inspect crimp tooling. The G454 gauge is used with the HDT-48-00 hand tool.



Part Number	Description
G454	HDT-48-00 Go-No-Go Gauge

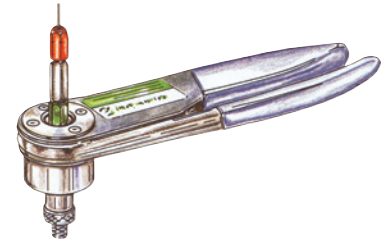

HAND TOOLS FOR DEUTSCH STAMPED & FORMED CONTACTS



DTT-12-00



DTT-12-01



DTT-16-00
DTT-16-01
DTT-20-00
DTT-20-02

Contact Size	Contact Part Number	Tool Part Number
12	1060-12-01** 1062-12-01**	DTT-12-00
	1060-12-02** 1062-12-02**	DTT-12-01
16	1060-16-01** 1062-16-01**	DTT-16-00 (14-16 AWG)
	1060-16-06** 1062-16-06**	DTT-16-01 (18 AWG)
20	1060-20-01** 1062-20-01**	DTT-20-00
	1060-20-02** 1062-20-02**	DTT-20-02

MULTI-USE REMOVAL TOOL



Part Number	Description
DT-RT1	Multi-use tool with a small hook on one end for wedgelock removal, and a small screwdriver on the other end to push back the locking fingers and release the contact. For use with the DT, DTM, DTP, DTV, DRB, and STRIKE series.

REMOVAL TOOLS

DEUTSCH removal tools are designed to simplify contact removal and field service repair in connectors that utilize a round shoulder contact retention system. Removal tools are compact, easy-to-use, and manufactured of heavy duty plastic to remove contacts without damage to the wire, insulation, connector seals, or connector body. The removal tools are required for wire removal in the DTHD, Jiffy Splices, HD10, HDP20, HD30, DRC, AEC, and WT series.



Part Number	Contact Size	Wire Gauge Range	Color
0411-027-0405	Size 4	4 AWG	Black
114009	Size 4	6 AWG	White
114008	Size 8	8-10 AWG	Green
0411-353-0805	Size 8 for HD Box	8-10 AWG	Green Extended
114010	Size 12	12 AWG	Yellow
0411-337-1205	Size 12	12-14 AWG Extra Thin Wall (E-Seal)	Orange
0411-291-1405	Size 16	14-16 AWG	Green
0411-310-1605	Size 16	16-20 AWG	Light Blue
0411-336-1605	Size 16	16-18 AWG Extra Thin Wall (E-Seal)	Dark Blue
0411-240-2005	Size 20	20-22 AWG	Red

helpful hint

A contact removal tool taped or tie wrapped to the harness will make it easily available, should repairs be needed.

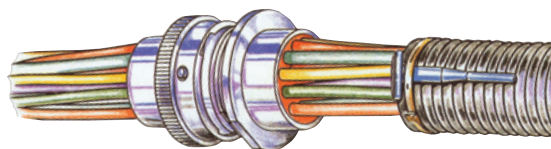

How To Instructions

WIRE STRIPPING

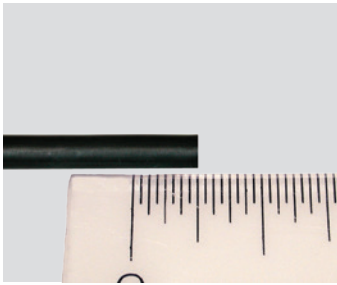

Step 1:

1. Choose the correct AWG for the contact being used.
2. Measure from the end of the wire the recommended strip length according to the contact size.
3. Place the wire into a stripping tool at the recommended strip length. Strip the wire according to stripping tool instructions.

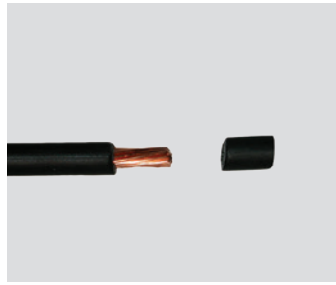

Step 2:

1. After stripping, a small piece of the insulation should come off.
2. Check for any broken strands or for a dent in the wire. If either exist, the wire is damaged and should be cut and stripped again.

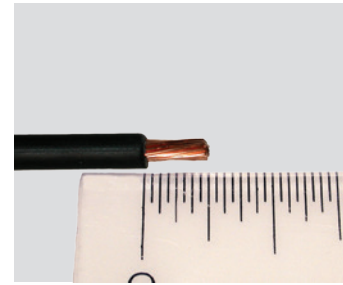

Step 3:

1. Measure the exposed strands to be sure the crimp length is correct.

helpful hint

Leaving the stripped portion of the insulation on the wire until crimping will avoid flayed wire strands.

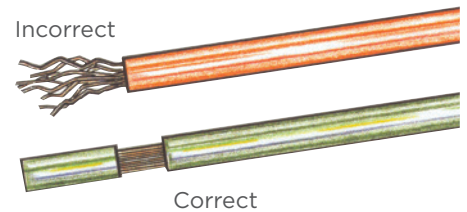

CRIMPING WITH THE HDT-48-00 HAND TOOL



Step 1:

1. Strip insulation from wire.
2. Raise selector knob and rotate until arrow is aligned with wire size to be crimped.
3. Loosen locknut, turn adjusting screw in until it stops.



Step 2:

1. Insert contact with barrel up. Turn adjusting screw counterclockwise until contact is flush with indenter cover. Tighten locknut.



Step 3:

1. Insert wire into contact. Contact must be centered between indentors. Close handles until crimp cycle is completed.
2. Release handles and remove crimped contact.

Note

Tool must be adjusted for each type/size of contact.

CRIMPING WITH DTT STYLE HAND TOOLS (SIZE 16 & 20)

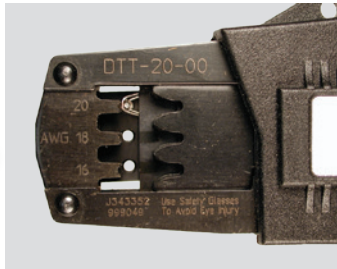

Step 1:
Cycle the hand tool to the open position. Place the contact into the correct die nest.

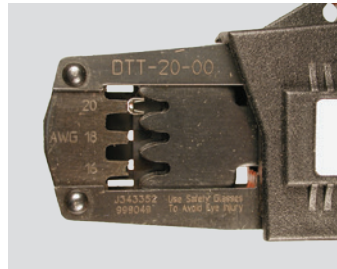

Step 2:
Partially close the tool until the contact is held in place.

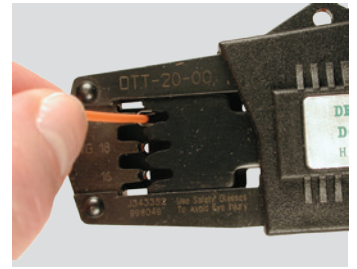

Step 3:
Insert the prestripped wire into the crimp area of the contact.

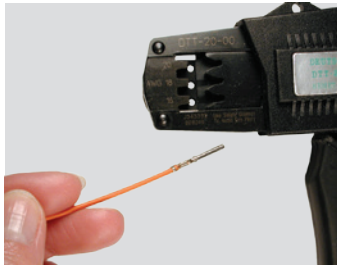

Step 4:
Close the tool until the ratchet releases. The ratchet is released when a loud click is heard and crimp is complete.

CRIMPING WITH DTT-12-01 HAND TOOL

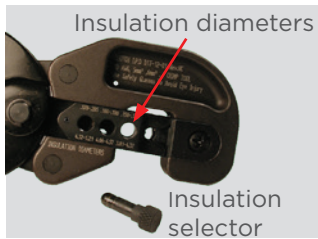

Step 1:
Cycle handles to release ratchet and fully open crimp jaws. Pull out insulation selector and push into proper diameter using the chart below.

Wire Type	Insulation Selector
10 TXL	.150-.170
10 GXL	.160-.180
10 SXL	.170-.205
5.0 mm ²	.160-.180
6.0 mm ²	.170-.205

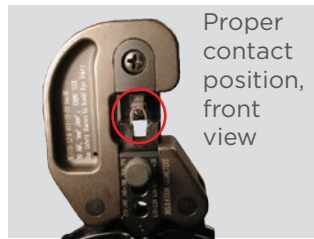

Step 2:
1. Insert contact into locator. Adjust alignment and width of crimp wings if necessary to help confirm capture by crimp jaws.
2. Insert stripped wire into the contact. Close crimp tool until full-cycle ratchet control releases.

Contents

Bussed Feedback Overview	192
Bussed Examples	192
Dimensions	193
Ordering Information.....	194

Bussing Options

Bussed Overview

DEUTSCH industrial bussed feedback receptacles are environmentally sealed connectors designed for use in heavy duty applications where multiple circuits require a common electrical pathway. Available in the DT Series, DEUTSCH bussed connectors feature integrated bussbars with standard DEUTSCH contacts.

A bussbar, or buss, is a thin conductive strip connecting two or more contacts within the body of a connector. Bussbars allow power or data to be fed into a connector through one or more terminals and drawn out as needed through the other contacts on the same buss. Connectors can carry one or more bussbars, creating multiple independent electrical circuits within the same connector body and distributing power or data to many components. A single bussed connector can replace several standard connectors or splices, saving space, wiring, and weight.

DT SERIES BUSSED FEEDBACK RECEPTACLES

DT bussed feedback receptacles are a compact economical bussing option housed in rugged, field-proven DT receptacle bodies. The bussed DTs mate with standard DT plugs and meet all the performance specifications for the DT series. The connectors are available in multiple buss configurations using standard size 16 contacts, with plating options in nickel or gold.

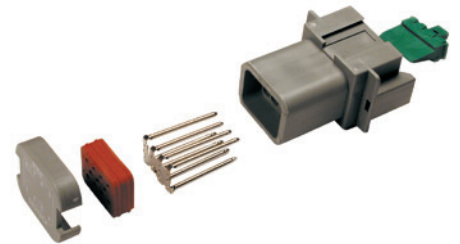

BUSSED EXAMPLES

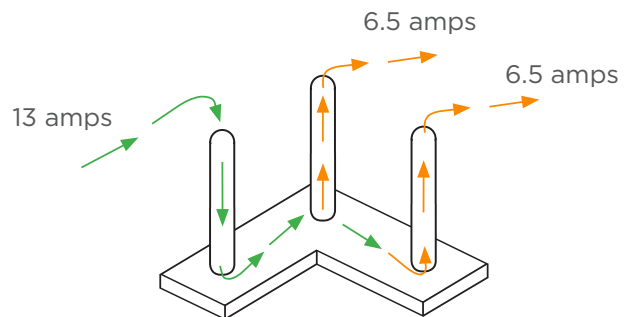
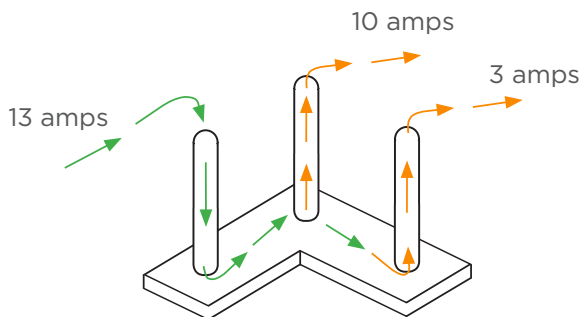

In the examples, there are three size 16 pins each rated for 13 amps mounted to the buss. A total of 13 amps can be pulled into one pin and going out the 13 amps are split between the remaining two pins. No more than 13 amps can go through any single pin.

Note

The maximum current rating is the total amount of current for the entire buss. Current can be distributed in many combinations, but cannot exceed 13 amps per contact.

Bussing Options

DIMENSIONS

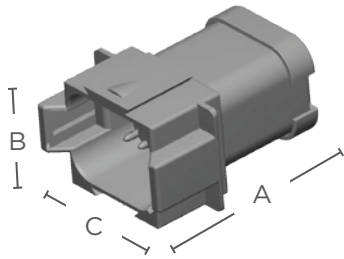

DT Receptacle

Cavity	Overall Length A	Overall Height B	Overall Width C
2	1.818 (46.18)	.670 (17.15)	.675 (17.15)
4	1.868 (47.45)	.797 (20.24)	.820 (20.83)
6	1.858 (47.19)	.972 (24.69)	.820 (20.83)
8	1.848 (46.94)	1.000 (25.40)	1.435 (36.45)
12	2.043 (51.89)	.876 (22.25)	1.597 (40.56)





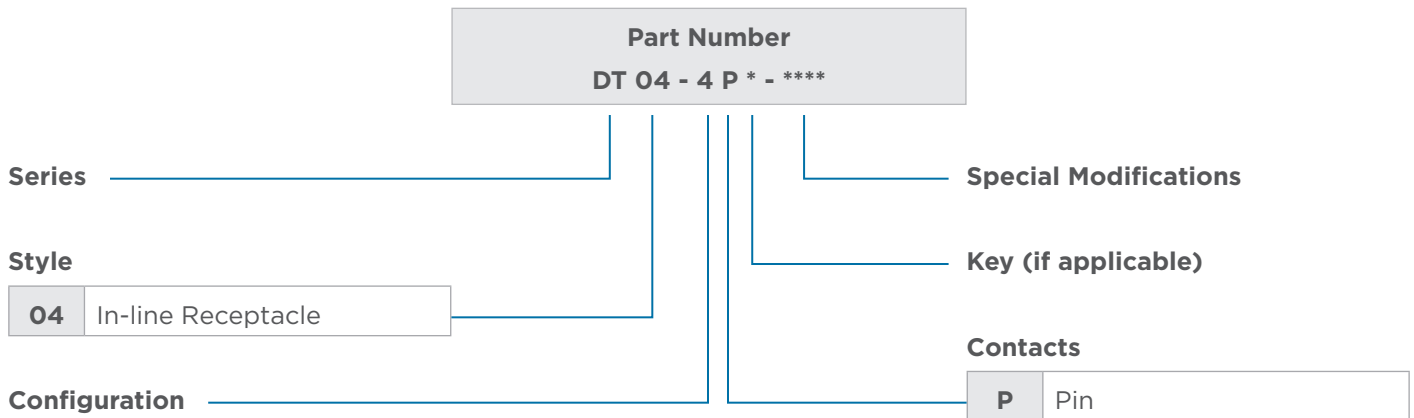





Dimensions are for reference only.

DT SERIES BUSSED FEEDBACK RECEPTACLE PART NUMBERING SYSTEM



Bussing Options

ORDERING INFORMATION

Bussing Arrangements	Maximum Current Rating*	Buss Plating	Connector Color	Receptacle Part Number	Mating Plug Part Number
 (1) 2	(1) 2 Pin Buss=13 amps	Nickel	Black	DT04-2P-P060	DT06-2S-****
 (1) 4	(1) 4 Pin Buss=26 amps	Nickel Nickel	Black Gray	DT04-4P-EP13 DT04-4P-P021	DT06-4S-**** DT06-4S-****
 (1) 6	(1) 6 Pin Buss=39 amps	Nickel Nickel	Black Gray	DT04-6P-EP13 DT04-6P-P021	DT06-6S-**** DT06-6S-****
 (2) 3's	(2) 3 Pin Busses=13 amps each	Nickel	Black	DT04-6P-EP14	DT06-6S-****
 (1) 8	(1) 8 Pin Buss=52 amps	Nickel Nickel	Gray Black	DT04-08PA-P021 DT04-08PB-P021	DT06-08SA-**** DT06-08SB-****
 (1) 3, (1) 5	(1) 3 Pin Buss=13 amps (1) 5 Pin Buss=26 amps	Nickel Nickel	Gray Black	DT04-08PA-P028 DT04-08PB-P028	DT06-08SA-**** DT06-08SB-****
 (2) 4's	(2) 4 Pin Busses=26 amps each	Nickel Nickel	Gray Black	DT04-08PA-P026 DT04-08PB-P026	DT06-08SA-**** DT06-08SB-****
 (1) 12	(1) 12 Pin Buss=78 amps	Gold Gold Nickel Nickel	Gray Black Gray Black	DT04-12PA-P016 DT04-12PB-P016 DT04-12PA-P021 DT04-12PB-P021	DT06-12SA-**** DT06-12SB-**** DT06-12SA-**** DT06-12SB-****
 (2) 6's	(2) 6 Pin Busses=39 amps each	Nickel Nickel Gold	Gray Black Black	DT04-12PA-P026 DT04-12PB-P026 DT04-12PB-P027	DT06-12SA-**** DT06-12SB-**** DT06-12SB-****
 (3) 4's	(3) 4 Pin Busses=26 amps each	Nickel	Gray	DT04-12PA-P075	DT06-12SA-****
 (4) 3's	(4) 3 Pin Busses=13 amps each	Nickel Nickel Gold Gold	Gray Black Gray Black	DT04-12PA-P030 DT04-12PB-P030 DT04-12PA-P031 DT04-12PB-P031	DT06-12SA-**** DT06-12SB-**** DT06-12SA-**** DT06-12SB-****

*Maximum current rating is the total amperage for the buss

Contents

Controller Area Networks (CAN)	
Overview	196
ISO Box	196
J1939/11 9-pin Diagnostic.....	198-199
J1939/13 Connector Options	200-201
J1939/15 Connector Options	202-203

CAN Overview

Controller Area Networks, or CAN, are multiplex data systems. Multiplexing allows multiple data signals to travel on the same wires, integrating separate electronic systems and applications to a single point control and monitoring system. Using signals sent over a serial network, CAN systems provide instantaneous monitoring of diagnostic and control systems allowing early detection of potential problems. Early detection of problems leads to lower repair costs and reduced downtime. CAN systems allow an operator to use a single command station to control diagnostic systems and receive such varied information as brake and transmission temperature, tire pressure, fuel efficiency, and emissions levels. Anything that can be measured and controlled electronically can be monitored and directed by a CAN system.

ISO/CD 11783-2 ISO BOX AND ASSOCIATED CONNECTORS

Originally designed for agricultural applications, the DEUTSCH ISO Box creates a communication pathway between an on-board CAN system and the electronic components on an attached implement. The HDBox, which holds two DT13 connectors and an HD30 series receptacle, mounts on the vehicle and mates with an HD30 plug connector that features a breakaway coupling ring. DEUTSCH breakaway couplings are designed to help prevent damage to the vehicle or the attached implement by fragmenting and separating from the vehicle in the event of a drive-away disconnect.



Part Number	Description
HDBOX-24-91PN	ISO Box assembly
HDBOX-24-91PE	ISO Box assembly, reduced wire seal
HD36-24-91SN-059	Plug, cable clamp assembly
HD36-24-91SE-059	Plug, cable clamp assembly, reduced wire seal
HDB36-24-91SN-059	Plug, breakaway coupling, cable clamp assembly
HDB36-24-91SE-059	Plug, breakaway coupling, cable clamp assembly, reduced wire seal
DT06-4S-EP06*	Plug, black, end cap
DT06-2S-EP06*	Plug, black, end cap
W4S-P012	Wedgelock, green
W2S-P012	Wedgelock, green
0460-204-08141	Pin, solid, size 8
0460-204-12141	Pin, solid, size 12
0460-202-1631	Pin, solid, size 16, gold
0462-203-08141	Socket, solid, size 8
0462-203-12141	Socket, solid, size 12
0462-201-1631	Socket, solid, size 16, gold

*DT series receptacles are molded in the HDBox

Controller Area Networks

CAN PRODUCT OPTIONS

Whether you're building a Controller Area Network for anything from on/off-highway, construction, material handling, agriculture machines, to your OEM fleet of fire engines, there is a DEUTSCH solution for your CAN needs. Options include several configurations: 2-wire, 3-wire, and 4-wire, with in-line and flange mount, along with splitters, heavy duty breakaway connectors, and an off-board 9-pin diagnostic connector.

SAE J1939 is a specific type of CAN that defines the communications pathways for vehicle networks. Improved electrical systems as defined under SAE J1939 allow electrical devices to communicate with each other. Communication occurs using a Controlled Area Network between intelligent sensors over a serial network. Through a series of microprocessors a CAN interconnects every device establishing a common link between each.

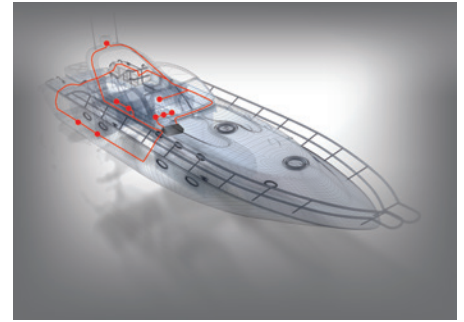

There are three main electrical interconnect subsets of J1939 including /11, /13, and /15:

- J1939/11 is a 3-wire system that uses the DEUTSCH DT series connectors primarily for truck and bus. The DT series accepts size 16 contacts and 14-20 AWG. Connector options include in-line, bulkhead, "Y" splitter, and terminating resistors.
- J1939/13 is a system that uses the DEUTSCH HD10 series connectors for on-board diagnostics. The HD10 series accepts size 16 contacts and 14-20 AWG.
- J1939/15 is a 2-wire system that uses the DEUTSCH DTM series connectors. The DTM series accepts size 20 contacts and 16-22 AWG. Connector options include in-line, "Y" splitter, and terminating resistors.

The sophistication of equipment design is demanding increased response of electrical systems. The application of J1939 allows designers to improve the quantity and the quality of the options offered along with increased electrical system reliability.

Controller Area Networks

J1939/11 3 WIRE SYSTEM SCHEMATIC

DEUTSCH J1939/11 connectors are rugged field proven DT 3 pin connectors designed to meet the SAE requirements for 3-wire CAN applications linking ECUs for serial data communications. The DT 3 way connectors accommodate the CAN_HI, CAN_LO and shield wires with a variety of options including “Y” receptacles, connectors with mounting flanges, keyed wedgelocks to prevent mis-mating, and network terminating connectors with molded-in 120Ω resistors.

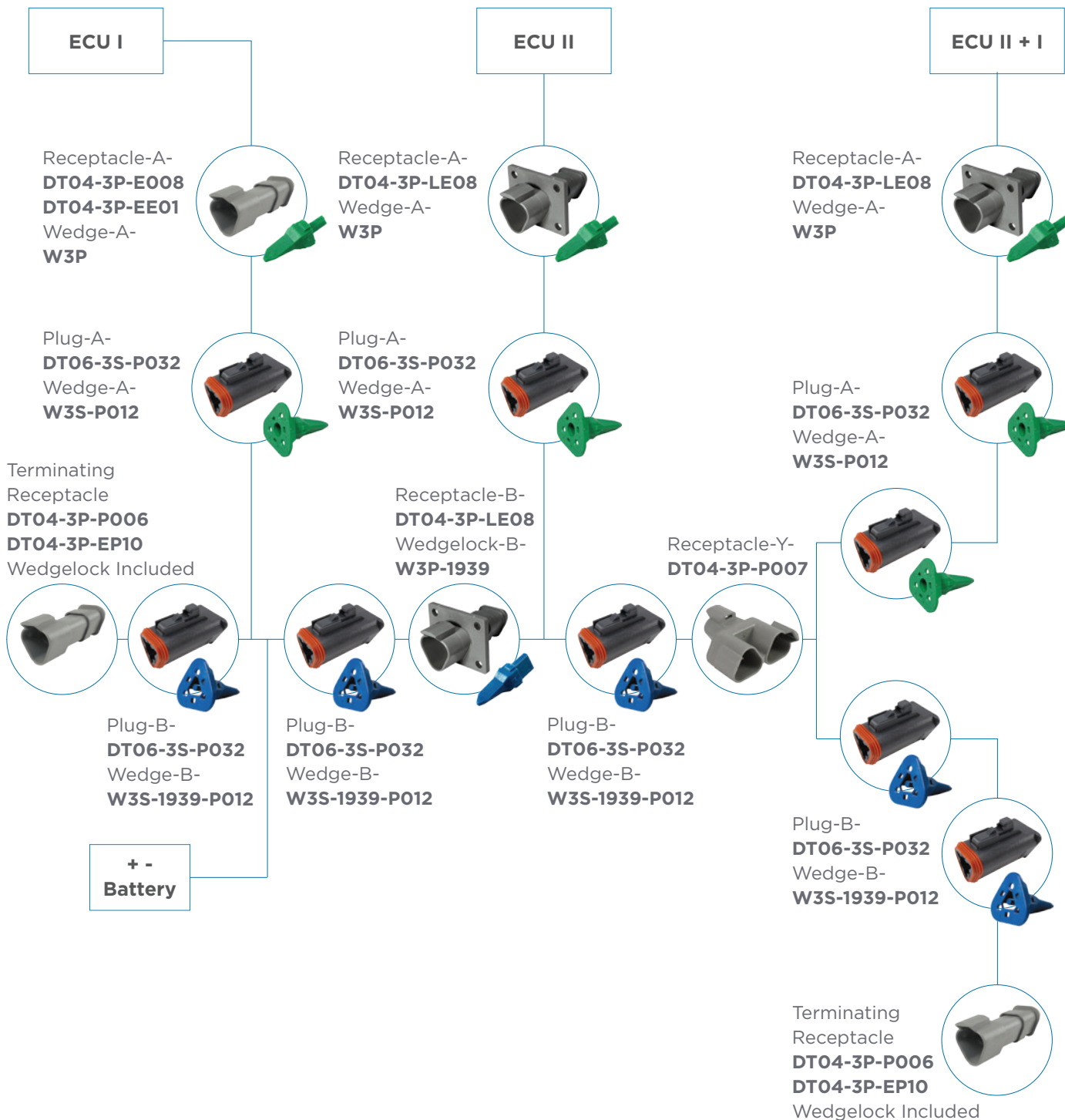

J1939/11 DEUTSCH CONNECTOR OPTIONS

Part Number	Description
DT04-3P-P007	Receptacle, “y” connector
DT04-3P-E008	Receptacle, gray, shrink boot adapter
DT04-3P-P006	Receptacle, gray, 120Ω resistor
DT04-3P-EE01	Receptacle, black, shrink boot adapter
DT04-3P-EP10	Receptacle, black, 120Ω resistor
DT06-3S-E008	Plug, gray, shrink boot adapter
DT06-3S-P006	Plug, gray, 120Ω resistor
DT06-3S-EP11	Plug, black, shrink boot adapter
DT06-3S-PP01	Plug, black, 120Ω resistor
DT06-3S-PE01	Plug, black, 120Ω resistor, latch guard
DT06-3S-P032	Plug, black, single piece shrink boot adapter
W3P-1939	Wedglock, blue
W3S	Wedglock, orange
W3S-P012	Wedglock, green
W3S-1939	Wedglock, blue
W3S-1939-P012	Wedglock, blue
0460-202-1631	Pin, solid, size 16, gold
1060-16-0144	Pin, stamped & formed, size 16, gold
0460-247-1631	Pin, solid, size 16, gold, extended
0462-201-1631	Socket, solid, size 16, gold
1062-16-0144	Socket, stamped & formed, size 16, gold
0462-221-1631	Socket, solid, size 16, gold, extended



J1939/13 UNIVERSAL 9-PIN DIAGNOSTIC

DEUTSCH J1939/13, HD10 9 pin connector is a standard diagnostic tool interface for on- and off-highway OEMs. The HD10-9-1939P is a data port connector designed to allow an on-board CAN system to mate with a diagnostic computer. The connectors are for use with the 250 kbps network. The DEUTSCH HD10 J1939/13 connectors offer several mounting options for the receptacle, and a mating plug that is available with or without a coupling ring.



Part Number	Description
HD10-9-1939P	Receptacle
HD10-9-1939P-B022	Receptacle, panel nut mount
HD10-9-1939PE-B022	Receptacle, panel nut mount, reduced wire seal
HD10-9-1939PE	Receptacle, reduced wire seal
HD16-9-1939S	Plug, coupling ring
HD16-9-1939SE	Plug, coupling ring, reduced wire seal
HD17-9-1939S	Plug, no coupling ring (slip-on)
HD17-9-1939SE	Plug, no coupling ring (slip-on), reduced wire seal
0460-202-1631	Pin, solid, size 16, gold
0460-247-1631	Pin, solid, size 16, gold, extended
0462-201-1631	Socket, solid, size 16, gold
0462-221-1631	Socket, solid, size 16, gold, extended

Controller Area Networks

J1939/13 TYPE II UNIVERSAL 9-PIN DIAGNOSTIC

DEUTSCH J1939/13, HD10 9 pin connector is a standard diagnostic tool interface for on- and off-highway OEMs. The HD10-9-1939P*-P080 is a data port connector designed to allow an on-board CAN system to mate with a diagnostic computer. The green, Type II connectors, HD10-9-1939P-P080, are for use with the 500 kbps network. The DEUTSCH HD10 J1939/13 connectors offer several mounting options for the receptacle, and a mating plug that is available with or without a coupling ring.

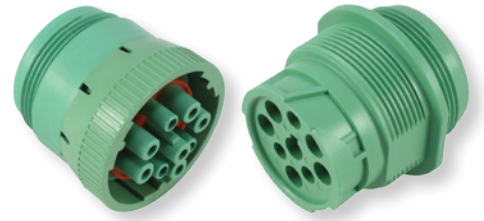

Part Number	Description
HD10-9-1939P-P080	Receptacle, flange mount, type II
HD10-9-1939PE-P080	Receptacle, flange mount, type II, reduced wire seal
HD10-9-1939P-BP03	Receptacle, panel nut mount, type II
HD10-9-1939PE-BP03	Receptacle, panel nut mount, type II, reduced wire seal
HD14-9-1939P-P080	Receptacle, type II
HD14-9-1939PE-P080	Receptacle, type II, reduced wire seal
HD16-9-1939S-P080	Plug, coupling ring, type II
HD16-9-1939SE-P080	Plug, coupling ring, type II, reduced wire seal
HD17-9-1939S-P080	Plug, no coupling ring (slip-on), type II
HD17-9-1939SE-P080	Plug, no coupling ring (slip-on), type II, reduced wire seal
0460-202-1631	Pin, solid, size 16, gold
0460-247-1631	Pin, solid, size 16, gold, extended
0462-201-1631	Socket, solid, size 16, gold
0462-221-1631	Socket, solid, size 16, gold, extended

Controller Area Networks

J1939/15 2 WIRE SYSTEM SCHEMATIC

SAE J1939/15 defines the requirements for reduced physical layer 2-wire CAN systems consisting of an unshielded twisted pair of wires. DEUTSCH DTM 2 way connectors are offered in several modifications to meet the requirements of this standard. DTM connectors for serial data communications include “Y” receptacles, connectors with end caps and shrink boot adapters, and receptacles with molded-in 120Ω resistors for network terminations.

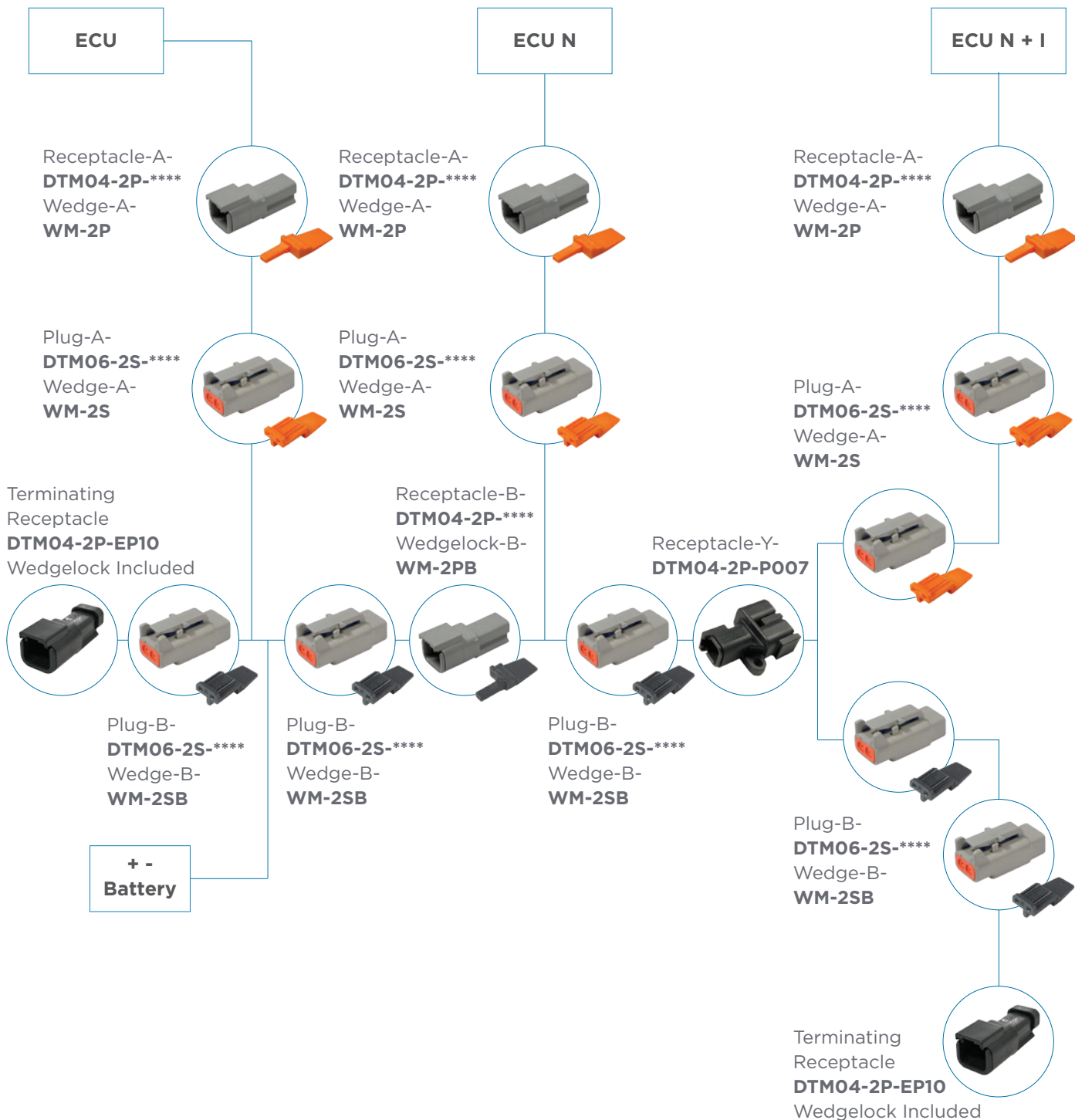

J1939/15 DEUTSCH CONNECTOR OPTIONS

Part Number	Description
DTM04-2P-P007	Receptacle, "y" connector
DTM04-2P-E007	Receptacle, gray, shrink boot adapter
DTM04-2P-P006	Receptacle, gray, 120Ω resistor
DTM04-2P-EE03	Receptacle, black, shrink boot adapter
DTM06-2S-E007	Plug, gray, shrink boot adapter
DTM06-2S-P006	Plug, gray, 120Ω resistor
DTM06-2S-EE03	Plug, black, shrink boot adapter
DTM06-2S-EP10	Plug, black, 120Ω resistor
WM-2P	Wedglock, orange
WM-2PA	Wedglock, gray
WM-2PB	Wedglock, black
WM-2S	Wedglock, orange
WM-2SA	Wedglock, gray
WM-2SB	Wedglock, black
0460-202-2031	Pin, solid, size 20, gold
1060-20-0144	Pin, stamped & formed, size 20, gold
0462-201-2031	Socket, solid, size 20, gold
1062-20-0144	Socket, stamped & formed, size 20, gold



NOTES:

Contents

Diodes & Resistors Overview.....	206
Configurations.....	206
Diodes & Resistor Characteristics.....	207-208

Diodes & Resistors Overview

DEUTSCH DT connectors with diodes and resistors are useful anywhere you need to regulate power or protect a device against a potential power surge.

A diode allows current to flow in one direction only. By preventing current from traveling a circuit in the wrong direction, a diode can protect an electronic device from damage. Devices with batteries will often use diodes to prevent power from flowing in reverse if the battery is not installed correctly.

A resistor limits or blocks current flow in both directions. Resistors protect sensitive electronics by limiting the amount of electricity that can flow to the device through the resistor, and therefore preventing power spikes. For example, resistors are used to prevent power surges from burning out an LED by restricting current flow to the light.

DEUTSCH diode and resistor connectors are easily added to an application after the fact if unwanted power surges are discovered.

DIODE & RESISTOR CONFIGURATIONS

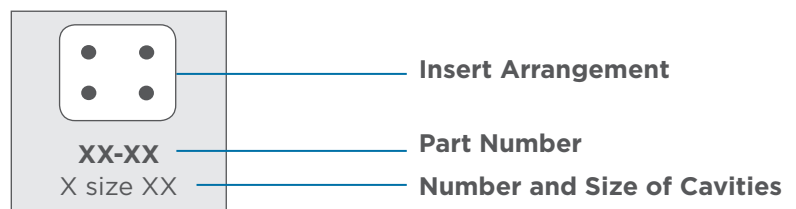

DT SERIES CONFIGURATIONS



DT0*-2*-****
2 size 16



DT0*-3*-****
3 size 16

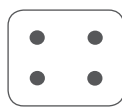

DT0*-4*-****
4 size 16

DTM SERIES CONFIGURATIONS



DTM0*-2*-****
2 size 20



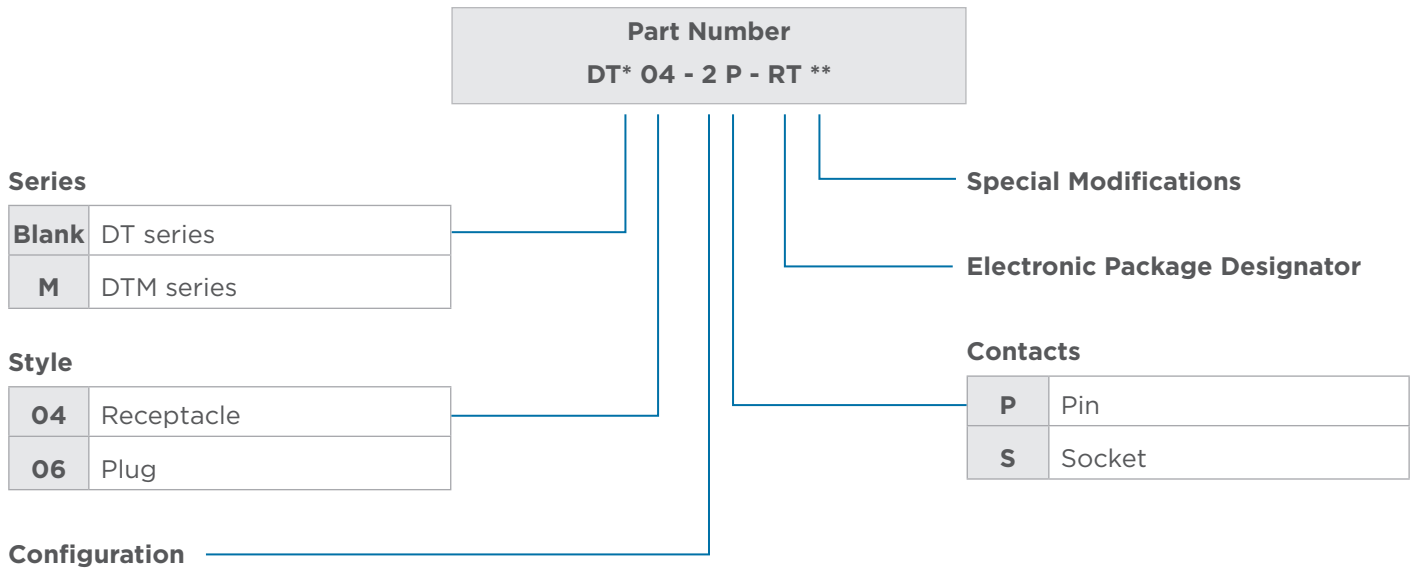

PART NUMBERING SYSTEM







DIODE CHARACTERISTICS

DT Series	Part Number	Plug or Receptacle	Diode Part Number	Peak Reverse Volts	Peak Forward Volts	Avg. Forward Current	Color
	DT04-2P-RT01	Receptacle	MUR460	600 V max.	1.28 V max.	4.0 A max.	Black
	DT04-2P-RT02	Receptacle	1N5625GP	400 V max.	1.0 V max.	3.0 A max.	Black
	DT04-4P-RT01	Receptacle	MUR460 (3)	600 V max.	1.28 V max.	4.0 A max.	Black
	DT04-4P-RT03	Receptacle	MUR460 (2)	600 V max.	1.28 V max.	4.0 A max.	Gray

RESISTOR CHARACTERISTICS

DTM Series	Part Number	Plug or Receptacle	Resistor Ohms	Resistor Watts	Color
	DTM04-2P-EP10	Receptacle	120	0.4	Black (B keyed wedgelock included)
	DTM04-2P-P006	Receptacle	120	0.4	Gray (A keyed wedgelock included)
	DTM06-2S-EP10	Plug	120	0.4	Black (B keyed wedgelock included)
	DTM06-2S-P006	Plug	120	0.4	Gray (A keyed wedgelock included)

DT Series	Part Number	Plug or Receptacle	Resistor Ohms	Resistor Watts	Color
	DT04-2P-RT25	Receptacle	27k	0.5	Black
	DT04-3P-EP10	Receptacle	120	0.4 min.	Black (J1939 keyed wedgelock included)
	DT04-3P-P006	Receptacle	120	0.4 min.	Gray (J1939 keyed wedgelock included)
	DT06-3S-EP10	Plug	120	0.4 min.	Black (J1939 keyed wedgelock included)
	DT06-3S-P006	Plug	120	0.4 min.	Gray (J1939 keyed wedgelock included)

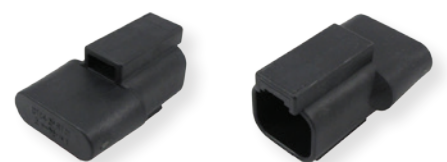

Contents

Printed Circuit Board Overview	210
PCB Connector Options	210
AMPSEAL Connectors	211
Circular DIN Connectors	211
DRC Series	212-213
DT Family	214-216
HD10 Series	216
LEAVYSEAL	217
STRIKE Series	217
Superseal 1.0 Connectors	218
PCB Enclosures and Headers	218-221

Printed Circuit Board Connectors

Printed Circuit Board Overview

Printed circuit board or PCB connectors are heavy duty environmentally sealed connectors designed for wire-to-circuit board connections. TE Connectivity Industrial & Commercial Transportation's connectors are built to maintain the integrity and continuity of data and power signals in harsh environments. Developed and designed for heavy duty electronically equipped vehicles, TE's printed circuit board connector bodies will withstand dust, dirt, moisture, and vibration.

Available in a variety of styles from several different connector families, TE's printed circuit board connectors cover a range of pin counts from 2 to 76 and wire gauges from 10 to 22. Many of the connectors are available in straight, 90°, or solder pot options.

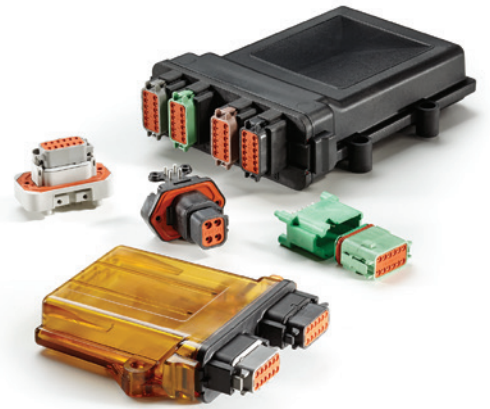

PRINTED CIRCUIT BOARD CONNECTOR OPTIONS

Product Line	Cavity Arrangements	Mating Connector Wire Size
AMPSEAL	8, 14, 23, 35	16-20 AWG
Circular DIN	2, 3, 4	2.50-.20 mm ²
DRC Series	24, 40, 50, 60, 70, 76	14-22 AWG
DT Series	2, 3, 4, 6, 8, 12	14-20 AWG
DTM Series	8, 12, 48 (flangeless)	16-22 AWG
DTP Series	4	10-14 AWG
HD10 Series	6,9	14-20 AWG
LEAVYSEAL	21, 39, 62, 92	6.0-.20 mm ²
STRIKE	32	14-22 AWG
Superseal 1.0	26, 34, 60	1.25-.50 mm ²
EEC Enclosure and Flange Receptacle	12, 24, 36, 48 (DT series headers)	14-20 AWG
	12, 24 (DTM series headers)	16-22 AWG

Notes: DT series has flangeless options. Some arrangements of the DT and DTM series are available with A, B, C, and D keying options.

Note

See individual product line sections for part numbering system.

Printed Circuit Board Connectors

AMPSEAL CONNECTORS 90° OR STRAIGHT

Materials

Cover: Glass filled PBT
Wire Seal: Silicone rubber
Contacts: Tin or gold plated brass

Mating Plugs

8 Position: 776286-
14 Position: 776273-
23 Position: 770680-
35 Position: 776164-

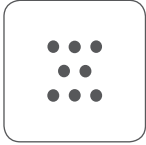

8 Positions
8 size 1.3 mm

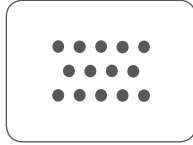

14 Positions
14 size 1.3 mm

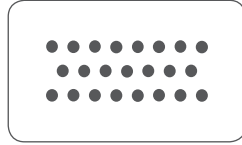

23 Positions
23 size 1.3 mm

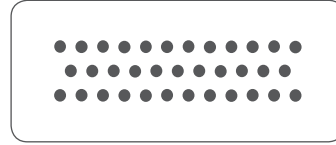

35 Positions
35 size 1.3 mm

Note

See pages 11-20 for comprehensive AMPSEAL product information.

CIRCULAR DIN CONNECTORS STRAIGHT

Materials

Housing: Glass filled PBT & PA
Flange Seal: Silicone rubber
Contacts: CuZn, tin plated
CuZn, gold plated

Mating Plugs

2 Position: 1-967325-3, 1-968968-3 (secondary locking)
3 Position: 1-967325-2, 1-968968-2 (secondary locking)
4 Position: 1-967325-1, 1-968968-1 (secondary locking)



2 Positions
2 size 2.5 mm



3 Positions
3 size 2.5 mm

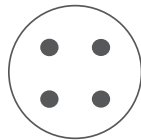

4 Positions
4 size 2.5 mm

Note

See pages 35-44 for comprehensive Circular DIN product information.

DRC10 SERIES STRAIGHT

Materials

Housing: Glass filled PA and PPS
Grommet: Silicone rubber
Receptacle Threaded Insert:
Stainless steel/brass
Contacts: Molded-in copper alloy,
tin plated solder pot standard
(gold optional - see
modifications)

Mating Plugs

24 Pin: DRC16-24S*
40 Pin: DRC16-40S

Modifications

A004: Tin plated PCB pins
AG02: Some terminals
are gold plated

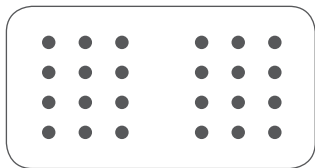

DRC10-24P*
24 size 16

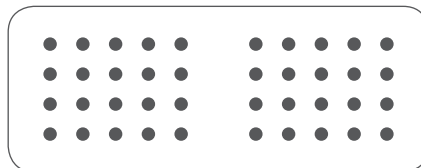

DRC10-40P*
40 size 16

DRC13 SERIES 90°

Materials

Housing: Glass filled PA and PPS
Receptacle Threaded Insert:
Stainless steel/brass
Contacts: Molded-in copper alloy,
tin plated PCB pins standard (gold
optional - see modifications)
Mounting Seal: Silicone rubber

Mating Plugs

24 Pin: DRC16-24S*
40 Pin: DRC18-40S*
70 Pin: DRC16-70S*

Modifications

C023: 5mm² threaded insert
mounting holes
G002: Only outside terminal rows
are gold plated
N012: One piece connector design

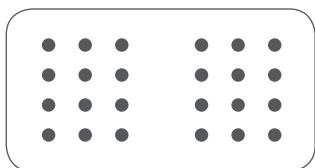

DRC13-24P*
24 size 16

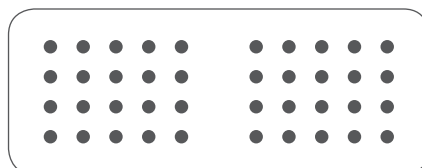

DRC13-40P*
40 size 16

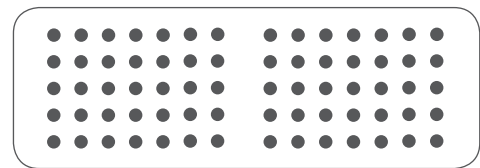

DRC13-70P*
70 size 16

Printed Circuit Board Connectors

DRC20/22 SERIES STRAIGHT

Materials

Housing: Glass filled PA and PPS
 Grommet: Silicone rubber
 Receptacle Threaded Insert:
 Stainless steel/brass
 Contacts: Molded-in copper alloy,
 gold plated mating side, tin plated
 PCB side (size 12 contacts are tin
 plated on mating and PCB sides)
 Mounting Seal: Silicone rubber

Mating Plugs

50 Pin: DRC26-50S**
 60 Pin: DRC26-60S**
 76 Pin: (2) DRC26-38S**

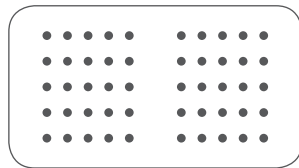

DRC2*-50P*
50 size 20

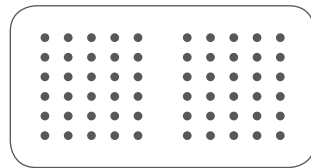

DRC20-60P*
60 size 20

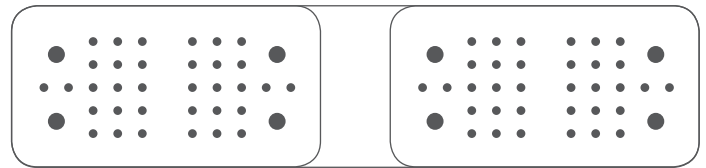

DRC20-76P****
68 size 20, 8 size 12

DRC23 SERIES 90°

Materials

Housing: Glass filled PA and PPS
 Grommet: Silicone rubber
 Receptacle Threaded Insert:
 Stainless steel/brass
 Contacts: Molded-in copper alloy,
 gold plated PCB pins standard
 (tin optional)
 Mounting Seal: Silicone rubber

Mating Plugs

24 Pin: DRC26-24S*
 40 Pin: DRC26-40S*
 64 Pin: DRC26-24S*, DRC26-40S*

Modifications

N010: Custom mount
 N012: One piece connector design

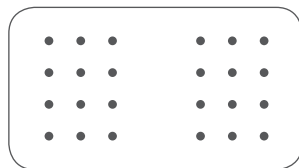

DRC2*-24**
24 size 20

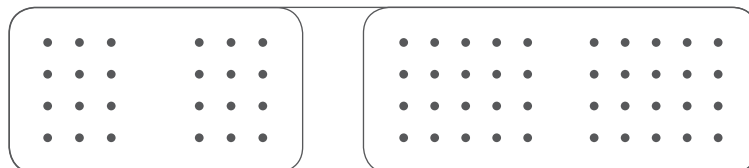

DRC2*-64**
64 size 20

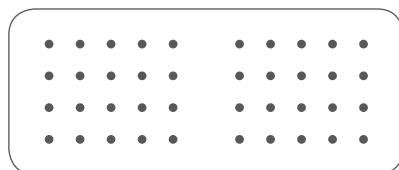

DRC2*-40**
40 size 20

Note

See pages 99-108 for comprehensive
 DRC series product information.

Printed Circuit Board Connectors

DT13/15 SERIES 90° OR STRAIGHT

Materials

Housing: Glass filled PA
 Contacts: Molded-in copper alloy, nickel plated mating side, tin plated PCB side (gold plating optional - contact your representative)
 Mounting Seal: Silicone rubber

Mating Plugs

2 Pin: DT06-2S
 3 Pin: DT06-3S
 4 Pin: DT06-4S
 6 Pin: DT06-6S
 8 Pin: DT06-08S*
 12 Pin: DT06-12S*

Modifications

B016: Extended shell and additional keys
 G003: Gold plated pins

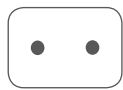
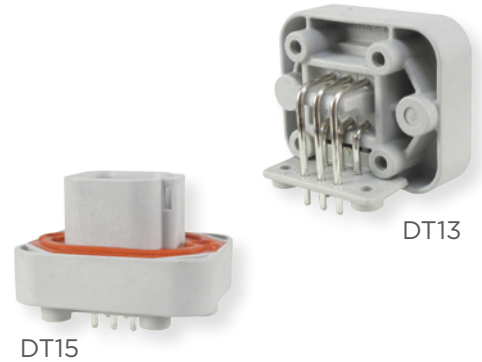

DT1*-2P
2 size 16



DT1*-4P
4 size 16

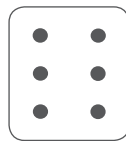

DT1*-6P
6 size 16

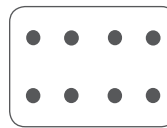

DT1*-08P*
8 size 16
A, B, C, D

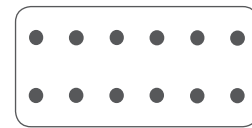

DT1*-12P*
12 size 16
A, B, C, D

Note

Camcar thread forming screws are recommended. See drawing.

DTF13 SERIES FLANGELESS 90°

Materials

Housing: Glass filled PA
 Contacts: Molded-in copper alloy, tin plated PCB side (gold plating optional - contact your representative)

Mating Plugs

2 Pin: DT06-2S
 3 Pin: DT06-3S
 4 Pin: DT06-4S
 6 Pin: DT06-6S
 12 Pin: DT06-12S*

Modifications

G003: Gold plated pins



DTF13-2P
2 size 16



DTF13-3P
3 size 16



DTF13-4P
4 size 16

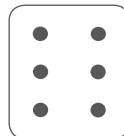

DTF13-6P
6 size 16

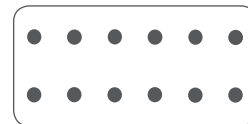

DTF13-12P*
12 size 16
A, B, C, D

Printed Circuit Board Connectors

DTF15 SERIES FLANGELESS STRAIGHT

Materials

Housing: Glass filled PA
Contacts: Molded-in copper alloy, tin plated PCB side (gold plating optional - contact your representative)

Mating Plugs

12 Pin: DT06-12S*

Modifications

G003: Gold plated pins

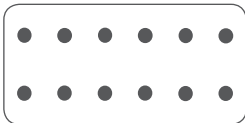
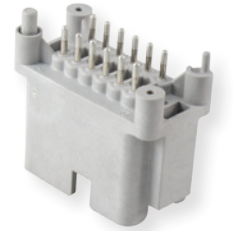

DTF15-12P*

12 size 16

A, B, C, D

helpful hint

By fixing the connectors to the board prior to soldering, pressure can be greatly reduced at the solder joint.

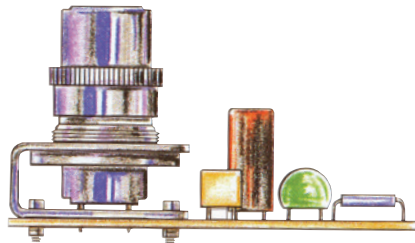

DTM13/15 SERIES 90° OR STRAIGHT

Materials

Housing: Glass filled PA
Contacts: Molded-in copper alloy, tin plated PCB side (gold plating optional - contact your representative)
Mounting Seal: Silicone rubber

Mating Plugs

12 Pin: DTM06-12S*

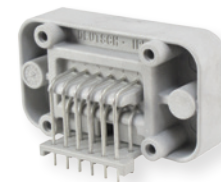

DTM13



DTM15

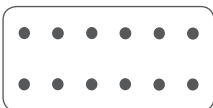

DTM1*-12P*

12 size 20

A, B, C, D

Note

See pages 109-132 for comprehensive DT Family product information.

Printed Circuit Board Connectors

DTMF15 SERIES STRAIGHT

Materials

Housing: Glass filled PA
Contacts: Molded-in copper alloy, tin plated (gold plating optional - contact your representative)

Mating Plugs

12 Pin: (4) DTM06-12S*

Modifications

B026: Alternate keying position

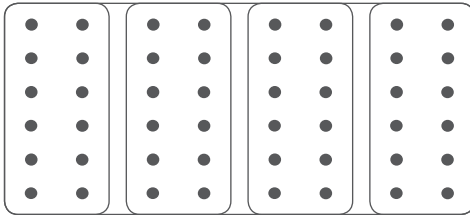

DTMF15-48P
(4) 12 size 20

DTP10/13/15 SERIES 90° OR STRAIGHT

Materials

Housing: Glass filled PA
Contacts: Molded-in copper alloy, tin plated
Mounting Seal: Silicone rubber

Mating Plugs

4 Pin: (4) DTP06-4S

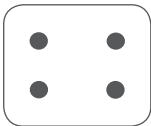

DTP1*-4P
4 size 12



DTP10

DTP13

HD10 SERIES STRAIGHT

Materials

Housing: Glass filled PA
Contacts: Molded-in copper alloy, nickel plated
Mounting Seal: Standard
o-rings may be used

Mating Plugs

6 Pin: HD16-6-96S
9 Pin: HD16-9-96S

Modifications

N005: Straight reduced diameter pins supplied as standard

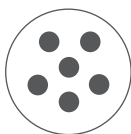

HD10-6-96P-N005
6 size 16

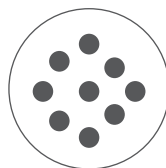

HD10-9-96P-N005
9 size 16

Printed Circuit Board Connectors

LEAVYSEAL CONNECTORS 90° OR STRAIGHT

Materials

Housing: Glass filled PBT
Contacts: CuSn, silver plated

Mating Plugs

21 Pin: 1-1534127-1, 1-2208688-1 (VO rated material)
39 Pin: 5-1718321-3, 5-2208684-3 (VO rated material)
62 Pin: 1-1418883-1 (A key), 2-1418883-1 (B key)
92 Pin: 1-703998-1 (NW 26 wire exit),
3-1703998-1 (NW 29 wire exit)

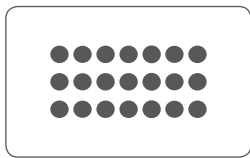

21 Positions
21 size 2.8

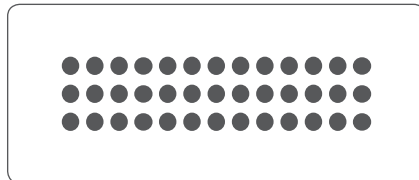

39 Positions
39 size 2.8

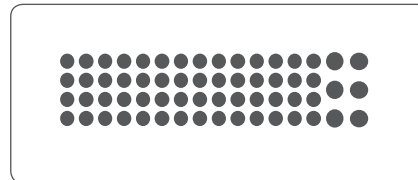

62 Positions
56 size 1.5
6 size 2.8

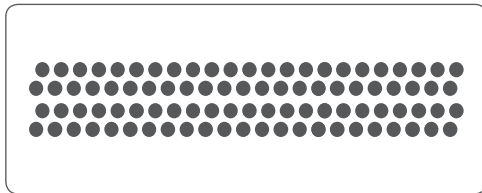

92 Positions
92 size 1.5

Note

See pages 63-78 for comprehensive LEAVYSEAL product information.

STRIKE13/15 SERIES 90° OR STRAIGHT

Materials

Housing: Glass filled PBT
Contacts: Molded-in copper alloy, tin plated (gold plating optional - contact your representative)

Mating Plugs

32 Pin: SRK06-MD*-32A-001

Modifications

G003: Gold plated pins

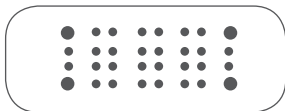

SRK1*-MD*-32A-001-****
4 Size 16
28 Size 20

Note

See pages 161-168 for comprehensive STRIKE series product information.

Printed Circuit Board Connectors

SUPERSEAL 1.0 MM CONNECTORS 90° OR STRAIGHT

Materials

Housing: Thermoplastic
 Contacts: Gold over Ni -
 mating pins, tin-lead over
 Ni - soldering pins

Mating Plugs

26 Pin: 3-1437290-7
 34 Pin: 4-1437290-0
 60 Pin: (1) 3-1437290-7 (26P), (1) 4-1437290-0 (34P)

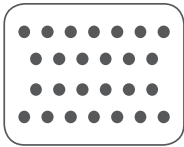

26 Positions
 26 size 1.0 mm

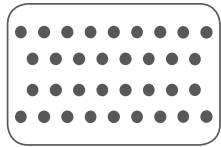

34 Positions
 34 size 1.0 mm

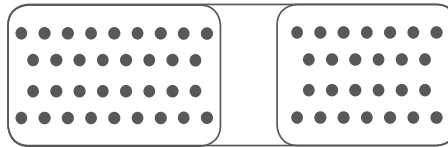

60 Positions
 60 size 1.0 mm

Note

See pages 79-84 for comprehensive Superseal 1.0 product information.

Printed Circuit Board Enclosures and Headers

Compact circuit board enclosures that accept snap-in headers are available. The enclosure features a through hole mounting flange on each side, as well as optional venting. Designed with space to accommodate one or more DT or DTM series interfaces, the headers feature 90° pins. A radial flange seal provides environmental sealing to the enclosure. The headers mate with the DT and DTM standard plugs.



DT SERIES ENCLOSURE WITH HEADER DIMENSIONS

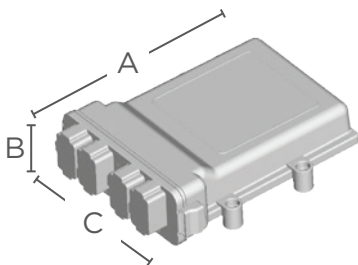

DT Series Enclosure with Header

Overall Length A	Overall Height B	Overall Width C
7.93 (201.30)	2.15 (54.63)	6.30 (160.00)

Dimensions are for reference only

Printed Circuit Board Connectors

DT SERIES HEADER CONNECTOR

Materials

Contacts: Molded-in tin
(gold plating optional - contact
your representative)

Mating Plugs

12 Pin: DT06-12S*
24 Pin: (2) DT06-12S*
36 Pin: (3) DT06-12S*

Modifications

GR02: DT Series snap-in header with
gold plated pins
R015: DT Series snap-in header



DT13-12PA-****
12 size 16
A

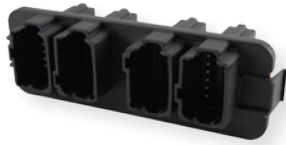

DT13-24PAB-****
(2) 12 size 16
A, B



DT13-36PABC-****
(3) 12 size 16
A, B, C



DT13-48PABCD-****
(4) 12 size 16
A, B, C, D

Note

Keying position of receptacle
must match keying position
of mating plug(s).

DT SERIES PCB ENCLOSURE

Materials

Housing: Thermoplastic

Board Size

5" x 6.50"

Venting

A: With vent hole
B: Without vent hole



EEC-5X650*

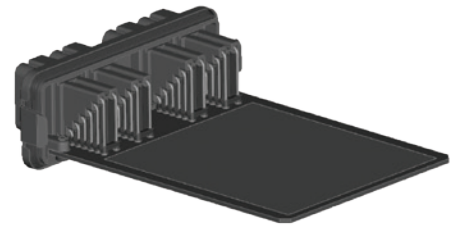
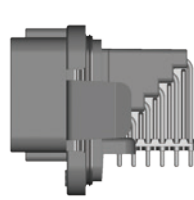

Printed Circuit Board Connectors

DTM SERIES ENCLOSURE WITH HEADER DIMENSIONS

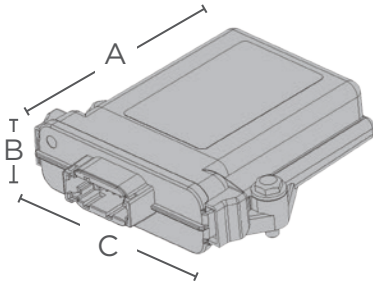

DTM Series Enclosure with Header

Overall Length A	Overall Height B	Overall Width C
5.24 (133.03)	1.42 (36.00)	4.68 (118.80)

Dimensions are for reference only

DTM SERIES HEADER CONNECTOR

Materials

Contacts: Molded-in nickel
mating side, tin plated PCB side

Mating Plugs

12 Pin: DTM06-12S*
24 Pin: (2) DTM06-12S*

Modifications

GR01: DTM Series snap-in
header with gold plated pins



DTM13-12P*-.****
12 size 20
A, B, C, D



DTM13-12PA-12PB-****
(2) 12 size 20
A, B

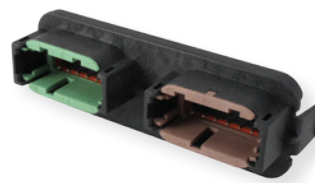

DTM13-12PC-12PD-****
(2) 12 size 20
C, D

Printed Circuit Board Connectors

DTM SERIES PCB ENCLOSURE

Materials

Housing: Thermoplastic

Board Size

3.25" x 4"

Venting

A: With vent hole

B: Without vent hole

Modifications

E016: Molded in clear

Ultem® material

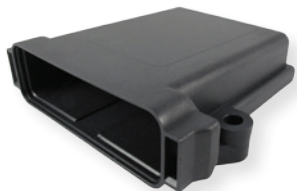
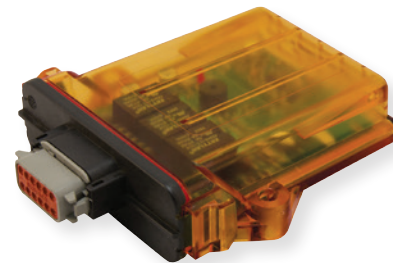

EEC-325X4*

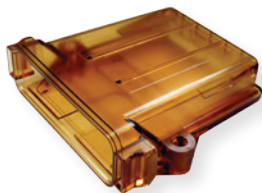

EEC-325X4*-E016

NOTES:

Contents

DTHD Series Overview.....	224
DTHD Series Material Specifications	224
DTHD Series Dimensions.....	224
DTHD Series Ordering Information	225
DTHD Special Modifications	225
DTHD Series Accessories	226
Jiffy Splice Overview	227
Jiffy Splice Dimensions.....	227
Jiffy Splice How To Instructions	227-228

Single Terminal Solutions

Single Terminal Overview

Two different solutions are available for applications that require heavy duty single terminal connections. DEUTSCH DTHD series connectors and Jiffy Splices provide environmentally sealed field-serviceable connections for the full range of wire gauges covered by DEUTSCH contacts. DTHD connectors are heavy duty power terminations for in-line and mounted applications. Jiffy Splices are lightweight in-line splices for quick connections. Both options provide easy installation and service with standard tools and contacts.

DTHD SERIES OVERVIEW

DTHD connectors are single terminal connectors for heavy duty applications. Easy to install, environmentally sealed and compact in size, they are a simple, field serviceable alternative to a splice. DTHD connectors are available in three sizes, carry 25 to 100 amps, and can be mounted or used in-line.



MATERIAL SPECIFICATIONS

Grommet: Silicone rubber

Shell: Unfilled PEI

DIMENSIONS

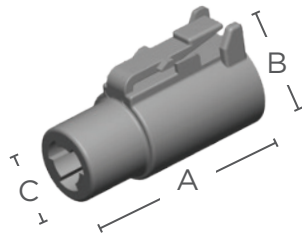

DTHD Plug

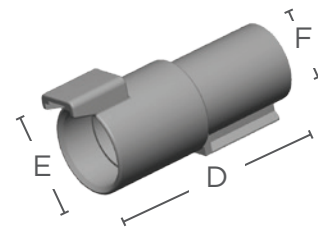

DTHD Receptacle

Contact Size	Overall Length A	Overall Height B	Overall Width C	Overall Length D	Overall Height E	Overall Width F
12	1.498 (38.05)	.771 (19.58)	.570 (14.48)	2.068 (52.53)	.850 (21.59)	.710 (18.08)
8	1.498 (38.05)	.861 (21.87)	.660 (16.76)	2.068 (52.53)	.940 (23.88)	.800 (20.32)
4	1.498 (38.05)	1.076 (27.33)	.875 (22.23)	2.068 (52.53)	1.170 (29.72)	1.045 (26.54)

Dimensions are for reference only.

Single Terminal Solutions

DTHD SERIES PART NUMBERING SYSTEM

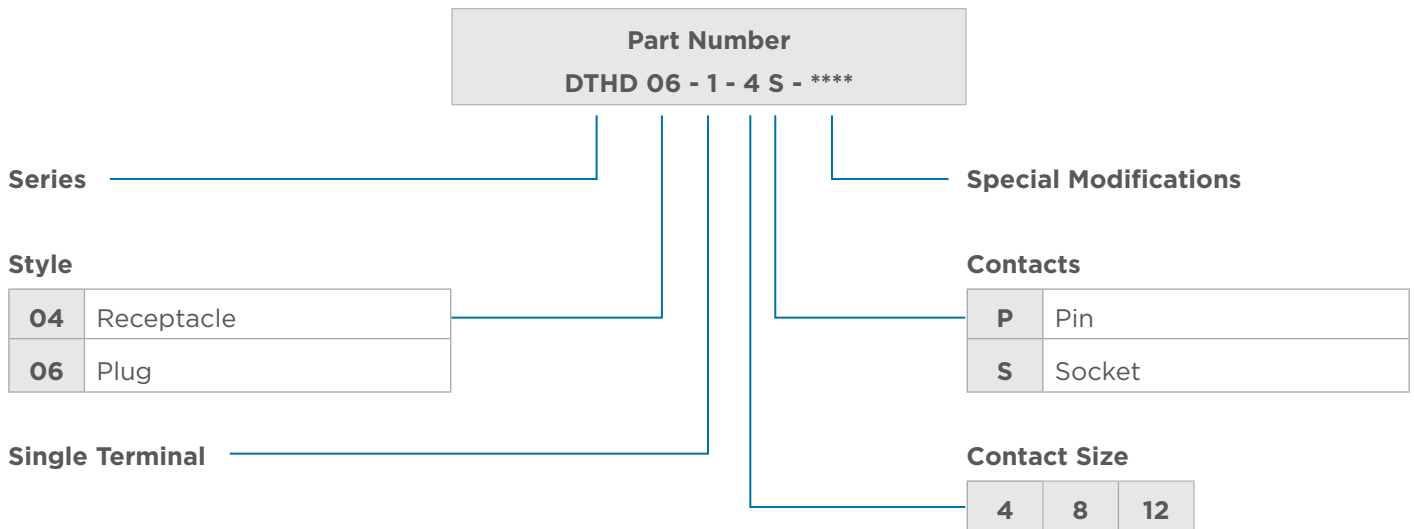

ORDERING INFORMATION

Here are some of the common part numbers in the DTHD series. Several additional connectors may be available.

Position	Contact Size	Plug	Receptacle
1	12	DTHD06-1-12S	DTHD04-1-12P
	8	DTHD06-1-8S	DTHD04-1-8P
	4	DTHD06-1-4S	DTHD04-1-4P

Special Modifications

DTHD series connectors offer modifications to enhance the design flexibility and meet application specific needs. Options include end caps and flanges.



E003 MODIFICATION

The E003 is an end cap modification. The end cap is a protective cap that is sonically welded to the rear of the connector.



L009



L013

L013 & L009 MODIFICATION

The L013 and L009 are sealed flange modifications. The L013 offers outside mounting and the L009 offers inside mounting.

Single Terminal Solutions

Accessories

There is a full line of mounting clips available for use with the DTHD series. The mounting clips offer straight or side mounting and several material options. The mounting clips are designed to be used on all DTHD receptacles.

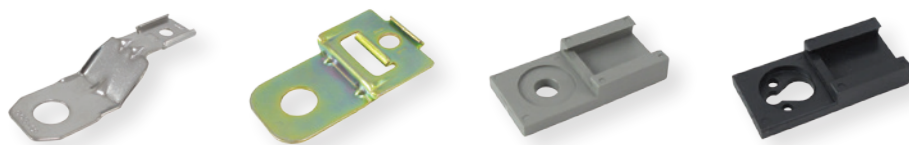

Part Number	Mounting Direction	Color/Material	Hole O.D. inches (mm)
1027-003-1200	Straight	Stainless steel	.433 (11.0)
1027-005-1200	Straight	Stainless steel	.512 (13.0)
1027-004-1200	Straight	Steel w/ zinc plating	.512 (13.0)
1027-008-1200	Side	Steel w/ zinc plating	.433 (11.0)
1027-013-1200/ 1027-017-1200	Side	Steel w/ zinc plating	.323 (8.2)
1011-026-0205	Straight	Gray plastic	.200 (5.08)
1011-030-0205	Straight	Black plastic	-
1011-310-0205* *Connector removeable with 50N of force	Straight	Black plastic	-

Single Terminal Solutions

JIFFY SPLICE OVERVIEW



DEUTSCH Jiffy Splices are a unique, field-serviceable alternative to permanent splices. Made from the same high quality silicone elastomer as DEUTSCH connector seals and grommets, the Jiffy Splice body houses a contact retention system that secures a mated pair of contacts in a compact environmentally sealed unit. Jiffy Splices are easy to install and service.



Part Number	Size	A	B (min.)	Wire AWG	Hole O.D. inches (mm)
JS-04-00	4	3.437 (87.30)	.765 (19.43)	6	.280-.292 (7.11-7.42)
JS-12-00	12	2.500 (63.50)	.500 (12.70)	12-14	.134-.170 (3.40-4.32)
JS-16-00	16	2.465 (62.61)	.385 (9.78)	14-20	.100-.134 (2.54-3.40)

Dimensions are for reference only

Note

Jiffy Splices accept one pin and one socket.

How To Instructions

CONTACT INSERTION



Step 1:
Grasp contact approximately one inch behind the contact crimp barrel.

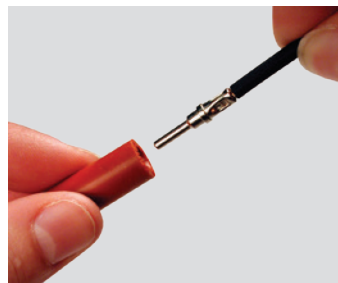

Step 2:
Hold Jiffy Splice between thumb and forefinger approximately one half inch behind cavity.

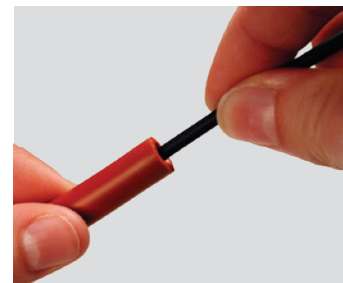

Step 3:
Push contact straight into Jiffy Splice until a positive stop is felt. An audible “snap” will occur when correctly mated. A light tug will confirm it is properly seated.

CONTACT REMOVAL

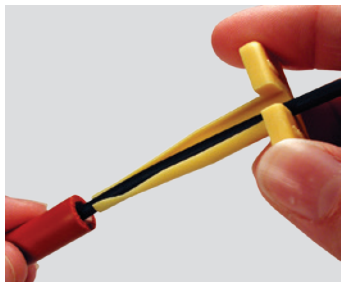

Step 1:
Snap appropriate size removal tool over the wire.

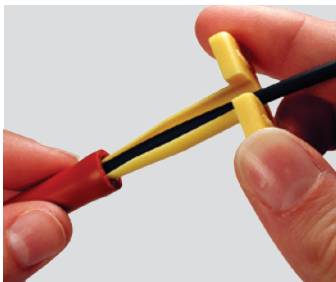

Step 2:
Hold Jiffy Splice between thumb and forefinger approximately one half inch behind cavity. Slide tool into cavity until resistance is felt and retaining fingers are engaged. Do not twist or insert tool at an angle.

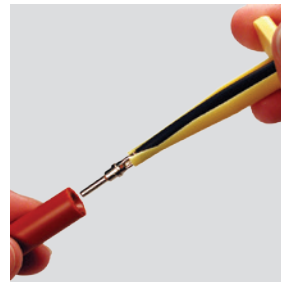

Step 3:
Grip Jiffy Splice between thumb and forefinger and slowly pull contact wire assembly with removal tool out of cavity.

Contents

DEUTSCH Modification List	230-238
Other TE Industrial & Commercial Transportation Products.....	239-240
Requirements & Standards.....	241
Glossary	242-247
Index	248-251

Additional Resources

Modification List

The modification list is only applicable to the DEUTSCH product line and series listed. Modifications listed are for reference only and may not be available for every arrangement.

Mod #	Series	Description
A		
A004	DRC	Receptacle with molded-in PCB pins, 24 and 40 way
A006	DRC	Receptacle with molded-in PCB pins, 40 way, #40 pin removed
<hr/>		
B		
B009	HD10	Receptacle with raised key removed from front of flange, no rear threads
B010	HD10	Plug with coupling ring added
B016	DT, DT13/15	Receptacle has extended shell and enhanced keys, plug has enhanced seal retention (P012), 12 way
B019	HD30	Custom snap ring mount
B022	HD10	Receptacle with D-hole panel mount, rear threads, J1939, black
B025	HD10	Receptacle with D-hole panel mount, no rear threads, black
B026	DTMF	PCB receptacle with alternate keying, requires plugs with WM-12S-B026 wedgelocks
B028	DT15	5 P.S.I rating
<hr/>		
BE		
BE02	DT	Receptacle with extended shell and enhanced keys (B016), end cap
BE03	DT	Receptacle with extended shell and enhanced keys (B016), end cap, black
BE04	DT	Receptacle with extended shell and enhanced keys (B016), end cap, reduced diameter seals (E seal), black
BE05	DT	Receptacle with extended shell and enhanced keys (B016), end cap, sealed flange, reduced diameter seals (E seal), threaded stainless steel flange inserts
<hr/>		
BL		
BL04	DT	Receptacle with extended shell and enhanced keys (B016), welded flange
BL08	DT	Receptacle with extended shell and enhanced keys (B016), welded flange, black

Additional Resources

Mod #	Series	Description
BL10	DT	Receptacle with extended shell and enhanced keys (B016), sealed flange, reduced diameter seals (E seal), shrink boot adapter, threaded stainless steel flange inserts
BL11	DT	Receptacle with extended shell and enhanced keys (B016), sealed flange, reduced diameter seals (E seal), end cap, threaded stainless steel flange inserts

BP

BP03	HD10	Receptacle with D-hole panel mount, J1939 Type II, green
------	------	--

C

C003	HDN	Standard cavity marking identification
C008	DT	Cavity blocked (C)
C012	HD30	Cavities blocked (J, P)
C015	DT, DTP	Reduced diameter seals (E seal)
C016	HD10	Cavities blocked (H, J) - HD10 Series 9 way
C017	DT, DTM, DTP	Solid rear grommet
C018	HD30	Cavities blocked (11, 18, 19), N/E seal options
C019	HD30	Cavities blocked (1, 2, 8, 9), N/E seal options
C020	HD30	Cavities blocked (A, D), N/E seal options
C021	HD30	Cavities blocked (A, B, C, D)
C022	HD30	Cavities blocked (A, D, J, M), with reduced diameter seals (E seal)
C024	HD10	Cavities blocked (B, C, D)
C026	DRC	Cavities blocked, 50 way
C030	HD30, HDP20	Four size 16 cavities blocked (1, 2, 5, 6)
C038	HD30, HDP20	Three size 4, four size 16, requires special size 4 AWG contacts
C041	HDP20	Receptacle with diagnostic keying

CE

CE01	DT	Reduced diameter seals (E seal), end cap
CE02	DT, DTP	Reduced diameter seals (E seal), black
CE03	DT	Reduced diameter seals (E seal), end cap, black
CE04	DT	Reduced diameter seals (E seal), shrink boot adapter

Additional Resources

Mod #	Series	Description
CE05	DT	Plug with reduced diameter seals (E seal), enhanced seal retention (P012), end cap
CE06	DT	Plug with reduced diameter seals (E seal), enhanced seal retention (P012)
CE07	DT	Receptacle with extended shell and enhanced keys (B016), reduced diameter seals (E seal), end cap
CE08	DT	Receptacle with extended shell and enhanced keys (B016), reduced diameter seals (E seal)
CE09	DT	Reduced diameter seals (E seal), shrink boot adapter, black
CE10	DT	Plug with reduced diameter seals (E seal), enhanced seal retention (P012), black
CE11	DT	Plug with reduced diameter seals (E seal), enhanced seal retention (P012), end cap, black
CE12	DT	Plug with reduced diameter seals (E seal), enhanced seal retention (P012), shrink boot adapter, black
CE13	DT	Plug with reduced diameter seals (E seal), enhanced seal retention (P012), shrink boot adapter
CE14	DT	Plug with reduced diameter seals (E seal), enhanced seal retention (P012), latch guard end cap, black
CE27	DT	Plug with reduced diameter seals (E seal), enhanced seal retention (P012), for use with integrated LED wedgelock, end cap, transparent Ultem
CE28	DT	Plug with reduced diameter seals (E seal), enhanced seal retention (P012), for use with integrated LED wedgelock, transparent Ultem

CL

CL01	HD30	Cavities blocked (J, Q, R, S, X), adapter for cable clamp (072)
CL03	DT	Reduced diameter seals (E seal), welded flange
CL07	DT	Reduced diameter seals (E seal), sealed flange, shrink boot adapter
CL08	DT	Reduced diameter seals (E seal), welded flange, end cap, disabled latch
CL09	DT	Reduced diameter seals (E seal), sealed flange, end cap, black
CL15	DT	Reduced diameter seals (E seal), welded flange, black
CL20	HDP20	Plug with diagnostic keying

CG

CG01	DRC	5mm threaded insert with silver plating, molded-in contacts, outside rows gold
------	-----	--

Additional Resources

Mod #	Series	Description
CP		
CP01	DT	All cavities plugged, enhanced seal retention (P012), end cap
<hr/>		
E		
E003	DT, DTHD, DTM, DTP	End cap
E004	DT, DTM, DTP, HD10	Black
E005	DT, DTM, DTP	Black, end cap
E007	DTM	Shrink boot adapter
E008	DT	Shrink boot adapter
E009	DRC	24 way and 40 way receptacle, B keys, housing is gray, flange is black
E016	EEC	Standard EEC box, molded-in transparent Ultem material
E019	AEC	Backshell adapter
<hr/>		
EE		
EE01	DT	Shrink boot adapter, black
EE03	DTM	Shrink boot adapter, black
EE04	DTM	High temp, black
EE05	DT	High temp, enhanced seal retention (P012) on plug, end cap, black
<hr/>		
EF		
EF01	DT	Fluorosilicone front seals, end cap
EF02	DT	Fluorosilicone front seals, latch guard end cap
<hr/>		
EK		
EK02	DT	Plug, 18 cavity DT with 18 size 16 contacts, enhanced seal retention (P012), end cap, "A" key is gray, "B" key is black, "C" key is green, "D" key is brown
<hr/>		
EP		
EP04	DT	End cap (same as E003 mod)
EP05	DT	Latch guard end cap

Additional Resources

Mod #	Series	Description
EP06	DT	Plug with enhanced seal retention (P012), end cap
EP07	DT	Plug with enhanced seal retention (P012), black
EP08	DT	Plug with enhanced seal retention (P012), end cap, black
EP09	DT	Plug with enhanced seal retention (P012), latch guard end cap, black
EP10	DT, DTM	120 ohm terminating resistor (J1939), black
EP11	DT	Plug with enhanced seal retention (P012), shrink boot adapter, black
EP12	DT	Bussed receptacle, 4 and 6 way only, 1 buss, black, gold plated pins
EP13	DT	Bussed receptacle, 4 and 6 way only, 1 buss, black, nickel plated pins
EP14	DT	Bussed receptacle, 6 way, 2 busses, black, nickel plated pins
EP20	DT	Plug with enhanced seal retention (P012), shrink boot adapter

F

F001	HDN	Inserts within connector made of Ultem
------	-----	--

G

G001	DRC	Gold plated pins
G002	DRC	Outside rows of pins are gold plated and rest are tin plated
G003	DT13/15	Gold plated pins
G004	DRC	Interface side pins are nickel plated, PCB side pins are tin plated
G005	DRCP	Tin plated signal pins, tin plated power pins

GC

GC03	DRCP	Gold plated signal pins, depopulated power pins
GC05	DRCP	Tin plated signal pins, depopulated power pins

GR

GR01	DTM13 (EEC headers)	Snap-in DTM PCB mounted header for DTM EEC enclosure, 12 and 24 pins, gold plated pins
------	---------------------	--

H

H001	HD30	Plated with yellow chromate conversion
------	------	--

Additional Resources

Mod #	Series	Description
HL		
HL01	HD30	Dust cap plated with yellow chromate conversion, sash chain with eyelet for #10 screw
HL02	HD30	Adapter for cable clamp (-072) plated with yellow chromate conversion
<hr/>		
J		
J001	HD30	Reverse cavity marking identification on grommet
J059	HD30	Reverse cavity marking identification on grommet, cable clamp (-059)
<hr/>		
K		
K001	AEC	Molded-in shell marking, remove blue stripe, end cap
K003	DT16	Plug, 15 cavity DT with two size 12 contacts and 13 size 16 contacts, enhanced seal retention (P012), end cap, black
K004	DT16	Plug, 18 cavity DT with 18 size 16 contacts, enhanced seal retention (P012), end cap, black
<hr/>		
KP		
KP01	DT16	Plug, six cavity DT with six size 16 contacts, enhanced seal retention (P012), end cap, green
<hr/>		
L		
L001	HD30	Same as -059 (cable clamp)
L003	HD30	Cable clamp adapter (-072)
L005	HD30	Cable clamp adapter (-072) without drain holes
L006	HD30	-059 modification using adapter without drain holes
L009	DTHD	Sealed flange, inside mount
L011	DRC	Wire router
L012	DT, DTP, DTM	Welded flange
L013	DTHD	Sealed flange, outside mount
L015	HDP20	Threaded adapter for backshell strain relief
L017	HDP20	Ring adapter for backshell strain relief
L018	DRB	Wire router
L020	HD30, HD50	Removes #10 eyelet from the dust cap chain

Additional Resources

Mod #	Series	Description
L024	HDP20	Wide threaded adapter for backshell strain relief
L072	HD30	Adapter ring
<hr/>		
LE		
LE01	DT	Sealed flange, inside mount, gasket, end cap
LE03	DT	Sealed flange, outside mount, o-ring sold separately, end cap, NOTE: DT04-08PA-LE03 comes with shrink boot adapter and o-ring on flange
LE05	DT	Sealed flange, inside mount, gasket, end cap
LE06	DT	Sealed flange, inside mount, reduced diameter seals (E seal), end cap
LE07	DT, DTP	Welded flange, end cap
LE08	DT	Welded flange, shrink boot adapter, gray
LE09	DT	Sealed flange, o-ring, end cap, black
LE10	DT	Sealed flange, inside mount, gasket, end cap, black
LE11	DT	Welded flange, end cap, black
LE12	DT	Welded flange, shrink boot adapter, black
LE13	DT	Special adapter, round housing, end cap
LE14	DT	Welded flange, black
LE17	DT	Receptacle with extended shell and enhanced keys (B016), sealed flange, gasket sold separately, end cap, black
LE21	DT	Receptacle with extended shell and enhanced keys (B016), sealed flange, reduced diameter seals (E seal), end cap, one piece connector design, threaded stainless steel flange inserts
<hr/>		
N		
N005	HD10	Receptacle with molded-in PCB pins, modified shell
N006	DT	Receptacle with 90° molded-in contacts
N012	DRC	Receptacle, one piece connector design
<hr/>		
P		
P005	AEC	Special oversized seal on AEC Series plugs and dust caps
P006	DT, DTM	120 ohm terminating resistor (J1939)
P007	DT, DTM	Receptacle “Y” connector (J1939)

Additional Resources

Mod #	Series	Description
P012	DT	Plug with enhanced seal retention, 2-6 way are black, 8 and 12 way "A" key is gray, "B" key is black, "C" key is green, "D" key is brown
P013	DRC	Plug with bonded front seal, silicone adhesive
P016	DT	Bussed receptacle, 12 way, gold plated contacts
P017	DRC	Stainless steel retention clip for jackscrew
P018	DTP	Receptacle with 12 AWG wires attached
P019	DRC	Zinc chromate retention clip for jackscrew
P021	DT	Bussed receptacle, 6, 8, and 12 way, one buss, nickel plated pins
P026	DT	Bussed receptacle, 8 and 12 way, two busses, nickel plated pins
P027	DT	Bussed receptacle, 12 way, two busses, gold plated pins
P028	DT	Bussed receptacle, 8 way, two busses, nickel plated pins
P030	DT	Bussed receptacle, 12 way, four busses, nickel plated pins
P031	DT	Bussed receptacle, 12 way, four busses, gold plated pins
P032	DT	Integrated shrink boot adapter (J1939), black
P060	DT	Bussed receptacle, 2 way, one buss, nickel plated pins
P064	HD30, HDP20	24-91 arrangement without internal jumper
P075	DT	Bussed receptacle, 12 way, three busses, nickel plated pins
P080	HD10	J1939 Type II, green
<hr/>		
PE		
PE01	DT	Latch guard, 120 ohm terminating resistor (J1939)
<hr/>		
PP		
PP01	DT	Plug with enhanced seal retention (P012), 120 ohm terminating resistor (J1939), end cap, black
<hr/>		
R		
R004	DTM13	Custom enclosure header, 90° pins
R005	DTM13	Custom flange, 90° pins
R008	DTM13 (EEC headers)	Snap-in DTM PCB mounted header for DTM EEC enclosure, 12 and 24 pins

Additional Resources

Mod #	Series	Description
R015	DT13 (EEC headers)	Snap-in DT PCB mounted header for DT EEC enclosure, 12, 24, 36, and 48 pins

RT

RT01	DT	Receptacle with MUR 460 diode
RT02	DT	Receptacle with 1N5625GP diode
RT03	DT	Receptacle with MUR 460 diode, 4 way available
RT06	DT	Receptacle with Phillips T.V.S diode 1.5KE130CA, green
RT25	DT	Receptacle with 27k ohm resistor, black

#'s

059	HD30	Addition of threaded adapter and cable clamp assembly
072	HD30	Addition of threaded adapter
1E	HD30	Removes rivet and chain from protective dust cap

Additional Resources

We go to extremes to make every connection count

TE Industrial & Commercial Transportation has a product series for every harsh environment. Our time-tested, high vibration resistant products and technologies provide the right solution for your applications and requirements. In addition to our terminals and connectors, our product portfolio extends to offer sensors, cylinder head wiring, hybrid & electric mobility solutions, relays, and lighting.



SENSORS

TE's broad portfolio of sensor technologies is designed for a wide range of applications. TE's sensors perform under the extreme temperature, vibration, shock, durability and performance profiles required by heavy duty on- and off-highway vehicles. Sensors for engine management, aftertreatment systems, transmissions, vehicle control and management, and cabin and occupant safety are available.



CYLINDER HEAD WIRING

TE offers a full-range of cable products and pass-through connectors for cylinder head wiring that deliver highly integrated systems in harsh environment applications. TE's cylinder head wiring solutions are suitable for heavy duty diesel motors, common rail engines, pump nozzle engines, harness system undervalue cover for injector, and sensor to cylinder head exit connections.



HYBRID & ELECTRIC MOBILITY SOLUTIONS

TE has combined experience in the transportation and high-voltage industries to create safe, reliable, efficient solutions for hybrid and electric vehicles. Our solutions include AK 4.3.3, LV215-1 compliant connections and headers for electric vehicles. Also, by utilizing an integrated internal HVIL that optimizes package size and plug and header selections, multiple wire harness assembly routing options are created.



RELAYS

TE Connectivity's 24V relay product line includes a broad range of robust and versatile relays for many diverse applications within trucks, buses, tractors, construction equipment, and other heavy duty vehicles. With increased contact gaps and other key design features, these relays are designed for use in challenging environments where they may regularly encounter extended periods of shock and vibration.



LIGHTING

Lighting helps to better define space perception and functionality, which increases vehicle safety and human machine interface (HMI). TE offers high-performance, customized solutions for interior and exterior vehicle lighting.

Additional Resources

Requirements & Standards

IMDS

The International Material Data System (IMDS) is a collective, computer-based material data system developed as a collaborative effort by large automotive OEMs to manage environmentally relevant aspects of parts used in vehicles. It has been adopted as the global standard for reporting material content in the automotive industry. TE Connectivity recognizes IMDS and will work with customers that use the system.

IP Rating

The IP Rating system is a way of classifying the degree of protection provided against the intrusion of solid objects, dust, and water in electrical enclosures. The 6 in IP 67 means that the connectors have to be completely sealed from fine dust. The 7 in IP 67 means that the connector needs to be protected from the effects of a one meter submersion. AMPSEAL, AMPSEAL 16, HDSCS, and LEAVYSEAL connectors are IP 67 rated. DEUTSCH connectors are rated IP 68. The 8 in IP 68 means that the connector needs to be protected from the effects of immersion in water under pressure for long periods.

IP6K9K

IP6K9K is similar to the standard IP Ratings, but is commonly referred to as a pressure washing specification. The letter K is used after the numbers to denote special testing. The 6K means the connectors need to be completely sealed from fine dust. The 9K means the connector needs to be protected from the penetrating effects of water used for high pressure/steam jet cleaning purposes. Several DEUTSCH connectors in the DT, DTM, DRC, and DRB series have been through independent lab testing and pass IP6K9K, as well as AMPSEAL connectors. HDSCS and LEAVYSEAL connectors used with the appropriate accessories meet the IP6K9K standard.

J1939/11, J1939/13, and J1939/15

See CAN section.

J2030

J2030 is an SAE standard for connectors between two cables or between a cable and an electrical component. The standard primarily focuses on the connectors used to mate to the electrical component. J2030 also provides environmental test and acceptance criteria for connectors used in DC electrical systems of 50 V or less in heavy duty applications typically used in off-highway equipment. Severe applications may require more rigid test levels, or field-testing on the intended application. AMPSEAL 16 connectors meet the SAE J2030 standard.

RoHS

The Restriction of Hazardous Substances (RoHS) in electrical and electronic equipment is a European directive. The directive restricts the use of lead, mercury, cadmium, hexavalent chromium, polybrominated biphenyls, and polybrominated diphenyl ether in new electrical and electronic components. To verify individual product compliance, please visit <http://www.te.com/commerce/alt/product-compliance.do>.

UL Recognized

A UL Recognized Component is one that is to be installed within a larger assembly by a manufacturer, and this larger assembly is then expected to be tested by UL to become UL LISTED. AMPSEAL, AMPSEAL 16, and many DEUTSCH connectors are UL Recognized Components. DEUTSCH connectors that are UL Recognized Components include the AEC, DRC, DT, DTM, DTP, HD10, and HDP20 series. Not every variation and/or modification within a DEUTSCH series may be UL Recognized Components. AMPSEAL connectors are UL 94 V0 rated. LEAVYSEAL and HDSCS products constructed with a UL 94 V0 rated material are available. For additional information, visit www.ul.com.

Glossary

AWG (American Wire Gauge): Standardized system of wire diameter measurement. Commonly referred to as wire gauge. (Reference: National Bureau of Standards, Copper Wire Table [Handbook 100] AVS.)

Adapter: Device attached to a connector to allow connection to a second device that it would not otherwise be able to attach.

Ambient Temperature: The temperature of a medium (gas or liquid) surrounding an object.

Ampere (amp): The unit of current. One ampere is the current flowing through one ohm of resistance at one volt potential.

ARC Resistance: Time required for an electrical current to render the surface of a material conductive due to carbonization by the arc flame. Or, the time required for an arc to establish a conductive path in a material.

Applicator: Tooling used in automatic machines to crimp stamped & formed contacts.

Backshell: A secondary attachment for the rear of a connector to provide strain relief, environmental protection, and/or improved aesthetics.

Barrel: (1) Conductor Barrel: the section of the terminal, splice, or contact that accommodates the stripped wire. (2) Insulation Barrel: the section of the terminal, splice, or contact that accommodates the unstripped wire.

Barrel Chamfer: Beveled entry at mating end of the socket contact. Reduces contact mating force for easier connector mating.

Blocked Cavities: Unused holes or contact positions in a connector which have been filled with sealing plugs or made inaccessible by modification to the rear grommet.

Breakaway: Connector with a slotted coupling ring. Coupling ring is intended to fragment and allow connectors to separate without damage to the implement in the event of an unintended pull-away.

Boot: Attachment for the back of a connector. Boots are typically flexible, made from plastic or plastisol, and may provide wire strain relief, environmental protection, and/or improved aesthetics.

Bulkhead: Dividing wall or partition. Bulkhead connectors are designed to be mounted to a dividing wall through a cutout.

Buss (also bussbar, bus or busbar): A thin conductive strip connecting multiple contacts within the body of a connector. Used to distribute electrical current to the branches of a circuit.

Cable Clamp: An attachment to provide support and strain relief to the wire bundle where it exits the connector.

Cavity: Hole in the connector grommet and housing, into which the contact must fit.

Cold Heading: Process by which contacts are formed from individual pieces of metal using dies and punches.

Compression Nut: Secondary backshell assembly. Threads onto rear of backshell to compact the wire bundle and provide additional support.

Conductivity: The capability of a material to carry an electrical current.

Conductor: Any material capable of carrying an electrical charge easily. The most common materials for wire and cable applications are aluminum and copper (bare or coated).

Connector Position Assurance (CPA): A locking mechanism on the connector that prevents the mated connectors from accidental unmating.

Glossary

Contact: Conductive device crimped or soldered onto the end of conductor wire to allow the transfer of electricity or data to a second conductor. Contacts are most frequently used in multiples in connectors. Also commonly referred to as terminals, pins and/or sockets.

Contact, Crimp: Wire termination engineered to be permanently applied to conductor wire end with pressure. Does not use solder or heat.

Contact, Insertable/Removable: Wire termination that can be mechanically joined to or removed from the connector body.

Contact, Pin: Wire termination with solid mating end. Provides connection by insertion into a female or socket contact. Also referred to as male contact.

Contact, Receptacle: Wire termination with hollow mating end into which the pin or male terminal is inserted. Also referred to as a female contact.

Contact, Socket: Wire termination with hollow mating end into which the pin or male terminal is inserted. Also referred to as a female contact.

Contact, Solder: Wire termination joined to the wire conductor with a metal joining compound. Contacts intended for solder will typically have a cup, hollow-cylinder eyelet or hook to accept a conductor and retain the applied solder.

Contact Area: The area where two conductors, a wire termination and a conductor, or two wire terminations touch, permitting the flow of electricity.

Contact Arrangement: The number, spacing, and organization of cavities in a connector.

Contact Rating: The maximum recommended amperage to be passed through a wire terminal.

Contact Resistance: The measurement of opposition to electrical flow through a pair of mated wire terminations. Resistance may be measured in ohms or in millivolt drop at a specified current over the mated terminals.

Contact Retention: The axial load in either direction that a terminal can withstand without being dislodged from its correct position in the connector.

Contact Shoulder: A small flange or collar on a terminal that limits the contact's travel into or removal from the connector.

Contact Size: Overall size of barrel determined by size of wire it will accept.

Controller Area Network (CAN): Multiplex data systems. Multiplexing allows multiple data signals to travel on the same wires, integrating separate electronic systems and applications to a single point control and monitoring system. SAE J1939/11, J1939/13, and J1939/15 are specific types of controller area networks.

Corrosion Resistance: The ability of a substance to withstand corrosion.

Coupling Ring: Attached cylindrical ring used to lock mated connectors together.

Crimping: To mechanically secure a terminal or splice to a conductor by use of pressure.

Crimping Die: The part of a crimping tool that physically compresses the contact barrel and shapes the crimp.

Crimp Tool: Implement that permanently attaches a contact to a wire using pressure.

Current (I): The rate of transfer of electricity usually expressed in amperes.

Current Rating: The maximum continuous electrical flow of a current recommended for a given wire situation. Expressed in amperes.

Dielectric Strength: The voltage which an insulating material can withstand before breakdown occurs, usually expressed as a voltage gradient (such as volts/mil).

Glossary

Dielectric Test: A test in which a voltage higher than the rated voltage is applied for a specific time to determine the adequacy of the insulation under normal conditions.

Dielectric Withstanding Voltage: The amount of leakage current that flows through the insulation.

Diode: Electronic component that allows electrical flow in one direction only.

Direct Current: An electrical current that flows in one direction only.

Dust Cover: Cap used to protect and conceal the interface of an unmated connector.

“E” Seal: Reduced diameter insert cavity in the rear grommet. Creates a proper seal with smaller than standard wire or insulation. Also referred to as extra thin or European seal. “E” seals are smaller than “N” and “T” seals.

End Cap: A protective cover integral to, or sonically welded onto the rear of a connector.

Engaging and Separating Force: Measured pull required to mate or unmate contacts or connectors.

Enhanced Key: Additional indexing or polarization to help prevent mis-mating.

Enhanced Seal Retention: Modification to the plug, front seal, and wedgelock to help prevent the seal from separating from the connector during unmating.

Environmentally Sealed: Maintains functionality when exposed to environmental elements.

Extraction Tool: An implement for removing contacts from a connector.

Flange: A flat, perpendicular extension of the connector body. Flanges are used for mounting and are typically found on receptacles.

Flange Seal: Elastomeric silicone seal used between flange and mounting surface to prevent leakage around the mounting cutout.

Front Seal: Elastomeric silicone seal or o-ring on the mating face of a connector. The front seal is also referred to as an interfacial seal and is usually found on the plug.

Grommet: Rubber or elastomeric seal. On connectors the grommet is on the rear or cable end of the connector and has the cavities through which the contact is inserted into the connector body.

Ground: A conducting connection between an electrical circuit and the earth or other large conducting body to serve as an earth thus making a complete electrical circuit.

Header: Flanged connector designed for wire to printed circuit board applications.

Heat Seal: In cabling, a method of sealing a tape wrap jacket by means of thermal fusion.

Heat Shrink: Type of tubing that shrinks to form a tight bond when heated.

Indenter: The part of a crimp tool or die that compresses the contact barrel onto the conductor.

In-line: Connectors that are not intended for use in mounted or PCB applications.

Insertion Tool: A device used to guide contacts into proper position within a connector.

Inspection Hole: An opening in a barrel contact to allow visual inspection of the conductor to verify that it has been inserted to the right depth.

Insulation Resistance: The measure of resistance offered by insulation material to the flow of current.

Insulation: A material having high resistance to the flow of electric current.

Glossary

Insulation Crimp: (1) The physical deformation of the insulation sleeve covering a terminal or splice and the adjacent conductor insulation to hold the sleeve in place; (2) Shape combination of insulation sleeve to terminal or splice and conductor insulation after crimping.

Insulation Resistance: That property of an insulating material which resists electrical current flow through the insulating material when a potential difference is applied.

Insulation Support: The portion of the contact barrel enclosing but not crimped to the conductor insulation.

Interface: The surfaces of a mating pair of connectors that face each other when connected.

Interfacial Seal: A seal at the mating edge of the connector to prevent ingress of moisture or contaminants when a connector is properly mated.

Internal Seal: Waterproof form, typically made of silicone elastomer, that is inside the body of the connector. Provides moisture and fluid resistance when connectors are properly mated.

IP Rating: A way of classifying the degree of protection provided against the intrusion of solid objects, dust, and water in electrical enclosures.

Jacket: An outer nonmetallic protective covering applied over an insulated wire or cable.

Key: Unique pattern of corresponding notches and projections on a set of mating connectors. The projections are intended to match the notches and prevent mis-mating.

Keying Pin: Solid plastic rod designed to be inserted into an empty socket cavity to help prevent mis-mating.

Locator: A device in a crimp tool to help provide proper contact position during crimping.

Lockwasher: Thin metal ring used between the panel nut and mounting surface to create spring force to confirm a tight fitting mount.

Millimeters Squared or mm²: Unit of measure for European Wire Size Standards (ref. DIN 72551-6 and ISO 6722-3).

Moisture Resistance: Amount of water (in any form) that a properly wired and mated connection will withstand without loss of electronic qualities or leakage.

Mounting Bracket: A rectangular metal device used to attach or mount connectors in an application.

Mounting Clip: A plastic or metal piece that attaches to a non-flanged connector to allow surface mounting.

“N” Seal: Normal wire seal diameter.

Neoprene: Thermosetting material, chemically known as polychloroprene, with excellent flame retarding and abrasion resisting qualities.

Nest: The part of a crimping die that supports the barrel during crimping.

Newton (N): A unit of force which is based on the metric system. It is the force that produces an acceleration of 1 meter per second per second when exerted on a mass of 1 kilogram.

O-ring: Circular seal found around the inside diameter of a receptacle: typically made from elastomeric or silicone material. Provides an environmental seal.

Oxidation: The process of uniting a compound with oxygen, usually resulting in an unwanted surface degradation of the material or compound.

Panel Nut: A hexagonal threaded plastic or metal ring. Along with a lockwasher, a panel nut is used for mounting.

Partial Strip: A quantity less than a standard full reel of stamped & formed contacts.

PCB (Printed Circuit Board) Mount: Connectors designed for wire to printed circuit board applications.

Glossary

Peak Voltage: The maximum instantaneous voltage.

Pin Housing (Cap): One half of a mated pair of connectors. AMPSEAL 16 pin housings mate with a receptacle contact housing (plug) and house pin contacts.

Plating: Thin overlay coating of metal on contacts or components. Can be used to improve conductivity, provide for easy soldering, and prevent corrosion.

Plug: One half of a mated pair of connectors. Plugs typically have the locking mechanism for the mated pair, usually house the sockets, and mate with a receptacle.

Pre-Tinned: Solder applied to the contact and/or conductor prior to soldering.

Primary Latch Reinforcement (PLR): Locking mechanism that snaps into place on the mating face of a connector after the connector is populated. A PLR holds contacts in correct alignment for mating and prevents them from being removed.

Pull-Out Force: Measured energy required to separate a conductor from a contact, or a contact from a termination assembly.

Ratchet Control: A crimping device that helps provide a full crimping cycle by allowing motion in only one direction until contact is fully crimped.

Receptacle: One half of a mated pair of connectors. Receptacles mate with a plug and usually house pins.

Receptacle Housing (Plug): One half of a mated pair of connectors. AMPSEAL and AMPSEAL 16 plugs typically have the locking mechanism for the mated pair, house the receptacle contacts, and mate with a pin housing (cap) or header.

Reduced Diameter Seal: Smaller than standard holes in the connector grommet.

Removal Tool: Device to disengage contacts from connector body.

Retaining Bolt: Screw used to draw and hold mating connectors together.

Retaining Sleeve: Lining sheath that fits into receptacle body to maintain internal seal and provide keying.

Reverse Arrangement: Non-standard cavity/contact assignment (eg. Plug connectors that require pin contacts, and receptacles that require socket contacts).

Ring Adapter (HDP20): Cylindrical rim or collar attached to the rear of a connector to allow the attachment of backshells or strain relief.

Sealed Flange: A flange that is molded or tooled as an integral part of the connector body to help prevent leakage at the mounting site.

Sealing Plug: A non-conductive dummy pin inserted to fill an open cavity in a connector. Sealing plugs are required to maintain the integrity of the environmental seal.

Seamless Terminal or Splice: Terminal or splice conductor barrel made from a single piece of metal, finished without lines or grooves that would typically appear where metal is joined to metal.

Secondary Lock: Device inserted into or onto the connector interface to position and hold contacts in correct alignment. Secondary locks are called wedge-locks or terminal position assurance.

Self-Extinguishing: The characteristic of a material whose flame is extinguished after the igniting flame is removed.

Selective Plating: Application of a thin coating of a finish metal to specific parts of a contact, but not to others. If selective plating is used, plating is typically applied to the mating surface to provide better conductivity and reduce wear and corrosion.

Shells: Outside case into which the insert and contacts are assembled. Shells of mating connectors usually also provide proper alignment and protection of projecting contacts. Also known as housing or body.

Glossary

Shield: A metallic layer, commonly aluminum or copper, of tape, braid or spiral wrapped wire construction. Its primary purpose is to prevent electrostatic or electromagnetic interference between adjacent wires and external sources.

Shielded Cable: A cable in which the insulated conductor or conductors is/are enclosed in a conducting envelope or envelopes. Constructed so that essentially every point on the surface of the insulation is at ground potential or at some predetermined potential with respect to ground.

Shrink Boot Adapter: Thermoplastic rear adapter designed to provide a lip for heat shrink to form around to attach it securely to a connector.

Signal: An electric current used to convey information either digital, analog, audio or video.

Sleeving: A braided, knitted or woven tube.

Splice: A connection of two or more conductors or cables to provide good mechanical strength as well as good conductivity.

Socket Contact Sleeve: A cylindrical, protective encasement for the contact fingers or a contact spring. The socket contact sleeve holds the inner mechanism of the contact in place and provides a smooth exterior surface.

Solderless Connection: Joint between two metals created by pressure without the use of metallic alloy compounds or heat.

Solid Contact: Closed barrel terminal manufactured using a cold heading process.

Stamped & Formed Contact: Open barrel terminal manufactured using a precision stamping process.

Strain Relief: Hard plastic or metal device that attaches to the rear of a connector to provide wire support.

Strand: A single filament of uninsulated wire.

Strip: To remove insulation from a conductor.

Swedge: A cold-forging process to press-fit or force two metal forms into one.

“T” Seal: Reduced diameter insert cavity in the rear grommet. Also referred to as thin seal, a “T” seal allows for the use of smaller wire or thinner insulation diameter. A “T” seal is larger than an “E” seal and smaller than an “N” seal.

Temperature Coefficient of Resistivity: The change in resistance per degree of change in temperature.

Terminal: A device designed to attach to the end of a conductor wire to allow it to connect to another conductor wire and allow electrical current to pass between them. Also commonly referred to as a contact.

UL Recognized Component: One that is to be installed within a larger assembly by a manufacturer, and this larger assembly is then expected to be tested by UL to become UL Listed.

Topic	Page	Topic	Page
A		Crimp sleeve reducer	177
Adapters		D	
072 adapter.....	154	D hole punch	159
L015 conduit adapter.....	156	Dimensions	
L015 threaded adapter.....	153	AEC series.....	87
L017 ring adapter.....	153	AMPSEAL.....	13
L024 wide threaded adapter.....	153	AMPSEAL 16.....	23
Shrink boot adapter.....	120	Bussed feedback receptacles.....	193
Adapters, mounting		Circular DIN.....	37
LEAVYSEAL.....	70	Diodes & Resistors.....	208-208
AEC series	85-90	DRB series.....	93
AMPSEAL	11-20	DRC series.....	101
AMPSEAL 16 hybrid lever	27	DT/DTM series.....	112
B		DTP series.....	113
Backshells. See also Wire cover, Wire relief		DTHD series.....	224
Circular DIN.....	39	DTMH series.....	129
DRC series.....	106	DTV series.....	131
DTM series.....	126	EEC enclosures.....	218, 220
DT series.....	124-125	HD10 series.....	135
HD10 series.....	139	HD30/HDP20 series.....	147
HD30/HDP20 series.....	156-157	HDSCS.....	47
HDSCS.....	51	Jiffy Splices.....	227
LEAVYSEAL.....	69	LEAVYSEAL.....	65
STRIKE series.....	165	STRIKE series.....	163
Boots		Superseal 1.0.....	81
AEC series.....	89	Diodes & Resistors	205-208
DRB series.....	97	DRB series	91-98
DRC series.....	107	DRC series	99-108
DT/DTM/DTP series.....	122-123	DT/DTM/DTP series	109-128
HD10 series.....	140	DTHD series	224-226
HD30/HDP20 series.....	154	DTMH series	129
Breakaway connector		DTV series	131
HD30 series.....	153, 196	Dust caps. See also Covers, Protection caps/covers	
Bussing Options	191-194	AEC series.....	89
C		DT/DTM series.....	131-132
CAN (Controller Area Network)	195-200	HD10 series.....	141
Contacts		HD30/HDP20 series.....	155
1.0 mm.....	83	E	
1.3 mm.....	15-16	EEC enclosures	218-221
2.5 mm.....	39-41	End caps	
AMP MCP.....	53-55	DT Series.....	119
DEUTSCH.....	169-180	“E” seal	
HDSF 16.....	29-30	DT Series.....	119
Coupling rings		Extraction tool. See also Removal tools	
HD10 series.....	138	Circular DIN.....	44
Covers		F	
Circular DIN.....	38	Fixing slides	
Crimp		HDSCS.....	52
General.....	175		
Inspection.....	176		

Topic	Page	Topic	Page
Flange modifications		K	
DTHD series.....	225	Keying pins	177
DT series.....	120	L	
Flanges		Lanyards	
DRB series.....	96	HD10 series.....	142
G		Locking slides	
Gaskets		LEAVYSEAL.....	70
DRC series.....	107	Lockwashers	
DT/DTM/DTP series.....	121	HD30/HDP20 Series.....	157
HD10 series.....	141	M	
HD30/HDP20 series.....	157	Material specifications	
H		AEC series.....	86
HD10 series	133-144	AMPSEAL.....	13
HD30/HDP20 series	145-160	Circular DIN.....	36
I		DRB series.....	92
Insert/removal tools		DRC series.....	100
AMPSEAL 16.....	32	DT Family.....	111
Circular DIN.....	44	DTHD series.....	224
DEUTSCH.....	187	HD10 series.....	134
HDSCS.....	60	HD30/HDP20 series.....	147
Instructions (How To)		HDSCS.....	47
AEC series.....	89	LEAVYSEAL.....	64
AMPSEAL.....	18-19	STRIKE series.....	162
AMPSEAL 16.....	33	Superseal 1.0.....	80
Crimp sleeve reducer.....	180	Modifications	
DRB series.....	97-98	Descriptions.....	230-238
DRC series.....	107	059.....	154
DT Family.....	132	072.....	154
DTT style hand tools.....	189	B010.....	138
HD10 series.....	143	B016.....	118
HD30/HDP20 series.....	159-160	BL04.....	120
HDSCS.....	60-61	BL08.....	120
HDT-48-00 hand tool.....	188	BL10.....	120
Jiffy Splice.....	227-228	BP03.....	138
LEAVYSEAL.....	78	C015.....	119
Sealing plugs.....	179	C030.....	153
STRIKE series.....	166-167	C041.....	154
Wire stripping.....	188	CE27.....	119
ISO box	196	CE28.....	119
J		CL03.....	120
J1939		CL07.....	120
J1939/11.....	198-199	CL09.....	120
J1939/13.....	200-201	CL20.....	154
J1939/15.....	202-203	Detector.....	119
Jiffy Splices	227-228	E003.....	119, 225
		E004.....	120, 138
		E005.....	120
		E007.....	120
		E008.....	120
		EP13.....	194
		EP14.....	194
		L006.....	154

Topic	Page	Topic	Page
L009.....	225	DRC series.....	100
L012.....	120	DT Family.....	111
L013.....	225	HD10 series.....	134
L015.....	153	HD30/HDP20 series.....	146
L017.....	153	HDSCS.....	46
L024.....	153	HDSF 16.....	29
LE01.....	120	LEAVYSEAL.....	64
LE05.....	120	STRIKE series.....	162
LE06.....	120	Superseal 1.0.....	80
LE07.....	120	Primary latch reinforcement (PLR)	24
LE08.....	120	Protection caps/covers	
LE09.....	120	HDSCS.....	52
LE10.....	120	LEAVYSEAL.....	71
LE11.....	120		
LE12.....	120	S	
LE14.....	120		
LE17.....	120	Sealing plugs	
LE21.....	120	AMPSEAL.....	16
N005.....	138	AMPSEAL 16.....	31
P012.....	119	Circular DIN.....	42
P016.....	194	DEUTSCH.....	178
P021.....	194	HDSCS.....	56, 74
P026.....	194	Superseal 1.0.....	83
P027.....	194	Shrink boot adapter	
P028.....	194	DT/DTM series.....	120
P030.....	194	Standards	241
P031.....	194	Strain relief	
P060.....	194	DT series.....	124
P064.....	149	HD10 series.....	140
P075.....	194	HD30/HDP20 series.....	155-156
P080.....	138	Superseal 1.0	79-84
Mounting clips. See also Fixing slides, Locking slides		T	
AMPSEAL 16.....	26		
DT/DTM/DTP series.....	127	Tooling	
DTHD series.....	226	Automated crimp tools	
Mounting ring		AMPSEAL.....	17
Circular DIN.....	39	AMPSEAL 16.....	32
		Circular DIN.....	43-44
P		DEUTSCH.....	182-184
		HDSCS.....	58-59, 76-77
Panel nut		Superseal 1.0.....	84
HD30/HDP20 series.....	158	DEUTSCH.....	181-190
PCB pins	174	Hand crimp tools	
PCB (Printed Circuit Board)	209-222	AMPSEAL.....	17
Performance specifications		AMPSEAL 16.....	31
1.0 mm contacts.....	83	Circular DIN.....	42
1.3 mm contacts.....	15	DEUTSCH.....	185-186
2.5 mm contacts.....	39	HDSCS.....	57, 75
AEC series.....	86	Superseal 1.0.....	84
AMP MCP contacts.....	53, 71	Removal tools	
AMPSEAL.....	12	AMPSEAL 16.....	32
AMPSEAL 16.....	22	Circular DIN.....	44
Circular DIN.....	36	DEUTSCH.....	187
DEUTSCH contacts.....	171	HDSCS.....	60
DRB series.....	92		

Topic	Page	Topic	Page
Tooling accessories	183, 186		
W			
Wedgelocks			
DRB series.....	96		
DT/DTM/DTP series.....	117		
DTV series.....	131		
Wire cover			
AMPSEAL 16.....	28		
Wire relief			
AMPSEAL.....	15		
Wire router			
DRC series.....	106		
Wire sealing ranges			
AEC series.....	88		
AMPSEAL.....	15		
AMPSEAL 16.....	25		
DRB series.....	95		
DRC series.....	105		
DT Family	116		
HD10 series.....	137		
HD30/HDP20 series.....	152		
STRIKE series.....	165		
Wire seals			
Circular DIN.....	42		
HDSCS.....	56		
LEAVYSEAL.....	74		

NOTES:

LET'S CONNECT

We make it easy to connect with our experts and are ready to provide all the support you need. For additional information or product assistance, please contact your field representative or our customer service department. Additional information is also available on the website <http://www.te.com/usa-en/industries/truck-bus-off-road-vehicles.html>.

TECHNICAL SUPPORT

te.com/support-center

Asia:

+86 400-820-6015

Europe, Middle East, & Africa:

+49 6251-133-0

North America:

+1-888-441-9982

te.com

TE Connectivity, TE connectivity (logo), LADD, EVERY CONNECTION COUNTS, AMP, AMP MCP, AMPSEAL, AMPSEAL 16, CERTI-CRIMP, CERTI-LOK, DETECTOR, DEUTSCH, ERGOCRIMP, LEAVYSEAL, PRO-CRIMPER, and STRIKE, are trademarks.

USCAR is a trademark.

All other logos, products and/or company names referred to herein might be trademarks of their respective owners.

The information given herein, including drawings, illustrations and schematics which are intended for illustration purposes only, is believed to be reliable. However, TE Connectivity makes no warranties as to its accuracy or completeness and disclaims any liability in connection with its use. TE Connectivity's obligations shall only be as set forth in TE Connectivity's Standard Terms and Conditions of Sale for this product and in no case will TE Connectivity be liable for any incidental, indirect or consequential damages arising out of the sale, resale, use or misuse of the product. Users of TE Connectivity products should make their own evaluation to determine the suitability of each such product for the specific application.

© 2015 TE Connectivity Ltd. family of companies All Rights Reserved.

TS-ICT-T&CCAT 08/15 Original

TE Connectivity

4849 Hempstead Station Drive
Kettering, OH 45429
USA

Tel: +1-888-441-9982

Fax: +1-937-312-9731

www.te.com