

# SNK SERIES TERMINAL BLOCKS

PI-Spring, screw clamp and  
pluggable technologies

ENTRELEC Terminal Blocks

Here is the first SNK Series Terminal Blocks interactive catalog which contains numerous new functionalities:

- ✓ Additional information, about the product pages: in the table, click on the product order code to obtain the data sheet, the agreement and all technical information regarding that reference.
- ✓ A dedicated page to the SNK challenge videos and the SNK video

- ✓ A tab system on the side of the Flipbook helps you navigate easily inside the catalog
- ✓ Interactive summaries. One click on an entry leads you to the desired page.

Receive one link only in your email to open the Flipbook; once opened, you can download the PDF, only if you need to. No overload in your email box nor on your hard drive.

### ZK2.5 PI-Spring terminal blocks

Feed-through - 5.2 mm 0.205 in spacing



2.5 mm<sup>2</sup>  
12 AWG

**Description**

Combine high performance with compact dimensions:  
 - 1000 V AC / DC IEC 600 V UL  
 - Opt for the best marking visibility thanks to the up-front, flat marker zone, which lets you mark up to eight digits or increase the font size.

**Ordering details**

Description	Color	Type	Part Number	Pkg	Weight (1 post) g
Feed-through 2 connections	Grey	ZK2.5	1SNK705010R0000	50	5,50
	Blue	ZK2.5-BL	1SNK705020R0000	50	5,50
	Orange	ZK2.5-OR	1SNK705030R0000	50	5,50
	Yellow	ZK2.5-YL	1SNK705060R0000	50	5,50
	Green	ZK2.5-GN	1SNK705061R0000	50	5,50
	Red	ZK2.5-RE	1SNK705062R0000	50	5,50
	White	ZK2.5-WH	1SNK705065R0000	50	5,50
	Black	ZK2.5-BK	1SNK705066R0000	50	5,50



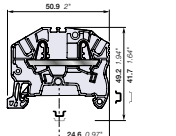

5.2 mm 0.205 in spacing

**Main technical data**

Connecting capacity	IEC	UL - CSA	Rail	TH SS-7,5, TH SS-15
1 conductor per clamp	Rigid: Solid/Stranded Flexible without ferrule Flexible with non insulated ferrule Flexible with insulated ferrule	0.2 ... 4 mm <sup>2</sup> 0.22 ... 2.5 mm <sup>2</sup> 0.22 ... 2.5 mm <sup>2</sup> 0.22 ... 2.5 mm <sup>2</sup>	26 ... 12 AWG 26 ... 14 AWG 26 ... 14 AWG	Wire stripping length 11 mm 0.433 in
2 conductors per clamp	Flexible with twin ferrule	0.22 ... 0.5 mm <sup>2</sup>	26 ... 20 AWG	Tool for flexible conductor without ferrule Flat screwdriver Ø 3.5 mm Ø 0.138 in

**Rated current / Rated cross section**  
 24 A / 2.5 mm<sup>2</sup>    20 A / 12 AWG

**Rated short-time withstand current (I<sub>st</sub>)**  
 300 A    336 A

**Short Circuit Current Rating (with specific conditions)**  
 100 kA

**Rated voltage**  
 1000 V    600 V

**Impulse withstand voltage**  
 6000 V

**Protection**  
 IP20    NEMA 1

**Increased safety Ex e**    IEC EN 60079-7 - IM2 II 2 GD Ex eb IIIC

The connecting capacity data for one rigid, solid/stranded, or one flexible conductor (when applicable) is mandatory information required by IEC, UL and CSA standards (Copper conductors). All other data are provided as supplementary information only. For more details, please consult our CE, UL or CSA certificates and technical datasheet available on http://www.te.com

**Accessories**

Description	Color	Type	Part Number	Pkg	Weight (1 post) g
1 End stops	Dark grey	BAZ1	1SNK900002R0000	50	5,30
2 End sections	Dark grey	EPK2.5	1SNK705910R0000	50	1,80
3 Jumper bars	Orange	JBS-2	1SNK905320R0000	50	1,30
	Orange	JBS-3	1SNK905330R0000	50	2,00
	Orange	JBS-4	1SNK905304R0000	50	2,70
	Orange	JBS-5	1SNK905305R0000	50	3,50
	Orange	JBS-10	1SNK905310R0000	30	7,10
4 Cross spacing jumpers	Orange	JBS-50	1SNK905350R0000	10	36,00
5 Circuit separators	Dark grey	CS-R2	1SNK900106R0000	20	3,80
6 Test adapters	Dark grey	TP2	1SNK900203R0000	20	1,70
	Dark grey	TP4	1SNK900205R0000	20	2,40
	Dark grey	TP5	1SNK900206R0000	20	4,10
	Dark grey	TCS	1SNK900200R0000	10	5,20
7 Test connectors	Dark grey	TCS-R1	1SNK900201R0000	10	5,20
	Dark grey	SNBP	1SNK900601R0000	20	4,10
	Dark grey	SNBP	1SNK900601R0000	20	4,10
8 Shield connectors	White	MS-CRM	1SNB041750R0512	1960	0,23
	White	MCS12	1SNK140000R0000	22	9,00
	White	MCS12PA	1SNK149999R0000	20	10,00
	Grey	UMH	1SNK900611R0000	10	0,20

Complete list of accessories is indicated in the terminal block datasheet including end stops. Some accessories such as jumper bars may modify the terminal block's ratings. Complete information available in the accessories section of the catalog.

**Ground PI-Spring terminal blocks**

Description	Color	Type	Part Number	Pkg	Weight (1 post) g
Ground	Green-yellow	ZK2.5-FE	1SNK705150R0000	20	10,00

Technical data valid for copper conductors only.

Click on the product part number to obtain detailed information and agreements.

INDUSTRIAL /// ENTRELEC - SNK TERMINAL BLOCKS

15NK16009450201



## Videos

### SNK challenges

Discover how our SNK terminal blocks are able to overcome any kind of challenge!

What is the link between a terminal block, a washing machine, an egg and a child's play?  
Find it out quickly by watching our 6 episodes bellow.  
Get tips and experience moments of suspense and fun!



Episode 1

**Built for extreme conditions?**



Episode 2

**So fast to connect?**



Episode 3

**Available everywhere on time for everyone?**



Episode 4

**So efficient marking?**



Episode 5

**Common accessories for all technologies?**



Episode 6

**Mounting is a child's play?**

### SNK video



**SNK Series - The innovative range.**

The innovative SNK series is available in PI-Spring (Push-In and Spring), screw clamp and pluggable technologies with common accessories. Qualified for worldwide applications and severe environments such as hazardous locations, railways, marine and solar.

---

# SNK series, terminal blocks

## PI-Spring, screw clamp and pluggable technologies

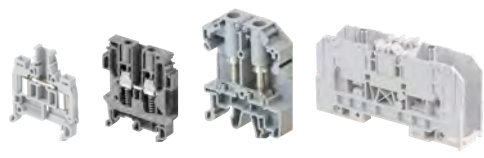
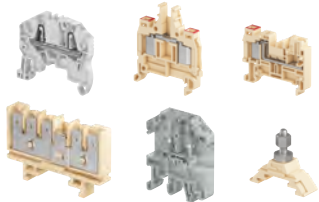

<u>Ranges and technologies presentation</u>	2	1
<u>PI-Spring terminal blocks</u>	13	2
<u>Screw clamp terminal blocks</u>	71	3
<u>Pluggable terminal blocks</u>	161	4
<u>Accessories</u>	195	5
<u>Marking solutions</u>	237	6
<u>Index</u>	270	7

TE Connectivity proposes one of the largest Din Rail Terminal block offering on the market with various technologies: screw, PI-Spring, spring, IDC, pluggable, stud, etc. found in over 8000 products & solutions.

	SNK terminal blocks		Dedicated applications terminal blocks		Terminal blocks for railway applications
					
<b>Scope</b>	Qualified for worldwide applications and severe environments (such as hazardous locations, railways, marine and solar applications..). From 0.2 to 300 mm <sup>2</sup> .		Specific terminal blocks and technologies for dedicated applications and markets.		The largest offering on the market for rolling stock and infrastructures.
<b>Product families &amp; functions</b>	<b>SNK PI-Spring technology</b> 2.5 to 16 mm <sup>2</sup> 12 to 4 AWG	Feed-through Multi-deck Ground Disconnect for fuses Component holder	<b>ADO System® (IDC)</b> 0.22 to 4 mm <sup>2</sup> 24 to 12 AWG	ADO-ADO or ADO-screw clamp Feed-through / Multi-deck / Ground / Disconnect / for fuses / Component holder	<b>SNK PI-Spring technology</b> 2.5 to 16 mm <sup>2</sup> 12 to 4 AWG
			<b>Safety (spring loaded)</b> 0.22 to 10 mm <sup>2</sup> 24 to 6 AWG	Feed-through Disconnect Test & measurement	<b>SNK pluggable screw &amp; PI-Spring technologies</b> 2.5 to 4 mm <sup>2</sup> 12 to 10 AWG
	<b>SNK screw clamp technology</b> 4 to 240 mm <sup>2</sup> 12 to 500 Kcmil	Feed-through Multi-deck Ground Disconnect for fuses Test & measurement Marshalling Component holder	<b>Stud</b> 25 to 300 mm <sup>2</sup> 4 AWG to 1000 Kcmil	One stud 2 studs One stud - One screw clamp	<b>ADO System® (IDC)</b> 1.5 to 4 mm <sup>2</sup> 16 to 12 AWG
			<b>Ring lug</b> 6 to 16 mm <sup>2</sup> 8 to 6 AWG	Feed-through Test & measurement	<b>Stud</b> 4 to 185 mm <sup>2</sup>
	<b>SNK pluggable screw &amp; PI-Spring technologies</b> 2.5 to 4 mm <sup>2</sup> 12 to 10 AWG	Feed-through Multi-deck Ground	<b>Miniblocks</b> 1.5 to 6 mm <sup>2</sup> 18 to 8 AWG	Screw clamp Spring ADO System® (IDC)	<b>Quick-connect</b> 2.5 to 6 mm <sup>2</sup>
		<b>Other types</b> Test & measurement: with sliding link, blade, plug Pluggable: feed-through, double deck, disconnect Sensors/actuators: screw, spring, ADO system (IDC) Installation: screw, spring Protection: ground + neutral Component holders: screw, spring, ADO system (IDC)			

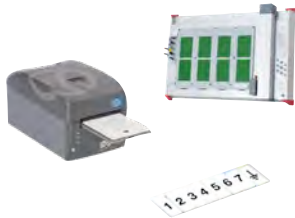

www.te.com

DBL power distribution blocks	ESSAILEC® test blocks	Interfast PLC pre-wiring system	Marking solutions
			
<p>The preferred choice for primary power distribution and solar applications.</p>	<p>Test blocks for safe and easy testing on secondary circuits of current and voltage transformers and sensors.</p>	<p>PLC pre-wiring system for fast, flexible, reliable connection of PLC's in process automation applications.</p>	<p>Markers &amp; marking systems for all identification requirements in electrical panels.</p>
<p>From 80 A up to 550 A (IEC)</p> <p>Modular blocks: single pole, three &amp; four poles, up to 12 outputs</p> <p>Terminal blocks types: 2 to 10 poles, up to 20 outputs</p>	<p>Current and voltage sockets &amp; plugs</p> <p>Simultaneous testing of 1 to 4 independent circuits on the same socket</p> <p>Several testing principle such as "make before break" for safe current transformer testing</p> <p>Panel and switchboard mounting : base, flush, rack, TH35 rail</p> <p>Multicircuits sockets &amp; plugs</p>	<p>Interfast PCB: Compact &amp; standard modules</p> <p>Interfast MS: Modular system based on terminal block technology</p> <p>Functions:</p> <ul style="list-style-type: none"> <li>- 1 to 4 wire connections (sensors)</li> <li>- Disconnect</li> <li>- Fuse</li> <li>- Signal indication</li> <li>- Relays</li> <li>- Optocouplers</li> <li>- Solenoid valve control</li> <li>- Galvanic isolation (2.5 kV).</li> </ul>	<p>Terminal block identification and group markers</p> <p>Wire and cable identification</p> <p>Component and equipment identification</p> <p>Panel identification</p> <p>Pre-printed markers for terminal blocks</p>





## SNK series, terminal blocks

PI-Spring, screw clamp and pluggable technologies

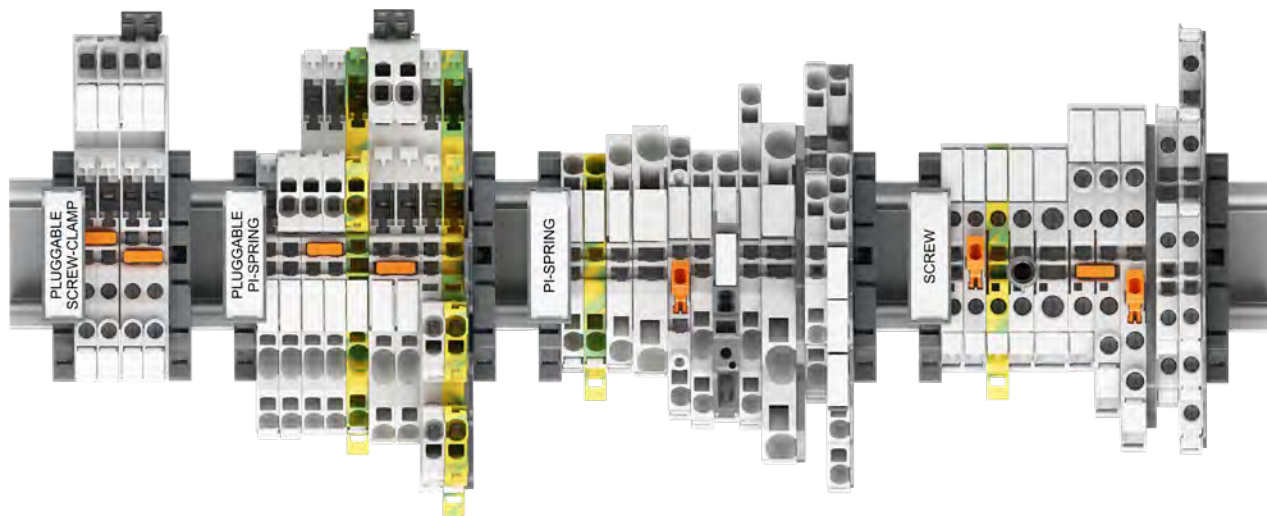

The innovative range available in PI-Spring (Push-In and Spring), screw clamp and pluggable technologies with common accessories.

Qualified for worldwide applications and severe environments such as hazardous locations, railways, marine and solar applications...



### Speed up your projects

#### Smart connections, higher productivity

Up to 90% mounting time reduction with our PI-Spring, screw clamp and pluggable technologies.

#### Simplified selection and design

Intuitive codification, simplified catalogs, large technical data base.

#### Better project identification

20% larger marking area.

Pre-mark by hand or label before final marker installation.



### Easy to install

#### Secured installation

Asymmetrical design avoid mounting and wiring errors. Zero-retightening with our technologies.

#### Faster accessories mounting

Benefit from screwless ground connection, jumpers, end stops.

#### Smart design facilitating assembly process

Mounting, wiring, testing... made easy.



### Optimized logistics

#### 50% less accessories needed

End sections, circuit separators fit several blocks.

#### Common accessories

PI-Spring, screw and pluggable ranges share the same accessories.

#### Simplified inventory management

Significant reduction of part numbers to manage.

## PI-Spring technology

### Two technologies in one connection

The patented design of TE Connectivity's PI-Spring can be used as a Push-in or traditional spring connection: Push-in and spring. The Push-in mode allows a direct one-step insertion of solid and flexible stranded wires with a ferrule, 50% faster than standard screw clamp technology.

Using the spring mode, very little effort is required to open the spring clamp with a screwdriver and insert the wire, which does not need a ferrule. The screwdriver locks in the terminal block after insertion, freeing up hands to manipulate wires or circuit drawings.

## Features

All certification testing performed with non prepared wires, ensuring perfect connections with or without ferrules

Flat surface of the PI-Spring makes wire and screwdriver insertion smoother and easier

Dimensions, coating and shape of the linking bar designed to get the lowest and most stable electrical contact value

Very good electrical contact even in applications where vibration and shock are an issue, such as railway

Connection elasticity and design strictly controlled to ensure an easy and safe insertion of both conductor and screwdriver

The PI-Spring technology has successfully passed aging tests (30 days temperature rise test and 14 days heat cycling test) guaranteeing the perfect long-term contact quality of our screwless technology

Excellent pulling strength exceeding IEC standard requirements

Stainless steel PI-Spring for high corrosion resistance up to 1,000 hours salt mist resistance



From 0.2 mm<sup>2</sup> up to 16 mm<sup>2</sup>

From 26 AWG up to 4 AWG

# Screw clamp technology

## The heavy duty connection

### Unique design, flies over time thanks to its reliability and safety

The TE Connectivity screw clamp technology is designed to avoid accidental releases due to vibrations, shocks or even abusive cable draw.

### High density capacity

The screw clamp technology can fit up to two conductors per clamp which offers extended possibilities in electrical cabinets.

## Features

The clamp is punched, which increases the number of screw threads by 30% meaning a high torque resistance

The TE Connectivity exclusive anti-release system creates a controlled locking-screw effect thanks to the 2 overlapping tabs that maintain the clamp parts. The screw is locked in total safety. The retightening campaigns are not needed anymore!

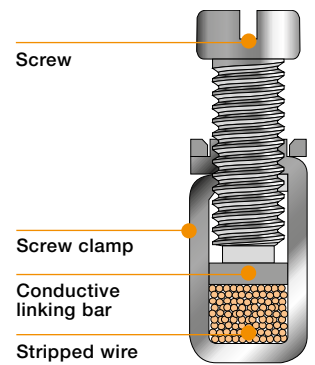
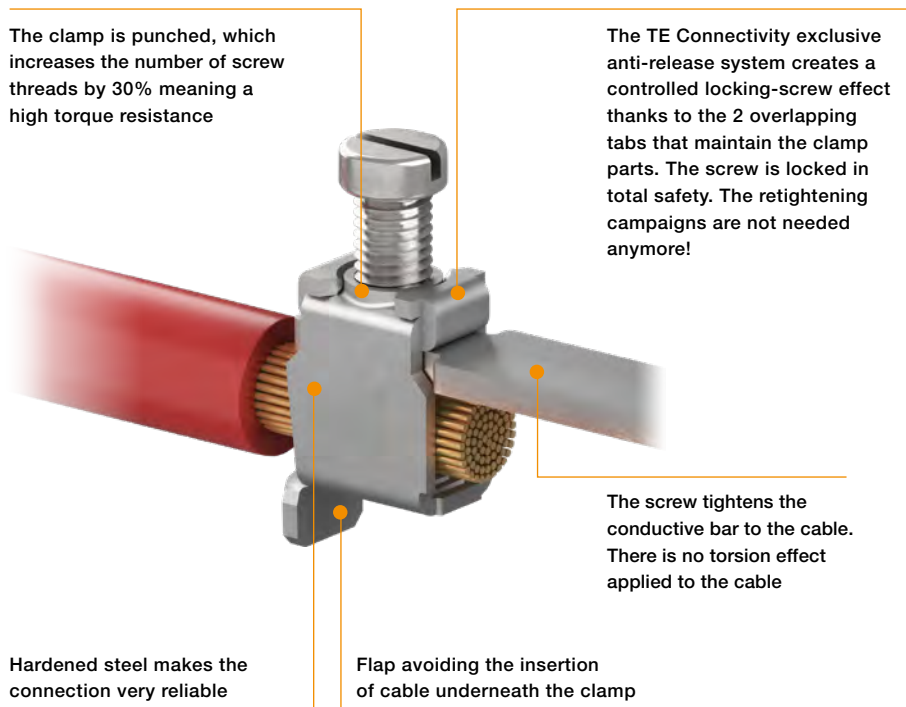

Hardened steel makes the connection very reliable

Flap avoiding the insertion of cable underneath the clamp

The screw tightens the conductive bar to the cable. There is no torsion effect applied to the cable

From 0.2 mm<sup>2</sup> up to 240 mm<sup>2</sup>

From 24 AWG up to 500 Kcmil

## Pluggable technology

The pluggable technology allows "plug and play" connection. It enables productivity savings, wiring optimization thanks to serialized pre-wired plugs harnesses, as well as secured final commissioning.

### Features

The TE Connectivity plug is the most compact on the market thanks to the punched U-shaped linking bar allowing direct conductor contact. TE Connectivity Patented design!

The lyres are made of copper alloy in order to offer maximized mechanical elasticity resistance (superior to 50 matings/unmatings)

The TE Connectivity pluggable terminal blocks have successfully performed the marine environmental tests and meet the most severe rolling stock requirements in 3 axis vibrations and shock resistance (for PI-Spring pluggable terminal blocks versions)

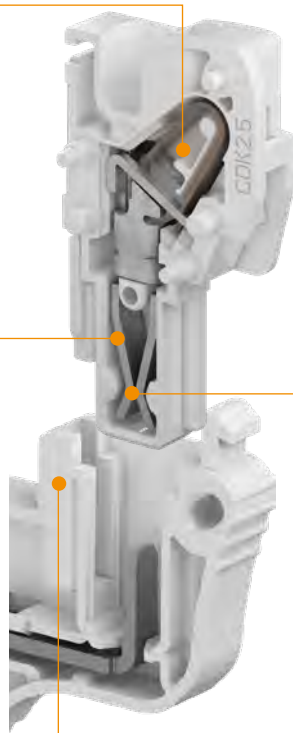

The chamfer shape guarantees auto-centering and mechanical integrity of the plug when inserted into the pluggable terminal block

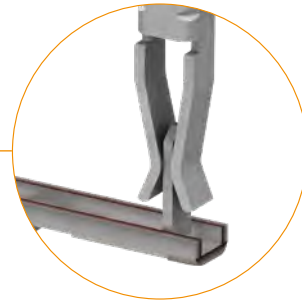

From 0.2 mm<sup>2</sup> up to 4 mm<sup>2</sup>

From 26 AWG up to 10 AWG



## SNK series, terminal blocks

### Applications

Qualified for worldwide markets, applications and for severe environments: vibration, shock, corrosion...

#### Industry and Commercial



SNK series, terminal blocks can be used worldwide in all types of industrial and commercial applications. All our products have CB, UL and CSA third party certificates delivered by independent laboratories. SNK series products are developed and qualified in accordance with the following international standards:  
IEC 60947-1, IEC 60947-7-1, IEC 60947-7-2, IEC 60947-7-3, UL 1059, CSA C22.2 n°158-10.



#### Solar



Thanks to their high voltage rating (up to 1500 VDC per IEC 60947-7-1 and 1000 VDC per UL 1059), SNK terminal blocks are ideally suited for use in solar equipment.

#### Waste and Water



SNK terminal blocks are well adapted to harsh environment conditions such as waste and water applications. They have successfully passed the salt mist test in accordance with IEC 60068-2-11 (PI-Spring withstand up to >1000 h). SNK terminal blocks are also compliant with flowing mixed gas corrosion test per IEC 60068-2-60 (test duration: 21 days).



## Railways



All SNK series products are suited to track-side fixed equipment.

For the more demanding environment of rolling stock applications, PI-Spring has been successfully tested in accordance with IEC 61373 requirements to resist high vibration and shock conditions (multi-axial waves, acceleration...).

The plastic material used is compliant with the flammability, smoke toxicity and opacity severe requirements of the traction segment and can be classified I2F2 per NF F 16-101 and NF F 16-102 standards; HL3 R22 per EN 45 545 standard and V0 per UL94 standard.

It complies with NFPA 130 per ASTM E 162 and ASTM E 662 standards tests and with FR238.103 and BSS 7239 standards.

## Hazardous locations



SNK series is certified IEC Ex in accordance with IEC 60079-0 and IEC 60079-7 (increased safety "Exe") world international standards for products used in explosive atmospheres.

In order to serve specific local market requirements, some SNK products have additional local certifications such as: ATEX, UL hazardous Locations...

SNK products have successfully passed toughest tests like the thermal endurance test: 2 weeks in hot environment at 95 °C (+90% RH) followed by 2 weeks at 125 °C and one day cold environment test (-65 °C). This proves the high mechanical performances of the SNK products.



## Marine



SNK products have proven their performance by successfully passing tests required for the most extreme conditions. (eg: salt mist, damp or dry heat and cold environments) per IEC 60068 standards.

In order to serve the worldwide marine markets requirements, SNK products have the following Marine certifications: BV Marine, DNV, RINA, RMRS.



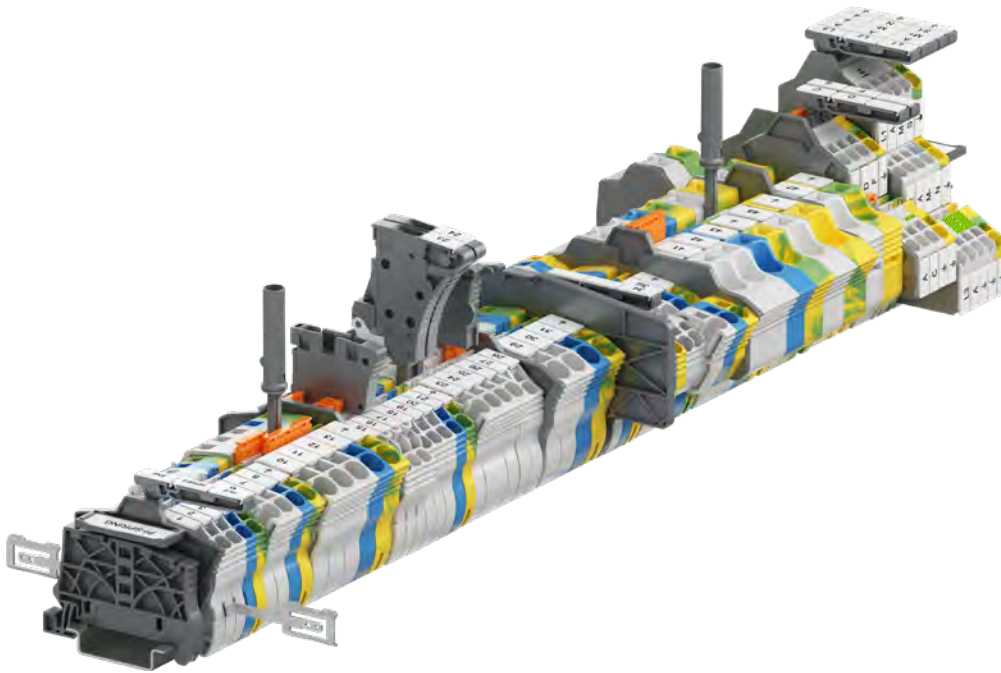

# SNK series, terminal blocks

## PI-Spring technology

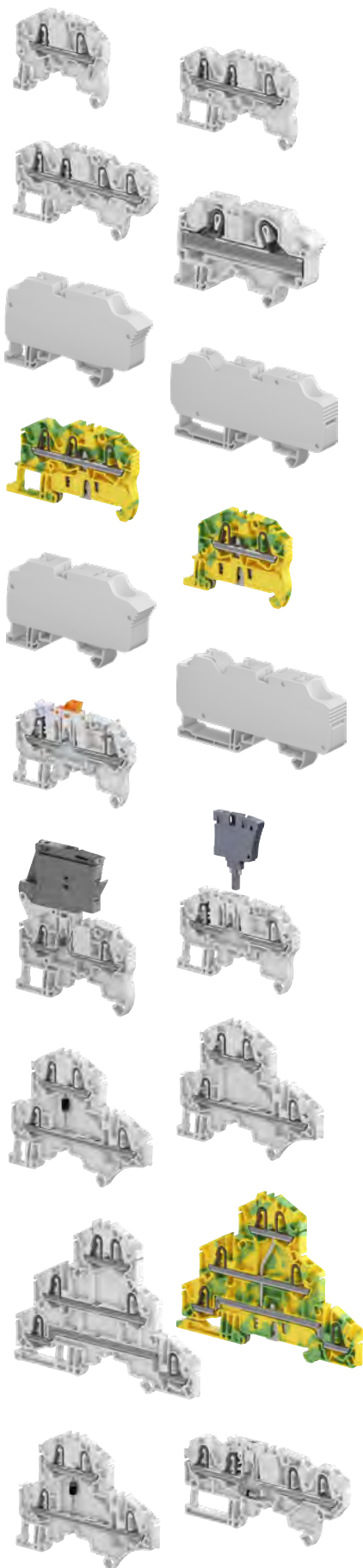

Technologies presentation		14
Overview		20
<b>Feed-through</b>		
2.5 mm <sup>2</sup> / 12 AWG	<b>ZK2.5</b>	21
	<b>ZK2.5-3P</b>	with 3 connections 22
	<b>ZK2.5-4P</b>	with 4 connections 23
4 mm <sup>2</sup> / 10 AWG	<b>ZK4</b>	24
	<b>ZK4-3P</b>	with 3 connections 25
	<b>ZK4-4P</b>	with 4 connections 26
6 mm <sup>2</sup> / 8 AWG	<b>ZK6</b>	27
	<b>ZK6-3P</b>	with 3 connections 28
10 mm <sup>2</sup> / 6 AWG	<b>ZK10</b>	29
	<b>ZK10-PV</b>	30
	<b>ZK10-3P</b>	with 3 connections 31
	<b>ZK10-3P-PV</b>	with 3 connections 32
16 mm <sup>2</sup> / 4 AWG	<b>ZK16</b>	33
	<b>ZK16-PV</b>	34
	<b>ZK16-3P</b>	with 3 connections 35
	<b>ZK16-3P-PV</b>	with 3 connections 36
<b>Ground</b>		
2.5 mm <sup>2</sup> / 12 AWG	<b>ZK2.5-PE</b>	37
	<b>ZK2.5-PE-3P</b>	with 3 connections 38
	<b>ZP2.5-PE-4P</b>	with 4 connections 39
4 mm <sup>2</sup> / 10 AWG	<b>ZK4-PE</b>	40
	<b>ZK4-PE-3P</b>	with 3 connections 41
	<b>ZK4-PE-4P</b>	with 4 connections 42
6 mm <sup>2</sup> / 8 AWG	<b>ZK6-PE</b>	43
	<b>ZK6-PE-3P</b>	with 3 connections 44
10 mm <sup>2</sup> / 6 AWG	<b>ZK10-PE</b>	45
	<b>ZK10-PE-3P</b>	with 3 connections 46
16 mm <sup>2</sup> / 4 AWG	<b>ZK16-PE</b>	47
	<b>ZK16-PE-3P</b>	with 3 connections 48
<b>Disconnect with blade</b>		
2.5 mm <sup>2</sup> / 12 AWG	<b>ZK2.5-S</b>	with test sockets 49
	<b>ZK2.5-S-4P</b>	with test sockets 50
	<b>ZK2.5-S-R1</b>	51
<b>Disconnect with plug</b>		
2.5 mm <sup>2</sup> / 12 AWG	<b>ZK2.5-SP</b>	with test sockets 52
	<b>ZK2.5-SP-4P</b>	with test sockets 53
<b>For 5x20 fuses</b>		
2.5 mm <sup>2</sup> / 12 AWG	<b>ZK2.5-SF</b>	54
	<b>ZK2.5-SF-R</b>	with blown fuse indicator 55
<b>Double deck</b>		
2.5 mm <sup>2</sup> / 12 AWG	<b>ZK2.5-D2</b>	2 feed-through circuits 56
	<b>ZK2.5-D1</b>	1 feed-through circuit 57
	<b>ZK2.5-D2-PE</b>	1 feed-through circuit and 1 ground circuit 58
	<b>ZK2.5-D1-PE</b>	1 ground circuit 59
<b>Triple deck</b>		
2.5 mm <sup>2</sup> / 12 AWG	<b>ZK2.5-T3</b>	3 feed-through circuits 60
	<b>ZK2.5-T1</b>	1 feed-through circuit 61
	<b>ZK2.5-L-L-PE</b>	62
	<b>ZK2.5-L-N-PE</b>	2 feed-through circuits and 1 ground circuit 63
	<b>ZK2.5-T1-PE</b>	1 ground circuit 64
<b>Component holder</b>		
2.5 mm <sup>2</sup> / 12 AWG	<b>ZK2.5-CH-4P-LR</b>	65
	<b>ZK2.5-CH-4P-RL</b>	66
	<b>ZK2.5-D-CH-UD</b>	67
	<b>ZK2.5-D-CH-DU</b>	68
	<b>ZK2.5-D-CH2-DU-RL</b>	69

## PI-Spring technology - SNK series, terminal blocks

### Features and benefits

The patented PI-Spring technology provides the benefits of both Push-In and Spring technologies in one connection



### Speed up your projects

#### 50% faster connection time with Push-in mode

Our Push-in connection technology allows:  
A direct one step insertion with rigid and prepared flexible conductors.  
Easy and quick insertion of the prepared flexible conductor or rigid conductor.

#### Reduced effort and conductor preparation time with spring mode

- Our connection requires minimal effort to insert wires with the screwdriver
- Flexible conductors preparation is not necessary.
- The screwdriver locks onto terminal freeing up hands.

#### Better project identification

- Circuit identification is improved thanks to the 20% larger marking area
- Pre-mark by hand or with label on our flat marking surface and start immediately the wiring, before the final markers mounting
- Spare markers re-printing in case of modifications.



Push-in mode

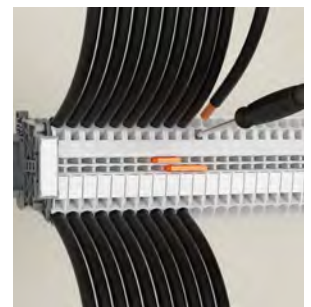

Spring mode

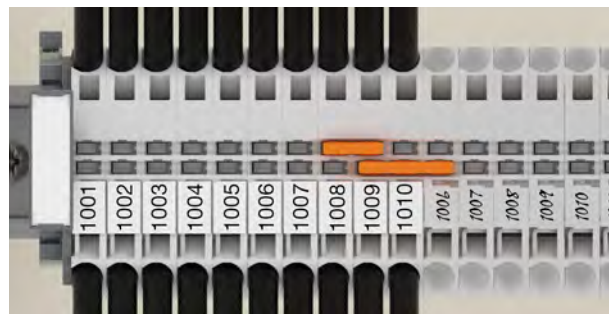

Clear circuit identification

1SNK162074S0201

## PI-Spring technology - SNK series, terminal blocks

### Features and benefits

#### Easy to install

##### Smart design facilitating assembly process

Mounting, wiring, testing... made easy

Avoid mounting and wiring errors: asymmetrical design allows immediate visual check in case of reversed terminal blocks.



Asymmetrical design avoids mounting error

##### Faster accessories mounting

Save up to 70% mounting time thanks to :

- screwless jumpers, component plugs, test devices, end stops and snap-in ground terminal blocks.



Screwless accessories

Snap-in ground terminal blocks

Closed jumper location allows great stiffness of the terminal block, avoid deflection while tightening and optimal jumper guiding.

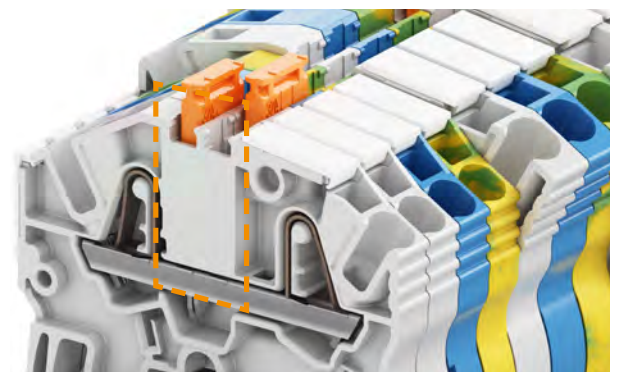

Closed jumper location for stiffness.



# PI-Spring technology - SNK series, terminal blocks

## Features and benefits

### Easy to install

#### Smart accessories

Flexible test solutions from individual insulated test adapter to test connectors for complete assemblies testing.

- Direct plug-in into jumpers channels
- 5, 6, 8 mm spacing, mixing various spacing is possible
- 1000 V rating.



Plug-in individual test adapter.

Plug-in test connector.

Component holder plugs for series or parallel component mounting (resistors, filters, diodes...).

Can be installed after wiring.

Series plug offers screwless component connection (no soldering).

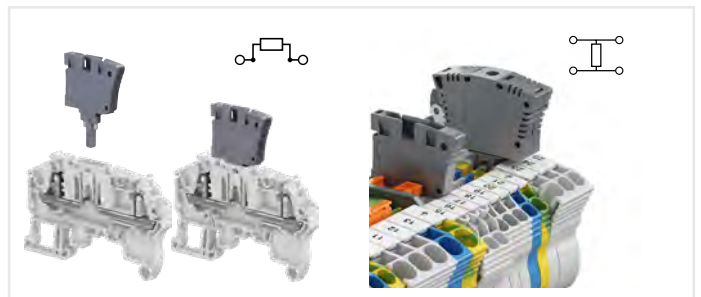

Series plug associated with disconnect blocks.

Parallel plug to be installed between 2 blocks.

#### Smart plug-in jumpers:

Pre-cut poles removable by hand: clean cut.

Insulated up to 1000 V (avoid use of separators).

Predefined shapes in molding to easily identify connected poles with a pen.

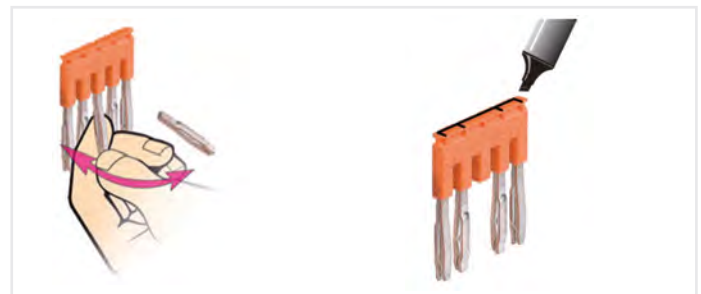

Pre-cut poles easy removable by hand.

Predefined shape to identify connected poles.



# PI-Spring technology - SNK series, terminal blocks

## Features and benefits

### Optimized logistics

#### Reduce your accessories inventory by up to 50%

SNK PI-Spring, screw and pluggable ranges share the same accessories.

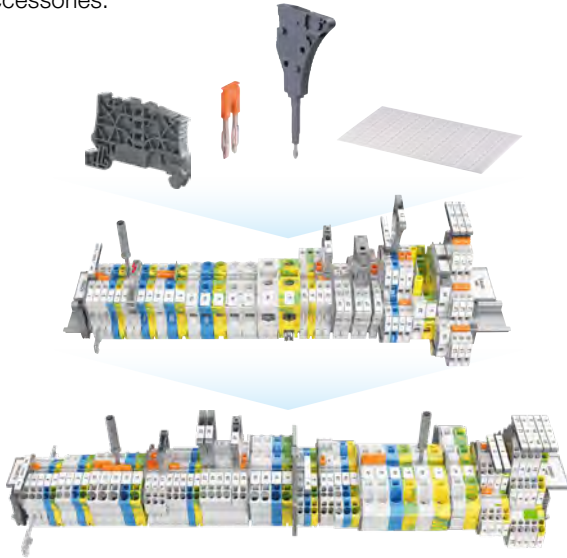

Shared accessories for SNK PI-Spring, screw and pluggable ranges

- All end sections and circuit separators fit several types and sizes of blocks
- One end section fits up to 21 models
- One circuit separator fits with 62 terminal blocks.



End sections and circuit separators fit several types and sizes of blocks

#### 50% less inventory makes PI-Spring attractive to all worldwide markets

- The user selects one range but benefit from 2 connection modes (push-in and spring) which have global certifications and access to markets and applications worldwide
- Reduced packaging adapted to the usage (20 items packaging on some items).

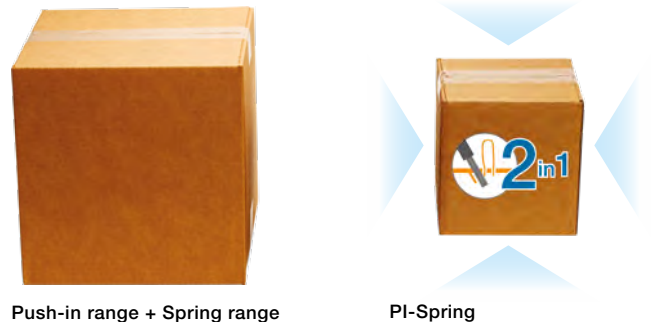

Push-in range + Spring range

PI-Spring

### Facilitate maintenance operations

Terminal blocks can be individually removed from a terminal assembly equipped with markers: TE Connectivity markers become independent after strip mounting. The markers remain on terminal in any situation.

Markers are interchangeable: the smaller marker can fit any bigger block.



Maintenance operations facilitated

### Reliable in harsh conditions

Qualified for worldwide markets, applications and for severe environments: vibration, shock, corrosion...

### High corrosion resistance

PI-Spring clamp is made of high quality stainless steel. Salt mist withstand up to 1,000 hours (as per IEC 60068).



## SNK series, terminal blocks

PI-Spring technology - Range overview from 2.5 to 16 mm<sup>2</sup> - 12 to 4 AWG

### 2 Connections

#### Single deck

Feed-through  
Ground  
Disconnect  
Fuse  
Solar : 1500 VDC

**NEW**

### 3 Connections

#### Single deck

Feed-through  
Ground  
Solar: 1500 VDC

**NEW**

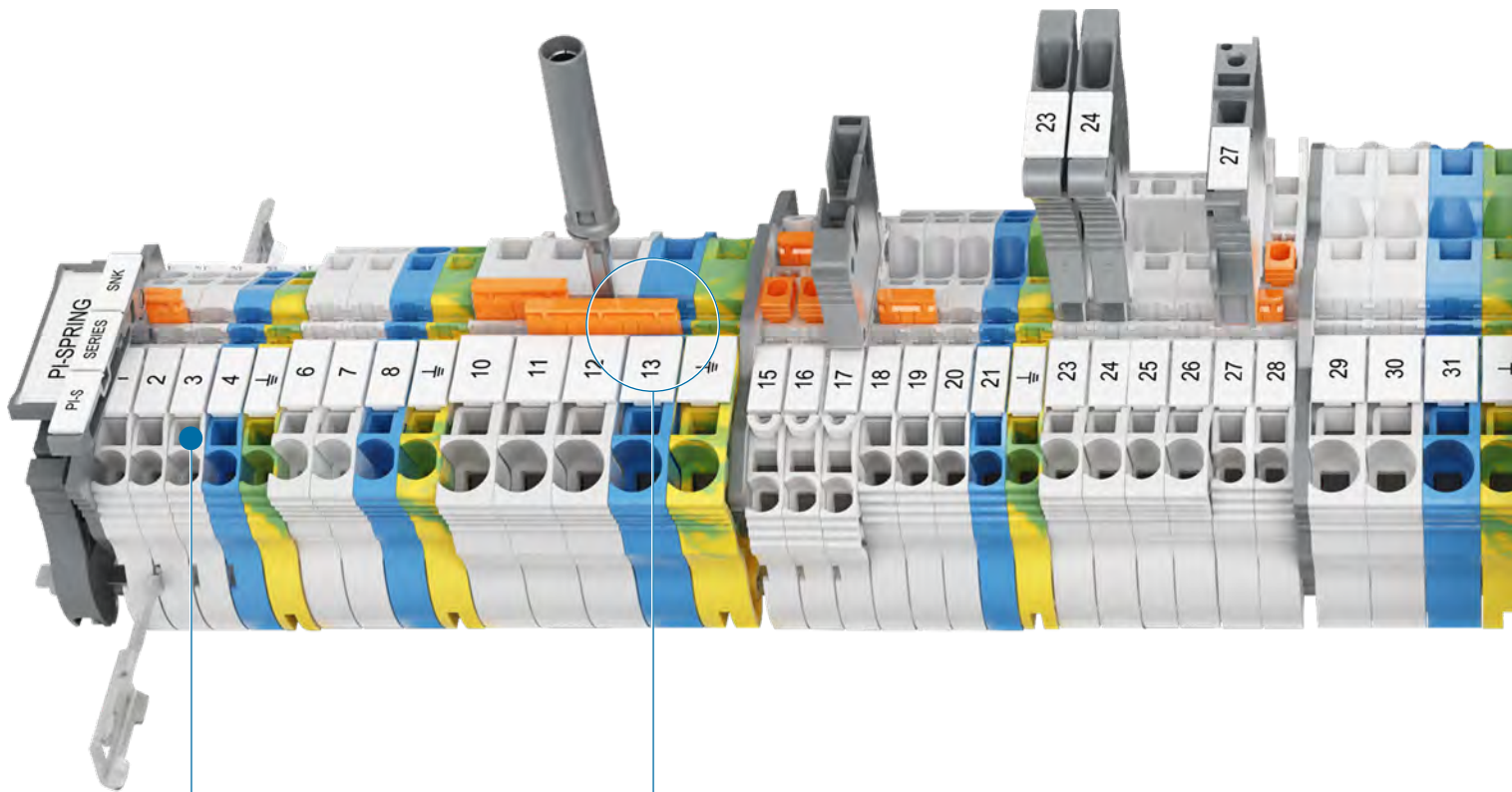

#### Voltage test

screwdriver entry  
point accepts  
Category II probes

#### Double central channels

allows multiconfigurations  
(jumping, testing and measuring)

4

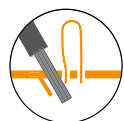

Connections

**Single deck**

Feed-through  
Ground  
Disconnect  
Component holder

2x2



Connections

**Double deck**

Feed-through  
Ground  
Component holder

3x2



Connections

**Triple deck**

Feed-through  
Ground



**Two circuit separators**  
for the entire range

**End section**  
can be used  
as circuit separator

**Rotating label holder**  
easy plug-in in  
jumper channel

# SNK series, terminal blocks

## PI-Spring technology

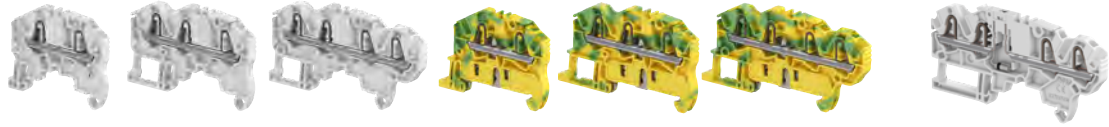

		Feed-through			Ground			Component holder	
Section									
2.5 mm <sup>2</sup>	12 AWG	ZK2.5	ZK2.5-3P	ZK2.5-4P	ZK2.5-PE	ZK2.5-PE-3P	ZK2.5-PE 4P	ZK2.5-CH-4P-LR	ZK2.5-CH-4P-RL
4 mm <sup>2</sup>	10 AWG	ZK4	ZK4-3P	ZK4-4P	ZK4-PE	ZK4-PE-3P	ZK4-PE- 4P		
6 mm <sup>2</sup>	8 AWG	ZK6	ZK6-3P		ZK6-PE	ZK6-PE-3P			
10 mm <sup>2</sup>	6 AWG	ZK10	ZK10-3P		ZK10-PE	ZK10-PE-3P			
16 mm <sup>2</sup>	4 AWG	ZK10-PV <b>New</b>	ZK10-3P-PV						
		ZK16	ZK16-3P		ZK16-PE	ZK16-PE-3P			
		ZK16-PV <b>New</b>	ZK16-3P-PV						

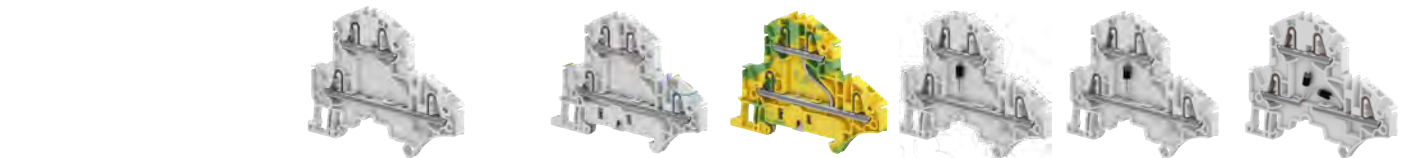

		Feed-through		Ground		Component holder		
Section								
2.5 mm <sup>2</sup>	12 AWG	ZK2.5-D2	ZK2.5-D1	ZK2.5-D2-PE	ZK2.5-D1-PE	ZK2.5-D-CH-UD	ZK2.5-D-CH-DU	ZK2.5-D-CH2-DU-RL



		Feed-through		Ground	
Section					
2.5 mm <sup>2</sup>	12 AWG	ZK2.5-T3	ZK2.5-T1	ZK2.5-L-L-PE ZK2.5-L-N-PE	ZK2.5-T1-PE

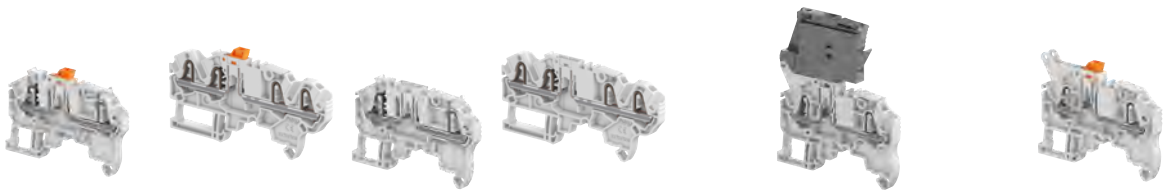

		With blade		With plug		For 5x20 mm fuses		Aligned with ZK2.5-SF
Section								
2.5 mm <sup>2</sup>	12 AWG	ZK2.5-S	ZK2.5-S-4P	ZK2.5-SP	ZK2.5-SP-4P	ZK2.5-SF	ZK2.5-SF-R1 ZK2.5-SF-R3	ZK2.5-S-R1

Clamp - 
 Channels for jumpering or testing - 
 Test socket - 
 Blown-fuse indicator

1SNK162020S0201 - Rev. B



# ZK2.5 PI-Spring terminal blocks

## Feed-through - 5.2 mm 0.205 in spacing



ZK2.5

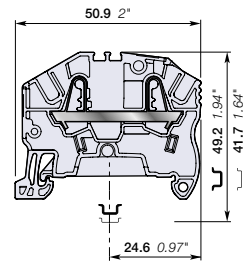

5.2 mm 0.205 in spacing

### Description

Combine high performance with compact dimensions:

- 1000 V AC / DC IEC 600 V UL,
- Opt for the best marking visibility thanks to the up-front, flat marker zone, which lets you mark up to eight digits or increase the font size.

### Ordering details

Description	Color	Type	Part Number	Pkg qty	Weight (1 pce) g
Feed-through 2 connections	Grey	ZK2.5	1SNK705010R0000	50	5.50
	Blue	ZK2.5-BL	1SNK705020R0000	50	5.50
	Orange	ZK2.5-OR	1SNK705030R0000	50	5.50
	Yellow	ZK2.5-YL	1SNK705060R0000	50	5.50
	Green	ZK2.5-GN	1SNK705061R0000	50	5.50
	Red	ZK2.5-RD	1SNK705062R0000	50	5.50
	White	ZK2.5-WH	1SNK705065R0000	50	5.50
	Black	ZK2.5-BK	1SNK705066R0000	50	5.50

### Main technical data

Connecting capacity	IEC	UL - CSA	Mounting instructions
1 conductor per clamp	Rigid: Solid/Stranded	0.2 ... 4 mm <sup>2</sup>	26 ... 12 AWG
	Flexible without ferrule	0.22 ... 2.5 mm <sup>2</sup>	26 ... 14 AWG
	Flexible with non insulated ferrule	0.22 ... 2.5 mm <sup>2</sup>	26 ... 14 AWG
	Flexible with insulated ferrule	0.22 ... 2.5 mm <sup>2</sup>	26 ... 14 AWG
2 conductors per clamp	Flexible with twin ferrule	0.22 ... 0.5 mm <sup>2</sup>	26 ... 20 AWG
Rated current / Rated cross section		24 A / 2.5 mm <sup>2</sup>	20 A / 12 AWG
Rated short-time withstand current (1s)		300 A	396 A
Short Circuit Current Rating (with specific conditions)			100 kA
Rated voltage		1000 V	600 V
Impulse withstand voltage		8000 V	
Protection		IP20	NEMA 1
Increased safety Ex e		693 V 21 A IEC/EN 60079-7 - IM2 II 2 GD Ex eb I/II/III/C	

The connecting capacity data for one Rigid: Solid/Stranded, or one Flexible conductor (when applicable) is a mandatory information required by IEC, UL and CSA standards (Copper conductors). All other data are provided as supplementary information only. For more details, please consult our CB, UL or CSA certificates and technical datasheet available on <http://www.TE.com>



### Accessories

Description	Color	Type	Part Number	Pkg qty	Weight (1 pce) g	
1 End stops	Dark grey	BAZ1	1SNK900002R0000	50	5.30	
2 End sections	Dark grey	EK2.5	1SNK705910R0000	20	1.80	
3 Jumper bars	Orange	2 poles	JB5-2	1SNK905302R0000	50	1.30
		3 poles	JB5-3	1SNK905303R0000	50	2.00
		4 poles	JB5-4	1SNK905304R0000	50	2.70
		5 poles	JB5-5	1SNK905305R0000	50	3.50
		10 poles	JB5-10	1SNK905310R0000	30	7.10
		50 poles	JB5-50	1SNK905350R0000	10	36.00
4 Cross spacing jumpers	Orange	JB85-3	1SNK900603R0000	10	2.80	
5 Circuit separators	Dark grey	CS-R2	1SNK900106R0000	20	3.80	
6 Test adapters	Dark grey	For test plugs DIA 2 mm 0.079 in	TP2	1SNK900203R0000	20	1.70
		For test plugs DIA 4 mm 0.157 in	TP4	1SNK900205R0000	20	2.40
7 Test connectors	Dark grey	5.2 mm 0.205 in spacing	TC5	1SNK900200R0000	10	5.20
		End module, 5.2 mm 0.205 in	TC5-R1	1SNK900201R0000	10	5.20
8 Shield connectors		SHBP	1SNK900601R0000	20	4.10	
9 Terminal block markers	White	Blank marker	MG-CPM 13 41790	1SNB041790R0512	1960	0.23
		Blank card	MC512	1SNK140000R0000	22	9.00
			MC512PA	1SNK149999R0000	20	10.00
		Universal wire markers holder	Grey	UMH	1SNK900611R0000	10

Complete list of accessories is indicated in the terminal block datasheet including end stops.

Some accessories such as jumper bars may modify the terminal block's ratings: Complete information available in the accessories section of the catalog.

### Ground PI-Spring terminal blocks

Description	Color	Type	Part Number	Pkg qty	Weight (1 pce) g
Ground	Green-yellow	ZK2.5-PE	1SNK705150R0000	20	10.00

Technical data valid for copper conductors only.

# ZK2.5-3P PI-Spring terminal blocks

Feed-through with 3 connections - 5.2 mm 0.205 in spacing

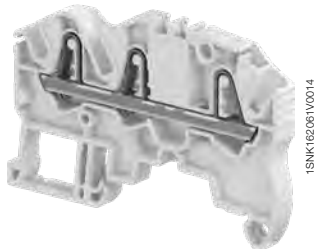

ZK2.5-3P

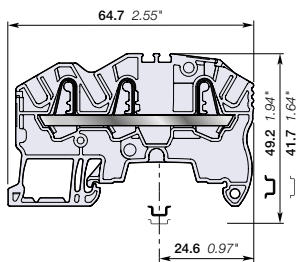

5.2 mm 0.205 in spacing

## Description

Find all the features of the ZK2.5 terminal block with the added option of distributing or branching 3 conductors.

## Ordering details

Description	Color	Type	Part Number	Pkg qty	Weight (1 pce) g
Feed-through 3 connections	Grey	ZK2.5-3P	1SNK705011R0000	50	7.40
	Blue	ZK2.5-3P-BL	1SNK705021R0000	50	7.40
	Orange	ZK2.5-3P-OR	1SNK705031R0000	50	7.40
	Yellow	ZK2.5-3P-YL	1SNK705067R0000	50	7.40
	Green	ZK2.5-3P-GN	1SNK705068R0000	50	7.40
	Red	ZK2.5-3P-RD	1SNK705069R0000	50	7.40
	White	ZK2.5-3P-WH	1SNK705072R0000	50	7.40
	Black	ZK2.5-3P-BK	1SNK705073R0000	50	7.40

## Main technical data

Connecting capacity	IEC	UL - CSA	Rail	Wire stripping length	TH 35-7.5, TH 35-15
1 conductor per clamp	Rigid: Solid/Stranded	0.2 ... 4 mm <sup>2</sup>	26 ... 12 AWG	11 mm	0.433 in
	Flexible without ferrule	0.22 ... 2.5 mm <sup>2</sup>			
	Flexible with non insulated ferrule	0.22 ... 2.5 mm <sup>2</sup>	26 ... 14 AWG		
	Flexible with insulated ferrule	0.22 ... 2.5 mm <sup>2</sup>	26 ... 14 AWG		
2 conductors per clamp	Flexible with twin ferrule	0.22 ... 0.5 mm <sup>2</sup>	26 ... 20 AWG	Tool (for flexible conductor without ferrule)	Flat screwdriver Ø 3.5 mm Ø 0.138 in
<b>Rated current / Rated cross section</b>		24 A / 2.5 mm <sup>2</sup>	20 A / 12 AWG		
<b>Rated short-time withstand current (1s)</b>		300 A	396 A		
<b>Short Circuit Current Rating (with specific conditions)</b>			100 kA		
<b>Rated voltage</b>		1000 V	600 V		
<b>Impulse withstand voltage</b>		8000 V			
<b>Protection</b>		IP20	NEMA 1		
<b>Increased safety Ex e</b>		693 V 21 A IEC/EN 60079-7 - IM2 II 2 GD Ex eb IIC/IIC			

The connecting capacity data for one Rigid: Solid/Stranded, or one Flexible conductor (when applicable) is a mandatory information required by IEC, UL and CSA standards (Copper conductors). All other data are provided as supplementary information only. For more details, please consult our CB, UL or CSA certificates and technical datasheet available on <http://www.TE.com>



## Accessories

Description	Color	Type	Part Number	Pkg qty	Weight (1 pce) g	
1 End stops	Dark grey	BAZ1	1SNK900002R0000	50	5.30	
2 End sections	Dark grey	EK2.5-3P	1SNK705911R0000	20	2.40	
3 Jumper bars	Orange	2 poles	JB5-2	1SNK905302R0000	50	1.30
		3 poles	JB5-3	1SNK905303R0000	50	2.00
		4 poles	JB5-4	1SNK905304R0000	50	2.70
		5 poles	JB5-5	1SNK905305R0000	50	3.50
		10 poles	JB5-10	1SNK905310R0000	30	7.10
4 Cross spacing jumpers	Orange	JB85-3	1SNK900603R0000	10	2.80	
5 Circuit separators	Dark grey	CS-R3	1SNK900107R0000	20	6.40	
6 Test adapters	Dark grey	For test plugs DIA 2 mm 0.079 in	TP2	1SNK900203R0000	20	1.70
		For test plugs DIA 4 mm 0.157 in	TP4	1SNK900205R0000	20	2.40
7 Test connectors	Dark grey	5.2 mm 0.205 in spacing	TC5	1SNK900200R0000	10	5.20
		End module, 5.2 mm 0.205 in	TC5-R1	1SNK900201R0000	10	5.20
8 Terminal block markers	White	Blank marker	MG-CPM 13 41790	1SNB041790R0512	1960	0.23
		Blank card	MC512	1SNK140000R0000	22	9.00
			MC512PA	1SNK149999R0000	20	10.00
	Universal wire markers holder	Grey	UMH	1SNK900611R0000	10	0.20

Complete list of accessories is indicated in the terminal block datasheet including end stops. Some accessories such as jumper bars may modify the terminal block's ratings: Complete information available in the accessories section of the catalog.

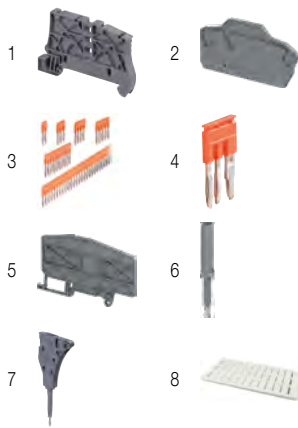

## Ground PI-Spring terminal blocks

Description	Color	Type	Part Number	Pkg qty	Weight (1 pce) g
Ground	Green-yellow	ZK2.5-PE-3P	1SNK705151R0000	20	11.90

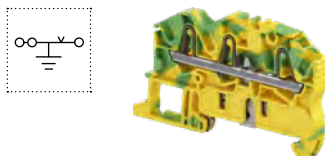

Technical data valid for copper conductors only.



# ZK2.5-4P PI-Spring terminal blocks

Feed-through with 4 connections - 5.2 mm 0.205 in spacing

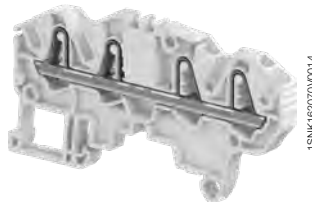

ZK2.5-4P

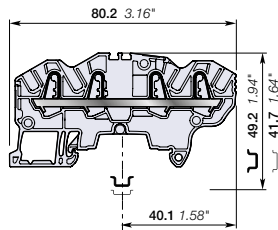

5.2 mm 0.205 in spacing

## Description

Find all the features of the ZK2.5 terminal block with the added option of distributing or branching 4 conductors.

## Ordering details

Description	Color	Type	Part Number	Pkg qty	Weight (1 pce) g
Feed-through 4 connections	Grey	ZK2.5-4P	1SNK705012R0000	50	9.00
	Blue	ZK2.5-4P-BL	1SNK705022R0000	50	9.00
	Orange	ZK2.5-4P-OR	1SNK705032R0000	50	9.00
	Yellow	ZK2.5-4P-YL	1SNK705074R0000	50	9.00
	Green	ZK2.5-4P-GN	1SNK705075R0000	50	9.00
	Red	ZK2.5-4P-RD	1SNK705076R0000	50	9.00
	White	ZK2.5-4P-WH	1SNK705079R0000	50	9.00
	Black	ZK2.5-4P-BK	1SNK705080R0000	50	9.00

## Main technical data

Connecting capacity	IEC	UL - CSA	Mounting instructions
<b>1 conductor per clamp</b>	Rigid: Solid/Stranded Flexible without ferrule Flexible with non insulated ferrule Flexible with insulated ferrule	0.2 ... 4 mm <sup>2</sup> 0.22 ... 2.5 mm <sup>2</sup> 0.22 ... 2.5 mm <sup>2</sup> 0.22 ... 2.5 mm <sup>2</sup>	26 ... 12 AWG 26 ... 14 AWG 26 ... 14 AWG
<b>2 conductors per clamp</b>	Flexible with twin ferrule	0.22 ... 0.5 mm <sup>2</sup>	26 ... 20 AWG
<b>Rated current / Rated cross section</b>	24 A / 2.5 mm <sup>2</sup>	20 A / 12 AWG	
<b>Rated short-time withstand current (1s)</b>	300 A	396 A	
<b>Short Circuit Current Rating (with specific conditions)</b>		100 kA	
<b>Rated voltage</b>	1000 V	600 V	
<b>Impulse withstand voltage</b>	8000 V		
<b>Protection</b>	IP20	NEMA 1	
<b>Increased safety Ex e</b>	693 V 21 A IEC/EN 60079-7 - IM2 II 2 GD Ex eb I/IC/IIIC		

The connecting capacity data for one Rigid: Solid/Stranded, or one Flexible conductor (when applicable) is a mandatory information required by IEC, UL and CSA standards (Copper conductors). All other data are provided as supplementary information only. For more details, please consult our CB, UL or CSA certificates and technical datasheet available on <http://www.TE.com>



## Accessories

Description	Color	Type	Part Number	Pkg qty	Weight (1 pce) g
<b>1 End stops</b>	Dark grey	BAZ1	1SNK900002R0000	50	5.30
<b>2 End sections</b>	Dark grey	EK2.5-4P	1SNK705912R0000	20	2.70
<b>3 Jumper bars</b>	Orange	JB5-2 JB5-3 JB5-4 JB5-5 JB5-10 JB5-50	1SNK905302R0000 1SNK905303R0000 1SNK905304R0000 1SNK905305R0000 1SNK905310R0000 1SNK905350R0000	50 50 50 50 30 10	1.30 2.00 2.70 3.50 7.10 36.00
<b>4 Cross spacing jumpers</b>	Orange	JB85-3	1SNK900603R0000	10	2.80
<b>5 Circuit separators</b>	Dark grey	CS-R3	1SNK900107R0000	20	6.40
<b>6 Test adapters</b>	Dark grey	TP2 TP4	1SNK900203R0000 1SNK900205R0000	20 20	1.70 2.40
<b>7 Test connectors</b>	Dark grey	TC5 TC5-R1	1SNK900200R0000 1SNK900201R0000	10 10	5.20 5.20
<b>8 Terminal block markers</b>	White	MG-CPM 13 41790 MC512 MC512PA	1SNB041790R0512 1SNK140000R0000 1SNK149999R0000	1960 22 20	0.23 9.00 10.00
	Grey	UMH	1SNK900611R0000	10	0.20

Complete list of accessories is indicated in the terminal block datasheet including end stops. Some accessories such as jumper bars may modify the terminal block's ratings: Complete information available in the accessories section of the catalog.

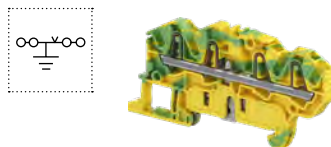

## Ground PI-Spring terminal blocks

Description	Color	Type	Part Number	Pkg qty	Weight (1 pce) g
Ground Profile aligned with ZK2.5-4P	Green-yellow	ZK2.5-PE-4P	1SNK705152R0000	20	13.60

Technical data valid for copper conductors only.

# ZK4 PI-Spring terminal blocks

## Feed-through - 6 mm 0.236 in spacing



ZK4

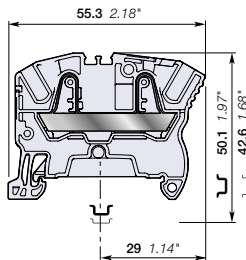

6 mm 0.236 in spacing

### Description

Combine high performance with compact dimensions:

- 1000 V AC / DC IEC 600 V UL,
- Opt for the best marking visibility thanks to the up-front, flat marker zone, which lets you mark up to eight digits or increase the font size.

### Ordering details

Description	Color	Type	Part Number	Pkg qty	Weight (1 pce) g
Feed-through 2 connections	Grey	ZK4	1SNK706010R0000	50	7.90
	Blue	ZK4-BL	1SNK706020R0000	50	7.90
	Orange	ZK4-OR	1SNK706030R0000	50	7.90
	Yellow	ZK4-YL	1SNK706060R0000	50	7.90
	Red	ZK4-RD	1SNK706062R0000	50	7.90
	Black	ZK4-BK	1SNK706066R0000	50	7.90

### Main technical data

Connecting capacity		IEC	UL - CSA	Mounting instructions	
1 conductor per clamp	Rigid: Solid/Stranded	0.5 ... 6 mm <sup>2</sup>	26 ... 10 AWG	Rail	TH 35-7.5, TH 35-15
	Flexible without ferrule	0.5 ... 4 mm <sup>2</sup>		Wire stripping length	12.5 mm 0.492 in
	Flexible with non insulated ferrule	0.5 ... 4 mm <sup>2</sup>	26 ... 12 AWG	Tool (for flexible conductor without ferrule)	Flat screwdriver Ø 3.5 mm Ø 0.138 in
	Flexible with insulated ferrule	0.5 ... 4 mm <sup>2</sup>	26 ... 12 AWG		
2 conductors per clamp	Flexible with twin ferrule	0.5 ... 1 mm <sup>2</sup>	26 ... 18 AWG		
<b>Rated current / Rated cross section</b>		32 A / 4 mm <sup>2</sup>	30 A / 10 AWG		
<b>Rated short-time withstand current (1s)</b>		480 A	636 A		
<b>Short Circuit Current Rating (with specific conditions)</b>			100 kA		
<b>Rated voltage</b>		1000 V	600 V		
<b>Impulse withstand voltage</b>		8000 V			
<b>Protection</b>		IP20	NEMA 1		
<b>Increased safety Ex e</b>		693 V 29 A IEC/EN 60079-7 - IM2 II 2 GD Ex eb I/IC/II/C			

The connecting capacity data for one Rigid: Solid/Stranded, or one Flexible conductor (when applicable) is a mandatory information required by IEC, UL and CSA standards (Copper conductors). All other data are provided as supplementary information only. For more details, please consult our CB, UL or CSA certificates and technical datasheet available on <http://www.TE.com>



### Accessories

Description	Color	Type	Part Number	Pkg qty	Weight (1 pce) g	
1 End stops	Dark grey	BAZ1	1SNK900002R0000	50	5.30	
2 End sections	Dark grey	EK2.5	1SNK705910R0000	20	1.80	
3 Jumper bars	Orange	2 poles	JB6-2	1SNK906302R0000	50	1.30
		3 poles	JB6-3	1SNK906303R0000	50	2.10
		4 poles	JB6-4	1SNK906304R0000	50	2.90
		5 poles	JB6-5	1SNK906305R0000	50	3.60
		10 poles	JB6-10	1SNK906310R0000	20	7.40
4 Cross spacing jumpers	Orange	3 poles	JB85-3	1SNK900603R0000	10	2.80
		5 poles	JB85-5	1SNK900605R0000	10	3.80
5 Circuit separators	Dark grey	CS-R2	1SNK900106R0000	20	3.80	
6 Test adapters	Dark grey	For test plugs DIA 2 mm 0.079 in	TP2	1SNK900203R0000	20	1.70
		For test plugs DIA 4 mm 0.157 in	TP4	1SNK900205R0000	20	2.40
7 Test connectors	Dark grey	TC5-R1	1SNK900201R0000	10	5.20	
8 Spacers	Dark grey	ES-TC6	1SNK900105R0000	10	0.80	
9 Terminal block markers	White	Blank marker	MG-CPM 13 41791	1SNB041791R0612	1680	0.27
		Blank card	MC612	1SNK150000R0000	22	10.00
		Universal wire markers holder	MC612PA	1SNK159999R0000	20	11.00
	Grey	UMH	1SNK900611R0000	10	0.20	

Complete list of accessories is indicated in the terminal block datasheet including end stops. Some accessories such as jumper bars may modify the terminal block's ratings: Complete information available in the accessories section of the catalog.



### Ground PI-Spring terminal blocks

Description	Color	Type	Part Number	Pkg qty	Weight (1 pce) g
Ground Profile aligned with ZK4	Green-yellow	ZK4-PE	1SNK706150R0000	20	12.60

Technical data valid for copper conductors only.

# ZK4-3P PI-Spring terminal blocks

Feed-through with 3 connections - 6 mm 0.236 in spacing

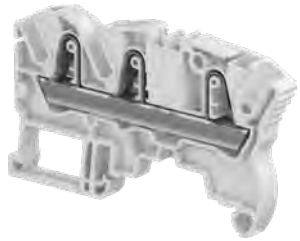

ZK4-3P

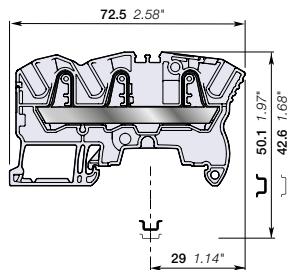

6 mm 0.236 in spacing

## Description

Find all the features of the ZK4 terminal block with the added option of distributing or branching 3 conductors.

## Ordering details

Description	Color	Type	Part Number	Pkg qty	Weight (1 pce) g
Feed-through 3 connections	Grey	ZK4-3P	1SNK706011R0000	50	11.00
	Blue	ZK4-3P-BL	1SNK706021R0000	50	11.00
	Orange	ZK4-3P-OR	1SNK706031R0000	50	11.00

## Main technical data

Connecting capacity		IEC	UL - CSA	Mounting instructions	
1 conductor per clamp	Rigid: Solid/Stranded	0.5 ... 6 mm²	26 ... 10 AWG	Rail	TH 35-7.5, TH 35-15
	Flexible without ferrule	0.5 ... 4 mm²		Wire stripping length	12.5 mm 0.492 in
	Flexible with non insulated ferrule	0.5 ... 4 mm²	26 ... 12 AWG		
	Flexible with insulated ferrule	0.5 ... 4 mm²	26 ... 12 AWG		
2 conductors per clamp	Flexible with twin ferrule	0.5 ... 1 mm²	26 ... 18 AWG	Tool (for flexible conductor without ferrule)	Flat screwdriver Ø 3.5 mm Ø 0.138 in
Rated current / Rated cross section		32 A / 4 mm²	30 A / 10 AWG		
Rated short-time withstand current (1s)		480 A	636 A		
Short Circuit Current Rating (with specific conditions)			100 kA		
Rated voltage		1000 V	600 V		
Impulse withstand voltage		8000 V			
Protection		IP20	NEMA 1		
Increased safety Ex e		693 V 29 A IEC/EN 60079-7 - IM2 II 2 GD Ex eb I/IIc/IIIC			

The connecting capacity data for one Rigid: Solid/Stranded, or one Flexible conductor (when applicable) is a mandatory information required by IEC, UL and CSA standards (Copper conductors). All other data are provided as supplementary information only. For more details, please consult our CB, UL or CSA certificates and technical datasheet available on <http://www.TE.com>

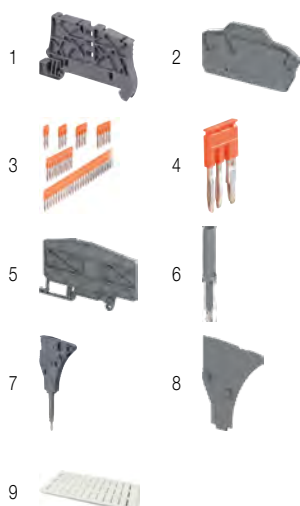

## Accessories

Description	Color	Type	Part Number	Pkg qty	Weight (1 pce) g	
1 End stops	Dark grey	BAZ1	1SNK900002R0000	50	5.30	
2 End sections	Dark grey	EK2.5-3P	1SNK705911R0000	20	2.40	
3 Jumper bars	Orange	2 poles	JB6-2	1SNK906302R0000	50	1.30
		3 poles	JB6-3	1SNK906303R0000	50	2.10
		4 poles	JB6-4	1SNK906304R0000	50	2.90
		5 poles	JB6-5	1SNK906305R0000	50	3.60
		10 poles	JB6-10	1SNK906310R0000	20	7.40
		50 poles	JB6-50	1SNK906350R0000	10	38.10
4 Cross spacing jumpers	Orange	JB85-3	1SNK900603R0000	10	2.80	
5 Circuit separators	Dark grey	3 mm	CS-R3	1SNK900107R0000	20	6.40
		0.118 in				
6 Test adapters	Dark grey	For test plugs DIA 2 mm 0.079 in	TP2	1SNK900203R0000	20	1.70
		For test plugs DIA 4 mm 0.157 in	TP4	1SNK900205R0000	20	2.40
7 Test connectors	Dark grey	TC5-R1	1SNK900201R0000	10	5.20	
8 Spacers	Dark grey	ES-TC6	1SNK900105R0000	10	0.80	
9 Terminal block markers	White	Blank marker	MG-CPM 13 41791	1SNB041791R0612	1680	0.27
		Blank card	MC612	1SNK150000R0000	22	10.00
			MC612PA	1SNK159999R0000	20	11.00
	Universal wire markers holder	Grey	UMH	1SNK900611R0000	10	0.20

Complete list of accessories is indicated in the terminal block datasheet including end stops. Some accessories such as jumper bars may modify the terminal block's ratings: Complete information available in the accessories section of the catalog.



## Ground PI-Spring terminal blocks

Description	Color	Type	Part Number	Pkg qty	Weight (1 pce) g
Ground	Green-yellow	ZK4-PE-3P	1SNK706151R0000	20	15.70

Technical data valid for copper conductors only.



# ZK4-4P PI-Spring terminal blocks

Feed-through with 4 connections - 6 mm 0.236 in spacing



ZK4-4P

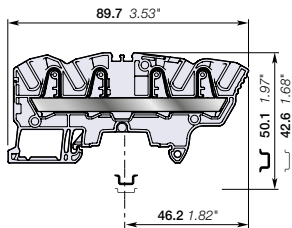

6 mm 0.236 in spacing

## Description

Find all the features of the ZK4 terminal block with the added option of distributing or branching 4 conductors.

## Ordering details

Description	Color	Type	Part Number	Pkg qty	Weight (1 pce) g
Feed-through 4 connections	Grey	ZK4-4P	1SNK706012R0000	50	13.80
	Blue	ZK4-4P-BL	1SNK706022R0000	50	13.80
	Orange	ZK4-4P-OR	1SNK706032R0000	50	13.80

## Main technical data

Connecting capacity		IEC	UL - CSA	Mounting instructions	
1 conductor per clamp	Rigid: Solid/Stranded	0.5 ... 6 mm <sup>2</sup>	26 ... 10 AWG	Rail	TH 35-7.5, TH 35-15
	Flexible without ferrule	0.5 ... 4 mm <sup>2</sup>		Wire stripping length	12.5 mm 0.492 in
	Flexible with non insulated ferrule	0.5 ... 4 mm <sup>2</sup>	26 ... 12 AWG		
	Flexible with insulated ferrule	0.5 ... 4 mm <sup>2</sup>	26 ... 12 AWG		
2 conductors per clamp	Flexible with twin ferrule	0.5 ... 1 mm <sup>2</sup>	26 ... 18 AWG	Tool (for flexible conductor without ferrule)	Flat screwdriver Ø 3.5 mm Ø 0.138 in
Rated current / Rated cross section		32 A / 4 mm <sup>2</sup>	30 A / 10 AWG		
Rated short-time withstand current (1s)		480 A	636 A		
Short Circuit Current Rating (with specific conditions)			100 kA		
Rated voltage		1000 V	600 V		
Impulse withstand voltage		8000 V			
Protection		IP20	NEMA 1		
Increased safety Ex e		693 V 29 A IEC/EN 60079-7 - IM2 II 2 GD Ex eb I/IC/IIIC			

The connecting capacity data for one Rigid: Solid/Stranded, or one Flexible conductor (when applicable) is a mandatory information required by IEC, UL and CSA standards (Copper conductors). All other data are provided as supplementary information only. For more details, please consult our CB, UL or CSA certificates and technical datasheet available on <http://www.TE.com>

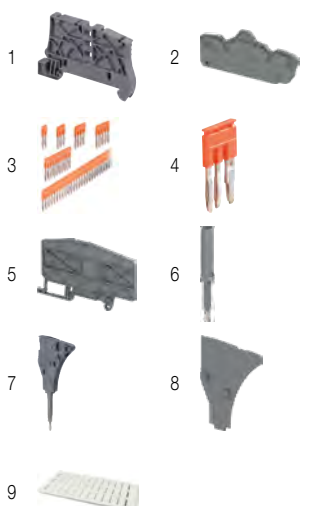
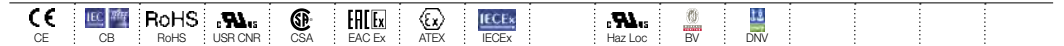

## Accessories

Description	Color	Type	Part Number	Pkg qty	Weight (1 pce) g	
1 End stops	Dark grey	BAZ1	1SNK900002R0000	50	5.30	
2 End sections	Dark grey	EK2.5-4P	1SNK705912R0000	20	2.70	
3 Jumper bars	Orange	2 poles	JB6-2	1SNK906302R0000	50	1.30
		3 poles	JB6-3	1SNK906303R0000	50	2.10
		4 poles	JB6-4	1SNK906304R0000	50	2.90
		5 poles	JB6-5	1SNK906305R0000	50	3.60
		10 poles	JB6-10	1SNK906310R0000	20	7.40
		50 poles	JB6-50	1SNK906350R0000	10	38.10
4 Cross spacing jumpers	Orange	JB85-3	1SNK900603R0000	10	2.80	
5 Circuit separators	Dark grey	CS-R3	1SNK900107R0000	20	6.40	
6 Test adapters	Dark grey	For test plugs DIA 2 mm 0.079 in	TP2	1SNK900203R0000	20	1.70
		For test plugs DIA 4 mm 0.157 in	TP4	1SNK900205R0000	20	2.40
7 Test connectors	Dark grey	TC5-R1	1SNK900201R0000	10	5.20	
8 Spacers	Dark grey	ES-TC6	1SNK900105R0000	10	0.80	
9 Terminal block markers	White	Blank marker	MG-CPM 13 41791	1SNB041791R0612	1680	0.27
		Blank card	MC612	1SNK150000R0000	22	10.00
		Universal wire markers holder	MC612PA	1SNK159999R0000	20	11.00
	Grey	UMH	1SNK900611R0000	10	0.20	

Complete list of accessories is indicated in the terminal block datasheet including end stops. Some accessories such as jumper bars may modify the terminal block's ratings: Complete information available in the accessories section of the catalog.



## Ground PI-Spring terminal blocks

Description	Color	Type	Part Number	Pkg qty	Weight (1 pce) g
Ground	Green-yellow	ZK4-PE-4P	1SNK706152R0000	20	18.40

Technical data valid for copper conductors only.



# ZK6 PI-Spring terminal blocks

## Feed-through - 8 mm 0.315 in spacing



ZK6

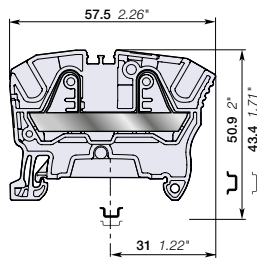

8 mm 0.315 in spacing

### Description

Combine high performance with compact dimensions:

- 1000 V AC / DC IEC 600 V UL,
- Opt for the best marking visibility thanks to the up-front, flat marker zone, which lets you mark up to eight digits or increase the font size.

### Ordering details

Description	Color	Type	Part Number	Pkg qty	Weight (1 pce) g
Feed-through 2 connections	Grey	ZK6	1SNK708010R0000	50	11.80
	Blue	ZK6-BL	1SNK708020R0000	50	11.80
	Orange	ZK6-OR	1SNK708030R0000	50	11.80
	Yellow	ZK6-YL	1SNK708060R0000	50	11.80
	Red	ZK6-RD	1SNK708062R0000	50	11.80
	Black	ZK6-BK	1SNK708066R0000	50	11.80

### Main technical data

Connecting capacity		IEC	UL - CSA	Mounting instructions	
1 conductor per clamp	Rigid: Solid/Stranded	0.5 ... 10 mm²	24 ... 8 AWG	Rail	TH 35-7.5, TH 35-15
	Flexible without ferrule	0.5 ... 6 mm²		Wire stripping length	12.5 mm 0.492 in
	Flexible with non insulated ferrule	0.5 ... 6 mm²	24 ... 10 AWG		
	Flexible with insulated ferrule	0.5 ... 6 mm²	24 ... 10 AWG		
2 conductors per clamp	Flexible with twin ferrule	0.5 ... 1.5 mm²	24 ... 16 AWG	Tool (for flexible conductor without ferrule)	Flat screwdriver Ø 3.5 mm Ø 0.138 in
Rated current / Rated cross section		41 A / 6 mm²	50 A / 8 AWG		
Rated short-time withstand current (1s)		720 A	1008 A		
Short Circuit Current Rating (with specific conditions)			100 kA		
Rated voltage		1000 V	600 V		
Impulse withstand voltage		8000 V			
Protection		IP20	NEMA 1		
Increased safety Ex e		693 V 37 A IEC/EN 60079-7 - IM2 II 2 GD Ex eb I/II/III/C			

The connecting capacity data for one Rigid: Solid/Stranded, or one Flexible conductor (when applicable) is a mandatory information required by IEC, UL and CSA standards (Copper conductors). All other data are provided as supplementary information only. For more details, please consult our CB, UL or CSA certificates and technical datasheet available on <http://www.TE.com>



### Accessories

Description	Color	Type	Part Number	Pkg qty	Weight (1 pce) g	
1 End stops	Dark grey	BAZ1	1SNK900002R0000	50	5.30	
2 End sections	Dark grey	EK2.5	1SNK705910R0000	20	1.80	
3 Jumper bars	Orange	2 poles	JB8-2	1SNK908302R0000	50	2.70
		3 poles	JB8-3	1SNK908303R0000	50	4.10
		4 poles	JB8-4	1SNK908304R0000	50	5.60
		5 poles	JB8-5	1SNK908305R0000	40	7.00
		10 poles	JB8-10	1SNK908310R0000	20	14.20
4 Cross spacing jumpers	Orange	JB85-3	1SNK900603R0000	10	2.80	
5 Circuit separators	Dark grey	CS-R2	1SNK900106R0000	20	3.80	
6 Test adapters	Dark grey	For test plugs DIA 2 mm 0.079 in	TP2	1SNK900203R0000	20	1.70
		For test plugs DIA 4 mm 0.157 in	TP4	1SNK900205R0000	20	2.40
7 Test connectors	Dark grey	TC5-R1	1SNK900201R0000	10	5.20	
8 Spacers	Dark grey	2.8 mm	ES-TC8	1SNK900104R0000	10	1.40
		Blank marker	MG-CPM 13 41791	1SNB041791R0612	1680	0.27
		Blank card	MC812	1SNK160000R0000	22	10.00
			MC812PA	1SNK169999R0000	20	14.00
9 Terminal block markers	Grey	UMH	1SNK900611R0000	10	0.20	

Complete list of accessories is indicated in the terminal block datasheet including end stops.

Some accessories such as jumper bars may modify the terminal block's ratings: Complete information available in the accessories section of the catalog.



### Ground PI-Spring terminal blocks

Description	Color	Type	Part Number	Pkg qty	Weight (1 pce) g
Ground	Green-yellow	ZK6-PE	1SNK708150R0000	20	20.30

Technical data valid for copper conductors only.



# ZK6-3P PI-Spring terminal blocks

Feed-through with 3 connections - 8 mm 0.315 in spacing

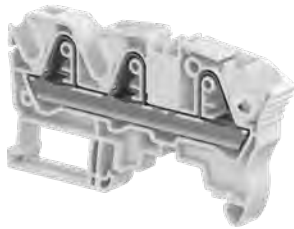

1SNK162019R0014

ZK6-3P

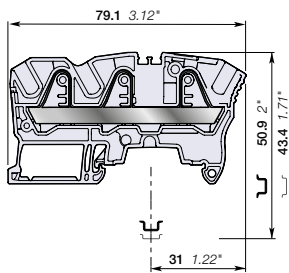

8 mm 0.315 in spacing

## Description

Find all the features of the ZK6 terminal block with the added option of distributing or branching 3 conductors.

## Ordering details

Description	Color	Type	Part Number	Pkg qty	Weight (1 pce) g
Feed-through 3 connections	Grey	ZK6-3P	1SNK708011R0000	50	16.70
	Blue	ZK6-3P-BL	1SNK708021R0000	50	16.70
	Orange	ZK6-3P-OR	1SNK708031R0000	50	16.70

## Main technical data

Connecting capacity		IEC	UL - CSA	Mounting instructions	
1 conductor per clamp	Rigid: Solid/Stranded	0.5 ... 10 mm <sup>2</sup>	24 ... 8 AWG	Rail	TH 35-7.5, TH 35-15
	Flexible without ferrule	0.5 ... 6 mm <sup>2</sup>		Wire stripping length	12.5 mm 0.492 in
	Flexible with non insulated ferrule	0.5 ... 6 mm <sup>2</sup>	24 ... 10 AWG		
	Flexible with insulated ferrule	0.5 ... 6 mm <sup>2</sup>	24 ... 10 AWG		
2 conductors per clamp	Flexible with twin ferrule	0.5 ... 1.5 mm <sup>2</sup>	24 ... 16 AWG	Tool (for flexible conductor without ferrule)	Flat screwdriver Ø 3.5 mm Ø 0.138 in
Rated current / Rated cross section		41 A / 6 mm <sup>2</sup>	50 A / 8 AWG		
Rated short-time withstand current (1s)		720 A	1008 A		
Short Circuit Current Rating (with specific conditions)			100 kA		
Rated voltage		1000 V	600 V		
Impulse withstand voltage		8000 V			
Protection		IP20	NEMA 1		
Increased safety Ex e		693 V 37 A IEC/EN 60079-7 - IM2 II 2 GD Ex eb I/IC/IIIC			

The connecting capacity data for one Rigid: Solid/Stranded, or one Flexible conductor (when applicable) is a mandatory information required by IEC, UL and CSA standards (Copper conductors). All other data are provided as supplementary information only. For more details, please consult our CB, UL or CSA certificates and technical datasheet available on <http://www.TE.com>

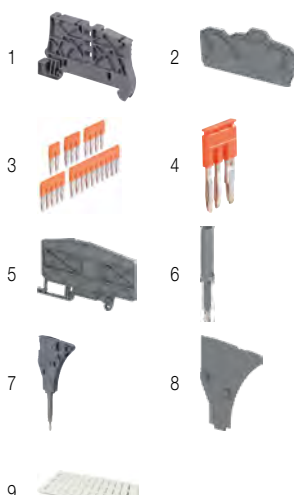

## Accessories

Description	Color	Type	Part Number	Pkg qty	Weight (1 pce) g	
1 End stops	Dark grey	BAZ1	1SNK900002R0000	50	5.30	
2 End sections	Dark grey	EK6-3P	1SNK708911R0000	20	2.80	
3 Jumper bars	Orange	2 poles	JB8-2	1SNK908302R0000	50	2.70
		3 poles	JB8-3	1SNK908303R0000	50	4.10
		4 poles	JB8-4	1SNK908304R0000	50	5.60
		5 poles	JB8-5	1SNK908305R0000	40	7.00
		10 poles	JB8-10	1SNK908310R0000	20	14.20
4 Cross spacing jumpers	Orange	JB85-3	1SNK900603R0000	10	2.80	
5 Circuit separators	Dark grey	CS-R3	1SNK900107R0000	20	6.40	
6 Test adapters	Dark grey	For test plugs DIA 2 mm 0.079 in	TP2	1SNK900203R0000	20	1.70
		For test plugs DIA 4 mm 0.157 in	TP4	1SNK900205R0000	20	2.40
7 Test connectors	Dark grey	TC5-R1	1SNK900201R0000	10	5.20	
8 Spacers	Dark grey	ES-TC8	1SNK900104R0000	10	1.40	
			1SNK900104R0000	10	1.40	
			1SNK900104R0000	10	1.40	
9 Terminal block markers	White	MG-CPM 13 41791	1SNKB041791R0612	1680	0.27	
			MC812	1SNK160000R0000	22	10.00
			MC812PA	1SNK169999R0000	20	14.00
			Universal wire markers holder	Grey	UMH	1SNK900611R0000

Complete list of accessories is indicated in the terminal block datasheet including end stops. Some accessories such as jumper bars may modify the terminal block's ratings. Complete information available in the accessories section of the catalog.

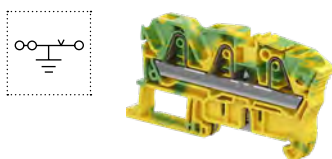

## Ground PI-Spring terminal blocks

Description	Color	Type	Part Number	Pkg qty	Weight (1 pce) g
Ground	Green-yellow	ZK6-PE-3P	1SNK708151R0000	20	21.50

Technical data valid for copper conductors only.

# ZK10 PI-Spring terminal blocks

## Feed-through - 10 mm 0.394 in spacing



ZK10

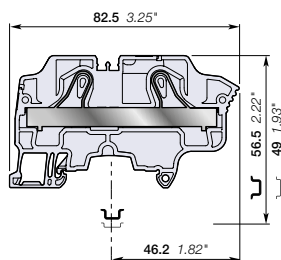

10 mm 0.394 in spacing

### Description

Combine high performance with compact dimensions:

- 1000 V AC / DC IEC 600 V UL,
- Opt for the best marking visibility thanks to the up-front, flat marker zone, which lets you mark up to eight digits or increase the font size.

### Ordering details

Description	Color	Type	Part Number	Pkg qty	Weight (1 pce) g
Feed-through 2 connections	Grey <input type="checkbox"/>	ZK10	1SNK710010R0000	20	27.20
	Blue <input type="checkbox"/>	ZK10-BL	1SNK710020R0000	20	27.20
	Orange <input type="checkbox"/>	ZK10-OR	1SNK710030R0000	20	27.20

### Main technical data

Connecting capacity	IEC	UL - CSA	Mounting instructions
1 conductor per clamp	Rigid: Solid/Stranded	0.5 ... 16 mm <sup>2</sup>	20 ... 6 AWG
	Flexible without ferrule	0.5 ... 10 mm <sup>2</sup>	20 ... 8 AWG
	Flexible with non insulated ferrule	0.5 ... 10 mm <sup>2</sup>	20 ... 8 AWG
	Flexible with insulated ferrule	0.5 ... 10 mm <sup>2</sup>	20 ... 8 AWG
2 conductors per clamp	Flexible with twin ferrule	0.5 ... 4 mm <sup>2</sup>	20 ... 12 AWG
<b>Rated current / Rated cross section</b>		57 A / 10 mm <sup>2</sup>	55 A / 6 AWG
<b>Rated short-time withstand current (1s)</b>		1200 A	1596 A
<b>Short Circuit Current Rating (with specific conditions)</b>			100 kA
<b>Rated voltage</b>		1000 V	600 V
<b>Impulse withstand voltage</b>		8000 V	
<b>Protection</b>		IP20	NEMA 1
<b>Increased safety Ex e</b>		693 V 51 A IEC/EN 60079-7 - IM2 II 2 GD Ex eb I/II/C/IIIC	

The connecting capacity data for one Rigid: Solid/Stranded, or one Flexible conductor (when applicable) is a mandatory information required by IEC, UL and CSA standards (Copper conductors). All other data are provided as supplementary information only. For more details, please consult our CB, UL or CSA certificates and technical datasheet available on <http://www.TE.com>



### Accessories

Description	Color	Type	Part Number	Pkg qty	Weight (1 pce) g	
1 End stops	Dark grey <input type="checkbox"/>	BAZ1	1SNK900002R0000	50	5.30	
2 End sections	Dark grey <input type="checkbox"/>	EK10	1SNK710910R0000	20	3.30	
3 Jumper bars	Orange <input type="checkbox"/>	2 poles	JB10-2	1SNK910302R0000	50	4.60
		3 poles	JB10-3	1SNK910303R0000	50	7.10
		4 poles	JB10-4	1SNK910304R0000	40	9.40
		5 poles	JB10-5	1SNK910305R0000	30	12.00
		10 poles	JB10-10	1SNK910310R0000	20	24.00
4 Circuit separators	Dark grey <input type="checkbox"/>	CS-R3	1SNK900107R0000	20	6.40	
5 Test adapters	Dark grey <input type="checkbox"/>	For test plugs DIA 2 mm 0.079 in	TP2	1SNK900203R0000	20	1.70
		For test plugs DIA 4 mm 0.157 in	TP4	1SNK900205R0000	20	2.40
6 Terminal block markers	White <input type="checkbox"/>	Blank marker	MG-CPM 13 41791	1SNB041791R0612	1680	0.27
		Blank card	MC812	1SNK160000R0000	22	10.00
			MC812PA	1SNK169999R0000	20	14.00
	Universal wire markers holder	Grey <input type="checkbox"/>	UMH	1SNK900611R0000	10	0.20

Complete list of accessories is indicated in the terminal block datasheet including end stops.

Some accessories such as jumper bars may modify the terminal block's ratings: Complete information available in the accessories section of the catalog.

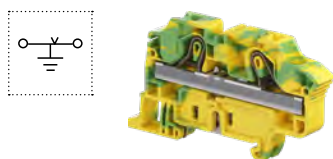

### Ground PI-Spring terminal blocks

Description	Color	Type	Part Number	Pkg qty	Weight (1 pce) g
Ground	Green-yellow <input type="checkbox"/>	ZK10-PE	1SNK710150R0000	20	36.20

Technical data valid for copper conductors only.



# ZK10-PV PI-Spring terminal blocks

## Feed-through - 12 mm 0.472 in spacing

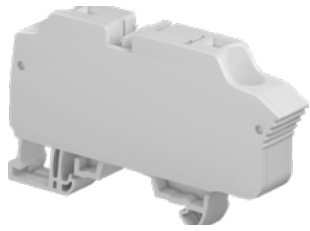

1SNK10212A00014

### Description

- Specially designed for high voltage utility scale solar power plants:
- Rated voltage of 1500 V DC IEC and 1000 V DC UL,
  - Pre-mounted end section with light grey color specific to this application,
  - Improved design with ribs to increase creepage distance,
  - Compact solution only 2 mm thicker than normal product,
  - Compatible with JB12 jumpers to interconnect multiple terminal blocks.

### Ordering details

Description	Color	Type	Part Number	Pkg qty	Weight (1 pce) g
Feed-through 2 connections	Grey	ZK10-PV	1SNK710063R0000	20	29.86
	Blue	ZK10-PV-BL	1SNK710065R0000	20	29.86

### Main technical data

Connecting capacity	IEC	UL - CSA	Mounting instructions
1 conductor per clamp	Rigid: Solid/Stranded	20 ... 6 AWG	Rail
	Flexible without ferrule	20 ... 6 AWG	Wire stripping length
	Flexible with non insulated ferrule	20 ... 8 AWG	TH 35-7.5, TH 35-15
	Flexible with insulated ferrule	20 ... 8 AWG	15 mm 0.591 in
2 conductors per clamp	Flexible with twin ferrule	20 ... 12 AWG	Tool (for flexible conductor without ferrule)
			Flat screwdriver Ø 4 mm Ø 0.157 in
Rated current / Rated cross section		57 A / 10 mm²	
Rated short-time withstand current (1s)		1200 A	
Short Circuit Current Rating (with specific conditions)		55 A / 6 AWG	
Rated voltage		1000 V AC / 1500 V DC	
Impulse withstand voltage		1596 A	
Protection		100 kA	
		8000 V	
		IP20	
		NEMA 1	

ZK10-PV

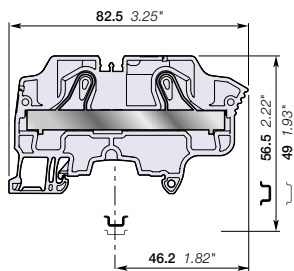

12 mm 0.472 in spacing

The connecting capacity data for one Rigid: Solid/Stranded, or one Flexible conductor (when applicable) is a mandatory information required by IEC, UL and CSA standards (Copper conductors). All other data are provided as supplementary information only. For more details, please consult our CB, UL or CSA certificates and technical datasheet available on <http://www.TE.com>

CE	IEC CB	RoHS	UL	CSA	EAC														
----	--------	------	----	-----	-----	--	--	--	--	--	--	--	--	--	--	--	--	--	--

### Accessories

Description	Color	Type	Part Number	Pkg qty	Weight (1 pce) g	
1 End stops	Dark grey	BAZ1	1SNK900002R0000	50	5.30	
2 Jumper bars	Orange	2 poles	JB12-2	1SNK912302R0000	50	4.90
		3 poles	JB12-3	1SNK912303R0000	50	7.60
		5 poles	JB12-5	1SNK912305R0000	20	12.90
3 Circuit separators	Dark grey	3 mm	CS-R3	1SNK900107R0000	20	6.40
4 Test adapters	Dark grey	For test plugs DIA 2 mm 0.079 in	TP2	1SNK900203R0000	20	1.70
		For test plugs DIA 4 mm 0.157 in	TP4	1SNK900205R0000	20	2.40
5 Terminal block markers	White	Blank card	MC812	1SNK160000R0000	22	10.00
			MC812PA	1SNK169999R0000	20	14.00
	Blank marker	MG-CPM 13 41791	1SNK041791R0612	1680	0.273	
	Universal wire markers holder	Grey	UMH	1SNK900611R0000	10	0.20

Complete list of accessories is indicated in the terminal block datasheet including end stops. Some accessories such as jumper bars may modify the terminal block's ratings: Complete information available in the accessories section of the catalog.

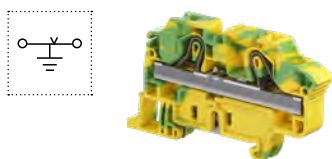

### Ground PI-Spring terminal blocks

Description	Color	Type	Part Number	Pkg qty	Weight (1 pce) g
Ground	Green-yellow	ZK10-PE	1SNK710150R0000	20	36.20

Technical data valid for copper conductors only.

# ZK10-3P PI-Spring terminal blocks

Feed-through with 3 connections - 10 mm 0.394 in spacing



ZK10-3P

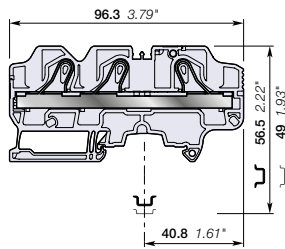

10 mm 0.394 in spacing

## Description

- Find all the features of the ZK10 terminal block with the added option of distributing or branching 3 conductors,
- ZK10-3P is perfectly adapted to solar applications: 1250 V DC (1000 V AC) IEC, 1000 V UL.

## Ordering details

Description	Color	Type	Part Number	Pkg qty	Weight (1 pce) g
Feed-through 3 connections	Grey <input type="checkbox"/>	ZK10-3P	1SNK710011R0000	20	34.9
	Blue <input type="checkbox"/>	ZK10-3P-BL	1SNK710021R0000	20	34.9

## Main technical data

Connecting capacity	IEC	UL - CSA	Rail	Mounting instructions
<b>1 conductor per clamp</b>	Rigid: Solid/Stranded	0.5 ... 16 mm <sup>2</sup>	20 ... 6 AWG	 Wire stripping length 15 mm 0.591 in
	Flexible without ferrule	0.5 ... 10 mm <sup>2</sup>		
	Flexible with non insulated ferrule	0.5 ... 10 mm <sup>2</sup>	20 ... 8 AWG	
	Flexible with insulated ferrule	0.5 ... 10 mm <sup>2</sup>	20 ... 8 AWG	
<b>2 conductors per clamp</b>	Flexible with twin ferrule	0.5 ... 4 mm <sup>2</sup>	20 ... 12 AWG	 Tool (for flexible conductor without ferrule) Flat screwdriver Ø 4 mm Ø 0.157 in
<b>Rated current / Rated cross section</b>		57 A / 10 mm <sup>2</sup>	56 A / 6 AWG	
<b>Rated short-time withstand current (1s)</b>		1200 A		
<b>Short Circuit Current Rating (with specific conditions)</b>			100 kA	
<b>Rated voltage</b>		1000 V	1000 V	
<b>Impulse withstand voltage</b>		8000 V		
<b>Protection</b>		IP20	NEMA 1	
<b>Increased safety Ex e</b>		693 V 57 A - IM2 II 2 GD Ex eb I/IIIC		

The connecting capacity data for one Rigid: Solid/Stranded, or one Flexible conductor (when applicable) is a mandatory information required by IEC, UL and CSA standards (Copper conductors). All other data are provided as supplementary information only. For more details, please consult our CB, UL or CSA certificates and technical datasheet available on <http://www.TE.com>



## Accessories

Description	Color	Type	Part Number	Pkg qty	Weight (1 pce) g	
<b>1 End stops</b>	Dark grey <input type="checkbox"/>	BAZ1	1SNK900002R0000	50	5.30	
<b>2 End sections</b>	Dark grey <input type="checkbox"/>	EK10-3P	1SNK710911R0000	20	4.5	
<b>3 Jumper bars</b>	Orange <input type="checkbox"/>	2 poles 76 A (IEC)	JB10-2	1SNK910302R0000	50	4.60
		3 poles 76 A (IEC)	JB10-3	1SNK910303R0000	50	7.10
		4 poles 76 A (IEC)	JB10-4	1SNK910304R0000	40	9.40
		5 poles 76 A (IEC)	JB10-5	1SNK910305R0000	30	12.00
		10 poles 76 A (IEC)	JB10-10	1SNK910310R0000	20	24.00
<b>4 Test adapters</b>	Dark grey <input type="checkbox"/>	For test plugs DIA 2 mm 0.079 in	TP2	1SNK900203R0000	20	1.70
		For test plugs DIA 4 mm 0.157 in	TP4	1SNK900205R0000	20	2.40
<b>5 Terminal block markers</b>	White <input type="checkbox"/>	Blank marker	MG-CPM 13 41791	1SNB041791R0612	1680	0.27
		Blank card	MC812	1SNK160000R0000	22	10.00
			MC812PA	1SNK169999R0000	20	14.00
		Universal wire markers holder	Grey <input type="checkbox"/>	UMH	1SNK900611R0000	10

Complete list of accessories is indicated in the terminal block datasheet including end stops. Some accessories such as jumper bars may modify the terminal block's ratings: Complete information available in the accessories section of the catalog.

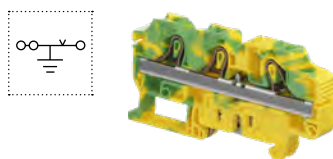

## Ground PI-Spring terminal blocks

Description	Color	Type	Part Number	Pkg qty	Weight (1 pce) g
<b>Ground</b>	Green-yellow <input type="checkbox"/>	ZK10-PE-3P	1SNK710151R0000	20	43.3

Technical data valid for copper conductors only.

# ZK10-3P-PV PI-Spring terminal blocks

Feed-through with 3 connections - 12 mm 0.472 in spacing

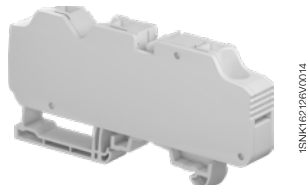

1SNK162128V0014

ZK10-3P-PV

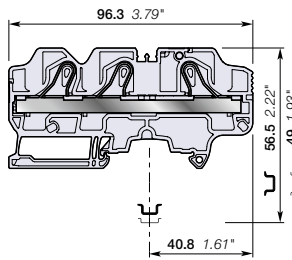

12 mm 0.472 in spacing

## Description

Specially designed for high voltage utility scale solar power plants:

- Rated voltage of 1500 V DC IEC and 1000 V DC UL,
- Pre-mounted end section with light grey color specific to this application,
- Improved design with ribs to increase creepage distance,
- Compact solution only 2 mm thicker than normal product,
- 3 connections configuration for easy grouping: 2 inputs / 1 output or 1 input / 2 outputs,
- Compatible with JB12 jumpers to interconnect multiple terminal blocks.

Description	Color	Type	Part Number	Pkg qty	Weight (1 pce) g
Feed-through 3 connections	Grey <input type="checkbox"/>	ZK10-3P-PV	1SNK710064R0000	20	38.61
	Blue <input type="checkbox"/>	ZK10-3P-PV-BL	1SNK710067R0000	20	38.61

## Main technical data

Connecting capacity		IEC	UL - CSA	Rail	Mounting instructions
1 conductor per clamp	Rigid: Solid/Stranded	0.5 ... 16 mm <sup>2</sup>	20 ... 6 AWG	Wire stripping length	
	Flexible without ferrule	0.5 ... 10 mm <sup>2</sup>			
	Flexible with non insulated ferrule	0.5 ... 10 mm <sup>2</sup>	20 ... 8 AWG		
	Flexible with insulated ferrule	0.5 ... 10 mm <sup>2</sup>	20 ... 8 AWG		
2 conductors per clamp	Flexible with twin ferrule	0.5 ... 4 AWG	20 ... 12 AWG	Tool (for flexible conductor without ferrule)	
Rated current / Rated cross section		57 A / 10 mm <sup>2</sup>	56 A / 6 AWG		
Rated short-time withstand current (1s)		1200 A	1596 A		
Short Circuit Current Rating (with specific conditions)			100 kA		
Rated voltage		1000 V AC / 1500 V DC	1000 V		
Impulse withstand voltage		8000 V			
Protection		IP20	NEMA 1		

The connecting capacity data for one Rigid: Solid/Stranded, or one Flexible conductor (when applicable) is a mandatory information required by IEC, UL and CSA standards (Copper conductors). All other data are provided as supplementary information only. For more details, please consult our CB, UL or CSA certificates and technical datasheet available on <http://www.TE.com>

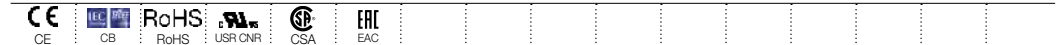

## Accessories

Description	Color	Type	Part Number	Pkg qty	Weight (1 pce) g	
1 End stops	Dark grey <input type="checkbox"/>	BAZ1	1SNK900002R0000	50	5.30	
2 Jumper bars	Orange <input type="checkbox"/>	2 poles	JB12-2	1SNK912302R0000	50	4.90
		3 poles	JB12-3	1SNK912303R0000	50	7.60
		5 poles	JB12-5	1SNK912305R0000	20	12.90
3 Circuit separators	Dark grey <input type="checkbox"/>	CS-R3	1SNK900107R0000	20	6.40	
4 Test adapters	Dark grey <input type="checkbox"/>	For test plugs DIA 2 mm 0.079 in	TP2	1SNK900203R0000	20	1.70
		For test plugs DIA 4 mm 0.157 in	TP4	1SNK900205R0000	20	2.40
5 Terminal block markers	White <input type="checkbox"/>	Blank card	MC812	1SNK160000R0000	22	10.00
			MC812PA	1SNK169999R0000	20	14.00
	Blank marker		MG-CPM 13 41791	1SNB041791R0612	1680	0.273
	Grey <input type="checkbox"/>	UMH	1SNK900611R0000	10	0.20	

Complete list of accessories is indicated in the terminal block datasheet including end stops. Some accessories such as jumper bars may modify the terminal block's ratings: Complete information available in the accessories section of the catalog.



## Ground PI-Spring terminal blocks

Description	Color	Type	Part Number	Pkg qty	Weight (1 pce) g
Ground	Green-yellow <input type="checkbox"/>	ZK10-PE-3P	1SNK710151R0000	20	43.3

Technical data valid for copper conductors only.

# ZK16 PI-Spring terminal blocks

## Feed-through - 12 mm 0.472 in spacing



ZK16

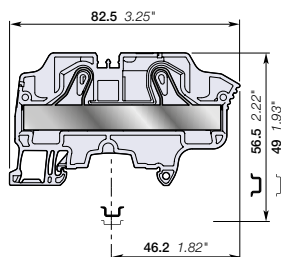

12 mm 0.472 in spacing

### Description

Combine high performance with compact dimensions:

- 1000 V AC / DC IEC 600 V UL,
- Opt for the best marking visibility thanks to the up-front, flat marker zone, which lets you mark up to eight digits or increase the font size.

### Ordering details

Description	Color	Type	Part Number	Pkg qty	Weight (1 pce) g
Feed-through 2 connections	Grey <input type="checkbox"/>	ZK16	1SNK712010R0000	20	33.80
	Blue <input type="checkbox"/>	ZK16-BL	1SNK712020R0000	20	33.80

### Main technical data

Connecting capacity	IEC	UL - CSA	Mounting instructions		
1 conductor per clamp	Rigid: Solid/Stranded	0.5 ... 25 mm <sup>2</sup>	20 ... 4 AWG	Rail	 TH 35-7.5, TH 35-15
	Flexible without ferrule	0.5 ... 16 mm <sup>2</sup>	20 ... 6 AWG		
	Flexible with non insulated ferrule	0.5 ... 16 mm <sup>2</sup>	20 ... 6 AWG	Wire stripping length	 15 mm 0.591 in
	Flexible with insulated ferrule	0.5 ... 16 mm <sup>2</sup>	20 ... 6 AWG		
2 conductors per clamp	Flexible with twin ferrule	0.5 ... 6 mm <sup>2</sup>	20 ... 10 AWG	Tool (for flexible conductor without ferrule)	 Flat screwdriver Ø 4 mm Ø 0.157 in
Rated current / Rated cross section		76 A / 16 mm <sup>2</sup>	75 A / 4 AWG		
Rated short-time withstand current (1s)		1920 A	2544 A		
Short Circuit Current Rating (with specific conditions)			100 kA		
Rated voltage		1000 V	600 V		
Impulse withstand voltage		8000 V			
Protection		IP20	NEMA 1		
Increased safety Ex e		693 V 69 A IEC/EN 60079-7 - IM2 II 2 GD Ex eb I/II/III/C			

The connecting capacity data for one Rigid: Solid/Stranded, or one Flexible conductor (when applicable) is a mandatory information required by IEC, UL and CSA standards (Copper conductors). All other data are provided as supplementary information only. For more details, please consult our CB, UL or CSA certificates and technical datasheet available on <http://www.TE.com>

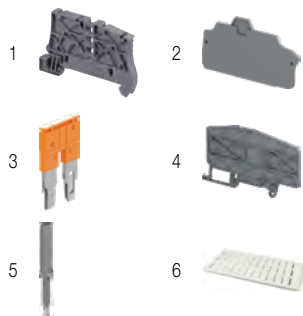

### Accessories

Description	Color	Type	Part Number	Pkg qty	Weight (1 pce) g	
1 End stops	Dark grey <input type="checkbox"/>	BAZ1	1SNK900002R0000	50	5.30	
2 End sections	Dark grey <input type="checkbox"/>	EK10	1SNK710910R0000	20	3.30	
3 Jumper bars	Orange <input type="checkbox"/>	2 poles	JB12-2	1SNK912302R0000	50	4.90
		3 poles	JB12-3	1SNK912303R0000	50	7.60
		5 poles	JB12-5	1SNK912305R0000	20	12.90
4 Circuit separators	Dark grey <input type="checkbox"/>	CS-R3	1SNK900107R0000	20	6.40	
5 Test adapters	Dark grey <input type="checkbox"/>	For test plugs DIA 2 mm 0.079 in	TP2	1SNK900203R0000	20	1.70
		For test plugs DIA 4 mm 0.157 in	TP4	1SNK900205R0000	20	2.40
6 Terminal block markers	White <input type="checkbox"/>	Blank marker	MG-CPM 13 41791	1SNB041791R0612	1680	0.27
		Blank card	MC812	1SNK160000R0000	22	10.00
			MC812PA	1SNK169999R0000	20	14.00
Universal wire markers holder	Grey <input type="checkbox"/>	UMH	1SNK900611R0000	10	0.20	

Complete list of accessories is indicated in the terminal block datasheet including end stops.

Some accessories such as jumper bars may modify the terminal block's ratings: Complete information available in the accessories section of the catalog.

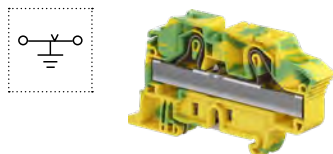

### Ground PI-Spring terminal blocks

Description	Color	Type	Part Number	Pkg qty	Weight (1 pce) g
Ground	Green-yellow <input type="checkbox"/>	ZK16-PE	1SNK712150R0000	20	47.00

Technical data valid for copper conductors only.

# ZK16-PV PI-Spring terminal blocks

## Feed-through - 14 mm 0.551 in spacing



1SNK16Z128V0014

ZK16-PV

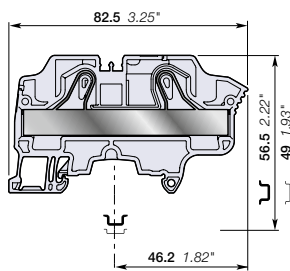

14 mm 0.551 in spacing

### Description

- Specially designed for high voltage utility scale solar power plants:
- Rated voltage of 1500 V DC IEC and 1000 V DC UL,
  - Pre-mounted end section with light grey color specific to this application,
  - Improved design with ribs to increase creepage distance,
  - Compact solution only 2 mm thicker than normal product,
  - No available jumpers for ZK16-PV and ZK16-3P-PV (14 mm spacing).

### Ordering details

Description	Color	Type	Part Number	Pkg qty	Weight (1 pce) g
Feed-through 2 connections	Grey <input type="checkbox"/>	ZK16-PV	1SNK712063R0000	15	36.56
	Blue <input type="checkbox"/>	ZK16-PV-BL	1SNK712065R0000	15	36.56

### Main technical data

Connecting capacity	IEC	UL - CSA	Mounting instructions		
1 conductor per clamp	Rigid: Solid/Stranded	0.5 ... 25 mm <sup>2</sup>	20 ... 4 AWG	Rail	TH 35-7.5, TH 35-15
	Flexible without ferrule	0.5 ... 16 mm <sup>2</sup>	20 ... 4 AWG	Wire stripping length	15 mm 0.591 in
	Flexible with non insulated ferrule	0.5 ... 16 mm <sup>2</sup>	20 ... 6 AWG	Tool (for flexible conductor without ferrule)	Flat screwdriver Ø 4 mm Ø 0.157 in
	Flexible with insulated ferrule	0.5 ... 16 mm <sup>2</sup>	20 ... 6 AWG		
2 conductors per clamp	Flexible with twin ferrule	0.5 ... 6 AWG	20 ... 10 AWG		
Rated current / Rated cross section		76 A / 16 mm <sup>2</sup>	75 A / 4 AWG		
Rated short-time withstand current (1s)		1920 A	2544 A		
Short Circuit Current Rating (with specific conditions)			100 kA		
Rated voltage		1000 V AC / 1500 V DC	1000 V		
Impulse withstand voltage		8000 V			
Protection		IP20	NEMA 1		

The connecting capacity data for one Rigid: Solid/Stranded, or one Flexible conductor (when applicable) is a mandatory information required by IEC, UL and CSA standards (Copper conductors). All other data are provided as supplementary information only. For more details, please consult our CB, UL or CSA certificates and technical datasheet available on <http://www.TE.com>

CE	CB	RoHS	UL	CSA	EAC				

### Accessories

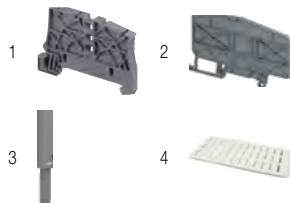

Description	Color	Type	Part Number	Pkg qty	Weight (1 pce) g
1 End stops	Dark grey <input type="checkbox"/>	BAZ1	1SNK900002R0000	50	5.30
2 Circuit separators	Dark grey <input type="checkbox"/>	CS-R3	1SNK900107R0000	20	6.40
3 Test adapters	Dark grey <input type="checkbox"/>	TP2	1SNK900203R0000	20	1.70
		TP4	1SNK900205R0000	20	2.40
4 Terminal block markers	White <input type="checkbox"/>	MC812	1SNK160000R0000	22	10.00
		MC812PA	1SNK169999R0000	20	14.00
		MG-CPM 13 41791	1SNB041791R0612	1680	0.273
	Grey <input type="checkbox"/>	UMH	1SNK900611R0000	10	0.20

Complete list of accessories is indicated in the terminal block datasheet including end stops. Some accessories such as jumper bars may modify the terminal block's ratings. Complete information available in the accessories section of the catalog.

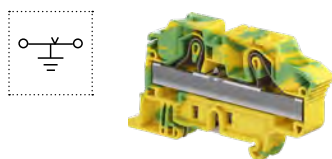

### Ground PI-Spring terminal blocks

Description	Color	Type	Part Number	Pkg qty	Weight (1 pce) g
Ground	Green-yellow <input type="checkbox"/>	ZK16-PE	1SNK712150R0000	20	47.00

Technical data valid for copper conductors only.



# ZK16-3P PI-Spring terminal blocks

Feed-through with 3 connections - 12 mm 0.472 in spacing



16 mm<sup>2</sup>  
4 AWG

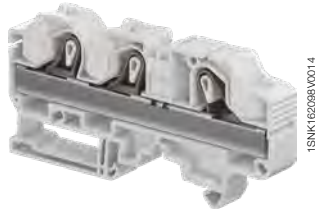

ZK16-3P

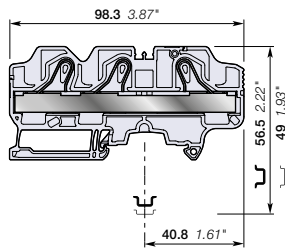

12 mm 0.472 in spacing

## Description

- Find all the features of the ZK16 terminal block with the added option of distributing or branching 3 conductors,
- ZK16-3P is perfectly adapted to solar applications: 1250 V DC (1000 V AC) IEC, 1000 V UL.

## Ordering details

Description	Color	Type	Part Number	Pkg qty	Weight (1 pce) g
Feed-through 3 connections	Grey <input type="checkbox"/>	ZK16-3P	1SNK712011R0000	20	44.3
	Blue <input type="checkbox"/>	ZK16-3P-BL	1SNK712021R0000	20	44.3

## Main technical data

Connecting capacity	IEC	UL - CSA	Rail	TH 35-7.5, TH 35-15
1 conductor per clamp	Rigid: Solid/Stranded	0.5 ... 25 mm <sup>2</sup>	20 ... 4 AWG	15 mm 0.591 in
	Flexible without ferrule	0.5 ... 16 mm <sup>2</sup>		
	Flexible with non insulated ferrule	0.5 ... 16 mm <sup>2</sup>	20 ... 6 AWG	
	Flexible with insulated ferrule	0.5 ... 16 mm <sup>2</sup>	20 ... 6 AWG	
2 conductors per clamp	Flexible with twin ferrule	0.5 ... 6 mm <sup>2</sup>	20 ... 10 AWG	Flat screwdriver Ø 4 mm Ø 0.157 in
Rated current / Rated cross section		76 A / 16 mm <sup>2</sup>	75 A / 4 AWG	
Rated short-time withstand current (1s)		1920 A		
Short Circuit Current Rating (with specific conditions)			100 kA	
Rated voltage		1000 V	1000 V	
Impulse withstand voltage		8000 V		
Protection		IP20	NEMA 1	
Increased safety Ex e		693 V 76 A - IM2 II 2 GD Ex eb I/II/III C		

The connecting capacity data for one Rigid: Solid/Stranded, or one Flexible conductor (when applicable) is a mandatory information required by IEC, UL and CSA standards (Copper conductors). All other data are provided as supplementary information only. For more details, please consult our CB, UL or CSA certificates and technical datasheet available on <http://www.TE.com>

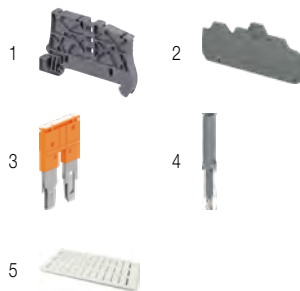

## Accessories

Description	Color	Type	Part Number	Pkg qty	Weight (1 pce) g	
1 End stops	Dark grey <input type="checkbox"/>	BAZ1	1SNK900002R0000	50	5.30	
2 End sections	Dark grey <input type="checkbox"/>	EK10-3P	1SNK710911R0000	20	4.5	
3 Jumper bars	Orange <input type="checkbox"/>	2 poles	JB12-2	1SNK912302R0000	50	4.90
		3 poles	JB12-3	1SNK912303R0000	50	7.60
		5 poles	JB12-5	1SNK912305R0000	20	12.90
4 Test adapters	Dark grey <input type="checkbox"/>	For test plugs DIA 2 mm 0.079 in	TP2	1SNK900203R0000	20	1.70
		For test plugs DIA 4 mm 0.157 in	TP4	1SNK900205R0000	20	2.40
5 Terminal block markers	White <input type="checkbox"/>	Blank marker	MG-CPM 13 41791	1SNB041791R0612	1680	0.27
		Blank card	MC812	1SNK160000R0000	22	10.00
		Universal wire markers holder	MC812PA	1SNK169999R0000	20	14.00
	Grey <input type="checkbox"/>	UMH	1SNK900611R0000	10	0.20	

Complete list of accessories is indicated in the terminal block datasheet including end stops.

Some accessories such as jumper bars may modify the terminal block's ratings: Complete information available in the accessories section of the catalog.

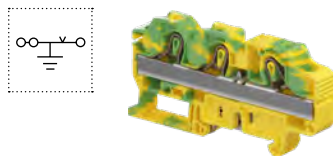

## Ground PI-Spring terminal blocks

Description	Color	Type	Part Number	Pkg qty	Weight (1 pce) g
Ground	Green-yellow <input type="checkbox"/>	ZK16-PE-3P	1SNK712151R0000	20	56.65

Technical data valid for copper conductors only.

# ZK16-3P-PV PI-Spring terminal blocks

Feed-through with 3 connections - 14 mm 0.551 in spacing



1SNK162130V0014

ZK16-3P-PV

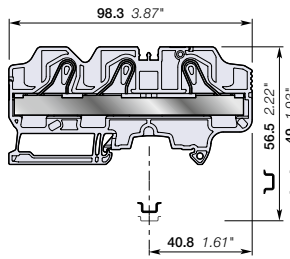

14 mm 0.551 in spacing

## Description

Specially designed for high voltage utility scale solar power plants:

- Rated voltage of 1500 V DC IEC and 1000 V DC UL,
- Pre-mounted end section with light grey color specific to this application,
- Improved design with ribs to increase creepage distance,
- Compact solution only 2 mm thicker than normal product,
- 3 connections configuration for easy grouping: 2 inputs / 1 output or 1 input / 2 outputs,
- No available jumpers for ZK16-PV and ZK16-3P-PV (14 mm spacing).

## Ordering details

Description	Color	Type	Part Number	Pkg qty	Weight (1 pce) g
Feed-through 3 connections	Grey <input type="checkbox"/>	ZK16-3P-PV	1SNK712064R0000	15	48.01
	Blue <input type="checkbox"/>	ZK16-3P-PV-BL	1SNK712067R0000	15	48.01

## Main technical data

Connecting capacity		IEC	UL - CSA	Mounting instructions	
1 conductor per clamp	Rigid: Solid/Stranded	0.5 ... 25 mm²	20 ... 4 AWG	Rail	TH 35-7.5, TH 35-15
	Flexible without ferrule	0.5 ... 16 mm²		Wire stripping length	15 mm 0.591 in
	Flexible with non insulated ferrule	0.5 ... 16 mm²	20 ... 6 AWG		
	Flexible with insulated ferrule	0.5 ... 16 mm²	20 ... 6 AWG		
2 conductors per clamp	Flexible with twin ferrule	0.5 ... 6 AWG	20 ... 10 AWG	Tool (for flexible conductor without ferrule)	Flat screwdriver Ø 4 mm Ø 0.157 in
Rated current / Rated cross section		76 A / 16 mm²	75 A / 4 AWG		
Rated short-time withstand current (1s)		1920 A	2544 A		
Short Circuit Current Rating (with specific conditions)			100 kA		
Rated voltage		1000 V AC / 1500 V DC	1000 V		
Impulse withstand voltage		8000 V			
Protection		IP20	NEMA 1		

The connecting capacity data for one Rigid: Solid/Stranded, or one Flexible conductor (when applicable) is a mandatory information required by IEC, UL and CSA standards (Copper conductors). All other data are provided as supplementary information only. For more details, please consult our CB, UL or CSA certificates and technical datasheet available on <http://www.TE.com>

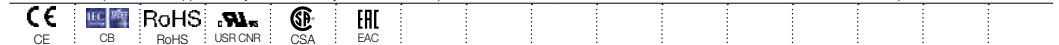

## Accessories

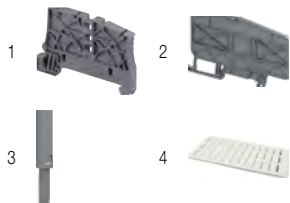

Description	Color	Type	Part Number	Pkg qty	Weight (1 pce) g
1 End stops 5.2 mm 0.205 in	Dark grey <input type="checkbox"/>	BAZ1	1SNK900002R0000	50	5.30
2 Circuit separators 3 mm 0.118 in	Dark grey <input type="checkbox"/>	CS-R3	1SNK900107R0000	20	6.40
3 Test adapters For test plugs DIA 2 mm 0.079 in	Dark grey <input type="checkbox"/>	TP2	1SNK900203R0000	20	1.70
		TP4	1SNK900205R0000	20	2.40
4 Terminal block markers	White <input type="checkbox"/>	MC812	1SNK160000R0000	22	10.00
		MC812PA	1SNK169999R0000	20	14.00
	Grey <input type="checkbox"/>	MG-CPM 13 41791	1SNB041791R0612	1680	0.273
		UMH	1SNK900611R0000	10	0.20

Complete list of accessories is indicated in the terminal block datasheet including end stops.

Some accessories such as jumper bars may modify the terminal block's ratings: Complete information available in the accessories section of the catalog.



## Ground PI-Spring terminal blocks

Description	Color	Type	Part Number	Pkg qty	Weight (1 pce) g
Ground Profile aligned with ZK16-3P	Green-yellow <input type="checkbox"/>	ZK16-PE-3P	1SNK712151R0000	20	56.65

1SNK162035S0201

Technical data valid for copper conductors only.



# ZK2.5-PE PI-Spring terminal blocks

Ground - 5.2 mm 0.205 in spacing



ZK2.5-PE

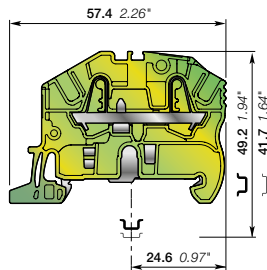

5.2 mm 0.205 in spacing

## Description

Improve the safety of your installation in the event of a short-circuit thanks to our screwless rail contact:

- Rail contact non operator dependent,
- Performances above the requirements of the IEC 60947-7-2 terminal block standard,
- Secured snap on or off the rail,
- Profile aligned with ZK2.5.

## Ordering details

Description	Color	Type	Part Number	Pkg qty	Weight (1 pce) g
Ground 2 connections	Green-yellow	ZK2.5-PE	1SNK705150R0000	20	10.00

## Main technical data

Connecting capacity		IEC	UL - CSA	Mounting instructions
1 conductor per clamp	Rigid: Solid/Stranded	0.2 ... 4 mm <sup>2</sup>	26 ... 12 AWG	Rail
	Flexible without ferrule	0.22 ... 2.5 mm <sup>2</sup>		Wire stripping length
	Flexible with non insulated ferrule	0.22 ... 2.5 mm <sup>2</sup>	26 ... 14 AWG	
	Flexible with insulated ferrule	0.22 ... 2.5 mm <sup>2</sup>	26 ... 14 AWG	
Rated cross section		2.5 mm <sup>2</sup>	12 AWG	Tool (for flexible conductor without ferrule)
Rated short-time withstand current (1s)		300 A	396 A	Flat screwdriver Ø 3.5 mm Ø 0.138 in
Protection		IP20	NEMA 1	
Explosive atmosphere classification		IM2 II 2 GD Ex eb I/IC/IIIC - Class I, Zone 1, AEx e II, Ex e II U		

The connecting capacity data for one Rigid: Solid/Stranded, or one Flexible conductor (when applicable) is a mandatory information required by IEC, UL and CSA standards (Copper conductors). All other data are provided as supplementary information only. For more details, please consult our CB, UL or CSA certificates and technical datasheet available on <http://www.TE.com>



## Accessories

Description	Color	Type	Part Number	Pkg qty	Weight (1 pce) g
1 End stops	Dark grey	BAZ1	1SNK900002R0000	50	5.30
2 End sections	Dark grey	EK2.5	1SNK705910R0000	20	1.80
3 Circuit separators	Dark grey	CS-R2	1SNK900106R0000	20	3.80
4 Terminal block markers	White	MG-CPM 13 41790	1SNB041790R0512	1960	0.23
		MC512	1SNK140000R0000	22	9.00
		MC512PA	1SNK149999R0000	20	10.00
Universal wire markers holder	Grey	UMH	1SNK900611R0000	10	0.20

Complete list of accessories is indicated in the terminal block datasheet including end stops.

Some accessories such as jumper bars may modify the terminal block's ratings: Complete information available in the accessories section of the catalog.

Technical data valid for copper conductors only.

# ZK2.5-PE-3P PI-Spring terminal blocks

Ground with 3 connections - 5.2 mm 0.205 in spacing



1SNK162046S0201

ZK2.5-PE-3P

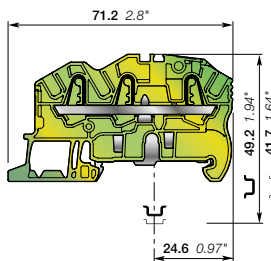

5.2 mm 0.205 in spacing

## Description

Improve the safety of your installation in the event of a short-circuit thanks to our screwless rail contact:

- Rail contact non operator dependent,
- Performances above the requirements of the IEC 60947-7-2 terminal block standard,
- Secured snap on or off the rail,
- Profile aligned with ZK2.5-3P.

## Ordering details

Description	Color	Type	Part Number	Pkg qty	Weight (1 pce) g
Ground 3 connections	Green-yellow	ZK2.5-PE-3P	1SNK705151R0000	20	11.90

## Main technical data

Connecting capacity	IEC	UL - CSA	Mounting instructions		
1 conductor per clamp	Rigid: Solid/Stranded	0.2 ... 4 mm <sup>2</sup>	26 ... 12 AWG	Rail	TH 35-7.5, TH 35-15
	Flexible without ferrule	0.22 ... 2.5 mm <sup>2</sup>	26 ... 14 AWG	Wire stripping length	11 mm 0.433 in
	Flexible with non insulated ferrule	0.22 ... 2.5 mm <sup>2</sup>	26 ... 14 AWG	Tool (for flexible conductor without ferrule)	Flat screwdriver Ø 3.5 mm Ø 0.138 in
	Flexible with insulated ferrule	0.22 ... 2.5 mm <sup>2</sup>	26 ... 14 AWG		
<b>Rated cross section</b>		2.5 mm <sup>2</sup>	12 AWG		
<b>Rated short-time withstand current (1s)</b>		300 A	396 A		
<b>Protection</b>		IP20	NEMA 1		
<b>Explosive atmosphere classification</b>		IM2 II 2 GD Ex eb I/IC/IIC - Class I, Zone 1, AEx e II, Ex e II U			

The connecting capacity data for one Rigid: Solid/Stranded, or one Flexible conductor (when applicable) is a mandatory information required by IEC, UL and CSA standards (Copper conductors). All other data are provided as supplementary information only. For more details, please consult our CB, UL or CSA certificates and technical datasheet available on <http://www.TE.com>

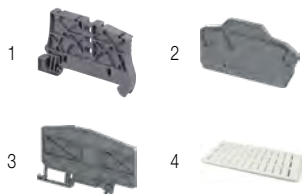

## Accessories

Description	Color	Type	Part Number	Pkg qty	Weight (1 pce) g
1 End stops	Dark grey	BAZ1	1SNK900002R0000	50	5.30
2 End sections	Dark grey	EK2.5-3P	1SNK705911R0000	20	2.40
3 Circuit separators	Dark grey	CS-R3	1SNK900107R0000	20	6.40
4 Terminal block markers	White	MG-CPM 13 41790	1SNB041790R0512	1960	0.23
		MC512	1SNK140000R0000	22	9.00
		MC512PA	1SNK149999R0000	20	10.00
Universal wire markers holder	Grey	UMH	1SNK900611R0000	10	0.20

Complete list of accessories is indicated in the terminal block datasheet including end stops. Some accessories such as jumper bars may modify the terminal block's ratings. Complete information available in the accessories section of the catalog.

Technical data valid for copper conductors only.

# ZK2.5-PE-4P PI-Spring terminal blocks

Ground with 4 connections - 5.2 mm 0.205 in spacing



ZK2.5-PE-4P

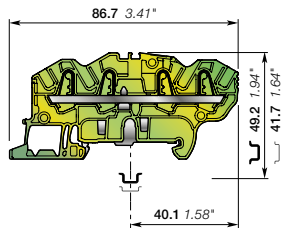

5.2 mm 0.205 in spacing

## Description

Improve the safety of your installation in the event of a short-circuit thanks to our screwless rail contact:

- Rail contact non operator dependent,
- Performances above the requirements of the IEC 60947-7-2 terminal block standard,
- Secured snap on or off the rail,
- Profile aligned with ZK2.5-4P.

## Ordering details

Description	Color	Type	Part Number	Pkg qty	Weight (1 pce) g
Ground 4 connections	Green-yellow	ZK2.5-PE-4P	1SNK705152R0000	20	13.60

## Main technical data

Connecting capacity		IEC	UL - CSA	Mounting instructions	
1 conductor per clamp	Rigid: Solid/Stranded	0.2 ... 4 mm <sup>2</sup>	26 ... 12 AWG	Rail	TH 35-7.5, TH 35-15
	Flexible without ferrule	0.22 ... 2.5 mm <sup>2</sup>	26 ... 14 AWG	Wire stripping length	11 mm 0.433 in
	Flexible with non insulated ferrule	0.22 ... 2.5 mm <sup>2</sup>	26 ... 14 AWG		
	Flexible with insulated ferrule	0.22 ... 2.5 mm <sup>2</sup>	26 ... 14 AWG	Tool (for flexible conductor without ferrule)	Flat screwdriver Ø 3.5 mm Ø 0.138 in
Rated cross section		2.5 mm <sup>2</sup>	12 AWG		
Rated short-time withstand current (1s)		300 A	396 A		
Protection		IP20	NEMA 1		
Explosive atmosphere classification		IM2 II 2 GD Ex eb I/IC/IIIC - Class I, Zone 1, AEx e II, Ex e II U			

The connecting capacity data for one Rigid: Solid/Stranded, or one Flexible conductor (when applicable) is a mandatory information required by IEC, UL and CSA standards (Copper conductors). All other data are provided as supplementary information only. For more details, please consult our CB, UL or CSA certificates and technical datasheet available on <http://www.TE.com>



## Accessories

Description	Color	Type	Part Number	Pkg qty	Weight (1 pce) g
1 End stops	Dark grey	BAZ1	1SNK900002R0000	50	5.30
2 End sections	Dark grey	EK2.5-4P	1SNK705912R0000	20	2.70
3 Circuit separators	Dark grey	CS-R3	1SNK900107R0000	20	6.40
4 Terminal block markers	White	MG-CPM 13 41790	1SNB041790R0512	1960	0.23
		MC512	1SNK140000R0000	22	9.00
		MC512PA	1SNK149999R0000	20	10.00
Universal wire markers holder	Grey	UMH	1SNK900611R0000	10	0.20

Complete list of accessories is indicated in the terminal block datasheet including end stops.

Some accessories such as jumper bars may modify the terminal block's ratings: Complete information available in the accessories section of the catalog.

Technical data valid for copper conductors only.

# ZK4-PE PI-Spring terminal blocks

Ground - 6 mm 0.236 in spacing



1SNK16206800014

ZK4-PE

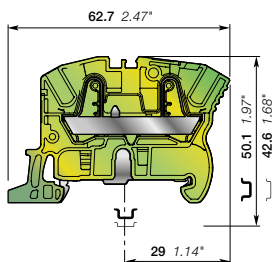

6 mm 0.236 in spacing

## Description

Improve the safety of your installation in the event of a short-circuit thanks to our screwless rail contact:

- Rail contact non operator dependent,
- Performances above the requirements of the IEC 60947-7-2 terminal block standard,
- Secured snap on or off the rail,
- Profile aligned with ZK4.

## Ordering details

Description	Color	Type	Part Number	Pkg qty	Weight (1 pce) g
Ground 2 connections	Green-yellow	ZK4-PE	1SNK706150R0000	20	12.60

## Main technical data

Connecting capacity	IEC	UL - CSA	Mounting instructions		
1 conductor per clamp	Rigid: Solid/Stranded	0.5 ... 6 mm <sup>2</sup>	26 ... 10 AWG	Rail	TH 35-7.5, TH 35-15
	Flexible without ferrule	0.5 ... 4 mm <sup>2</sup>	26 ... 12 AWG	Wire stripping length	12.5 mm 0.492 in
	Flexible with non insulated ferrule	0.5 ... 4 mm <sup>2</sup>	26 ... 12 AWG	Tool (for flexible conductor without ferrule)	Flat screwdriver Ø 3.5 mm Ø 0.138 in
	Flexible with insulated ferrule	0.5 ... 4 mm <sup>2</sup>	26 ... 12 AWG		
<b>Rated cross section</b>		4 mm <sup>2</sup>	10 AWG		
<b>Rated short-time withstand current (1s)</b>		480 A	636 A		
<b>Protection</b>		IP20	NEMA 1		
<b>Explosive atmosphere classification</b>		IM2 II 2 GD Ex eb I/IC/IIIC - Class I, Zone 1, AEx e II, Ex e II U			

The connecting capacity data for one Rigid: Solid/Stranded, or one Flexible conductor (when applicable) is a mandatory information required by IEC, UL and CSA standards (Copper conductors). All other data are provided as supplementary information only. For more details, please consult our CB, UL or CSA certificates and technical datasheet available on <http://www.TE.com>



## Accessories

Description	Color	Type	Part Number	Pkg qty	Weight (1 pce) g
1 End stops	Dark grey	BAZ1	1SNK900002R0000	50	5.30
2 End sections	Dark grey	EK2.5	1SNK705910R0000	20	1.80
3 Circuit separators	Dark grey	CS-R2	1SNK900106R0000	20	3.80
4 Terminal block markers	White	MG-CPM 13 41791	1SNB041791R0612	1680	0.27
		MC612	1SNK150000R0000	22	10.00
		MC612PA	1SNK159999R0000	20	11.00
Universal wire markers holder	Grey	UMH	1SNK900611R0000	10	0.20

Complete list of accessories is indicated in the terminal block datasheet including end stops. Some accessories such as jumper bars may modify the terminal block's ratings. Complete information available in the accessories section of the catalog.

Technical data valid for copper conductors only.

# ZK4-PE-3P PI-Spring terminal blocks

Ground with 3 connections - 6 mm 0.236 in spacing



ZK4-PE-3P

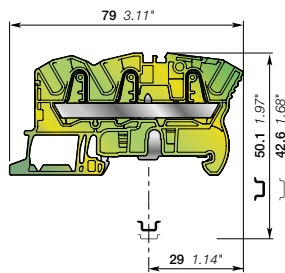

6 mm 0.236 in spacing

## Description

Improve the safety of your installation in the event of a short-circuit thanks to our screwless rail contact:

- Rail contact non operator dependent,
- Performances above the requirements of the IEC 60947-7-2 terminal block standard,
- Secured snap on or off the rail,
- Profile aligned with ZK4-3P.

## Ordering details

Description	Color	Type	Part Number	Pkg qty	Weight (1 pce) g
Ground 3 connections	Green-yellow	ZK4-PE-3P	1SNK706151R0000	20	15.70

## Main technical data

Connecting capacity		IEC	UL - CSA	Mounting instructions	
1 conductor per clamp	Rigid: Solid/Stranded	0.5 ... 6 mm <sup>2</sup>	26 ... 10 AWG	Rail	TH 35-7.5, TH 35-15
	Flexible without ferrule	0.5 ... 4 mm <sup>2</sup>	26 ... 12 AWG	Wire stripping length	12.5 mm 0.492 in
	Flexible with non insulated ferrule	0.5 ... 4 mm <sup>2</sup>	26 ... 12 AWG		
	Flexible with insulated ferrule	0.5 ... 4 mm <sup>2</sup>	26 ... 12 AWG	Tool (for flexible conductor without ferrule)	Flat screwdriver Ø 3.5 mm Ø 0.138 in
Rated cross section		4 mm <sup>2</sup>	10 AWG		
Rated short-time withstand current (1s)		480 A	636 A		
Protection		IP20	NEMA 1		
Explosive atmosphere classification		IM2 II 2 GD Ex eb I/IC/IIIC - Class I, Zone 1, AEx e II, Ex e II U			

The connecting capacity data for one Rigid: Solid/Stranded, or one Flexible conductor (when applicable) is a mandatory information required by IEC, UL and CSA standards (Copper conductors). All other data are provided as supplementary information only. For more details, please consult our CB, UL or CSA certificates and technical datasheet available on <http://www.TE.com>



## Accessories

Description	Color	Type	Part Number	Pkg qty	Weight (1 pce) g
1 End stops	Dark grey	BAZ1	1SNK900002R0000	50	5.30
2 End sections	Dark grey	EK2.5-3P	1SNK705911R0000	20	2.40
3 Circuit separators	Dark grey	CS-R3	1SNK900107R0000	20	6.40
4 Terminal block markers	White	MG-CPM 13 41791	1SNB041791R0612	1680	0.27
		MC612	1SNK150000R0000	22	10.00
		MC612PA	1SNK159999R0000	20	11.00
Universal wire markers holder	Grey	UMH	1SNK900611R0000	10	0.20

Complete list of accessories is indicated in the terminal block datasheet including end stops.

Some accessories such as jumper bars may modify the terminal block's ratings: Complete information available in the accessories section of the catalog.

Technical data valid for copper conductors only.

# ZK4-PE-4P PI-Spring terminal blocks

Ground with 4 connections - 6 mm 0.236 in spacing



ZK4-PE-4P

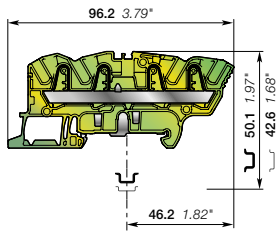

6 mm 0.236 in spacing

## Description

Improve the safety of your installation in the event of a short-circuit thanks to our screwless rail contact:

- Rail contact non operator dependent,
- Performances above the requirements of the IEC 60947-7-2 terminal block standard,
- Secured snap on or off the rail,
- Profile aligned with ZK4-4P.

## Ordering details

Description	Color	Type	Part Number	Pkg qty	Weight (1 pce) g
Ground 4 connections	Green-yellow	ZK4-PE-4P	1SNK706152R0000	20	18.40

## Main technical data

Connecting capacity	IEC	UL - CSA	Rail	Wire stripping length	Tool (for flexible conductor without ferrule)
1 conductor per clamp	Rigid: Solid/Stranded	0.5 ... 6 mm <sup>2</sup>	26 ... 10 AWG		
	Flexible without ferrule	0.5 ... 4 mm <sup>2</sup>	26 ... 12 AWG		
	Flexible with non insulated ferrule	0.5 ... 4 mm <sup>2</sup>	26 ... 12 AWG		
	Flexible with insulated ferrule	0.5 ... 4 mm <sup>2</sup>	26 ... 12 AWG		
<b>Rated cross section</b>	4 mm <sup>2</sup>	10 AWG			
<b>Rated short-time withstand current (1s)</b>	480 A	636 A			
<b>Protection</b>	IP20	NEMA 1			
<b>Explosive atmosphere classification</b>	IM2 II 2 GD Ex eb I/II C - Class I, Zone 1, AEx e II, Ex e II U				

The connecting capacity data for one Rigid: Solid/Stranded, or one Flexible conductor (when applicable) is a mandatory information required by IEC, UL and CSA standards (Copper conductors). All other data are provided as supplementary information only. For more details, please consult our CB, UL or CSA certificates and technical datasheet available on <http://www.TE.com>



## Accessories

Description	Color	Type	Part Number	Pkg qty	Weight (1 pce) g
1 End stops	Dark grey	BAZ1	1SNK900002R0000	50	5.30
2 End sections	Dark grey	EK2 5-4P	1SNK705912R0000	20	2.70
3 Circuit separators	Dark grey	CS-R3	1SNK900107R0000	20	6.40
4 Terminal block markers	White	MG-CPM 13 41791	1SNB041791R0612	1680	0.27
		MC612	1SNK150000R0000	22	10.00
		MC612PA	1SNK159999R0000	20	11.00
Universal wire markers holder	Grey	UMH	1SNK900611R0000	10	0.20

Complete list of accessories is indicated in the terminal block datasheet including end stops. Some accessories such as jumper bars may modify the terminal block's ratings. Complete information available in the accessories section of the catalog.

Technical data valid for copper conductors only.



# ZK6-PE PI-Spring terminal blocks

Ground - 8 mm 0.315 in spacing



ZK6-PE

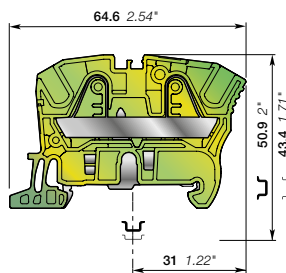

8 mm 0.315 in spacing

## Description

Improve the safety of your installation in the event of a short-circuit thanks to our screwless rail contact:

- Rail contact non operator dependent,
- Performances above the requirements of the IEC 60947-7-2 terminal block standard,
- Secured snap on or off the rail,
- Profile aligned with ZK6.

## Ordering details

Description	Color	Type	Part Number	Pkg qty	Weight (1 pce) g
Ground 2 connections	Green-yellow	ZK6-PE	1SNK708150R0000	20	20.30

## Main technical data

Connecting capacity		IEC	UL - CSA	Mounting instructions	
1 conductor per clamp	Rigid: Solid/Stranded	0.5 ... 10 mm <sup>2</sup>	24 ... 8 AWG	Rail	TH 35-7.5, TH 35-15
	Flexible without ferrule	0.5 ... 6 mm <sup>2</sup>	24 ... 8 AWG	Wire stripping length	12.5 mm 0.492 in
	Flexible with non insulated ferrule	0.5 ... 6 mm <sup>2</sup>	24 ... 10 AWG		
	Flexible with insulated ferrule	0.5 ... 6 mm <sup>2</sup>	24 ... 10 AWG	Tool (for flexible conductor without ferrule)	Flat screwdriver Ø 3.5 mm Ø 0.138 in
Rated cross section		6 mm <sup>2</sup>	8 AWG		
Rated short-time withstand current (1s)		720 A	1008 A		
Protection		IP20	NEMA 1		
Explosive atmosphere classification		IM2 II 2 GD Ex eb I/IC/IIIC - Class I, Zone 1, AEx e II, Ex e II U			

The connecting capacity data for one Rigid: Solid/Stranded, or one Flexible conductor (when applicable) is a mandatory information required by IEC, UL and CSA standards (Copper conductors). All other data are provided as supplementary information only. For more details, please consult our CB, UL or CSA certificates and technical datasheet available on <http://www.TE.com>



## Accessories

Description	Color	Type	Part Number	Pkg qty	Weight (1 pce) g
1 End stops	Dark grey	BAZ1	1SNK900002R0000	50	5.30
2 End sections	Dark grey	EK2.5	1SNK705910R0000	20	1.80
3 Circuit separators	Dark grey	CS-R2	1SNK900106R0000	20	3.80
4 Terminal block markers	White	MG-CPM 13 41791	1SNB041791R0612	1680	0.27
		MC812	1SNK160000R0000	22	10.00
		MC812PA	1SNK169999R0000	20	14.00
Universal wire markers holder	Grey	UMH	1SNK900611R0000	10	0.20

Complete list of accessories is indicated in the terminal block datasheet including end stops.

Some accessories such as jumper bars may modify the terminal block's ratings: Complete information available in the accessories section of the catalog.

Technical data valid for copper conductors only.

# ZK6-PE-3P PI-Spring terminal blocks

Ground with 3 connections - 8 mm 0.315 in spacing



1SNK162026V0014

ZK6-PE-3P

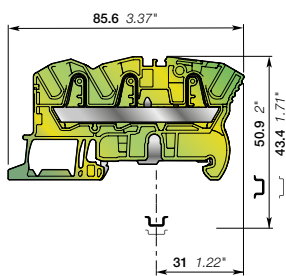

8 mm 0.315 in spacing

## Description

Improve the safety of your installation in the event of a short-circuit thanks to our screwless rail contact:

- Rail contact non operator dependent,
- Performances above the requirements of the IEC 60947-7-2 terminal block standard,
- Secured snap on or off the rail,
- Profile aligned with ZK6-3P.

## Ordering details

Description	Color	Type	Part Number	Pkg qty	Weight (1 pce) g
Ground 3 connections	Green-yellow	ZK6-PE-3P	1SNK708151R0000	20	21.50

## Main technical data

Connecting capacity		IEC	UL - CSA	Mounting instructions	
1 conductor per clamp	Rigid: Solid/Stranded	0.5 ... 10 mm <sup>2</sup>	24 ... 8 AWG	Rail	TH 35-7.5, TH 35-15
	Flexible without ferrule	0.5 ... 6 mm <sup>2</sup>	24 ... 8 AWG	Wire stripping length	12.5 mm 0.492 in
	Flexible with non insulated ferrule	0.5 ... 6 mm <sup>2</sup>	24 ... 10 AWG		Tool (for flexible conductor without ferrule)
	Flexible with insulated ferrule	0.5 ... 6 mm <sup>2</sup>	24 ... 10 AWG		
<b>Rated cross section</b>		6 mm <sup>2</sup>	8 AWG		
<b>Rated short-time withstand current (1s)</b>		720 A	1008 A		
<b>Protection</b>		IP20	NEMA 1		
<b>Explosive atmosphere classification</b>		IM2 II 2 GD Ex eb I/IC/IIC - Class I, Zone 1, AEx e II, Ex e II U			

The connecting capacity data for one Rigid: Solid/Stranded, or one Flexible conductor (when applicable) is a mandatory information required by IEC, UL and CSA standards (Copper conductors). All other data are provided as supplementary information only. For more details, please consult our CB, UL or CSA certificates and technical datasheet available on <http://www.TE.com>



## Accessories

Description	Color	Type	Part Number	Pkg qty	Weight (1 pce) g
1 End stops	Dark grey	BAZ1	1SNK900002R0000	50	5.30
2 End sections	Dark grey	EK6-3P	1SNK708911R0000	20	2.80
3 Circuit separators	Dark grey	CS-R3	1SNK900107R0000	20	6.40
4 Terminal block markers	White	MG-CPM 13 41791	1SNB041791R0612	1680	0.27
		MC812	1SNK160000R0000	22	10.00
		MC812PA	1SNK169999R0000	20	14.00
Universal wire markers holder	Grey	UMH	1SNK900611R0000	10	0.20

Complete list of accessories is indicated in the terminal block datasheet including end stops. Some accessories such as jumper bars may modify the terminal block's ratings. Complete information available in the accessories section of the catalog.

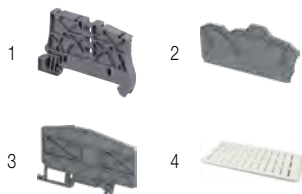

Technical data valid for copper conductors only.

# ZK10-PE PI-Spring terminal blocks

Ground - 10 mm 0.394 in spacing



ZK10-PE

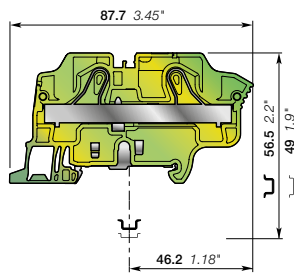

10 mm 0.394 in spacing

## Description

Improve the safety of your installation in the event of a short-circuit thanks to our screwless rail contact:

- Rail contact non operator dependent,
- Performances above the requirements of the IEC 60947-7-2 terminal block standard,
- Secured snap on or off the rail,
- Profile aligned with ZK10.

## Ordering details

Description	Color	Type	Part Number	Pkg qty	Weight (1 pce) g
Ground 2 connections	Green-yellow	ZK10-PE	1SNK710150R0000	20	36.20

## Main technical data

Connecting capacity		IEC	UL - CSA	Mounting instructions	
1 conductor per clamp	Rigid: Solid/Stranded	0.5 ... 16 mm <sup>2</sup>	20 ... 6 AWG	Rail	TH 35-7.5, TH 35-15
	Flexible without ferrule	0.5 ... 10 mm <sup>2</sup>	20 ... 8 AWG	Wire stripping length	15 mm 0.591 in
	Flexible with non insulated ferrule	0.5 ... 10 mm <sup>2</sup>	20 ... 8 AWG		
	Flexible with insulated ferrule	0.5 ... 10 mm <sup>2</sup>	20 ... 8 AWG	Tool (for flexible conductor without ferrule)	Flat screwdriver Ø 4 mm Ø 0.157 in
Rated cross section		10 mm <sup>2</sup>	6 AWG		
Rated short-time withstand current (1s)		1200 A	1596 A		
Protection		IP20	NEMA 1		
Explosive atmosphere classification		IM2 II 2 GD Ex eb I/IC/IIIC - Class I, Zone 1, AEx e II, Ex e II U			

The connecting capacity data for one Rigid: Solid/Stranded, or one Flexible conductor (when applicable) is a mandatory information required by IEC, UL and CSA standards (Copper conductors). All other data are provided as supplementary information only. For more details, please consult our CB, UL or CSA certificates and technical datasheet available on <http://www.TE.com>

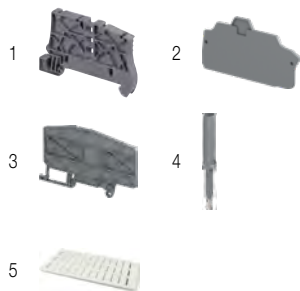

## Accessories

Description	Color	Type	Part Number	Pkg qty	Weight (1 pce) g
1 End stops	Dark grey	BAZ1	1SNK900002R0000	50	5.30
2 End sections	Dark grey	EK10	1SNK710910R0000	20	3.30
3 Circuit separators	Dark grey	CS-R3	1SNK900107R0000	20	6.40
4 Test adapters	Dark grey	TP2	1SNK900203R0000	20	1.70
		TP4	1SNK900205R0000	20	2.40
5 Terminal block markers	White	MG-CPM 13 41791	1SNB041791R0612	1680	0.27
		MC812	1SNK160000R0000	22	10.00
		MC812PA	1SNK169999R0000	20	14.00
		Universal wire markers holder	Grey	UMH	1SNK900611R0000

Complete list of accessories is indicated in the terminal block datasheet including end stops. Some accessories such as jumper bars may modify the terminal block's ratings: Complete information available in the accessories section of the catalog.

Technical data valid for copper conductors only.

# ZK10-PE-3P PI-Spring terminal blocks

Ground with 3 connections - 10 mm 0.394 in spacing



ZK10-PE-3P

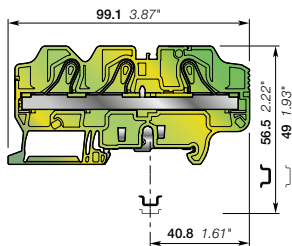

10 mm 0.394 in spacing

## Description

Improve the safety of your installation in the event of a short-circuit thanks to our screwless rail contact:

- Rail contact non operator dependent,
- Performances above the requirements of the IEC 60947-7-2 standard,
- Secured snap on or off the rail,
- Profile aligned with ZK10-3P.

## Ordering details

Description	Color	Type	Part Number	Pkg qty	Weight (1 pce)
Ground 3 connections	Green-yellow	ZK10-PE-3P	1SNK710151R0000	20	43.3 g

## Main technical data

Connecting capacity	IEC	UL - CSA	Rail	Wire stripping length	Tool (for flexible conductor without ferrule)
1 conductor per clamp	Rigid: Solid/Stranded	0.5 ... 16 mm <sup>2</sup>	20 ... 6 AWG	15 mm 0.591 in	Flat screwdriver Ø 4 mm Ø 0.157 in
	Flexible without ferrule	0.5 ... 10 mm <sup>2</sup>	20 ... 8 AWG		
	Flexible with non insulated ferrule	0.5 ... 10 mm <sup>2</sup>	20 ... 8 AWG		
	Flexible with insulated ferrule	0.5 ... 10 mm <sup>2</sup>	20 ... 8 AWG		
Rated cross section	10 mm <sup>2</sup>	6 AWG			
Rated short-time withstand current (1s)	1200 A	1596 A			
Protection	IP20	NEMA 1			
Explosive atmosphere classification	IM2 II 2 GD Ex eb I/II/III C				

The connecting capacity data for one Rigid: Solid/Stranded, or one Flexible conductor (when applicable) is a mandatory information required by IEC, UL and CSA standards (Copper conductors). All other data are provided as supplementary information only. For more details, please consult our CB, UL or CSA certificates and technical datasheet available on <http://www.TE.com>

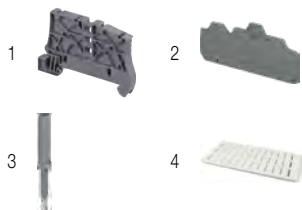

## Accessories

Description	Color	Type	Part Number	Pkg qty	Weight (1 pce)
1 End stops	Dark grey	BAZ1	1SNK900002R0000	50	5.30 g
2 End sections	Dark grey	EK10-3P	1SNK710911R0000	20	4.5 g
3 Test adapters	Dark grey	TP2	1SNK900203R0000	20	1.70 g
		TP4	1SNK900205R0000	20	2.40 g
4 Terminal block markers	White	MG-CPM 13 41791	1SNB041791R0612	1680	0.27 g
		MC812	1SNK160000R0000	22	10.00 g
		MC812PA	1SNK169999R0000	20	14.00 g
	Universal wire markers holder	Grey	UMH	1SNK900611R0000	10

Complete list of accessories is indicated in the terminal block datasheet including end stops.

Some accessories such as jumper bars may modify the terminal block's ratings: Complete information available in the accessories section of the catalog.

Technical data valid for copper conductors only.

# ZK16-PE PI-Spring terminal blocks

Ground - 12 mm 0.472 in spacing



16 mm<sup>2</sup>  
4 AWG



1SNK16208AV0014

ZK16-PE

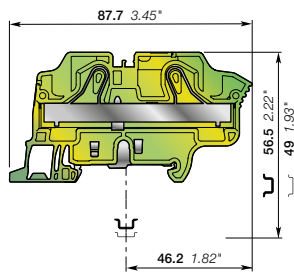

12 mm 0.472 in spacing

## Description

Improve the safety of your installation in the event of a short-circuit thanks to our screwless rail contact:

- Rail contact non operator dependent,
- Performances above the requirements of the IEC 60947-7-2 terminal block standard,
- Secured snap on or off the rail,
- Profile aligned with ZK16.

## Ordering details

Description	Color	Type	Part Number	Pkg qty	Weight (1 pce) g
Ground 2 connections	Green-yellow	ZK16-PE	1SNK712150R0000	20	47.00

## Main technical data

Connecting capacity		IEC	UL - CSA	Mounting instructions	
1 conductor per clamp	Rigid: Solid/Stranded	0.5 ... 25 mm <sup>2</sup>	20 ... 4 AWG	Rail	TH 35-7.5, TH 35-15
	Flexible without ferrule	0.5 ... 16 mm <sup>2</sup>	20 ... 6 AWG	Wire stripping length	15 mm 0.591 in
	Flexible with non insulated ferrule	0.5 ... 16 mm <sup>2</sup>	20 ... 6 AWG		
	Flexible with insulated ferrule	0.5 ... 16 mm <sup>2</sup>	20 ... 6 AWG	Tool (for flexible conductor without ferrule)	Flat screwdriver Ø 4 mm Ø 0.157 in
Rated cross section		16 mm <sup>2</sup>	4 AWG		
Rated short-time withstand current (1s)		1920 A	2544 A		
Protection		IP20	NEMA 1		
Explosive atmosphere classification		IM2 II 2 GD Ex eb I/IC/IIIC - Class I, Zone 1, AEx e II, Ex e II U			

The connecting capacity data for one Rigid: Solid/Stranded, or one Flexible conductor (when applicable) is a mandatory information required by IEC, UL and CSA standards (Copper conductors). All other data are provided as supplementary information only. For more details, please consult our CB, UL or CSA certificates and technical datasheet available on <http://www.TE.com>

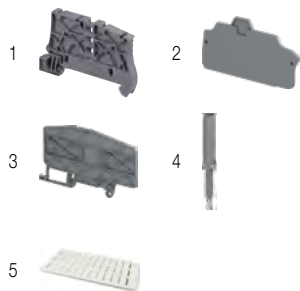

## Accessories

Description	Color	Type	Part Number	Pkg qty	Weight (1 pce) g
1 End stops	Dark grey	BAZ1	1SNK900002R0000	50	5.30
2 End sections	Dark grey	EK10	1SNK710910R0000	20	3.30
3 Circuit separators	Dark grey	CS-R3	1SNK900107R0000	20	6.40
4 Test adapters	Dark grey	TP2	1SNK900203R0000	20	1.70
		TP4	1SNK900205R0000	20	2.40
5 Terminal block markers	White	MG-CPM 13 41791	1SNB041791R0612	1680	0.27
		MC812	1SNK160000R0000	22	10.00
		MC812PA	1SNK169999R0000	20	14.00
		Universal wire markers holder	Grey	UMH	1SNK900611R0000

Complete list of accessories is indicated in the terminal block datasheet including end stops. Some accessories such as jumper bars may modify the terminal block's ratings: Complete information available in the accessories section of the catalog.

Technical data valid for copper conductors only.

# ZK16-PE-3P PI-Spring terminal blocks

Ground with 3 connections - 12 mm 0.472 in spacing



1SNK162100V0014

ZK16-PE-3P

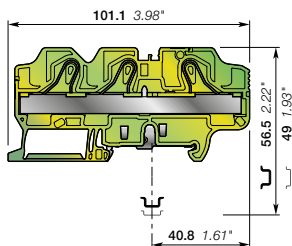

12 mm 0.472 in spacing

## Description

- Improve the safety of your installation in the event of a short-circuit thanks to our screwless rail contact:
- Rail contact non operator dependent,
  - Performances above the requirements of the IEC 60947-7-2 standard,
  - Secured snap on or off the rail,
  - Profile aligned with ZK16-3P.

## Ordering details

Description	Color	Type	Part Number	Pkg qty	Weight (1 pce) g
Ground 3 connections	Green-yellow	ZK16-PE-3P	1SNK712151R0000	20	56.65

## Main technical data

Connecting capacity	IEC	UL - CSA	Rail	Wire stripping length	Tool (for flexible conductor without ferrule)
1 conductor per clamp	Rigid: Solid/Stranded	0.5 ... 25 mm²	20 ... 4 AWG	15 mm 0.591 in	Flat screwdriver Ø 4 mm Ø 0.157 in
	Flexible without ferrule	0.5 ... 16 mm²	20 ... 6 AWG		
	Flexible with non insulated ferrule	0.5 ... 16 mm²	20 ... 6 AWG		
	Flexible with insulated ferrule	0.5 ... 16 mm²	20 ... 6 AWG		
Rated cross section	16 mm²	4 AWG			
Rated short-time withstand current (1s)	1920 A	2544 A			
Protection	IP20	NEMA 1			
Explosive atmosphere classification	IM2 II 2 GD Ex eb I/II/III C				

The connecting capacity data for one Rigid: Solid/Stranded, or one Flexible conductor (when applicable) is a mandatory information required by IEC, UL and CSA standards (Copper conductors). All other data are provided as supplementary information only. For more details, please consult our CB, UL or CSA certificates and technical datasheet available on <http://www.TE.com>



## Accessories

Description	Color	Type	Part Number	Pkg qty	Weight (1 pce) g
1 End stops	Dark grey	BAZ1	1SNK900002R0000	50	5.30
2 End sections	Dark grey	EK10-3P	1SNK710911R0000	20	4.5
3 Test adapters	Dark grey	TP2	1SNK900203R0000	20	1.70
		TP4	1SNK900205R0000	20	2.40
4 Terminal block markers	White	MG-CPM 13 41791	1SNB041791R0612	1680	0.27
		MC812	1SNK160000R0000	22	10.00
		MC812PA	1SNK169999R0000	20	14.00
	Universal wire markers holder	Grey	UMH	1SNK900611R0000	10

Complete list of accessories is indicated in the terminal block datasheet including end stops. Some accessories such as jumper bars may modify the terminal block's ratings: Complete information available in the accessories section of the catalog.

Technical data valid for copper conductors only.



# ZK2.5-S PI-Spring terminal blocks

Disconnect with blade - with test sockets - 5.2 mm 0.205 in spacing



ZK2.5-S

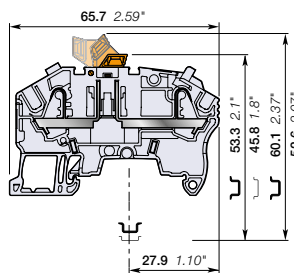

5.2 mm 0.205 in spacing

## Description

Combine high performance with compact dimensions: 630 V IEC 300 V UL.

Secure the current measurement:

- for currents below 50 mA, thanks to 2 built in test points DIA 2 mm 0.079 in,
- for currents up to 16 A, by using the TP4 test adapter inserted into the jumper channels.

## Ordering details

Description	Color	Type	Part Number	Pkg qty	Weight (1 pce) g
Disconnect with 2 test sockets DIA 2 mm 0.079 in	Grey	ZK2.5-S	1SNK705310R0000	50	8.10
	Blue	ZK2.5-S-BL	1SNK705320R0000	50	8.10
	Orange	ZK2.5-S-OR	1SNK705330R0000	50	8.10

## Main technical data

Connecting capacity		IEC	UL - CSA	Mounting instructions	
1 conductor per clamp	Rigid: Solid/Stranded	0.2 ... 4 mm²	26 ... 12 AWG	Rail	TH 35-7.5, TH 35-15
	Flexible without ferrule	0.22 ... 2.5 mm²		Wire stripping length	11 mm 0.433 in
	Flexible with non insulated ferrule	0.22 ... 2.5 mm²	26 ... 14 AWG		
	Flexible with insulated ferrule	0.22 ... 2.5 mm²	26 ... 14 AWG		
2 conductors per clamp	Flexible with twin ferrule	0.22 ... 0.5 mm²	26 ... 20 AWG	Tool (for flexible conductor without ferrule)	Flat screwdriver Ø 3.5 mm Ø 0.138 in
Rated current / Rated cross section		20 A / 2.5 mm²	20 A / 12 AWG		
Rated short-time withstand current (1s)		300 A	396 A		
Rated voltage		630 V	300 V		
Impulse withstand voltage		6000 V			
Protection		IP20	NEMA 1		

Recommendation for best usage: in horizontal assemblies, disconnect terminal blocks should be mounted with fixed foot on top (power side) so that the disconnect knife does not partially close through gravity. Furthermore, as specified per IEC 60947-7-1, disconnect terminal blocks are intended to be used for temporary disconnection at zero potential and at no load.

The connecting capacity data for one Rigid: Solid/Stranded, or one Flexible conductor (when applicable) is a mandatory information required by IEC, UL and CSA standards (Copper conductors). All other data are provided as supplementary information only. For more details, please consult our CB, UL or CSA certificates and technical datasheet available on <http://www.TE.com>

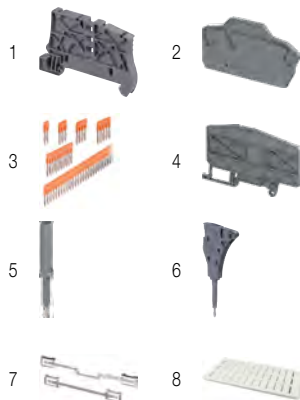
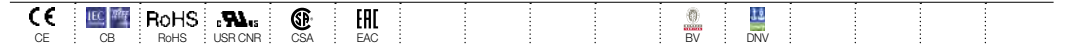

## Accessories

Description	Color	Type	Part Number	Pkg qty	Weight (1 pce) g	
1 End stops	Dark grey	BAZ1	1SNK900002R0000	50	5.30	
2 End sections	Dark grey	EK2.5-3P	1SNK705911R0000	20	2.40	
3 Jumper bars	Orange	2 poles 32 A (IEC)	JB5-2	1SNK905302R0000	50	1.30
		3 poles 32 A (IEC)	JB5-3	1SNK905303R0000	50	2.00
		4 poles 32 A (IEC)	JB5-4	1SNK905304R0000	50	2.70
		5 poles 32 A (IEC)	JB5-5	1SNK905305R0000	50	3.50
		10 poles 32 A (IEC)	JB5-10	1SNK905310R0000	30	7.10
		50 poles 32 A (IEC)	JB5-50	1SNK905350R0000	10	36.00
4 Circuit separators	Dark grey	CS-R3	1SNK900107R0000	20	6.40	
5 Test adapters	Dark grey	For test plugs DIA 2 mm 0.079 in	TP2	1SNK900203R0000	20	1.70
		For test plugs DIA 4 mm 0.157 in	TP4	1SNK900205R0000	20	2.40
6 Test connectors	Dark grey	5.2 mm 0.205 in spacing	TC5	1SNK900200R0000	10	5.20
		End module, 5.2 mm 0.205 in	TC5-R1	1SNK900201R0000	10	5.20
			SHBP	1SNK900601R0000	20	4.10
8 Terminal block markers	White	Blank marker	MG-CPM 13 41790	1960	0.23	
		Blank card	MC512	1SNK140000R0000	22	9.00
			MC512PA	1SNK149999R0000	20	10.00
		Universal wire markers holder	UMH	1SNK900611R0000	10	0.20

Complete list of accessories is indicated in the terminal block datasheet including end stops.

Some accessories such as jumper bars may modify the terminal block's ratings: Complete information available in the accessories section of the catalog.

Technical data valid for copper conductors only.

# ZK2.5-S-4P PI-Spring terminal blocks

Disconnect with blade - with test socket - 5.2 mm 0.205 in spacing



ZK2.5-S-4P

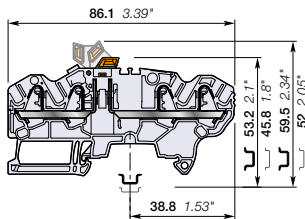

5.2 mm 0.205 in spacing

## Description

- Combine high performances with compact dimensions: 630 V IEC 300 V UL,
- Simplify the measurement with 1 built in test point DIA 2 mm 0.079 in (for current below 50mA) and TP... test adapter inserted into one jumper channel,
- Clear marking visibility with SNK top marking location 20% enlarged.

## Ordering details

Description	Color	Type	Part Number	Pkg qty	Weight (1 pce) g
Disconnect with 1 test socket DIA 2 mm 0.079 in	Grey	ZK2.5-S-4P	1SNK705312R0000	50	11.14
	Blue	ZK2.5-S-4P-BL	1SNK705321R0000	50	11.14
	Orange	ZK2.5-S-4P-OR	1SNK705331R0000	50	11.14

## Main technical data

Connecting capacity	IEC	UL - CSA	Mounting instructions
<b>1 conductor per clamp</b>	Rigid: Solid/Stranded Flexible without ferrule Flexible with non insulated ferrule Flexible with insulated ferrule	0.2 ... 4 mm <sup>2</sup> 0.22 ... 2.5 mm <sup>2</sup> 0.22 ... 2.5 mm <sup>2</sup> 0.22 ... 2.5 mm <sup>2</sup>	26 ... 12 AWG 26 ... 14 AWG 26 ... 14 AWG 26 ... 14 AWG
<b>2 conductors per clamp</b>	Flexible with twin ferrule	0.22 ... 0.5 mm <sup>2</sup>	26 ... 20 AWG
<b>Rated current / Rated cross section</b>	20 A / 2.5 mm <sup>2</sup>	20 A / 12 AWG	
<b>Rated short-time withstand current (1s)</b>	300 A		
<b>Short Circuit Current Rating (with specific conditions)</b>			
<b>Rated voltage</b>	630 V	300 V	
<b>Impulse withstand voltage</b>	6000 V		
<b>Protection</b>	IP20	NEMA 1	

Recommendation for best usage: in horizontal assemblies, disconnect terminal blocks should be mounted with fixed foot on top (power side) so that the disconnect knife does not partially close through gravity. Furthermore, as specified per IEC 60947-7-1, disconnect terminal blocks are intended to be used for temporary disconnection at zero potential and at no load.

The connecting capacity data for one Rigid: Solid/Stranded, or one Flexible conductor (when applicable) is a mandatory information required by IEC, UL and CSA standards (Copper conductors). All other data are provided as supplementary information only. For more details, please consult our CB, UL or CSA certificates and technical datasheet available on <http://www.TE.com>

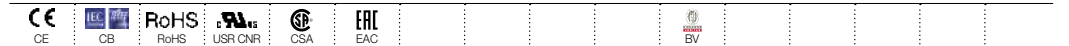

## Accessories



Description	Color	Type	Part Number	Pkg qty	Weight (1 pce) g
1 <b>End stops</b>	Dark grey	BAZ1	1SNK900002R0000	50	5.30
2 <b>End sections</b>	Dark grey	EK2.5-S-4P	1SNK705913R0000	20	2.94
3 <b>Jumper bars</b>	Orange	JB5-2	1SNK905302R0000	50	1.30
		JB5-3	1SNK905303R0000	50	2.00
		JB5-4	1SNK905304R0000	50	2.70
		JB5-5	1SNK905305R0000	50	3.50
		JB5-10	1SNK905310R0000	30	7.10
		JB5-50	1SNK905350R0000	10	36.00
4 <b>Circuit separators</b>	Dark grey	CS-R3	1SNK900107R0000	20	6.40
5 <b>Test adapters</b>	Dark grey	TP2	1SNK900203R0000	20	1.70
		TP4	1SNK900205R0000	20	2.40
6 <b>Test connectors</b>	Dark grey	TC5	1SNK900200R0000	10	5.20
		TC5-R1	1SNK900201R0000	10	5.20
7 <b>Terminal block markers</b>	White	MG-CPM 13 41790	1SNB041790R0512	1960	0.23
		MC512	1SNK140000R0000	22	9.00
		MC512PA	1SNK149999R0000	20	10.00
	Grey	UMH	1SNK900611R0000	10	0.20

Complete list of accessories is indicated in the terminal block datasheet including end stops.

Some accessories such as jumper bars may modify the terminal block's ratings: Complete information available in the accessories section of the catalog.

Technical data valid for copper conductors only.

# ZK2.5-S-R1 PI-Spring terminal blocks

## Disconnect with blade - 6 mm 0.236 in spacing



ZK2.5-S-R1

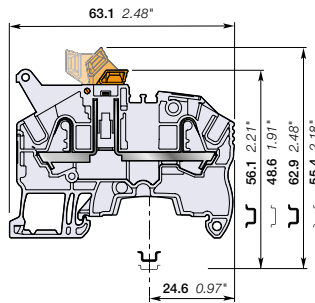

6 mm 0.236 in spacing

### Description

Simplify the distribution of circuits in marshalling cabinets thanks to our disconnect terminal blocks with the same profile as ZK2.5-SF fuse.

### Ordering details

Description	Color	Type	Part Number	Pkg qty	Weight (1 pce) g
Disconnect Profile aligned with ZK2.5-SF	Grey <input type="checkbox"/>	ZK2.5-S-R1	1SNK706310R0000	50	8.90

### Main technical data

Connecting capacity		IEC	UL - CSA	Mounting instructions	
1 conductor per clamp	Rigid: Solid/Stranded	0.2 ... 4 mm <sup>2</sup>	26 ... 12 AWG	Rail Wire stripping length	TH 35-7.5, TH 35-15 11 mm 0.433 in
	Flexible without ferrule	0.22 ... 2.5 mm <sup>2</sup>	26 ... 14 AWG		
	Flexible with non insulated ferrule	0.22 ... 2.5 mm <sup>2</sup>	26 ... 14 AWG		
	Flexible with insulated ferrule	0.22 ... 2.5 mm <sup>2</sup>	26 ... 14 AWG		
2 conductors per clamp	Flexible with twin ferrule	0.22 ... 0.5 mm <sup>2</sup>	26 ... 20 AWG	Tool (for flexible conductor without ferrule)	Flat screwdriver Ø 3.5 mm Ø 0.138 in
Rated current / Rated cross section		20 A / 2.5 mm <sup>2</sup>	20 A / 12 AWG		
Rated short-time withstand current (1s)		300 A	396 A		
Rated voltage		630 V	300 V		
Impulse withstand voltage		6000 V			
Protection		IP20	NEMA 1		

Recommendation for best usage: in horizontal assemblies, disconnect terminal blocks should be mounted with fixed foot on top (power side) so that the disconnect knife does not partially close through gravity. Furthermore, as specified per IEC 60947-7-1, disconnect terminal blocks are intended to be used for temporary disconnection at zero potential and at no load.

The connecting capacity data for one Rigid: Solid/Stranded, or one Flexible conductor (when applicable) is a mandatory information required by IEC, UL and CSA standards (Copper conductors). All other data are provided as supplementary information only. For more details, please consult our CB, UL or CSA certificates and technical datasheet available on <http://www.TE.com>



### Accessories

Description	Color	Type	Part Number	Pkg qty	Weight (1 pce) g	
1 End stops	Dark grey <input type="checkbox"/>	BAZ1	1SNK900002R0000	50	5.30	
2 End sections	Dark grey <input type="checkbox"/>	EK2.5-3P	1SNK705911R0000	20	2.40	
3 Jumper bars	Orange <input type="checkbox"/>	2 poles 41 A (IEC)	JB6-2	1SNK906302R0000	50	1.30
		3 poles 41 A (IEC)	JB6-3	1SNK906303R0000	50	2.10
		4 poles 41 A (IEC)	JB6-4	1SNK906304R0000	50	2.90
		5 poles 41 A (IEC)	JB6-5	1SNK906305R0000	50	3.60
		10 poles 41 A (IEC)	JB6-10	1SNK906310R0000	20	7.40
		50 poles 41 A (IEC)	JB6-50	1SNK906350R0000	10	38.10
4 Circuit separators	Dark grey <input type="checkbox"/>	CS-R3	1SNK900107R0000	20	6.40	
5 Test adapters	Dark grey <input type="checkbox"/>	For test plugs DIA 2 mm 0.079 in	TP2	1SNK900203R0000	20	1.70
		For test plugs DIA 4 mm 0.157 in	TP4	1SNK900205R0000	20	2.40
6 Test connectors	Dark grey <input type="checkbox"/>	TC5-R1	1SNK900201R0000	10	5.20	
7 Spacers	Dark grey <input type="checkbox"/>	ES-TC6	1SNK900105R0000	10	0.80	
		MG-CPM 13 41791	1SNB041791R0612	1680	0.27	
		MC612	1SNK150000R0000	22	10.00	
		MC612PA	1SNK159999R0000	20	11.00	
8 Terminal block markers	White <input type="checkbox"/>	Blank marker				
		Blank card				
Universal wire markers holder		Grey <input type="checkbox"/>	UMH	1SNK900611R0000	10	0.20

Complete list of accessories is indicated in the terminal block datasheet including end stops.

Some accessories such as jumper bars may modify the terminal block's ratings: Complete information available in the accessories section of the catalog.

### PI-Spring terminal blocks

Description	Color	Type	Part Number	Pkg qty	Weight (1 pce) g
Feed-through	Grey <input type="checkbox"/>	ZK4-3P	1SNK706011R0000	50	11.00
Fuse	Grey, dark grey <input type="checkbox"/>	ZK2.5-SF	1SNK706410R0000	50	16.20

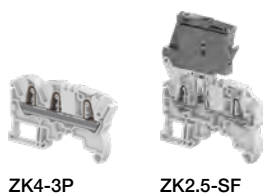

ZK4-3P

ZK2.5-SF

Technical data valid for copper conductors only.

# ZK2.5-SP PI-Spring terminal blocks

Disconnect with plug - with test sockets - 5.2 mm 0.205 in spacing

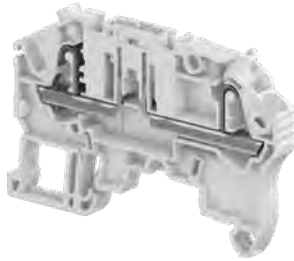

ZK2.5-SP

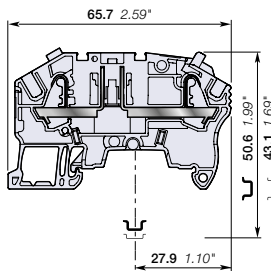

5.2 mm 0.205 in spacing

## Description

The flexible solution for fitting the component of your choice in series with our quick-fitting PG5 component holder plug:  
 – compatible with components of 8.8 x 3.2 mm 0.346 x 0.125 in, such as resistors, diodes or mini axial fuses.

## Ordering details

Description	Color	Type	Part Number	Pkg qty	Weight (1 pce) g
Disconnect with 2 test sockets DIA 2 mm 0.079 in	Grey	ZK2.5-SP	1SNK705311R0000	50	11.50

## Main technical data

Connecting capacity	IEC	UL - CSA
1 conductor per clamp	Rigid: Solid/Stranded	26 ... 12 AWG
	Flexible without ferrule	0.22 ... 2.5 mm <sup>2</sup>
	Flexible with non insulated ferrule	26 ... 14 AWG
	Flexible with insulated ferrule	26 ... 14 AWG
2 conductors per clamp	Flexible with twin ferrule	26 ... 20 AWG
Rated current / Rated cross section		17 A / 2.5 mm <sup>2</sup> 18 A / 12 AWG
Rated short-time withstand current (1s)		300 A    396 A
Rated voltage		630 V    300 V
Impulse withstand voltage		6000 V
Protection		IP20    NEMA 1

## Mounting instructions

Rail	Wire stripping length	Tool (for flexible conductor without ferrule)
TH 35-7.5, TH 35-15	11 mm 0.433 in	Flat screwdriver Ø 3.5 mm Ø 0.138 in

The connecting capacity data for one Rigid: Solid/Stranded, or one Flexible conductor (when applicable) is a mandatory information required by IEC, UL and CSA standards (Copper conductors). All other data are provided as supplementary information only. For more details, please consult our CB, UL or CSA certificates and technical datasheet available on <http://www.TE.com>

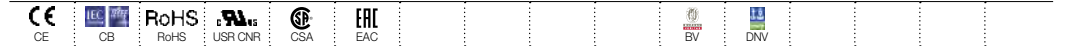

## Accessories

Description	Color	Type	Part Number	Pkg qty	Weight (1 pce) g	
1 End stops	Dark grey	BAZ1	1SNK900002R0000	50	5.30	
2 End sections	Dark grey	EK2.5-3P	1SNK705911R0000	20	2.40	
3 Jumper bars	Orange	2 poles	JB5-2	1SNK905302R0000	50	1.30
		3 poles	JB5-3	1SNK905303R0000	50	2.00
		4 poles	JB5-4	1SNK905304R0000	50	2.70
		5 poles	JB5-5	1SNK905305R0000	50	3.50
		10 poles	JB5-10	1SNK905310R0000	30	7.10
		50 poles	JB5-50	1SNK905350R0000	10	36.00
4 Circuit separators	Dark grey	CS-R3	1SNK900107R0000	20	6.40	
5 Test adapters	Dark grey	For test plugs DIA 2 mm 0.079 in	TP2	1SNK900203R0000	20	1.70
		For test plugs DIA 4 mm 0.157 in	TP4	1SNK900205R0000	20	2.40
6 Test connectors	Dark grey	5.2 mm 0.205 in spacing	TC5	1SNK900200R0000	10	5.20
		End module, 5.2 mm 0.205 in	TC5-R1	1SNK900201R0000	10	5.20
7 Shield connectors		SHBP	1SNK900601R0000	20	4.10	
8 Component plugs	Dark grey	PG5	1SNK900401R0000	20	3.50	
9 Disconnect plugs	Orange	PG5-R1	1SNK900402R0000	20	3.50	
10 Terminal block markers	White	MG-CPM 13 41790	1SNB041790R0512	1960	0.23	
		MC512	1SNK140000R0000	22	9.00	
		MC512PA	1SNK149999R0000	20	10.00	
	Grey	UMH	1SNK900611R0000	10	0.20	

Complete list of accessories is indicated in the terminal block datasheet including end stops. Some accessories such as jumper bars may modify the terminal block's ratings. Complete information available in the accessories section of the catalog.

Technical data valid for copper conductors only.



# ZK2.5-SP-4P PI-Spring terminal blocks

Disconnect with plug - with test socket - 5.2 mm 0.205 in spacing

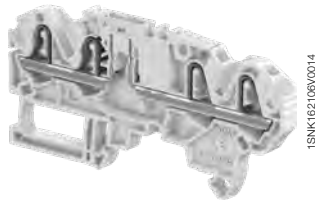

ZK2.5-SP-4P

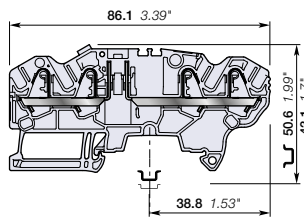

5.2 mm 0.205 in spacing

## Description

The flexible solution for fitting the component of your choice in series with our quick-fitting PG5 component holder plug:

- compatible with components of 8.8 x 3.2 mm 0.346 x 0.125 in, such as resistors, diodes or mini axial fuses.

## Ordering details

Description	Color	Type	Part Number	Pkg qty	Weight (1 pce) g
Disconnect with 1 test socket DIA 2 mm 0.079 in	Grey <input type="checkbox"/>	ZK2.5-SP-4P	1SNK705313R0000	50	10.67

## Main technical data

Connecting capacity		IEC	UL - CSA	Mounting instructions	
1 conductor per clamp	Rigid: Solid/Stranded	0.2 ... 4 mm <sup>2</sup>	26 ... 12 AWG	Rail	TH 35-7.5, TH 35-15
	Flexible without ferrule	0.22 ... 2.5 mm <sup>2</sup>	26 ... 14 AWG	Wire stripping length	11 mm 0.433 in
	Flexible with non insulated ferrule	0.22 ... 2.5 mm <sup>2</sup>	26 ... 14 AWG		
	Flexible with insulated ferrule	0.22 ... 2.5 mm <sup>2</sup>	26 ... 14 AWG		
2 conductors per clamp	Flexible with twin ferrule	0.22 ... 0.5 mm <sup>2</sup>	26 ... 20 AWG	Tool (for flexible conductor without ferrule)	Flat screwdriver Ø 3.5 mm Ø 0.138 in
Rated current / Rated cross section		17 A / 2.5 mm <sup>2</sup>	18 A / 12 AWG		
Rated short-time withstand current (1s)		300 A			
Short Circuit Current Rating (with specific conditions)					
Rated voltage		630 V	300 V		
Impulse withstand voltage		6000 V			
Protection		IP20	NEMA 1		

The connecting capacity data for one Rigid: Solid/Stranded, or one Flexible conductor (when applicable) is a mandatory information required by IEC, UL and CSA standards (Copper conductors). All other data are provided as supplementary information only. For more details, please consult our CB, UL or CSA certificates and technical datasheet available on <http://www.TE.com>

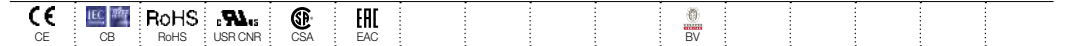

## Accessories

Description	Color	Type	Part Number	Pkg qty	Weight (1 pce) g	
1 End stops	Dark grey <input type="checkbox"/>	BAZ1	1SNK900002R0000	50	5.30	
2 End sections	Dark grey <input type="checkbox"/>	EK2.5-S-4P	1SNK705913R0000	20	2.94	
3 Jumper bars	Orange <input type="checkbox"/>	2 poles	JB5-2	1SNK905302R0000	50	1.30
		3 poles	JB5-3	1SNK905303R0000	50	2.00
		4 poles	JB5-4	1SNK905304R0000	50	2.70
		5 poles	JB5-5	1SNK905305R0000	50	3.50
		10 poles	JB5-10	1SNK905310R0000	30	7.10
		50 poles	JB5-50	1SNK905350R0000	10	36.00
4 Circuit separators	Dark grey <input type="checkbox"/>	CS-R3	1SNK900107R0000	20	6.40	
5 Test adapters	Dark grey <input type="checkbox"/>	For test plugs DIA 2 mm 0.079 in	TP2	1SNK900203R0000	20	1.70
		For test plugs DIA 4 mm 0.157 in	TP4	1SNK900205R0000	20	2.40
6 Test connectors	Dark grey <input type="checkbox"/>	5.2 mm 0.205 in spacing	TC5	1SNK900200R0000	10	5.20
		End module, 5.2 mm 0.205 in	TC5-R1	1SNK900201R0000	10	5.20
7 Component plugs	Dark grey <input type="checkbox"/>	PG5	1SNK900401R0000	20	3.50	
8 Disconnect plugs	Orange <input type="checkbox"/>	PG5-R1	1SNK900402R0000	20	3.50	
9 Terminal block markers	White <input type="checkbox"/>	Blank marker	MG-CPM 13 41790	1SNB041790R0512	1960	0.23
		Blank card	MC512	1SNK140000R0000	22	9.00
			MC512PA	1SNK149999R0000	20	10.00
		Universal wire markers holder	Grey <input type="checkbox"/>	UMH	1SNK900611R0000	10

Complete list of accessories is indicated in the terminal block datasheet including end stops.

Some accessories such as jumper bars may modify the terminal block's ratings: Complete information available in the accessories section of the catalog.

Technical data valid for copper conductors only.



# ZK2.5-SF PI-Spring terminal blocks

For 5x20 fuses - 6 mm 0.236 in spacing

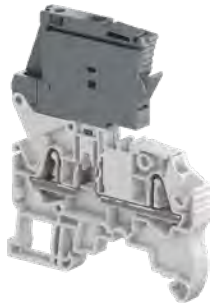

ZK2.5-SF

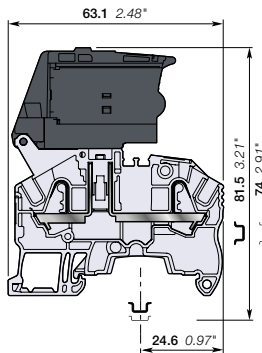

6 mm 0.236 in spacing

## Description

Protect your circuits with 5x20 fuse terminal blocks compliant with IEC 60947-7-3 standard (fuse not supplied with the terminal blocks),

- Simplify the distribution thanks to the 2 jumper channels aligned with ZK4-3P feed-through and ZK2.5-S-R1 disconnect terminal blocks.

## Ordering details

Description	Color	Type	Part Number	Pkg qty	Weight (1 pce)
Fuse	Grey, dark grey	ZK2.5-SF	1SNK706410R0000	50	16.20

## Main technical data

Connecting capacity		IEC	UL - CSA	Mounting instructions	
1 conductor per clamp	Rigid: Solid/Stranded	0.2 ... 4 mm <sup>2</sup>	26 ... 12 AWG	Rail	TH 35-7.5, TH 35-15
	Flexible without ferrule	0.22 ... 2.5 mm <sup>2</sup>		Wire stripping length	11 mm 0.433 in
	Flexible with non insulated ferrule	0.22 ... 2.5 mm <sup>2</sup>	26 ... 14 AWG		
	Flexible with insulated ferrule	0.22 ... 2.5 mm <sup>2</sup>	26 ... 14 AWG		
2 conductors per clamp	Flexible with twin ferrule	0.22 ... 0.5 mm <sup>2</sup>	26 ... 20 AWG	Tool (for flexible conductor without ferrule)	Flat screwdriver Ø 3.5 mm Ø 0.138 in
Rated current / Rated cross section		6.3 A / 2.5 mm <sup>2</sup>	16 A / 12 AWG		
Rated short-time withstand current (1s)			396 A		
Rated voltage		500 V	300 V		
Impulse withstand voltage		6000 V			
Protection		IP20	NEMA 1		

The fuse holder must be first disconnected prior any fuse replacement. Mount your fuse safely without touching any active part: put the fuse into the hooks of the fuse holder shutter; at the closing of the shutter, the fuse is perfectly in place in the fuse holder.

Separate arrangement		Assembly composed of 1 fuse terminal block in between non fuse terminal blocks	Overload and short-circuit protection	2.5 W
			Exclusive short-circuit protection	4 W
Compound arrangement		Assembly composed of 5 fuse terminal blocks	Overload and short-circuit protection	1.6 W
			Exclusive short-circuit protection	4 W

The connecting capacity data for one Rigid: Solid/Stranded, or one Flexible conductor (when applicable) is a mandatory information required by IEC, UL and CSA standards (Copper conductors). All other data are provided as supplementary information only. For more details, please consult our CB, UL or CSA certificates and technical datasheet available on <http://www.TE.com>

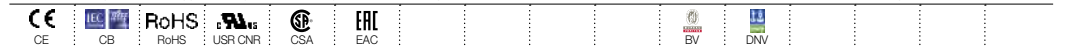

## Accessories



Description	Color	Type	Part Number	Pkg qty	Weight (1 pce)	
1 End stops	Dark grey	BAZ1	1SNK900002R0000	50	5.30	
2 End sections	Dark grey	EK2 5-3P	1SNK705911R0000	20	2.40	
3 Jumper bars	Orange	2 poles	JB6-2	1SNK906302R0000	50	1.30
		3 poles	JB6-3	1SNK906303R0000	50	2.10
		4 poles	JB6-4	1SNK906304R0000	50	2.90
		5 poles	JB6-5	1SNK906305R0000	50	3.60
		10 poles	JB6-10	1SNK906310R0000	20	7.40
		50 poles	JB6-50	1SNK906350R0000	10	38.10
4 Circuit separators	Dark grey	CS-R3	1SNK900107R0000	20	6.40	
5 Test adapters	Dark grey	For test plugs DIA 2 mm 0.079 in	TP2	1SNK900203R0000	20	1.70
		For test plugs DIA 4 mm 0.157 in	TP4	1SNK900205R0000	20	2.40
6 Test connectors	Dark grey	TC5-R1	1SNK900201R0000	10	5.20	
7 Spacers	Dark grey	ES-TC6	1SNK900105R0000	10	0.80	
			1SNK150000R0000	22	10.00	
			1SNK159999R0000	20	11.00	
8 Terminal block markers	White	MG-CPM 13 41791	1SNB041791R0612	1680	0.27	
		MC612	1SNK150000R0000	22	10.00	
		MC612PA	1SNK159999R0000	20	11.00	

Complete list of accessories is indicated in the terminal block datasheet including end stops. Some accessories such as jumper bars may modify the terminal block's ratings: Complete information available in the accessories section of the catalog.

Technical data valid for copper conductors only.

# ZK2.5-SF-R PI-Spring terminal blocks

For 5x20 fuses - with blown fuse indicator - 6 mm 0.236 in spacing

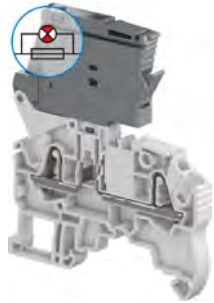

ZK2.5-SF-R

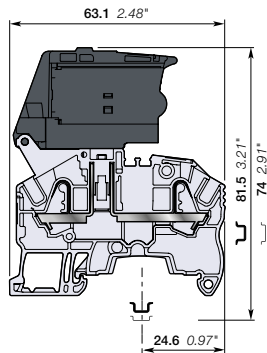

6 mm 0.236 in spacing

## Description

- Protect your circuits with 5x20 fuse terminal blocks compliant with IEC 60947-7-3 standard (fuse not supplied with the terminal blocks),
- Simplify the distribution thanks to the 2 jumper channels aligned with ZK4-3P feed-through and ZK2.5-S-R1 disconnect terminal blocks,
- Quickly identify the defective circuit thanks to the blown fuse indicator (with leakage current < 0.5 mA).

## Ordering details

Description	Color	Type	Part Number	Pkg qty	Weight (1 pce) g
Fuse with blown fuse indicator 24 ... 110 V AC / DC	Grey, dark grey	ZK2.5-SF-R1	1SNK706411R0000	50	16.30
with blown fuse indicator 115 ... 250 V AC / DC		ZK2.5-SF-R3	1SNK706412R0000	50	16.30

## Main technical data

Connecting capacity		IEC	UL - CSA	Mounting instructions	
1 conductor per clamp	Rigid: Solid/Stranded	0.2 ... 4 mm <sup>2</sup>	26 ... 12 AWG	Rail	TH 35-7.5, TH 35-15
	Flexible without ferrule	0.22 ... 2.5 mm <sup>2</sup>		Wire stripping length	11 mm 0.433 in
	Flexible with non insulated ferrule	0.22 ... 2.5 mm <sup>2</sup>	26 ... 14 AWG		
	Flexible with insulated ferrule	0.22 ... 2.5 mm <sup>2</sup>	26 ... 14 AWG		
2 conductors per clamp	Flexible with twin ferrule	0.22 ... 0.5 mm <sup>2</sup>	26 ... 20 AWG	Tool (for flexible conductor without ferrule)	Flat screwdriver Ø 3.5 mm Ø 0.138 in
Rated current / Rated cross section		6.3 A / 2.5 mm <sup>2</sup>	16 A / 12 AWG		
Rated short-time withstand current (1s)			396 A		
Rated voltage		500 V	300 V		
Impulse withstand voltage		6000 V			
Protection		IP20	NEMA 1		

The fuse holder must be first disconnected prior any fuse replacement. Mount your fuse safely without touching any active part: put the fuse into the hooks of the fuse holder shutter; at the closing of the shutter, the fuse is perfectly in place in the fuse holder.

Separate arrangement		Assembly composed of 1 fuse terminal block in between non fuse terminal blocks	Overload and short-circuit protection	2.5 W
			Exclusive short-circuit protection	4 W
Compound arrangement		Assembly composed of 5 fuse terminal blocks	Overload and short-circuit protection	1.6 W
			Exclusive short-circuit protection	4 W

The connecting capacity data for one Rigid: Solid/Stranded, or one Flexible conductor (when applicable) is a mandatory information required by IEC, UL and CSA standards (Copper conductors). All other data are provided as supplementary information only. For more details, please consult our CB, UL or CSA certificates and technical datasheet available on <http://www.TE.com>

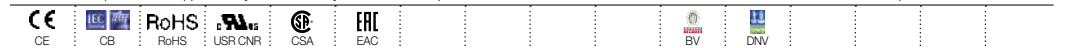

## Accessories

Description	Color	Type	Part Number	Pkg qty	Weight (1 pce) g	
1 End stops	Dark grey	BAZ1	1SNK900002R0000	50	5.30	
2 End sections	Dark grey	EK2.5-3P	1SNK705911R0000	20	2.40	
3 Jumper bars	Orange	2 poles	JB6-2	1SNK906302R0000	50	1.30
		3 poles	JB6-3	1SNK906303R0000	50	2.10
		4 poles	JB6-4	1SNK906304R0000	50	2.90
		5 poles	JB6-5	1SNK906305R0000	50	3.60
		10 poles	JB6-10	1SNK906310R0000	20	7.40
		50 poles	JB6-50	1SNK906350R0000	10	38.10
4 Circuit separators	Dark grey	CS-R3	1SNK900107R0000	20	6.40	
5 Test adapters	Dark grey	TP2	1SNK900203R0000	20	1.70	
		TP4	1SNK900205R0000	20	2.40	
6 Test connectors	Dark grey	TC5-R1	1SNK900201R0000	10	5.20	
7 Spacers	Dark grey	ES-TC6	1SNK900105R0000	10	0.80	
	White	MG-CPM 13 41791	1SNB041791R0612	1680	0.27	
		MC612	1SNK150000R0000	22	10.00	
8 Terminal block markers		MC612PA	1SNK159999R0000	20	11.00	

Complete list of accessories is indicated in the terminal block datasheet including end stops.

Some accessories such as jumper bars may modify the terminal block's ratings: Complete information available in the accessories section of the catalog.

Technical data valid for copper conductors only.

# ZK2.5-D2 PI-Spring terminal blocks

Double deck with 2 feed-through circuits - 5.2 mm 0.205 in spacing



ZK2.5-D2

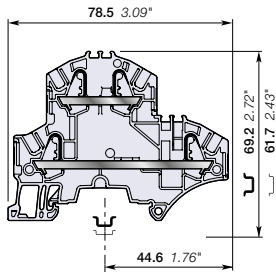

5.2 mm 0.205 in spacing

## Description

Combine high performance with compact dimensions:

- 800 V IEC 600 V UL,
- 2 jumper channels and a large input and output marker zone on each deck.

## Ordering details

Description	Color	Type	Part Number	Pkg qty	Weight (1 pce) g
Feed-through 2 feed-through circuits	Grey <input type="checkbox"/>	ZK2.5-D2	1SNK705210R0000	50	11.20
	Blue <input type="checkbox"/>	ZK2.5-D2-BL	1SNK705220R0000	50	11.20

## Main technical data

Connecting capacity	IEC	UL - CSA	Mounting instructions
1 conductor per clamp	Rigid: Solid/Stranded	0.2 ... 4 mm <sup>2</sup>	26 ... 12 AWG
	Flexible without ferrule	0.22 ... 2.5 mm <sup>2</sup>	26 ... 14 AWG
	Flexible with non insulated ferrule	0.22 ... 2.5 mm <sup>2</sup>	26 ... 14 AWG
	Flexible with insulated ferrule	0.22 ... 2.5 mm <sup>2</sup>	26 ... 14 AWG
2 conductors per clamp	Flexible with twin ferrule	0.22 ... 0.5 mm <sup>2</sup>	26 ... 20 AWG
Rated current / Rated cross section		24 A / 2.5 mm <sup>2</sup>	20 A / 12 AWG
Rated short-time withstand current (1s)		300 A	396 A
Short Circuit Current Rating (with specific conditions)			100 kA
Rated voltage		800 V	600 V
Impulse withstand voltage		8000 V	
Protection		IP20	NEMA 1
Increased safety Ex e		693 V 21 A IEC/EN 60079-7 - IM2 II 2 GD Ex eb I/IC/IIIC	

The connecting capacity data for one Rigid: Solid/Stranded, or one Flexible conductor (when applicable) is a mandatory information required by IEC, UL and CSA standards (Copper conductors). All other data are provided as supplementary information only. For more details, please consult our CB, UL or CSA certificates and technical datasheet available on <http://www.TE.com>



## Accessories

Description	Color	Type	Part Number	Pkg qty	Weight (1 pce) g	
1 End stops 10 mm 0.394 in	Dark grey <input type="checkbox"/>	BAZH1	1SNK900102R0000	20	24.00	
2 End sections 2 mm 0.079 in	Dark grey <input type="checkbox"/>	EK2.5-D2	1SNK705960R0000	20	3.40	
3 Jumper bars	Orange <input type="checkbox"/>	2 poles 32 A (IEC)	JB5-2	1SNK905302R0000	50	1.30
		3 poles 32 A (IEC)	JB5-3	1SNK905303R0000	50	2.00
		4 poles 32 A (IEC)	JB5-4	1SNK905304R0000	50	2.70
		5 poles 32 A (IEC)	JB5-5	1SNK905305R0000	50	3.50
		10 poles 32 A (IEC)	JB5-10	1SNK905310R0000	30	7.10
		50 poles 32 A (IEC)	JB5-50	1SNK905350R0000	10	36.00
4 Test adapters	Dark grey <input type="checkbox"/>	For test plugs DIA 2 mm 0.079 in	TP2	1SNK900203R0000	20	1.70
		For test plugs DIA 4 mm 0.157 in	TP4	1SNK900205R0000	20	2.40
5 Test connectors 5.2 mm 0.205 in spacing	Dark grey <input type="checkbox"/>	End module, 5.2 mm 0.205 in	TC5	1SNK900200R0000	10	5.20
			TC5-R1	1SNK900201R0000	10	5.20
6 Shield connectors		SHB	1SNK900602R0000	20	4.90	
7 Label holders	Dark grey <input type="checkbox"/>	LH-J	1SNK900606R0000	100	0.73	
8 Terminal block markers	White <input type="checkbox"/>	Blank marker	MG-CPM 13 41790	1SNB041790R0512	1960	0.23
		Blank card	MC512	1SNK140000R0000	22	9.00
			MC512PA	1SNK149999R0000	20	10.00
		Universal wire markers holder	Grey <input type="checkbox"/>	UMH	1SNK900611R0000	10

Complete list of accessories is indicated in the terminal block datasheet including end stops. Some accessories such as jumper bars may modify the terminal block's ratings: Complete information available in the accessories section of the catalog.



## Ground PI-Spring terminal blocks

Description	Color	Type	Part Number	Pkg qty	Weight (1 pce) g
Ground Profile aligned with ZK2.5-D2 and ZK2.5-D1	Green-yellow <input type="checkbox"/>	ZK2.5-D1-PE	1SNK705250R0000	20	15.70

Technical data valid for copper conductors only.

# ZK2.5-D1 PI-Spring terminal blocks

Double deck with 1 feed-through circuit - 5.2 mm 0.205 in spacing



1SNK162078V0014

ZK2.5-D1

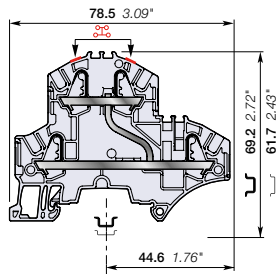

5.2 mm 0.205 in spacing

## Description

– Find the same functionalities as ZK2.5-D2 and ease one potential distribution on 4 independent connections.

## Ordering details

Description	Color	Type	Part Number	Pkg qty	Weight (1 pce) g
Feed-through 1 feed-through circuit	Grey <input type="checkbox"/>	ZK2.5-D1	1SNK705211R0000	50	11.20

## Main technical data

Connecting capacity		IEC	UL - CSA	Mounting instructions	
1 conductor per clamp	Rigid: Solid/Stranded	0.2 ... 4 mm <sup>2</sup>	26 ... 12 AWG	Rail	TH 35-7.5, TH 35-15
	Flexible without ferrule	0.22 ... 2.5 mm <sup>2</sup>		Wire stripping length	11 mm 0.433 in
	Flexible with non insulated ferrule	0.22 ... 2.5 mm <sup>2</sup>	26 ... 14 AWG	Tool (for flexible conductor without ferrule)	Flat screwdriver Ø 3.5 mm Ø 0.138 in
	Flexible with insulated ferrule	0.22 ... 2.5 mm <sup>2</sup>	26 ... 14 AWG		
2 conductors per clamp	Flexible with twin ferrule	0.22 ... 0.5 mm <sup>2</sup>	26 ... 20 AWG		
Rated current / Rated cross section		24 A / 2.5 mm <sup>2</sup>	20 A / 12 AWG		
Rated short-time withstand current (1s)		300 A	396 A		
Short Circuit Current Rating (with specific conditions)			100 kA		
Rated voltage		800 V	600 V		
Impulse withstand voltage		8000 V			
Protection		IP20	NEMA 1		
Increased safety Ex e		693 V 21 A IEC/EN 60079-7 - IM2 II 2 GD Ex eb I/II/C			

The connecting capacity data for one Rigid: Solid/Stranded, or one Flexible conductor (when applicable) is a mandatory information required by IEC, UL and CSA standards (Copper conductors). All other data are provided as supplementary information only. For more details, please consult our CB, UL or CSA certificates and technical datasheet available on <http://www.TE.com>

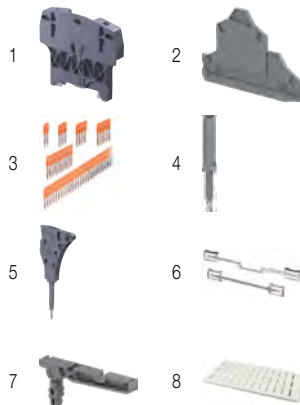

## Accessories

Description	Color	Type	Part Number	Pkg qty	Weight (1 pce) g	
1 End stops 10 mm 0.394 in	Dark grey <input type="checkbox"/>	BAZH1	1SNK900102R0000	20	24.00	
2 End sections 2 mm 0.079 in	Dark grey <input type="checkbox"/>	EK2.5-D2	1SNK705960R0000	20	3.40	
3 Jumper bars	Orange <input type="checkbox"/>	2 poles 32 A (IEC)	JB5-2	1SNK905302R0000	50	1.30
		3 poles 32 A (IEC)	JB5-3	1SNK905303R0000	50	2.00
		4 poles 32 A (IEC)	JB5-4	1SNK905304R0000	50	2.70
		5 poles 32 A (IEC)	JB5-5	1SNK905305R0000	50	3.50
		10 poles 32 A (IEC)	JB5-10	1SNK905310R0000	30	7.10
		50 poles 32 A (IEC)	JB5-50	1SNK905350R0000	10	36.00
4 Test adapters	Dark grey <input type="checkbox"/>	For test plugs DIA 2 mm 0.079 in	TP2	1SNK900203R0000	20	1.70
		For test plugs DIA 4 mm 0.157 in	TP4	1SNK900205R0000	20	2.40
5 Test connectors	Dark grey <input type="checkbox"/>	5.2 mm 0.205 in spacing	TC5	1SNK900200R0000	10	5.20
		End module, 5.2 mm 0.205 in	TC5-R1	1SNK900201R0000	10	5.20
6 Shield connectors		SHB	1SNK900602R0000	20	4.90	
7 Label holders	Dark grey <input type="checkbox"/>	LH-J	1SNK900606R0000	100	0.73	
8 Terminal block markers	White <input type="checkbox"/>	Blank marker	MG-CPM 13 41790	1SNB041790R0512	1960	0.23
		Blank card	MC512	1SNK140000R0000	22	9.00
			MC512PA	1SNK149999R0000	20	10.00
	Universal wire markers holder	Grey <input type="checkbox"/>	UMH	1SNK900611R0000	10	0.20

Complete list of accessories is indicated in the terminal block datasheet including end stops. Some accessories such as jumper bars may modify the terminal block's ratings: Complete information available in the accessories section of the catalog.



## Ground PI-Spring terminal blocks

Description	Color	Type	Part Number	Pkg qty	Weight (1 pce) g
Ground Profile aligned with ZK2.5-D2 and ZK2.5-D1	Green-yellow <input type="checkbox"/>	ZK2.5-D1-PE	1SNK705250R0000	20	15.70

Technical data valid for copper conductors only.



# ZK2.5-D2-PE PI-Spring terminal blocks

Double deck with 1 feed-through circuit and 1 ground circuit - 5.2 mm 0.205 in spacing



1SNK162079R0014

ZK2.5-D2-PE

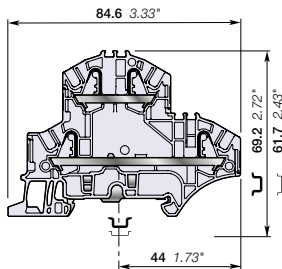

5.2 mm 0.205 in spacing

## Description

Combine high performance with compact dimensions:

- 800 V IEC 600 V UL,
- 1 feed through circuit and 1 ground circuit in just 5.2 mm 0.205 in spacing,
- 2 jumper channels and a large input and output marker zone on each deck,
- designed for easy wiring.

## Ordering details

Description	Color	Type	Part Number	Pkg qty	Weight (1 pce)
Feed-through + ground	Grey, Green-yellow	ZK2.5-D2-PE	1SNK705212R0000	20	15.70

## Main technical data

Connecting capacity		IEC	UL - CSA	Mounting instructions	
1 conductor per clamp	Rigid: Solid/Stranded	0.2 ... 4 mm <sup>2</sup>	26 ... 12 AWG	Rail	TH 35-7.5, TH 35-15
	Flexible without ferrule	0.22 ... 2.5 mm <sup>2</sup>	26 ... 12 AWG	Wire stripping length	11 mm 0.433 in
	Flexible with non insulated ferrule	0.22 ... 2.5 mm <sup>2</sup>	26 ... 14 AWG		
	Flexible with insulated ferrule	0.22 ... 2.5 mm <sup>2</sup>	26 ... 14 AWG		
2 conductors per clamp	Flexible with twin ferrule	0.22 ... 0.5 mm <sup>2</sup>	26 ... 20 AWG	Tool (for flexible conductor without ferrule)	Flat screwdriver Ø 3.5 mm Ø 0.138 in
Rated current / Rated cross section		24 A / 2.5 mm <sup>2</sup>	20 A / 12 AWG		
Rated short-time withstand current (1s)		300 A	396 A		
Short Circuit Current Rating (with specific conditions)					
Rated voltage		800 V	600 V		
Impulse withstand voltage		8000 V			
Protection		IP20	NEMA 1		
Increased safety Ex e		693 V 21 A IEC/EN 60079-7 - IM2 II 2 GD Ex eb I/IC/IIIC			

The connecting capacity data for one Rigid: Solid/Stranded, or one Flexible conductor (when applicable) is a mandatory information required by IEC, UL and CSA standards (Copper conductors). All other data are provided as supplementary information only. For more details, please consult our CB, UL or CSA certificates and technical datasheet available on <http://www.TE.com>



## Accessories

Description	Color	Type	Part Number	Pkg qty	Weight (1 pce)	
1 End stops	Dark grey	BAZH1	1SNK900102R0000	20	24.00	
2 End sections	Dark grey	EK2.5-D2	1SNK705960R0000	20	3.40	
3 Jumper bars	Orange	2 poles 32 A (IEC)	JB5-2	1SNK905302R0000	50	1.30
		3 poles 32 A (IEC)	JB5-3	1SNK905303R0000	50	2.00
		4 poles 32 A (IEC)	JB5-4	1SNK905304R0000	50	2.70
		5 poles 32 A (IEC)	JB5-5	1SNK905305R0000	50	3.50
		10 poles 32 A (IEC)	JB5-10	1SNK905310R0000	30	7.10
4 Test adapters	Dark grey	For test plugs DIA 2 mm 0.079 in	TP2	1SNK900203R0000	20	1.70
		For test plugs DIA 4 mm 0.157 in	TP4	1SNK900205R0000	20	2.40
5 Test connectors	Dark grey	5.2 mm 0.205 in spacing	TC5	1SNK900200R0000	10	5.20
		End module, 5.2 mm 0.205 in	TC5-R1	1SNK900201R0000	10	5.20
6 Shield connectors		SHB	1SNK900602R0000	20	4.90	
7 Label holders	Dark grey	LH-J	1SNK900606R0000	100	0.73	
8 Terminal block markers	White	Blank marker	MG-CPM 13 41790	1SNB041790R0512	1960	0.23
		Blank card	MC512	1SNK140000R0000	22	9.00
			MC512PA	1SNK149999R0000	20	10.00
	Universal wire markers holder	Grey	UMH	1SNK900611R0000	10	0.20

Complete list of accessories is indicated in the terminal block datasheet including end stops. Some accessories such as jumper bars may modify the terminal block's ratings: Complete information available in the accessories section of the catalog.

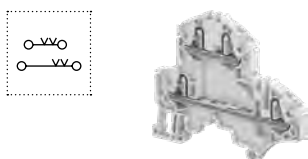

## Feed-through PI-Spring terminal blocks

Description	Color	Type	Part Number	Pkg qty	Weight (1 pce)
Feed-through	Grey	ZK2.5-D2	1SNK705210R0000	50	11.20

Technical data valid for copper conductors only.



# ZK2.5-D1-PE PI-Spring terminal blocks

Double deck with 1 ground circuit - 5.2 mm 0.205 in spacing

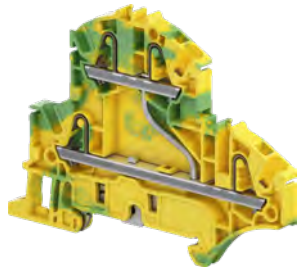

1SNK162049S0201

ZK2.5-D1-PE

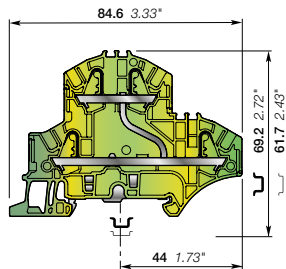

5.2 mm 0.205 in spacing

## Description

Improve the safety of your installation in the event of a short-circuit thanks to our screwless rail contact:

- Rail contact non operator dependent,
- Performances above the requirements of the IEC 60947-7-2 terminal block standard,
- Secured snap on or off the rail,
- Profile aligned with ZK2.5-D2.

## Ordering details

Description	Color	Type	Part Number	Pkg qty	Weight (1 pce) g
Ground 1 ground circuit	Green-yellow	ZK2.5-D1-PE	1SNK705250R0000	20	15.70

## Main technical data

Connecting capacity		IEC	UL - CSA	Mounting instructions	
1 conductor per clamp	Rigid: Solid/Stranded	0.2 ... 4 mm <sup>2</sup>	26 ... 12 AWG	Rail	TH 35-7.5, TH 35-15
	Flexible without ferrule	0.22 ... 2.5 mm <sup>2</sup>		Wire stripping length	11 mm 0.433 in
	Flexible with non insulated ferrule	0.22 ... 2.5 mm <sup>2</sup>	26 ... 14 AWG		
	Flexible with insulated ferrule	0.22 ... 2.5 mm <sup>2</sup>	26 ... 14 AWG		
Rated cross section		2.5 mm <sup>2</sup>	12 AWG	Tool (for flexible conductor without ferrule)	Flat screwdriver Ø 3.5 mm Ø 0.138 in
Rated short-time withstand current (1s)		300 A	396 A		
Protection		IP20	NEMA 1		
Explosive atmosphere classification		IM2 II 2 GD Ex eb I/IC/IIIC - Class I, Zone 1, AEx e II, Ex e II U			

The connecting capacity data for one Rigid: Solid/Stranded, or one Flexible conductor (when applicable) is a mandatory information required by IEC, UL and CSA standards (Copper conductors). All other data are provided as supplementary information only. For more details, please consult our CB, UL or CSA certificates and technical datasheet available on <http://www.TE.com>



## Accessories

Description	Color	Type	Part Number	Pkg qty	Weight (1 pce) g
1 End stops 10 mm 0.394 in	Dark grey	BAZH1	1SNK900102R0000	20	24.00
2 End sections 2 mm 0.079 in	Dark grey	EK2.5-D2	1SNK705960R0000	20	3.40
3 Test adapters For test plugs DIA 2 mm 0.079 in For test plugs DIA 4 mm 0.157 in	Dark grey	TP2	1SNK900203R0000	20	1.70
		TP4	1SNK900205R0000	20	2.40
4 Test connectors 5.2 mm 0.205 in spacing End module, 5.2 mm 0.205 in	Dark grey	TC5	1SNK900200R0000	10	5.20
		TC5-R1	1SNK900201R0000	10	5.20
5 Shield connectors		SHB	1SNK900602R0000	20	4.90
6 Label holders	Dark grey	LH-J	1SNK900606R0000	100	0.73
7 Terminal block markers Blank marker Blank card Universal wire markers holder	White	MG-CPM 13 41790	1SNB041790R0512	1960	0.23
		MC512	1SNK140000R0000	22	9.00
		MC512PA	1SNK149999R0000	20	10.00
	Grey	UMH	1SNK900611R0000	10	0.20

Complete list of accessories is indicated in the terminal block datasheet including end stops. Some accessories such as jumper bars may modify the terminal block's ratings: Complete information available in the accessories section of the catalog.

Technical data valid for copper conductors only.

# ZK2.5-T3 PI-Spring terminal blocks

Triple deck with 3 feed-through circuits - 5.2 mm 0.205 in spacing



ZK2.5-T3

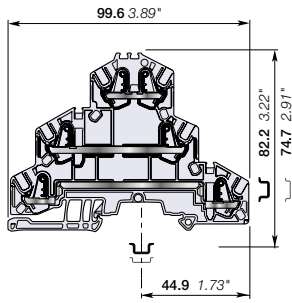

5.2 mm 0.205 in spacing

## Description

Combine high performance with compact dimensions in just 5.2 mm 0.205 in spacing:  
 - 500 V IEC 300 V UL,  
 - 1 jumper channel and a large input and output marker zone on each deck.

## Ordering details

Description	Color	Type	Part Number	Pkg qty	Weight (1 pce) g
Feed-through 3 feed-through circuits	Grey <input type="checkbox"/>	ZK2.5-T3	1SNK705510R0000	25	17.33

## Main technical data

Connecting capacity		IEC	UL - CSA	Mounting instructions	
1 conductor per clamp	Rigid: Solid/Stranded	0.2 ... 4 mm <sup>2</sup>	26 ... 12 AWG	Rail	TH 35-7.5, TH 35-15
	Flexible without ferrule	0.22 ... 2.5 mm <sup>2</sup>		Wire stripping length	11 mm 0.433 in
	Flexible with non insulated ferrule	0.22 ... 2.5 mm <sup>2</sup>	26 ... 14 AWG	Tool (for flexible conductor without ferrule)	Flat screwdriver Ø 3.5 mm Ø 0.138 in
	Flexible with insulated ferrule	0.22 ... 2.5 mm <sup>2</sup>	26 ... 14 AWG		
2 conductors per clamp	Flexible with twin ferrule	0.22 ... 0.5 mm <sup>2</sup>	26 ... 20 AWG		
Rated current / Rated cross section		22 A / 2.5 mm <sup>2</sup>	20 A / 12 AWG		
Rated short-time withstand current (1s)		300 A			
Short Circuit Current Rating (with specific conditions)					
Rated voltage		500 V	300 V		
Impulse withstand voltage		8000 V			
Protection		IP20	NEMA 1		
Increased safety Ex e		440 V 20 A IEC/EN 60079-7 - IM2 II 2 GD Ex eb IIC/IIC			

The connecting capacity data for one Rigid: Solid/Stranded, or one Flexible conductor (when applicable) is a mandatory information required by IEC, UL and CSA standards (Copper conductors). All other data are provided as supplementary information only. For more details, please consult our CB, UL or CSA certificates and technical datasheet available on <http://www.TE.com>



## Accessories

Description	Color	Type	Part Number	Pkg qty	Weight (1 pce) g	
1 End stops 10 mm 0.394 in	Dark grey <input type="checkbox"/>	BAZH1	1SNK900102R0000	20	24.00	
2 End sections 0.8 mm 0.031 in	Dark grey <input type="checkbox"/>	EK2.5-T3	1SNK705961R0000	20	4.76	
3 Jumper bars	Orange <input type="checkbox"/>	2 poles 32 A (IEC)	JB5-2	1SNK905302R0000	50	1.30
		3 poles 32 A (IEC)	JB5-3	1SNK905303R0000	50	2.00
		4 poles 32 A (IEC)	JB5-4	1SNK905304R0000	50	2.70
		5 poles 32 A (IEC)	JB5-5	1SNK905305R0000	50	3.50
		10 poles 32 A (IEC)	JB5-10	1SNK905310R0000	30	7.10
		50 poles 32 A (IEC)	JB5-50	1SNK905350R0000	10	36.00
4 Test adapters	Dark grey <input type="checkbox"/>	For test plugs DIA 2 mm 0.079 in	TP2	1SNK900203R0000	20	1.70
		For test plugs DIA 4 mm 0.157 in	TP4	1SNK900205R0000	20	2.40
5 Test connectors	Dark grey <input type="checkbox"/>	5.2 mm 0.205 in spacing	TC5	1SNK900200R0000	10	5.20
		End module, 5.2 mm 0.205 in	TC5-R1	1SNK900201R0000	10	5.20
6 Label holders	Dark grey <input type="checkbox"/>		LH-J	1SNK900606R0000	100	0.73
		Blank marker	MG-CPM 13 41790	1SNB041790R0512	1960	0.23
7 Terminal block markers	White <input type="checkbox"/>	Blank card	MC512	1SNK140000R0000	22	9.00
			MC512PA	1SNK149999R0000	20	10.00
		Universal wire markers holder	Grey <input type="checkbox"/>	UMH	1SNK900611R0000	10

Complete list of accessories is indicated in the terminal block datasheet including end stops.  
 Some accessories such as jumper bars may modify the terminal block's ratings: Complete information available in the accessories section of the catalog.



## Ground PI-Spring terminal blocks

Description	Color	Type	Part Number	Pkg qty	Weight (1 pce) g
Ground	Green-yellow <input type="checkbox"/>	ZK2.5-T1-PE	1SNK705550R0000	25	21.53

Technical data valid for copper conductors only.

# ZK2.5-T1 PI-Spring terminal blocks

Triple deck with 1 feed-through circuit - 5.2 mm 0.205 in spacing



ZK2.5-T1

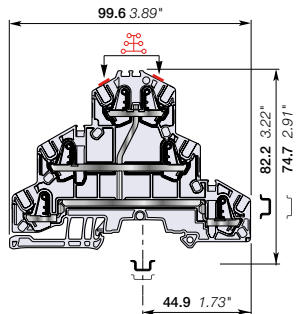

5.2 mm 0.205 in spacing

## Description

Find the same functionalities as ZK2.5-T3 and ease one potential distribution on 6 independent connections.

## Ordering details

Description	Color	Type	Part Number	Pkg qty	Weight (1 pce) g
Feed-through 1 feed-through circuit	Grey <input type="checkbox"/>	ZK2.5-T1	1SNK705511R0000	25	17.33

## Main technical data

Connecting capacity		IEC	UL - CSA	Mounting instructions	
1 conductor per clamp	Rigid: Solid/Stranded	0.2 ... 4 mm <sup>2</sup>	26 ... 12 AWG	Rail	TH 35-7.5, TH 35-15
	Flexible without ferrule	0.22 ... 2.5 mm <sup>2</sup>	26 ... 14 AWG	Wire stripping length	11 mm 0.433 in
	Flexible with non insulated ferrule	0.22 ... 2.5 mm <sup>2</sup>	26 ... 14 AWG	Tool (for flexible conductor without ferrule)	Flat screwdriver Ø 3.5 mm Ø 0.138 in
	Flexible with insulated ferrule	0.22 ... 2.5 mm <sup>2</sup>	26 ... 14 AWG		
2 conductors per clamp	Flexible with twin ferrule	0.22 ... 0.5 mm <sup>2</sup>	26 ... 20 AWG		
Rated current / Rated cross section		22 A / 2.5 mm <sup>2</sup>	20 A / 12 AWG		
Rated short-time withstand current (1s)		300 A			
Short Circuit Current Rating (with specific conditions)					
Rated voltage		500 V	300 V		
Impulse withstand voltage		8000 V			
Protection		IP20	NEMA 1		
Increased safety Ex e		440 V 20 A IEC/EN 60079-7 - IM2 II 2 GD Ex eb I/IC/IIIC			

The connecting capacity data for one Rigid: Solid/Stranded, or one Flexible conductor (when applicable) is a mandatory information required by IEC, UL and CSA standards (Copper conductors). All other data are provided as supplementary information only. For more details, please consult our CB, UL or CSA certificates and technical datasheet available on <http://www.TE.com>

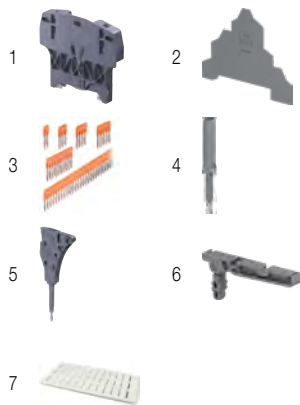

## Accessories

Description	Color	Type	Part Number	Pkg qty	Weight (1 pce) g	
1 End stops	Dark grey <input type="checkbox"/>	BAZH1	1SNK900102R0000	20	24.00	
2 End sections	Dark grey <input type="checkbox"/>	EK2.5-T3	1SNK705961R0000	20	4.76	
3 Jumper bars	Orange <input type="checkbox"/>	2 poles	JB5-2	1SNK905302R0000	50	1.30
		3 poles	JB5-3	1SNK905303R0000	50	2.00
		4 poles	JB5-4	1SNK905304R0000	50	2.70
		5 poles	JB5-5	1SNK905305R0000	50	3.50
		10 poles	JB5-10	1SNK905310R0000	30	7.10
		50 poles	JB5-50	1SNK905350R0000	10	36.00
4 Test adapters	Dark grey <input type="checkbox"/>	For test plugs DIA 2 mm 0.079 in	TP2	1SNK900203R0000	20	1.70
		For test plugs DIA 4 mm 0.157 in	TP4	1SNK900205R0000	20	2.40
5 Test connectors	Dark grey <input type="checkbox"/>	5.2 mm 0.205 in spacing	TC5	1SNK900200R0000	10	5.20
		End module, 5.2 mm 0.205 in	TC5-R1	1SNK900201R0000	10	5.20
6 Label holders	Dark grey <input type="checkbox"/>	LH-J	1SNK900606R0000	100	0.73	
7 Terminal block markers	White <input type="checkbox"/>	Blank marker	MG-CPM 13 41790	1SNB041790R0512	1960	0.23
		Blank card	MC512	1SNK140000R0000	22	9.00
			MC512PA	1SNK149999R0000	20	10.00
		Universal wire markers holder	Grey <input type="checkbox"/>	UMH	1SNK900611R0000	10

Complete list of accessories is indicated in the terminal block datasheet including end stops. Some accessories such as jumper bars may modify the terminal block's ratings. Complete information available in the accessories section of the catalog.

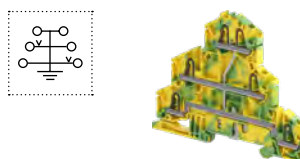

## Ground PI-Spring terminal blocks

Description	Color	Type	Part Number	Pkg qty	Weight (1 pce) g
Ground	Green-yellow <input type="checkbox"/>	ZK2.5-T1-PE	1SNK705550R0000	25	21.53

Technical data valid for copper conductors only.

# ZK2.5-L-L-PE PI-Spring terminal blocks

Triple deck with 2 feed-through circuits and 1 ground circuit - 5.2 mm 0.205 in spacing



1SNK162112R0014

ZK2.5-L-L-PE

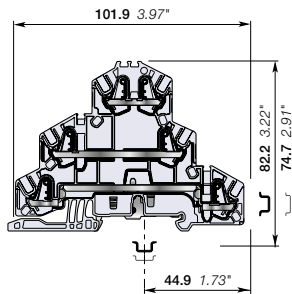

5.2 mm 0.205 in spacing

## Description

Combine high performance with compact dimensions:

- 500V IEC 300 V UL,
- 2 feed through circuits and 1 ground circuit in just 5.2 mm 0.205 in spacing,
- 1 jumper channel and a large input and output marker zone on each deck,
- designed for easy wiring.

## Ordering details

Description	Color	Type	Part Number	Pkg qty	Weight (1 pce)
Feed-through + ground	Grey, Green-yellow	ZK2.5-L-L-PE	1SNK705512R0000	25	21.38

## Main technical data

Connecting capacity		IEC	UL - CSA	Mounting instructions	
1 conductor per clamp	Rigid: Solid/Stranded	0.2 ... 4 mm <sup>2</sup>	26 ... 12 AWG	Rail	TH 35-7.5, TH 35-15
	Flexible without ferrule	0.22 ... 2.5 mm <sup>2</sup>	26 ... 12 AWG	Wire stripping length	11 mm 0.433 in
	Flexible with non insulated ferrule	0.22 ... 2.5 mm <sup>2</sup>	26 ... 14 AWG		
	Flexible with insulated ferrule	0.22 ... 2.5 mm <sup>2</sup>	26 ... 14 AWG		
2 conductors per clamp	Flexible with twin ferrule	0.22 ... 0.5 mm <sup>2</sup>	26 ... 20 AWG	Tool (for flexible conductor without ferrule)	Flat screwdriver Ø 3.5 mm Ø 0.138 in
Rated current / Rated cross section		22 A / 2.5 mm <sup>2</sup>	20 A / 12 AWG		
Rated short-time withstand current (1s)		300 A	396 A		
Short Circuit Current Rating (with specific conditions)					
Rated voltage		500 V	300 V		
Impulse withstand voltage		8000 V			
Protection		IP20	NEMA 1		
Increased safety Ex e		440 V 20 A IEC/EN 60079-7 - IM2 II 2 GD Ex eb I/IC/IIIC			

The connecting capacity data for one Rigid: Solid/Stranded, or one Flexible conductor (when applicable) is a mandatory information required by IEC, UL and CSA standards (Copper conductors). All other data are provided as supplementary information only. For more details, please consult our CB, UL or CSA certificates and technical datasheet available on <http://www.TE.com>



## Accessories

Description	Color	Type	Part Number	Pkg qty	Weight (1 pce)	
1 End stops	Dark grey	BAZH1	1SNK900102R0000	20	24.00	
2 End sections	Dark grey	EK2.5-T3	1SNK705961R0000	20	4.76	
3 Jumper bars	Orange	2 poles 32 A (IEC)	JB5-2	1SNK905302R0000	50	1.30
		3 poles 32 A (IEC)	JB5-3	1SNK905303R0000	50	2.00
		4 poles 32 A (IEC)	JB5-4	1SNK905304R0000	50	2.70
		5 poles 32 A (IEC)	JB5-5	1SNK905305R0000	50	3.50
		10 poles 32 A (IEC)	JB5-10	1SNK905310R0000	30	7.10
4 Test adapters	Dark grey	For test plugs DIA 2 mm 0.079 in	TP2	1SNK900203R0000	20	1.70
		For test plugs DIA 4 mm 0.157 in	TP4	1SNK900205R0000	20	2.40
5 Test connectors	Dark grey	5.2 mm 0.205 in spacing	TC5	1SNK900200R0000	10	5.20
		End module, 5.2 mm 0.205 in	TC5-R1	1SNK900201R0000	10	5.20
6 Label holders	Dark grey		LH-J	1SNK900606R0000	100	0.73
7 Terminal block markers	White	Blank marker	MG-CPM 13 41790	1SNB041790R0512	1960	0.23
		Blank card	MC512	1SNK140000R0000	22	9.00
			MC512PA	1SNK149999R0000	20	10.00
	Grey	Universal wire markers holder	UMH	1SNK900611R0000	10	0.20

Complete list of accessories is indicated in the terminal block datasheet including end stops. Some accessories such as jumper bars may modify the terminal block's ratings: Complete information available in the accessories section of the catalog.

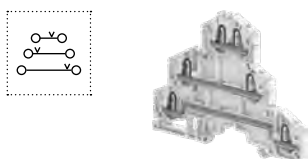

## Feed-through PI-Spring terminal blocks

Description	Color	Type	Part Number	Pkg qty	Weight (1 pce)
Feed-through	Grey	ZK2.5-T3	1SNK705510R0000	25	17.33

Technical data valid for copper conductors only.



# ZK2.5-L-N-PE PI-Spring terminal blocks

Triple deck with 2 feed-through circuits and 1 ground circuit - 5.2 mm 0.205 in spacing



1SNK162113W0014

ZK2.5-L-N-PE

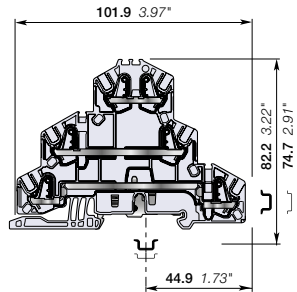

5.2 mm 0.205 in spacing

## Description

Combine high performance with compact dimensions:

- 500 V IEC 300 V UL,
- 2 feed through circuits, phase and neutral, and 1 ground circuit in just 5.2 mm 0.205 in spacing,
- 1 jumper channel and a large input and output marker zone on each deck,
- designed for easy wiring.

## Ordering details

Description	Color	Type	Part Number	Pkg qty	Weight (1 pce) g
Feed-through + ground	Blue, grey, Green-yellow	ZK2.5-L-N-PE	1SNK705513R0000	25	21.38

## Main technical data

Connecting capacity		IEC	UL - CSA	Mounting instructions	
1 conductor per clamp	Rigid: Solid/Stranded	0.2 ... 4 mm²	26 ... 12 AWG	Rail	 TH 35-7.5, TH 35-15
	Flexible without ferrule	0.22 ... 2.5 mm²	26 ... 14 AWG		
	Flexible with non insulated ferrule	0.22 ... 2.5 mm²	26 ... 14 AWG	Wire stripping length	 11 mm 0.433 in
	Flexible with insulated ferrule	0.22 ... 2.5 mm²	26 ... 14 AWG		
2 conductors per clamp	Flexible with twin ferrule	0.22 ... 0.5 mm²	26 ... 20 AWG	Tool (for flexible conductor without ferrule)	 Flat screwdriver Ø 3.5 mm Ø 0.138 in
<b>Rated current / Rated cross section</b>		22 A / 2.5 mm²	20 A / 12 AWG		
<b>Rated short-time withstand current (1s)</b>		300 A	396 A		
<b>Short Circuit Current Rating</b> (with specific conditions)					
<b>Rated voltage</b>		500 V	300 V		
<b>Impulse withstand voltage</b>		8000 V			
<b>Protection</b>		IP20	NEMA 1		
<b>Increased safety Ex e</b>		440 V 20 A IEC/EN 60079-7 - IM2 II 2 GD Ex eb I/IC/IIIC			

The connecting capacity data for one Rigid: Solid/Stranded, or one Flexible conductor (when applicable) is a mandatory information required by IEC, UL and CSA standards (Copper conductors). All other data are provided as supplementary information only. For more details, please consult our CB, UL or CSA certificates and technical datasheet available on <http://www.TE.com>



## Accessories

Description	Color	Type	Part Number	Pkg qty	Weight (1 pce) g	
1 End stops	Dark grey	BAZH1	1SNK900102R0000	20	24.00	
2 End sections	Dark grey	EK2.5-T3	1SNK705961R0000	20	4.76	
3 Jumper bars	Orange	2 poles	JB5-2	1SNK905302R0000	50	1.30
		3 poles	JB5-3	1SNK905303R0000	50	2.00
		4 poles	JB5-4	1SNK905304R0000	50	2.70
		5 poles	JB5-5	1SNK905305R0000	50	3.50
		10 poles	JB5-10	1SNK905310R0000	30	7.10
		50 poles	JB5-50	1SNK905350R0000	10	36.00
4 Test adapters	Dark grey	For test plugs DIA 2 mm 0.079 in	TP2	1SNK900203R0000	20	1.70
		For test plugs DIA 4 mm 0.157 in	TP4	1SNK900205R0000	20	2.40
5 Test connectors	Dark grey	5.2 mm 0.205 in spacing	TC5	1SNK900200R0000	10	5.20
		End module, 5.2 mm 0.205 in	TC5-R1	1SNK900201R0000	10	5.20
6 Label holders	Dark grey	LH-J	1SNK900606R0000	100	0.73	
7 Terminal block markers	Blank marker	White	MG-CPM 13 41790	1SNB041790R0512	1960	0.23
			MC512	1SNK140000R0000	22	9.00
	Blank card	Grey	MC512PA	1SNK149999R0000	20	10.00
			Universal wire markers holder	UMH	1SNK900611R0000	10

Complete list of accessories is indicated in the terminal block datasheet including end stops. Some accessories such as jumper bars may modify the terminal block's ratings: Complete information available in the accessories section of the catalog.

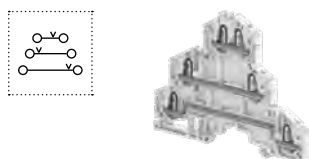

## Feed-through PI-Spring terminal blocks

Description	Color	Type	Part Number	Pkg qty	Weight (1 pce) g
Feed-through	Grey	ZK2.5-T3	1SNK705510R0000	25	17.33

Technical data valid for copper conductors only.



# ZK2.5-T1-PE PI-Spring terminal blocks

Triple deck with 1 ground circuit - 5.2 mm 0.205 in spacing

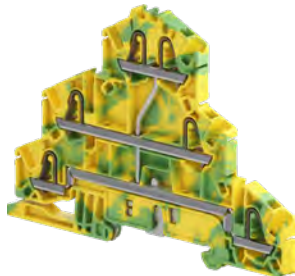

1SNK16211R0014

ZK2.5-T1-PE

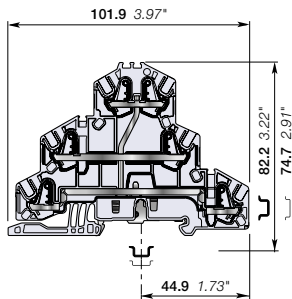

5.2 mm 0.205 in spacing

## Description

Improve the safety of your installation in the event of a short-circuit thanks to our screwless rail contact:

- Rail contact non operator dependent,
- Performances above the requirements of the IEC 60947-7-2 terminal block standard,
- Secured snap on or off the rail,
- Profile aligned with ZK2.5-T3,
- 1 jumper channel on bottom and middle decks.

## Ordering details

Description	Color	Type	Part Number	Pkg qty	Weight (1 pce) g
Ground 1 ground circuit	Green-yellow	ZK2.5-T1-PE	1SNK705550R0000	25	21.53

## Main technical data

Connecting capacity		IEC	UL - CSA
1 conductor per clamp	Rigid: Solid/Stranded	0.2 ... 4 mm <sup>2</sup>	26 ... 12 AWG
	Flexible without ferrule	0.22 ... 2.5 mm <sup>2</sup>	
	Flexible with non insulated ferrule	0.22 ... 2.5 mm <sup>2</sup>	26 ... 14 AWG
	Flexible with insulated ferrule	0.22 ... 2.5 mm <sup>2</sup>	26 ... 14 AWG
Rated cross section		2.5 mm <sup>2</sup>	12 AWG
Rated short-time withstand current (1s)		300 A	396 A
Protection		IP20	NEMA 1

## Mounting instructions

Rail		TH 35-7.5, TH 35-15
Wire stripping length		11 mm 0.433 in
Tool (for flexible conductor without ferrule)		Flat screwdriver Ø 3.5 mm Ø 0.138 in

## Explosive atmosphere classification

IM2 II 2 GD Ex eb I/IC/IIIC  
The connecting capacity data for one Rigid: Solid/Stranded, or one Flexible conductor (when applicable) is a mandatory information required by IEC, UL and CSA standards (Copper conductors). All other data are provided as supplementary information only. For more details, please consult our CB, UL or CSA certificates and technical datasheet available on <http://www.TE.com>



## Accessories

Description	Color	Type	Part Number	Pkg qty	Weight (1 pce) g
1 End stops 10 mm 0.394 in	Dark grey	BZH1	1SNK900102R0000	20	24.00
2 End sections 0.8 mm 0.031 in	Dark grey	EK2.5-T3	1SNK705961R0000	20	4.76
3 Test adapters For test plugs DIA 2 mm 0.079 in For test plugs DIA 4 mm 0.157 in	Dark grey	TP2	1SNK900203R0000	20	1.70
		TP4	1SNK900205R0000	20	2.40
4 Test connectors 5.2 mm 0.205 in spacing End module, 5.2 mm 0.205 in	Dark grey	TC5	1SNK900200R0000	10	5.20
		TC5-R1	1SNK900201R0000	10	5.20
5 Label holders	Dark grey	LH-J	1SNK900606R0000	100	0.73
6 Terminal block markers Blank marker Blank card Universal wire markers holder	White	MG-CPM 13 41790	1SNB041790R0512	1960	0.23
		MC512	1SNK140000R0000	22	9.00
		MC512PA	1SNK149999R0000	20	10.00
	Grey	UMH	1SNK900611R0000	10	0.20

Complete list of accessories is indicated in the terminal block datasheet including end stops.

Some accessories such as jumper bars may modify the terminal block's ratings: Complete information available in the accessories section of the catalog.

Technical data valid for copper conductors only.

# ZK2.5-CH-4P-LR PI-Spring terminal blocks

## Component holder - 5.2 mm 0.205 in spacing



2.5 mm<sup>2</sup>  
12 AWG

### Description

- Protect your circuit with one 1N4007 diode,
- Clear identification of the diode orientation with marking identification on the top of the terminal block

### Ordering details

Description	Color	Type	Part Number	Pkg qty	Weight (1 pce) g
Component holder with 1 test socket DIA 2 mm 0.079 in	Grey <input type="checkbox"/>	ZK2.5-CH-4P-LR	1SNK705710R0000	50	10.91

### Main technical data

Connecting capacity	IEC	UL - CSA	Mounting instructions
<b>1 conductor per clamp</b>	Rigid: Solid/Stranded Flexible without ferrule Flexible with non insulated ferrule Flexible with insulated ferrule	0.2 ... 4 mm <sup>2</sup> 0.22 ... 2.5 mm <sup>2</sup> 0.22 ... 2.5 mm <sup>2</sup> 0.22 ... 2.5 mm <sup>2</sup>	26 ... 12 AWG 26 ... 14 AWG 26 ... 14 AWG 26 ... 14 AWG
<b>2 conductors per clamp</b>	Flexible with twin ferrule	0.22 ... 0.5 mm <sup>2</sup>	26 ... 20 AWG
<b>Rated current / Rated cross section</b>	1 A / 2.5 mm <sup>2</sup>	1 A / 12 AWG	
<b>Rated short-time withstand current (1s)</b>			
<b>Short Circuit Current Rating (with specific conditions)</b>			
<b>Rated voltage</b>	630 V	300 V	
<b>Impulse withstand voltage</b>			
<b>Protection</b>	IP20	NEMA 1	

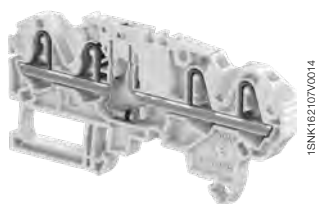

ZK2.5-CH-4P

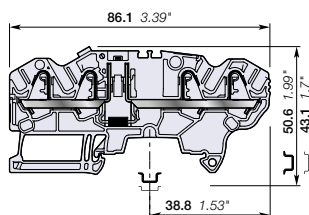

5.2 mm 0.205 in spacing

### Mounting instructions

Mounting instructions	Tool	Weight
Rail	TH 35-7.5, TH 35-15	
Wire stripping length	11 mm 0.433 in	
Tool (for flexible conductor without ferrule)	Flat screwdriver Ø 3.5 mm Ø 0.138 in	

The connecting capacity data for one Rigid: Solid/Stranded, or one Flexible conductor (when applicable) is a mandatory information required by IEC, UL and CSA standards (Copper conductors). All other data are provided as supplementary information only. For more details, please consult our CB, UL or CSA certificates and technical datasheet available on <http://www.TE.com>

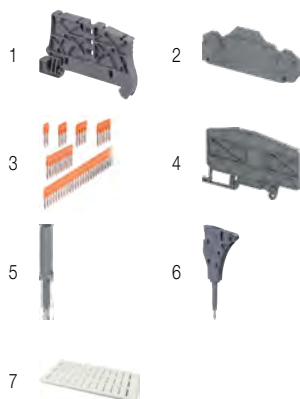

### Accessories

Description	Color	Type	Part Number	Pkg qty	Weight (1 pce) g	
<b>1 End stops</b> 5.2 mm 0.205 in	Dark grey <input type="checkbox"/>	BAZ1	1SNK900002R0000	50	5.30	
<b>2 End sections</b> 2 mm 0.158 in	Dark grey <input type="checkbox"/>	EK2.5-S-4P	1SNK705913R0000	20	2.94	
<b>3 Jumper bars</b>	Orange <input type="checkbox"/>	2 poles 32 A (IEC)	JB5-2	1SNK905302R0000	50	1.30
		3 poles 32 A (IEC)	JB5-3	1SNK905303R0000	50	2.00
		4 poles 32 A (IEC)	JB5-4	1SNK905304R0000	50	2.70
		5 poles 32 A (IEC)	JB5-5	1SNK905305R0000	50	3.50
		10 poles 32 A (IEC)	JB5-10	1SNK905310R0000	30	7.10
		50 poles 32 A (IEC)	JB5-50	1SNK905350R0000	10	36.00
<b>4 Circuit separators</b> 3 mm 0.118 in	Dark grey <input type="checkbox"/>	CS-R3	1SNK900107R0000	20	6.40	
<b>5 Test adapters</b>	Dark grey <input type="checkbox"/>	For test plugs DIA 2 mm 0.079 in	TP2	1SNK900203R0000	20	1.70
		For test plugs DIA 4 mm 0.157 in	TP4	1SNK900205R0000	20	2.40
<b>6 Test connectors</b>	Dark grey <input type="checkbox"/>	5.2 mm 0.205 in spacing	TC5	1SNK900200R0000	10	5.20
		End module, 5.2 mm 0.205 in	TC5-R1	1SNK900201R0000	10	5.20
<b>7 Terminal block markers</b>	White <input type="checkbox"/>	Blank marker	MG-CPM 13 41790	1SNK041790R0512	1960	0.23
		Blank card	MC512	1SNK140000R0000	22	9.00
			MC512PA	1SNK149999R0000	20	10.00
		Universal wire markers holder	Grey <input type="checkbox"/>	UMH	1SNK900611R0000	10

Complete list of accessories is indicated in the terminal block datasheet including end stops. Some accessories such as jumper bars may modify the terminal block's ratings: Complete information available in the accessories section of the catalog.

Technical data valid for copper conductors only.

# ZK2.5-CH-4P-RL PI-Spring terminal blocks

## Component holder - 5.2 mm 0.205 in spacing



ZK2.5-CH-4P

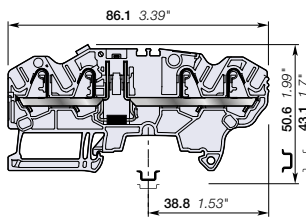

5.2 mm 0.205 in spacing

### Description

- Protect your circuit with one 1N4007 diode,
- Clear identification of the diode orientation with marking identification on the top of the terminal block

### Ordering details

Description	Color	Type	Part Number	Pkg qty	Weight (1 pce) g
Component holder with 1 test socket DIA 2 mm 0.079 in	Grey <input type="checkbox"/>	ZK2.5-CH-4P-RL	1SNK705711R0000	50	10.91

### Main technical data

Connecting capacity	IEC	UL - CSA	Mounting instructions	
<b>1 conductor per clamp</b>	Rigid: Solid/Stranded Flexible without ferrule Flexible with non insulated ferrule Flexible with insulated ferrule	0.2 ... 4 mm <sup>2</sup> 0.22 ... 2.5 mm <sup>2</sup> 0.22 ... 2.5 mm <sup>2</sup> 0.22 ... 2.5 mm <sup>2</sup>	26 ... 12 AWG 26 ... 14 AWG 26 ... 14 AWG	Rail  TH 35-7.5, TH 35-15 Wire stripping length  11 mm 0.433 in
<b>2 conductors per clamp</b>	Flexible with twin ferrule	0.22 ... 0.5 mm <sup>2</sup>	26 ... 20 AWG	Tool (for flexible conductor without ferrule)  Flat screwdriver Ø 3.5 mm Ø 0.138 in
<b>Rated current / Rated cross section</b>		1 A / 2.5 mm <sup>2</sup>	1 A / 12 AWG	
<b>Rated short-time withstand current (1s)</b>				
<b>Short Circuit Current Rating (with specific conditions)</b>				
<b>Rated voltage</b>		630 V	300 V	
<b>Impulse withstand voltage</b>				
<b>Protection</b>		IP20	NEMA 1	

The connecting capacity data for one Rigid: Solid/Stranded, or one Flexible conductor (when applicable) is a mandatory information required by IEC, UL and CSA standards (Copper conductors). All other data are provided as supplementary information only. For more details, please consult our CB, UL or CSA certificates and technical datasheet available on <http://www.TE.com>

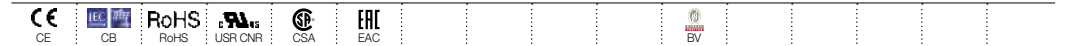

### Accessories

Description	Color	Type	Part Number	Pkg qty	Weight (1 pce) g
<b>1 End stops</b> 5.2 mm 0.205 in	Dark grey <input checked="" type="checkbox"/>	BAZ1	1SNK900002R0000	50	5.30
<b>2 End sections</b> 2 mm 0.158 in	Dark grey <input checked="" type="checkbox"/>	EK2.5-S-4P	1SNK705913R0000	20	2.94
<b>3 Jumper bars</b>	Orange <input checked="" type="checkbox"/>	JB5-2	1SNK905302R0000	50	1.30
2 poles 32 A (IEC)		JB5-3	1SNK905303R0000	50	2.00
3 poles 32 A (IEC)		JB5-4	1SNK905304R0000	50	2.70
4 poles 32 A (IEC)		JB5-5	1SNK905305R0000	50	3.50
5 poles 32 A (IEC)		JB5-10	1SNK905310R0000	30	7.10
10 poles 32 A (IEC)		JB5-50	1SNK905350R0000	10	36.00
50 poles 32 A (IEC)					
<b>4 Circuit separators</b> 3 mm 0.118 in	Dark grey <input checked="" type="checkbox"/>	CS-R3	1SNK900107R0000	20	6.40
<b>5 Test adapters</b>	Dark grey <input checked="" type="checkbox"/>	TP2	1SNK900203R0000	20	1.70
For test plugs DIA 2 mm 0.079 in		TP4	1SNK900205R0000	20	2.40
For test plugs DIA 4 mm 0.157 in					
<b>6 Test connectors</b> 5.2 mm 0.205 in spacing	Dark grey <input checked="" type="checkbox"/>	TC5	1SNK900200R0000	10	5.20
End module, 5.2 mm 0.205 in		TC5-R1	1SNK900201R0000	10	5.20
<b>7 Terminal block markers</b>	White <input type="checkbox"/>	MG-CPM 13 41790	1SNB041790R0512	1960	0.23
Blank marker		MC512	1SNK140000R0000	22	9.00
Blank card		MC512PA	1SNK149999R0000	20	10.00
Universal wire markers holder	Grey <input type="checkbox"/>	UMH	1SNK900611R0000	10	0.20

Complete list of accessories is indicated in the terminal block datasheet including end stops. Some accessories such as jumper bars may modify the terminal block's ratings: Complete information available in the accessories section of the catalog.

Technical data valid for copper conductors only.

# ZK2.5-D-CH-UD PI-Spring terminal blocks

## Component holder - 5.2 mm 0.205 in spacing



ZK2.5-D-CH

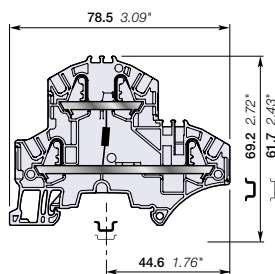

5.2 mm 0.205 in spacing

### Description

Protect your circuit with one 1N4007 diode.

### Ordering details

Description	Color	Type	Part Number	Pkg qty	Weight (1 pce) g
Component holder	Grey <input type="checkbox"/>	ZK2.5-D-CH-UD	1SNK705213R0000	50	11.20

### Main technical data

Connecting capacity		IEC	UL - CSA	Mounting instructions	
1 conductor per clamp	Rigid: Solid/Stranded	0.2 ... 4 mm <sup>2</sup>	26 ... 12 AWG	Rail	TH 35-7.5, TH 35-15
	Flexible without ferrule	0.22 ... 2.5 mm <sup>2</sup>		Wire stripping length	11 mm 0.443 in
	Flexible with non insulated ferrule	0.22 ... 2.5 mm <sup>2</sup>	26 ... 14 AWG	Tool (for flexible conductor without ferrule)	Flat screwdriver Ø 3.5 mm Ø 0.138 in
	Flexible with insulated ferrule	0.22 ... 2.5 mm <sup>2</sup>	26 ... 14 AWG		
2 conductors per clamp	Flexible with twin ferrule	0.22 ... 0.5 mm <sup>2</sup>	26 ... 20 AWG		
<b>Rated current / Rated cross section</b>		24 A / 2.5 mm <sup>2</sup>	20 A / 12 AWG		
<b>Rated short-time withstand current (1s)</b>		300 A			
<b>Short Circuit Current Rating (with specific conditions)</b>					
<b>Rated voltage</b>		800 V	600 V		
<b>Impulse withstand voltage</b>					
<b>Protection</b>		IP20	NEMA 1		

The connecting capacity data for one Rigid: Solid/Stranded, or one Flexible conductor (when applicable) is a mandatory information required by IEC, UL and CSA standards (Copper conductors). All other data are provided as supplementary information only. For more details, please consult our CB, UL or CSA certificates and technical datasheet available on <http://www.TE.com>

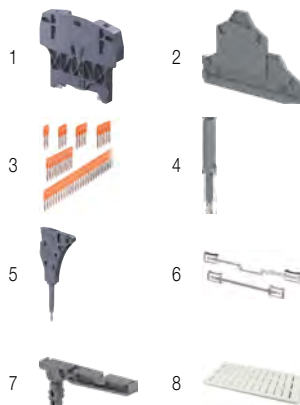
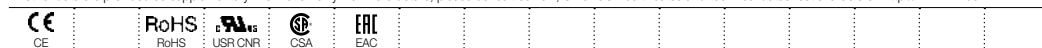

### Accessories

Description	Color	Type	Part Number	Pkg qty	Weight (1 pce) g	
1 End stops	Dark grey <input type="checkbox"/>	BAZH1	1SNK900102R0000	20	24.00	
2 End sections	Dark grey <input type="checkbox"/>	EK2.5-D2	1SNK705960R0000	20	3.40	
3 Jumper bars	Orange <input type="checkbox"/>	2 poles	JB5-2	1SNK905302R0000	50	1.30
		3 poles	JB5-3	1SNK905303R0000	50	2.00
		4 poles	JB5-4	1SNK905304R0000	50	2.70
		5 poles	JB5-5	1SNK905305R0000	50	3.50
		10 poles	JB5-10	1SNK905310R0000	30	7.10
		50 poles	JB5-50	1SNK905350R0000	10	36.00
4 Test adapters	Dark grey <input type="checkbox"/>	For test plugs DIA 2 mm 0.079 in	TP2	1SNK900203R0000	20	1.70
		For test plugs DIA 4 mm 0.157 in	TP4	1SNK900205R0000	20	2.40
5 Test connectors	Dark grey <input type="checkbox"/>	5.2 mm 0.205 in spacing	TC5	1SNK900200R0000	10	5.20
		End module, 5.2 mm 0.205 in	TC5-R1	1SNK900201R0000	10	5.20
6 Shield connectors		SHB	1SNK900602R0000	20	4.90	
7 Label holders	Dark grey <input type="checkbox"/>	LH-J	1SNK900606R0000	100	0.73	
8 Terminal block markers	White <input type="checkbox"/>	Blank marker	MG-CPM 13 41790	1SNB041790R0512	1960	0.23
		Blank card	MC512	1SNK140000R0000	22	9.00
			MC512PA	1SNK149999R0000	20	10.00
	Universal wire markers holder	Grey <input type="checkbox"/>	UMH	1SNK900611R0000	10	0.20

Complete list of accessories is indicated in the terminal block datasheet including end stops. Some accessories such as jumper bars may modify the terminal block's ratings. Complete information available in the accessories section of the catalog.

Technical data valid for copper conductors only.

# ZK2.5-D-CH-DU PI-Spring terminal blocks

## Component holder - 5.2 mm 0.205 in spacing



2.5 mm<sup>2</sup>  
12 AWG

### Description

Protect your circuit with one 1N4007 diode.

### Ordering details

Description	Color	Type	Part Number	Pkg qty	Weight (1 pce) g
Component holder	Grey <input type="checkbox"/>	ZK2.5-D-CH-DU	1SNK705214R0000	50	11.20

### Main technical data

Connecting capacity		IEC	UL - CSA	Mounting instructions	
1 conductor per clamp	Rigid: Solid/Stranded	0.2 ... 4 mm <sup>2</sup>	26 ... 12 AWG	Rail	TH 35-7.5, TH 35-15
	Flexible without ferrule	0.22 ... 2.5 mm <sup>2</sup>		Wire stripping length	11 mm
	Flexible with non insulated ferrule	0.22 ... 2.5 mm <sup>2</sup>	26 ... 14 AWG		0.443 in
	Flexible with insulated ferrule	0.22 ... 2.5 mm <sup>2</sup>	26 ... 14 AWG		
2 conductors per clamp	Flexible with twin ferrule	0.22 ... 0.5 mm <sup>2</sup>	26 ... 20 AWG	Tool (for flexible conductor without ferrule)	Flat screwdriver Ø 3.5 mm Ø 0.138 in
Rated current / Rated cross section		24 A / 2.5 mm <sup>2</sup>	20 A / 12 AWG		
Rated short-time withstand current (1s)		300 A			
Short Circuit Current Rating (with specific conditions)					
Rated voltage		800 V	600 V		
Impulse withstand voltage					
Protection		IP20	NEMA 1		

The connecting capacity data for one Rigid: Solid/Stranded, or one Flexible conductor (when applicable) is a mandatory information required by IEC, UL and CSA standards (Copper conductors). All other data are provided as supplementary information only. For more details, please consult our CB, UL or CSA certificates and technical datasheet available on <http://www.TE.com>

CE	RoHS	UL	CSA	ERC	EAC
----	------	----	-----	-----	-----



1SNK16210200014

ZK2.5-D-CH

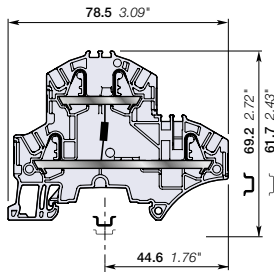

5.2 mm 0.205 in spacing

### Accessories

Description	Color	Type	Part Number	Pkg qty	Weight (1 pce) g	
1 End stops	Dark grey <input checked="" type="checkbox"/>	BAZH1	1SNK900102R0000	20	24.00	
2 End sections	Dark grey <input checked="" type="checkbox"/>	EK2.5-D2	1SNK705960R0000	20	3.40	
3 Jumper bars	Orange <input checked="" type="checkbox"/>	2 poles 32 A (IEC)	JB5-2	1SNK905302R0000	50	1.30
		3 poles 32 A (IEC)	JB5-3	1SNK905303R0000	50	2.00
		4 poles 32 A (IEC)	JB5-4	1SNK905304R0000	50	2.70
		5 poles 32 A (IEC)	JB5-5	1SNK905305R0000	50	3.50
		10 poles 32 A (IEC)	JB5-10	1SNK905310R0000	30	7.10
		50 poles 32 A (IEC)	JB5-50	1SNK905350R0000	10	36.00
4 Test adapters	Dark grey <input checked="" type="checkbox"/>	For test plugs DIA 2 mm 0.079 in	TP2	1SNK900203R0000	20	1.70
		For test plugs DIA 4 mm 0.157 in	TP4	1SNK900205R0000	20	2.40
5 Test connectors	Dark grey <input checked="" type="checkbox"/>	5.2 mm 0.205 in spacing	TC5	1SNK900200R0000	10	5.20
		End module, 5.2 mm 0.205 in	TC5-R1	1SNK900201R0000	10	5.20
6 Shield connectors		SHB	1SNK900602R0000	20	4.90	
7 Label holders	Dark grey <input checked="" type="checkbox"/>	LH-J	1SNK900606R0000	100	0.73	
8 Terminal block markers	White <input type="checkbox"/>	Blank marker	MG-CPM 13 41790	1SNB041790R0512	1960	0.23
		Blank card	MC512	1SNK140000R0000	22	9.00
			MC512PA	1SNK149999R0000	20	10.00
	Universal wire markers holder	Grey <input type="checkbox"/>	UMH	1SNK900611R0000	10	0.20

Complete list of accessories is indicated in the terminal block datasheet including end stops. Some accessories such as jumper bars may modify the terminal block's ratings: Complete information available in the accessories section of the catalog.

Technical data valid for copper conductors only.



# ZK2.5-D-CH2-DU-RL PI-Spring terminal blocks

## Component holder - 5.2 mm 0.205 in spacing



### Description

- Protect your circuit with 1N4007 diodes;
- Convenient identification of the diodes orientation on the terminal block front side.

### Ordering details

Description	Color	Type	Part Number	Pkg qty	Weight (1 pce) g
Component holder	Grey <input type="checkbox"/>	ZK2.5-D-CH2-DU-RL	1SNK705219R0000	50	11.20

### Main technical data

Connecting capacity		IEC	UL - CSA	Mounting instructions	
1 conductor per clamp	Rigid: Solid/Stranded	0.2 ... 4 mm <sup>2</sup>	26 ... 12 AWG	Rail	TH 35-7.5, TH 35-15
	Flexible without ferrule	0.22 ... 2.5 mm <sup>2</sup>		Wire stripping length	11 mm 0.443 in
	Flexible with non insulated ferrule	0.22 ... 2.5 mm <sup>2</sup>	26 ... 14 AWG		
	Flexible with insulated ferrule	0.22 ... 2.5 mm <sup>2</sup>	26 ... 14 AWG		
2 conductors per clamp	Flexible with twin ferrule	0.22 ... 0.5 mm <sup>2</sup>	26 ... 20 AWG	Tool (for flexible conductor without ferrule)	Flat screwdriver Ø 3.5 mm Ø 0.138 in
Rated current / Rated cross section		1 A / 2.5 mm <sup>2</sup> / 12 AWG			
Rated short-time withstand current (1s)					
Short Circuit Current Rating (with specific conditions)					
Rated voltage		800 V	600 V		
Impulse withstand voltage					
Protection		IP20	NEMA 1		



1SNK162114V0014

ZK2.5-D-CH2

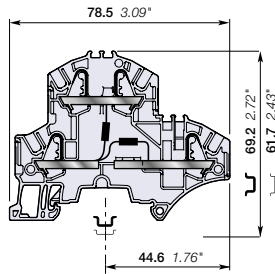

5.2 mm 0.205 in spacing

The connecting capacity data for one Rigid: Solid/Stranded, or one Flexible conductor (when applicable) is a mandatory information required by IEC, UL and CSA standards (Copper conductors). All other data are provided as supplementary information only. For more details, please consult our CB, UL or CSA certificates and technical datasheet available on <http://www.TE.com>

--	--	--	--	--	--	--	--	--	--

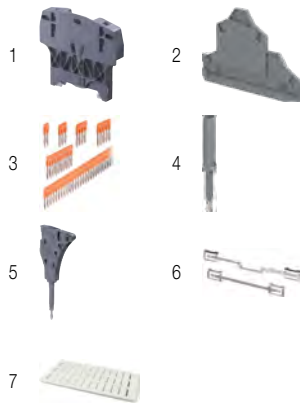

### Accessories

Description	Color	Type	Part Number	Pkg qty	Weight (1 pce) g	
1 End stops	Dark grey <input type="checkbox"/>	BAZH1	1SNK900102R0000	20	24.00	
2 End sections	Dark grey <input type="checkbox"/>	EK2.5-D2	1SNK705960R0000	20	3.40	
3 Jumper bars	Orange <input type="checkbox"/>	2 poles	JB5-2	1SNK905302R0000	50	1.30
		3 poles	JB5-3	1SNK905303R0000	50	2.00
		4 poles	JB5-4	1SNK905304R0000	50	2.70
		5 poles	JB5-5	1SNK905305R0000	50	3.50
		10 poles	JB5-10	1SNK905310R0000	30	7.10
		50 poles	JB5-50	1SNK905350R0000	10	36.00
4 Test adapters	Dark grey <input type="checkbox"/>	For test plugs DIA 2 mm 0.079 in	TP2	1SNK900203R0000	20	1.70
		For test plugs DIA 4 mm 0.157 in	TP4	1SNK900205R0000	20	2.40
5 Test connectors	Dark grey <input type="checkbox"/>	5.2 mm 0.205 in spacing	TC5	1SNK900200R0000	10	5.20
		End module, 5.2 mm 0.205 in	TC5-R1	1SNK900201R0000	10	5.20
			SHB	1SNK900602R0000	20	4.90
6 Shield connectors	White <input type="checkbox"/>	Blank marker	MG-CPM 13 41790	1SNB041790R0512	1960	0.23
		Blank card	MC512	1SNK140000R0000	22	9.00
			MC512PA	1SNK149999R0000	20	10.00
		Universal wire markers holder	Grey <input type="checkbox"/>	UMH	1SNK900611R0000	10

Complete list of accessories is indicated in the terminal block datasheet including end stops. Some accessories such as jumper bars may modify the terminal block's ratings: Complete information available in the accessories section of the catalog.

Technical data valid for copper conductors only.



# SNK series, terminal blocks

## Screw clamp technology



Technologies presentation		72
Overview		76
<b>Feed-through</b>		
4 mm <sup>2</sup> / 12 AWG	ZS4	80
6 mm <sup>2</sup> / 10 AWG	ZS6	81
	ZS6-3S and ZS6-4S	with 3 and 4 connections 82-83
10 mm <sup>2</sup> / 6 AWG	ZS10	84
16 mm <sup>2</sup> / 4 AWG	ZS16	85
25 mm <sup>2</sup> / 3 AWG	ZS25	86
35 mm <sup>2</sup> / 0 AWG	ZS35	87
50 mm <sup>2</sup> / 0 AWG	ZS50	88
70 mm <sup>2</sup> / 00 AWG	ZS70	89
95 mm <sup>2</sup> / 0000 AWG	ZS95	90
150 mm <sup>2</sup> / 350 Kcmil	ZS150	91
240 mm <sup>2</sup> / 240 Kcmil	ZS240	92
<b>Ground</b>		
4 mm <sup>2</sup> / 12 AWG	ZS4-PE	93
6 mm <sup>2</sup> / 10 AWG	ZS6-PE	94
	ZS6-3S-PE and ZS6-4S-PE	with 3 and 4 connections 95-96
10 mm <sup>2</sup> / 6 AWG	ZS10-PE	97
16 mm <sup>2</sup> / 4 AWG	ZS16-PE	98
25 mm <sup>2</sup> / 3 AWG	ZS25-PE	99
35 mm <sup>2</sup> / 2 AWG	ZS35-PE	100
35 mm <sup>2</sup>	ZS35-PEN	+ neutral 101
50 mm <sup>2</sup> / 0 AWG	ZS50-PE	102
70 mm <sup>2</sup> / 00 AWG	ZS70-PE	103
95 mm <sup>2</sup> / 0000 AWG	ZS95-PE	104
<b>Disconnect with blade</b>		
4 mm <sup>2</sup> / 10 AWG	ZS4-S, ZS4-S-T, ZS4-S-R1 and ZS4-S-T-R1	with test 105-108
6 mm <sup>2</sup> / 10 AWG	ZS6-S and ZS6-S-4S-T	with test 109-110
10 mm <sup>2</sup> / 6 AWG	ZS10-S	111
<b>Disconnect with plug</b>		
4 mm <sup>2</sup> / 10 AWG	ZS4-SP, ZS4-SP-T2, ZS4-SP-R1 and ZS4-SP-T2-R1	with test 112-115
10 mm <sup>2</sup> / 6 AWG	ZS10-SP	116
<b>Fuse and marshalling cabinets application overview</b>		
		118
<b>For 5x20 and 5x25 mm fuses</b>		
4 mm <sup>2</sup> / 10 AWG	ZS4-SF1 and ZS4-SF1-T	with test 120-121
	ZS4-SF1-R	with fuse indicator and test 122-123
	ZS4-R1	feed-through 124
	ZS4-S-R3	disconnect with lever 125
<b>For 5x20 mm fuses and marshalling cabinets application</b>		
4 mm <sup>2</sup> / 10 AWG	ZS4-SF	126
	ZS4-SF-T	with test 127
	ZS4-SF-R	with fuse indicator and test 128-129
	ZS4-R2	feed-through 130
	ZS4-PE-R2	ground 131
	ZS4-S-R2	disconnect with lever 132
<b>For 6.3x32 mm fuses (¼ x 1¼ in)</b>		
10 mm <sup>2</sup> / 6 AWG	ZS10-SF	133
	ZS10-SF-R	with fuse indicator 134
	ZS10-S-R2	disconnect with lever 135
<b>Double deck</b>		
4 mm <sup>2</sup> / 12 AWG	ZS4-D2 and ZS4-D1	2 and 1 feed-through circuits 136-137
6 mm <sup>2</sup> / 10 AWG	ZS6-D2 and ZS6-D1	2 and 1 feed-through circuits 138-139
	ZS6-D2-PE	1 feed-through circuit and 1 ground circuit 140
	ZS6-D1-PE	1 ground circuit 141
4 mm <sup>2</sup> / 10 AWG	ZS4-D2-S	1 disconnect circuit and 1 feed-through circuit 142
	ZS4-D2-S-T	1 disconnect circuit + test and 1 feed-through circuit 143
	ZS4-D2-SF1	1 fuse circuit and 1 feed-through circuit 144
	ZS4-D2-SF1-R	1 fuse circuit + fuse indicator and 1 feed-through circuit 145
<b>Triple deck</b>		
4 mm <sup>2</sup> / 12 AWG	ZS4-T3	3 feed-through circuits 146
4 mm <sup>2</sup> / 10 AWG	ZS4-T3-R1	3 feed-through circuits 147
<b>Component holder</b>		
4 mm <sup>2</sup> / 12 AWG	ZS4-D-CH-UD and ZS4-D-CH-DU	148-149
<b>Test and measurement</b>		
<b>Overview</b>		
10 mm <sup>2</sup> / 6 AWG	ZS10-ST	150
	ZS10-ST-1	for Potential Transformer circuits 154
	ZS10-ST-T4	for Current Transformer circuits 155
	ZS10-R1	feed-through 156
	ZS10-PE-R1	ground 157
		158

## Screw clamp technology - SNK series, terminal blocks

### Features and benefits

TE Connectivity screw clamp technology benefits from 60 years of experience.

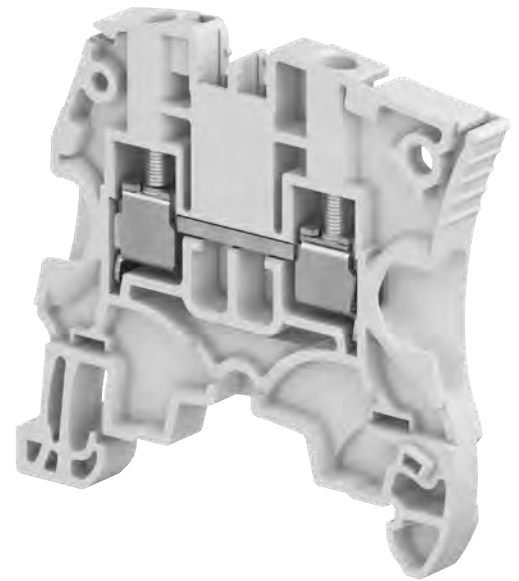

### Speed up your projects

#### An optimized conductor guiding

Smooth connection process up to 2 conductors with or without ferrules thanks to funnel entry shape.

Also perfectly adapted to double ferrule shape **1**

Security: flap avoiding the insertion of cable underneath the clamp **2**.

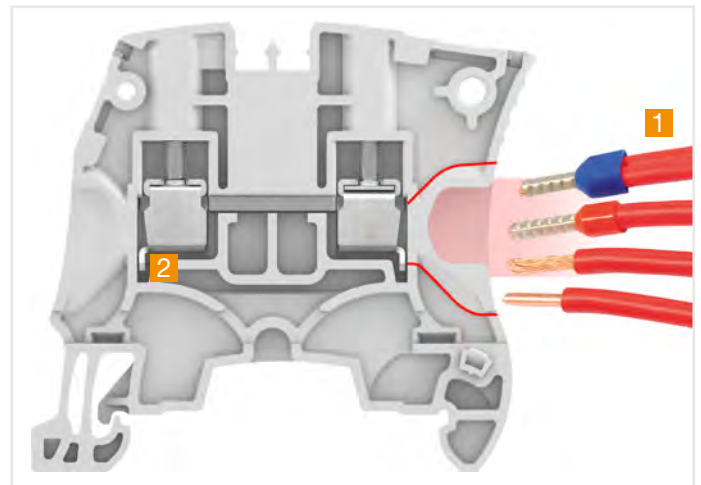

Engineered conductor entry

#### Better project identification

- Circuit identification is improved thanks to the 20% larger marking area
- Pre-mark by hand or with label on our flat marking surface and start immediately the wiring, before the final markers mounting
- Spare markers re-printing in case of modifications.

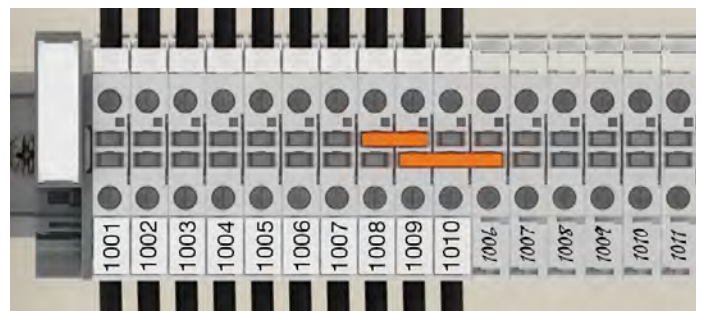

Clear circuit identification

1SNK161092S0201

## Screw clamp technology - SNK series, terminal blocks

### Features and benefits

#### Easy to install

##### Smart design facilitating assembly process.

Mounting, wiring, testing... made easy.

Avoid mounting and wiring errors: asymmetrical design allows immediate visual check in case of reversed terminal blocks.

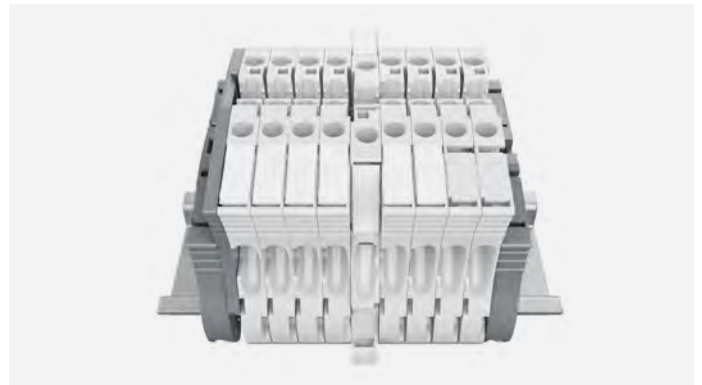

Asymmetrical design avoids mounting error

##### Minimize retightening campaigns

High torque resistance : the clamp is punched to increase the number of threads in contact by 30 % **1**.

The TE Connectivity exclusive anti-release system creates a controlled locking-screw effect reinforced by the 2 overlapping tabs that maintain the clamp parts **2**.

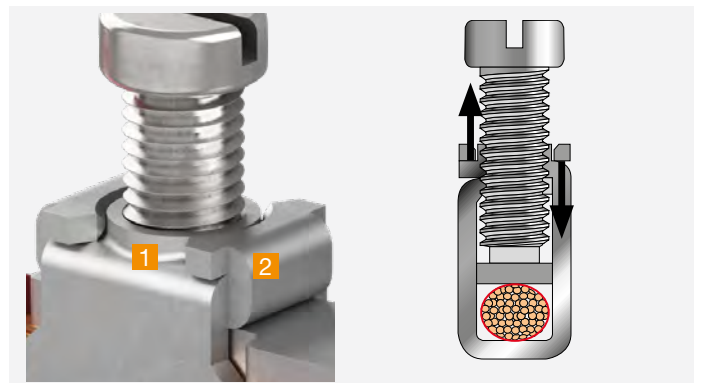

High torque resistance

Anti-release system

##### Faster accessories mounting

Save up to 70% mounting time thanks to screwless accessories: jumpers, component plugs, test devices, end stops and snap-in ground terminal blocks.

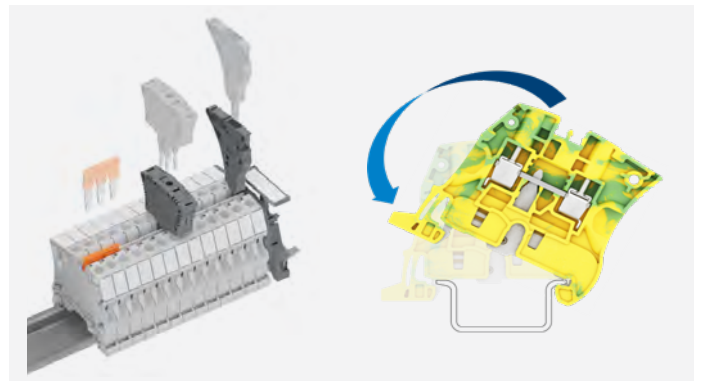

Screwless accessories

Snap-in ground terminal block for rapid installation



# Screw clamp technology - SNK series, terminal blocks

## Features and benefits

### Easy to install

#### Smart design facilitating assembly process.

Mounting, wiring, testing... made easy.

Locking pin **1** allows quick and easy lock up to ten blocks in position at a time.

Closed jumper location allows great stiffness of the terminal block, optimal jumper guiding and avoids deflections while tightening.

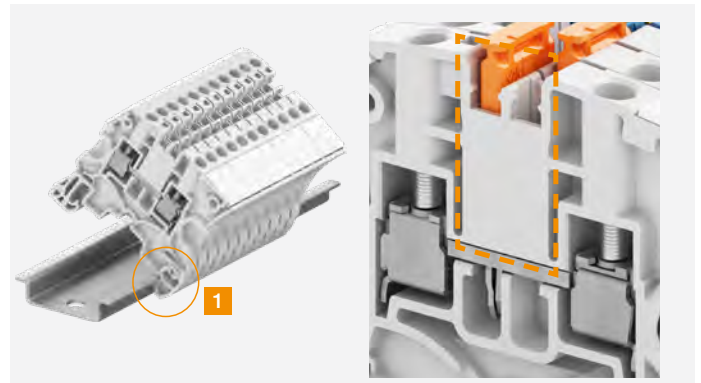

Lock up to ten blocks in position at a time

Closed jumper location for stiffness at a time

### Smart accessories

Flexible test solutions from individual insulated test adapter to test connectors for complete assemblies testing.

- Direct plug-in into jumpers channels
- 5, 6, 8 mm spacing, mixing various spacing is possible
- 1000 V rating.

Component holder plugs for series or parallel component mounting (resistors, filters, diodes..).

Can be installed after wiring.

Series plug offers screwless component connection (no soldering).



Plug-in individual test adapter

Plug-in test connector



Series plug associated with disconnect blocks

Parallel plug to be installed between 2 blocks

### Smart plug-in jumpers:

Pre-cut poles removable by hand: clean cut.

Insulated up to 1000 V (avoid use of separators).

Predefined shapes in molding to easily identify connected poles with a pen.

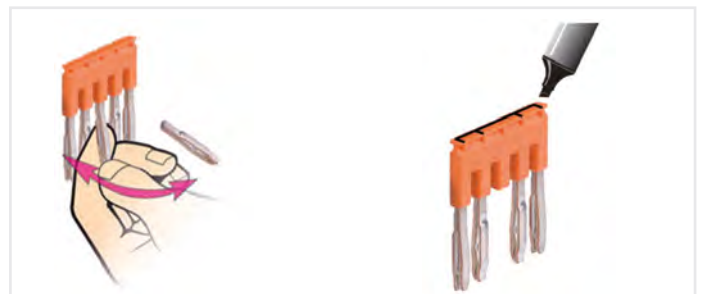

Pre-cut poles easy removable by hand

Predefined shape to identify connected poles

# Screw clamp technology - SNK series, terminal blocks

## Features and benefits

### Optimized logistics

#### Reduce your accessories inventory by up to 50%

SNK PI-Spring, screw and pluggable ranges share the same accessories.

Reduced packaging adapted to the usage (20 items packaging for some references).

All end sections and circuit separators fit several types and sizes of blocks.

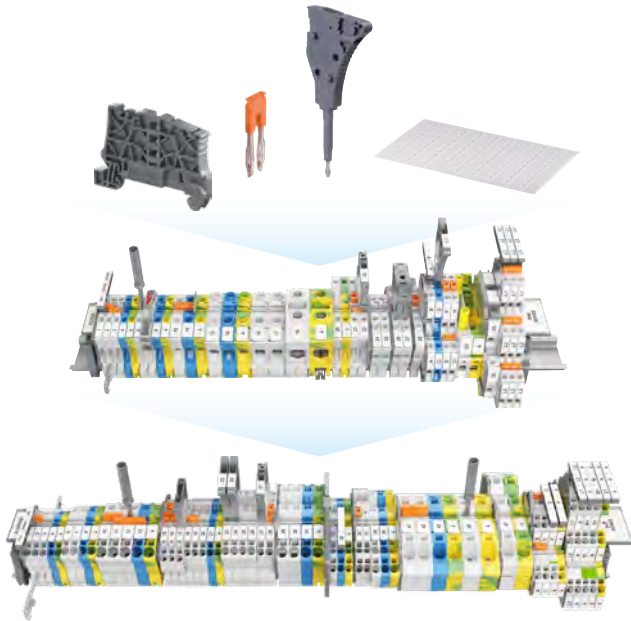

Shared accessories for SNK PI-Spring, screw and pluggable ranges



Stock only one end section for managing your assembly up to 240 mm<sup>2</sup>

### Facilitate maintenance operations

Terminals can be individually removed from a terminal assembly equipped with markers: TE Connectivity markers become independent after strip mounting, TE Connectivity markers remain on terminal in any situation.

### Reliable in harsh conditions

Qualified for worldwide markets, applications and for severe environments: vibration, shock, corrosion...

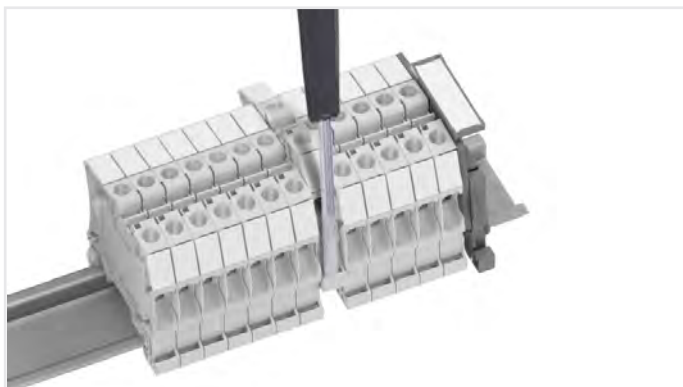

Maintenance operations facilitated



## SNK series, terminal blocks

Screw clamp technology - Range overview from 4 to 240 mm<sup>2</sup> - 10 to 500 Kcmil



2 Connections

### Single deck

Feed-through  
Ground  
Disconnect  
Fuse



3 Connections

### Single deck

Feed-through  
Ground



4 Connections

### Single deck

Feed-through  
Ground  
Disconnect

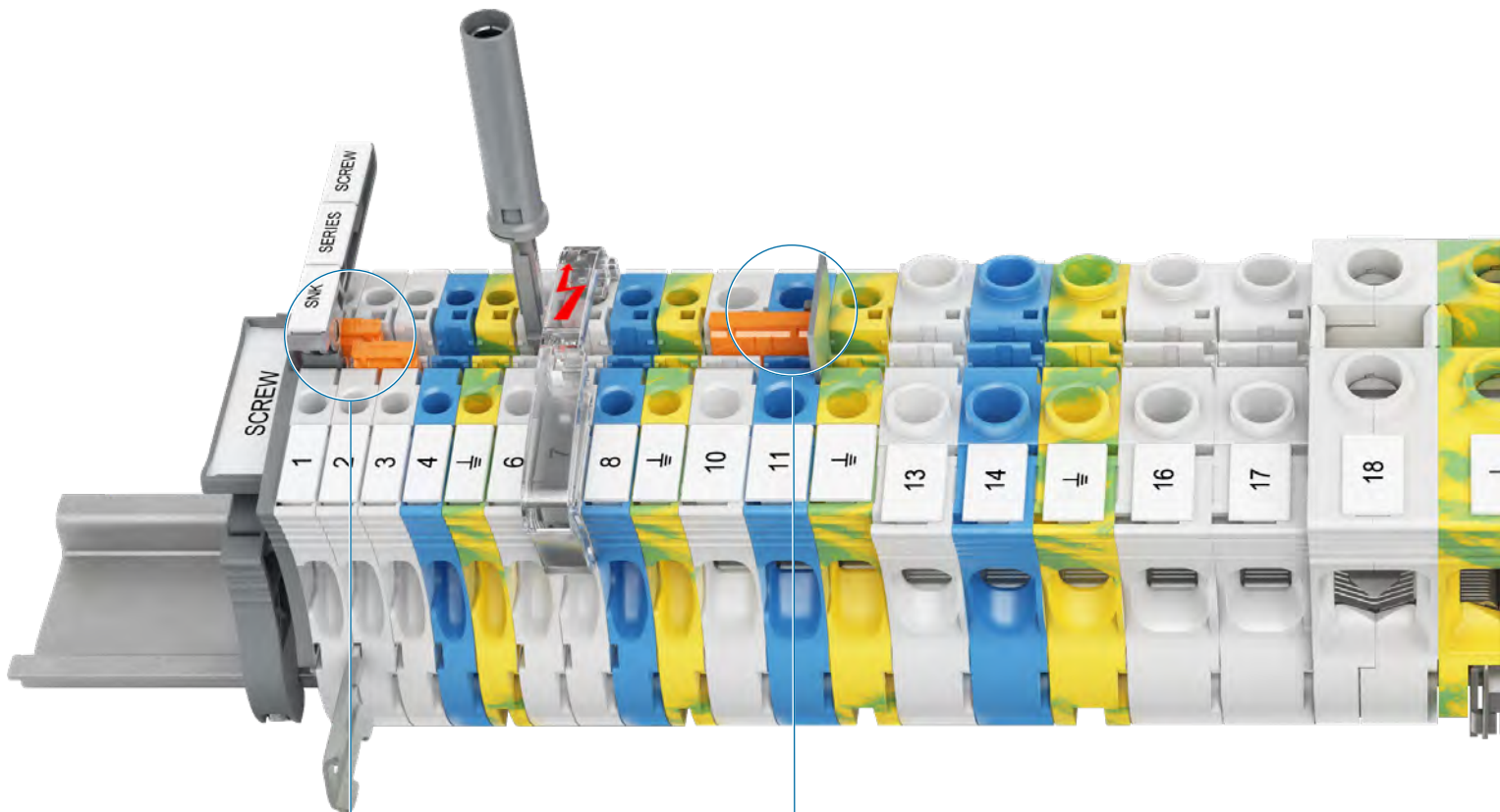

**Double central channels**  
allows multiconfigurations  
(jumping, testing and  
measuring)

**Circuit separator**  
without spacing loss

**2x2**  Connections

- Double deck**
- Feed-through
- Ground
- Disconnect
- Fuse
- Component holder

**2**  Connections

- Test and measurement**
- Feed-through
- Ground
- Disconnect

**3x2**  Connections

- Triple deck**
- Feed-through

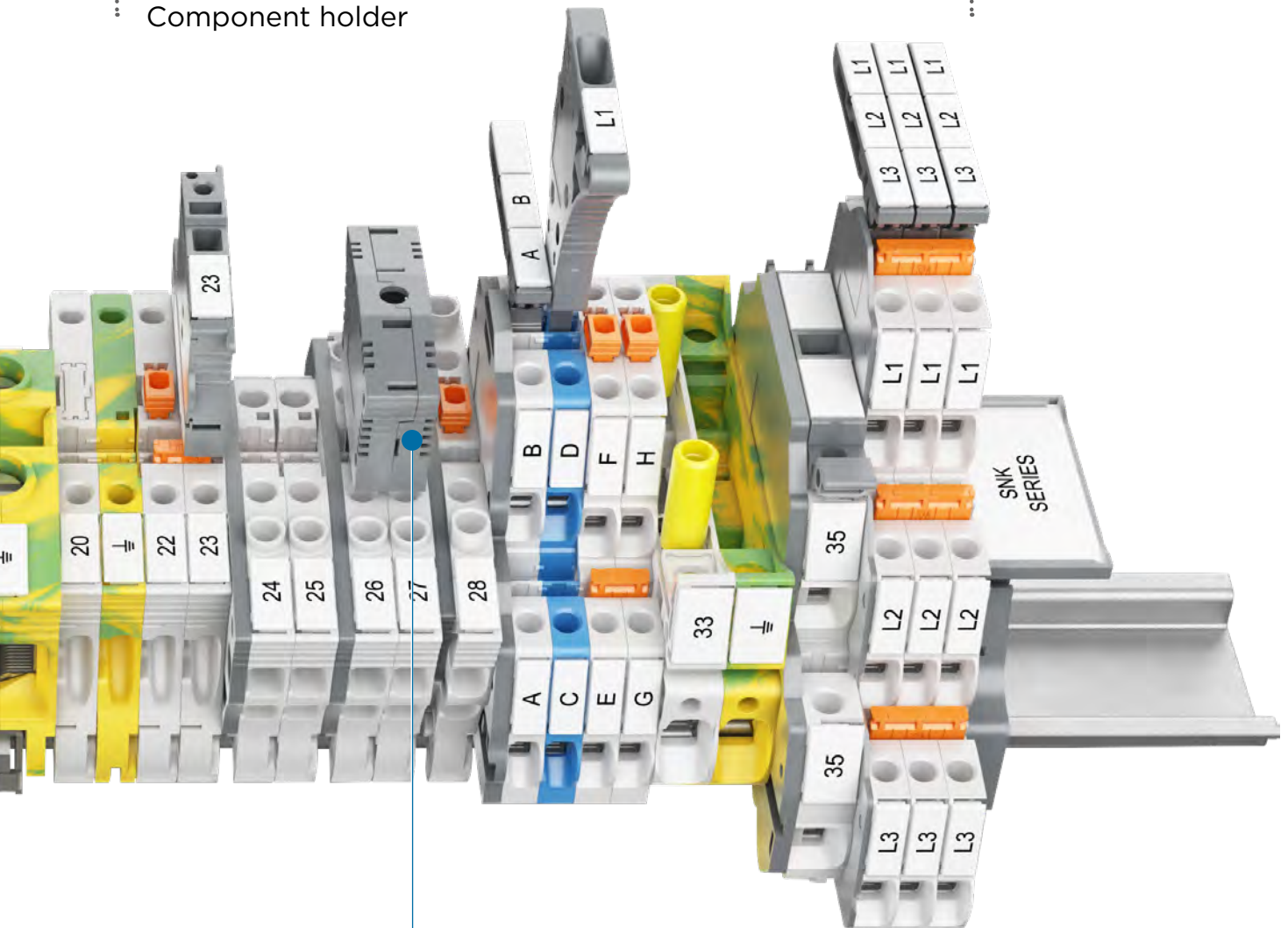

**Plug**  
component holder



# SNK series, terminal blocks

## Screw clamp technology



### Feed-through

### Ground

Section									
4 mm <sup>2</sup>	12 AWG	ZS4					ZS4-PE		
	10 AWG								
6 mm <sup>2</sup>	10 AWG	ZS6	ZS6-3S	ZS6-4S			ZS6-PE	ZS6-3S-PE	ZS6-4S-PE
10 mm <sup>2</sup>	6 AWG	ZS10					ZS10-PE		
16 mm <sup>2</sup>	4 AWG	ZS16					ZS16-PE		
25 mm <sup>2</sup>	3 AWG	ZS25					ZS25-PE		
35 mm <sup>2</sup>	0 AWG				ZS35				ZS35-PE
	2 AWG								
50 mm <sup>2</sup>	0 AWG				ZS50				ZS50-PE
70 mm <sup>2</sup>	00 AWG				ZS70				ZS70-PE
95 mm <sup>2</sup>	0000 AWG				ZS95				ZS95-PE
150 mm <sup>2</sup>	350 Kcmil					ZS150			
240 mm <sup>2</sup>	500 Kcmil					ZS240			



### Disconnect with blade

### Disconnect with plug

Section											
4 mm <sup>2</sup>	10 AWG	ZS4-S	ZS4-S-T2		ZS4-S-R1	ZS4-S-T2-R1	ZS4-S-T2.3-R1	ZS4-SP	ZS4-SP-T2	ZS4-SP-R1	ZS4-SP-T2-R1
6 mm <sup>2</sup>	10 AWG	ZS6-S		ZS6-S-4S-T2							
10 mm <sup>2</sup>	6 AWG	ZS10-S						ZS10-SP			



### For 5 x 20 mm fuses

### Aligned for marshalling cabinets application

### For 6.3 x 32 mm fuses (¼ x 1¼ in)

### Aligned

Section											
4 mm <sup>2</sup>	10 AWG	ZS4-SF	ZS4-SF-T2	ZS4-SF-R1	ZS4-SF-R2	ZS4-R2	ZS4-PE-R2	ZS4-S-R2			
				ZS4-SF-R3	ZS4-SF-R4						
10 mm <sup>2</sup>	6 AWG								ZS10-SF	ZS10-SF-R1	ZS10-S-R2
										ZS10-SF-R3	

Clamp - 
 Channels for jumpering or testing - 
 Test socket - 
 Blown-fuse indicator





# ZS4 screw clamp terminal blocks

## Feed-through - 5.2 mm 0.205 in spacing



1SNK161001E0014

ZS4

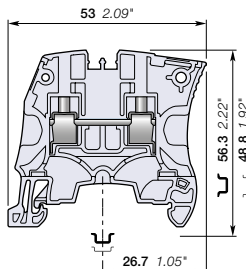

5.2 mm 0.205 in spacing

### Description

- Save space by connecting conductors up to 4 mm<sup>2</sup> (without insulated ferrule, CB certified) 12 AWG in just 5.2 mm 0.205 in spacing,
- Perfectly adapted to solar applications: voltage is rated 1000 V AC / DC IEC.

### Ordering details

Description	Color	Type	Part Number	Pkg qty	Weight (1 pce) g
Feed-through	Grey	ZS4	1SNK505010R0000	50	8.80
	Blue	ZS4-BL	1SNK505020R0000	50	8.80
	Orange	ZS4-OR	1SNK505030R0000	50	8.80
	Yellow	ZS4-YL	1SNK505060R0000	50	8.80
	Green	ZS4-GN	1SNK505061R0000	50	8.80
	Red	ZS4-RD	1SNK505062R0000	50	8.80
	Purple	ZS4-PR	1SNK505063R0000	50	8.80
	Brown	ZS4-BR	1SNK505064R0000	50	8.80
	White	ZS4-WH	1SNK505065R0000	50	8.80
	Black	ZS4-BK	1SNK505066R0000	50	8.80

### Main technical data

Connecting capacity	IEC	UL - CSA	Mounting instructions		
1 conductor per clamp	Rigid: Solid/Stranded	0.2 ... 4 mm <sup>2</sup>	24 ... 12 AWG	Rail	TH 35-7.5, TH 35-15
	Flexible without ferrule	0.22 ... 4 mm <sup>2</sup>	24 ... 12 AWG	Wire stripping length	10.5 mm, 0.412 in
	Flexible with non insulated ferrule	0.22 ... 4 mm <sup>2</sup>	24 ... 12 AWG	Tool	Flat screwdriver Ø 3.5 mm Ø 0.138 in
	Flexible with insulated ferrule	0.22 ... 2.5 mm <sup>2</sup>	24 ... 14 AWG		
	Gauge	A3-B3		Torque	0.6 Nm ± 0.1, 5.31 lb.in ± 0.885
2 conductors per clamp	Rigid: Solid/Stranded	0.2 ... 1.5 mm <sup>2</sup>	24 ... 16 AWG		
	Flexible without ferrule	0.2 ... 1.5 mm <sup>2</sup>	24 ... 16 AWG		
	Flexible with twin ferrule	0.22 ... 1.5 mm <sup>2</sup>	20 A / 12 AWG		
Rated current / Rated cross section		32 A / 4 mm <sup>2</sup>			
Rated short-time withstand current (1s)		480 A			
Short Circuit Current Rating (with specific conditions)			100 kA		
Rated voltage		1000 V	600 V		
Impulse withstand voltage		8000 V			
Protection		IP20	NEMA 1		
Increased safety Ex e		693 V 32 A IEC/EN 60079-7 - IM2 II 2 GD Ex eb I/IIIC - 600 V 20 A UL 60079-7 - Class I, Zone 1, AEx e II, Ex e II U			

The connecting capacity data for one Rigid: Solid/Stranded, or one Flexible conductor (when applicable) is a mandatory information required by IEC, UL and CSA standards (Copper conductors). All other data are provided as supplementary information only. For more details, please consult our CB, UL or CSA certificates and technical datasheet available on <http://www.TE.com>



### Accessories

Description	Color	Type	Part Number	Pkg qty	Weight (1 pce) g	
1 End stops	Dark grey	BAM4	1SNK900001R0000	50	14.00	
2 End sections	Dark grey	ES4	1SNK505910R0000	20	2.20	
3 Jumper bars	Orange	2 poles	JB5-2	1SNK905302R0000	50	1.30
		3 poles	JB5-3	1SNK905303R0000	50	2.00
		4 poles	JB5-4	1SNK905304R0000	50	2.70
		5 poles	JB5-5	1SNK905305R0000	50	3.50
		10 poles	JB5-10	1SNK905310R0000	30	7.10
50 poles	JB5-50	1SNK905350R0000	10	36.00		
4 Cross spacing jumpers	Orange	JB85-3	1SNK900603R0000	10	2.80	
5 Circuit separators	Dark grey	0 mm	CS	1SNK900101R0000	20	0.20
		3 mm	CS-R1	1SNK900103R0000	20	5.20
6 Test adapters	Dark grey	For test plugs DIA 2 mm 0.079 in	TP2	1SNK900203R0000	20	1.70
		For test plugs DIA 4 mm 0.157 in	TP4	1SNK900205R0000	20	2.40
7 Test connectors	Dark grey	5.2 mm 0.205 in spacing	TC5	1SNK900200R0000	10	5.20
		End module, 5.2 mm 0.205 in	TC5-R1	1SNK900201R0000	10	5.20
8 Shield connectors		SHBS	1SNK900600R0000	20	3.50	
9 Protecting covers	Transparent	5.2 mm 0.205 in spacing	PL5	1SNK900618R0000	10	1.50
			MG-CPM 13 41790	1SNB041790R0512	1960	0.23
10 Terminal block markers	White	Blank marker	MC512	1SNK140000R0000	22	9.00
		Blank card	MC512PA	1SNK149999R0000	20	10.00
		Universal wire markers holder	UMH	1SNK900611R0000	10	0.20

Complete list of accessories is indicated in the terminal block datasheet including end stops. Some accessories such as jumper bars may modify the terminal block's ratings: Complete information available in the accessories section of the catalog.

### Ground screw clamp terminal blocks

Description	Color	Type	Part Number	Pkg qty	Weight (1 pce) g
Ground	Green-yellow	ZS4-PE	1SNK505150R0000	20	12.10

Technical data valid for copper conductors only.

# ZS6 screw clamp terminal blocks

## Feed-through - 6 mm 0.236 in spacing

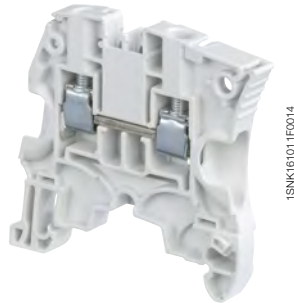
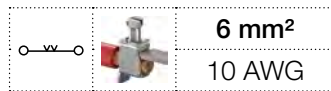

ZS6

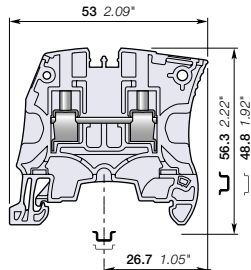

6 mm 0.236 in spacing

### Description

Save space by connecting conductors up to 6 mm<sup>2</sup> (without insulated ferrule, CB certified) 10 AWG in just 6 mm 0.236 in spacing,

– Perfectly adapted to solar applications: voltage is rated 1000 V AC / DC IEC.

### Ordering details

Description	Color	Type	Part Number	Pkg qty	Weight (1 pce) g
Feed-through	Grey	ZS6	1SNK506010R0000	50	10.60
	Blue	ZS6-BL	1SNK506020R0000	50	10.60
	Orange	ZS6-OR	1SNK506030R0000	50	10.60
	Yellow	ZS6-YL	1SNK506060R0000	50	10.60
	Green	ZS6-GN	1SNK506061R0000	50	10.60
	Red	ZS6-RD	1SNK506062R0000	50	10.60
	Purple	ZS6-PR	1SNK506063R0000	50	10.60
	Brown	ZS6-BR	1SNK506064R0000	50	10.60
	White	ZS6-WH	1SNK506065R0000	50	10.60
	Black	ZS6-BK	1SNK506066R0000	50	10.60

### Main technical data

Connecting capacity	IEC	UL - CSA	Rail	Wire stripping length	TH 35-7.5, TH 35-15
1 conductor per clamp	Rigid: Solid/Stranded	0.2 ... 6 mm <sup>2</sup>	24 ... 10 AWG	10.5 mm 0.412 in	Flat screwdriver Ø 4 mm Ø 0.157 in
	Flexible without ferrule	0.2 ... 6 mm <sup>2</sup>	24 ... 12 AWG		
	Flexible with non insulated ferrule	0.22 ... 4 mm <sup>2</sup>	24 ... 12 AWG		
	Flexible with insulated ferrule	0.22 ... 4 mm <sup>2</sup>	24 ... 12 AWG		
	Gauge	A4-B3			
2 conductors per clamp	Rigid: Solid/Stranded	0.2 ... 2.5 mm <sup>2</sup>	24 ... 14 AWG	Torque	0.85 Nm ± 0.15 7.52 lb.in ± 1.33
	Flexible without ferrule	0.2 ... 2.5 mm <sup>2</sup>	24 ... 14 AWG		
	Flexible with twin ferrule	0.22 ... 2.5 mm <sup>2</sup>	24 ... 14 AWG		
Rated current / Rated cross section	41 A / 6 mm <sup>2</sup>	30 A / 10 AWG			
Rated short-time withstand current (1s)	720 A				
Short Circuit Current Rating (with specific conditions)		100 kA			
Rated voltage	1000 V	600 V			
Impulse withstand voltage	8000 V				
Protection	IP20	NEMA 1			

### Increased safety Ex e

693 V 41 A IEC/EN 60079-7 - IM2 II 2 GD Ex eb I/II/III - 600 V 30 A UL 60079-7 - Class I, Zone 1, AEx e II, Ex e II U

The connecting capacity data for one Rigid: Solid/Stranded, or one Flexible conductor (when applicable) is a mandatory information required by IEC, UL and CSA standards (Copper conductors). All other data are provided as supplementary information only. For more details, please consult our CB, UL or CSA certificates and technical datasheet available on <http://www.TE.com>

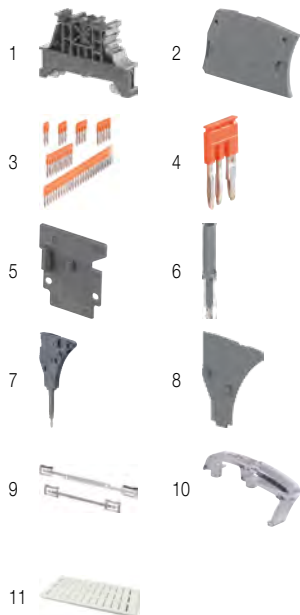

### Accessories

Description	Color	Type	Part Number	Pkg qty	Weight (1 pce) g	
1 End stops	Dark grey	BAM4	1SNK900001R0000	50	14.00	
2 End sections	Dark grey	ES4	1SNK505910R0000	20	2.20	
3 Jumper bars	Orange	2 poles	JB6-2	1SNK906302R0000	50	1.30
		3 poles	JB6-3	1SNK906303R0000	50	2.10
		4 poles	JB6-4	1SNK906304R0000	50	2.90
		5 poles	JB6-5	1SNK906305R0000	50	3.60
		10 poles	JB6-10	1SNK906310R0000	20	7.40
		50 poles	JB6-50	1SNK906350R0000	10	38.10
4 Cross spacing jumpers	Orange	JB85-3	1SNK900603R0000	10	2.80	
5 Circuit separators	Dark grey	0 mm	CS	1SNK900101R0000	20	0.20
		3 mm	CS-R1	1SNK900103R0000	20	5.20
6 Test adapters	Dark grey	For test plugs DIA 2 mm 0.079 in	TP2	1SNK900203R0000	20	1.70
		For test plugs DIA 4 mm 0.157 in	TP4	1SNK900205R0000	20	2.40
7 Test connectors	Dark grey	TC5-R1	1SNK900201R0000	10	5.20	
8 Spacers	Dark grey	ES-TC6	1SNK900105R0000	10	0.80	
9 Shield connectors		SHBS	1SNK900600R0000	20	3.50	
10 Protecting covers	Transparent	PL6	1SNK900619R0000	10	1.80	
11 Terminal block markers	White	Blank marker	MG-CPM 13 41791	1680	0.27	
		Blank card	MC612	1SNK150000R0000	22	10.00
		Universal wire markers holder	UMH	1SNK900611R0000	10	0.20

Complete list of accessories is indicated in the terminal block datasheet including end stops.

Some accessories such as jumper bars may modify the terminal block's ratings: Complete information available in the accessories section of the catalog.

### Ground screw clamp terminal blocks

Description	Color	Type	Part Number	Pkg qty	Weight (1 pce) g
Ground	Green-yellow	ZS6-PE	1SNK506150R0000	20	13.70



Technical data valid for copper conductors only.

# ZS6-3S screw clamp terminal blocks

Feed-through with 3 connections - 6 mm 0.236 in spacing



1SNK1610750014

ZS6-3S

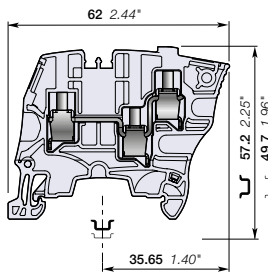

6 mm 0.236 in spacing

## Description

- Recommended for energy markets and highly demanding applications requiring that only one conductor be connected per clamp,
- These blocks offer a high density connecting capacity (up to 3 connections) in a low profile and just 6 mm 0.236 in spacing.

## Ordering details

Description	Color	Type	Part Number	Pkg qty	Weight (1 pce) g
Feed-through	Grey	ZS6-3S	1SNK506011R0000	50	11.80
	Blue	ZS6-3S-BL	1SNK506021R0000	50	11.80
	Yellow	ZS6-3S-YL	1SNK506067R0000	50	11.80

## Main technical data

Connecting capacity		IEC	UL - CSA	Mounting instructions	
1 conductor per clamp	Rigid: Solid/Stranded	0.2 ... 6 mm <sup>2</sup>	24 ... 10 AWG	Rail	TH 35-7.5, TH 35-15
	Flexible without ferrule	0.22 ... 6 mm <sup>2</sup>		Wire stripping length	10.5 mm
	Flexible with non insulated ferrule	0.22 ... 4 mm <sup>2</sup>	24 ... 12 AWG		0.413 in
	Flexible with insulated ferrule	0.22 ... 4 mm <sup>2</sup>	24 ... 12 AWG		
2 conductors per clamp	Gauge	A4-B3		Tool	Flat screwdriver Ø 4 mm Ø 0.157 in
	Rigid: Solid/Stranded	0.2 ... 2.5 mm <sup>2</sup>	24 ... 14 AWG		
	Flexible without ferrule	0.2 ... 2.5 mm <sup>2</sup>			
Rated current / Rated cross section	Flexible with twin ferrule	0.22 ... 2.5 mm <sup>2</sup>	24 ... 14 AWG	Torque	0.75 Nm ± 0.05 6.64 lb.in ± 0.443
		32 A / 4 mm <sup>2</sup>	30 A / 10 AWG		
Maximum current / Maximum cross section		39 A / 6 mm <sup>2</sup>			
Rated short-time withstand current (1s)		480 A			
Short Circuit Current Rating (with specific conditions)			100 kA		
Rated voltage		800 V	600 V		
Impulse withstand voltage		8000 V			
Protection		IP20	NEMA 1		
Increased safety Ex e		550 V 29 A IEC/EN 60079-7 - IM2 II 2 GD Ex eb I/II/III - 600 V 30 A			

The connecting capacity data for one Rigid: Solid/Stranded, or one Flexible conductor (when applicable) is a mandatory information required by IEC, UL and CSA standards (Copper conductors). All other data are provided as supplementary information only. For more details, please consult our CB, UL or CSA certificates and technical datasheet available on <http://www.TE.com>



## Accessories

Description	Color	Type	Part Number	Pkg qty	Weight (1 pce) g	
1 End stops	Dark grey	BAM4	1SNK900001R0000	50	14.00	
2 End sections	Dark grey	ES6-3S	1SNK505912R0000	20	2.50	
3 Jumper bars	Orange	2 poles	JB6-2	1SNK906302R0000	50	1.30
		3 poles	JB6-3	1SNK906303R0000	50	2.10
		4 poles	JB6-4	1SNK906304R0000	50	2.90
		5 poles	JB6-5	1SNK906305R0000	50	3.60
		10 poles	JB6-10	1SNK906310R0000	20	7.40
4 Cross spacing jumpers	Orange	3 poles	JB85-3	1SNK900603R0000	10	2.80
		5 poles	JB85-5	1SNK900605R0000	10	3.80
5 Circuit separators	Dark grey	0 mm	CS	1SNK900101R0000	20	0.20
		3 mm	CS-R1	1SNK900103R0000	20	5.20
6 Test adapters	Dark grey	For test plugs DIA 2 mm 0.079 in	TP2	1SNK900203R0000	20	1.70
		For test plugs DIA 4 mm 0.157 in	TP4	1SNK900205R0000	20	2.40
7 Test connectors	Dark grey	TC5-R1	1SNK900201R0000	10	5.20	
8 Spacers	Dark grey	ES-TC6	1SNK900105R0000	10	0.80	
9 Terminal block markers	White	Blank marker	MG-CPM 13 41791	1SNB041791R0612	1680	0.27
		Blank card	MC612	1SNK150000R0000	22	10.00
			MC612PA	1SNK159999R0000	20	11.00
		Universal wire markers holder	UMH	1SNK900611R0000	10	0.20

Complete list of accessories is indicated in the terminal block datasheet including end stops. Some accessories such as jumper bars may modify the terminal block's ratings: Complete information available in the accessories section of the catalog.

## Ground screw clamp terminal blocks

Description	Color	Type	Part Number	Pkg qty	Weight (1 pce) g
Ground	Green-yellow	ZS6-3S-PE	1SNK506151R0000	25	16.20

Technical data valid for copper conductors only.



# ZS6-4S screw clamp terminal blocks

Feed-through with 4 connections - 6 mm 0.236 in spacing



ZS6-4S

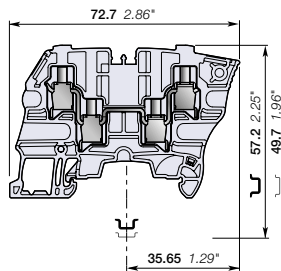

6 mm 0.236 in spacing

## Description

- High density wiring (one potential distribution on 4 independent screw clamps) in a very low profile and just 6 mm 0.236 in spacing,
- Recommended for energy markets and highly demanding applications requiring that only one conductor be connected per clamp.

## Ordering details

Description	Color	Type	Part Number	Pkg qty	Weight (1 pce) g
Feed-through	Grey	ZS6-4S	1SNK506012R0000	50	15.00
	Blue	ZS6-4S-BL	1SNK506022R0000	50	15.00
	Yellow	ZS6-4S-YL	1SNK506068R0000	50	15.00

## Main technical data

Connecting capacity	IEC	UL - CSA	Mounting instructions
1 conductor per clamp	Rigid: Solid/Stranded	0.2 ... 6 mm²	24 ... 10 AWG
	Flexible without ferrule	0.22 ... 6 mm²	
	Flexible with non insulated ferrule	0.22 ... 4 mm²	24 ... 12 AWG
	Flexible with insulated ferrule	0.22 ... 4 mm²	24 ... 12 AWG
	Gauge	A4-B3	
2 conductors per clamp	Rigid: Solid/Stranded	0.2 ... 2.5 mm²	24 ... 14 AWG
	Flexible without ferrule	0.2 ... 2.5 mm²	
	Flexible with twin ferrule	0.22 ... 2.5 mm²	24 ... 14 AWG
Rated current / Rated cross section	32 A / 4 mm²	30 A / 10 AWG	
Maximum current / Maximum cross section	39 A / 6 mm²		
Rated short-time withstand current (1s)	480 A		
Short Circuit Current Rating (with specific conditions)		100 kA	
Rated voltage	800 V	600 V	
Impulse withstand voltage	8000 V		
Protection	IP20	NEMA 1	
Increased safety Ex e	550 V 29 A IEC/EN 60079-7 - IM2 II 2 GD Ex eb I/II/IIIc - 600 V 30 A		

The connecting capacity data for one Rigid: Solid/Stranded, or one Flexible conductor (when applicable) is a mandatory information required by IEC, UL and CSA standards (Copper conductors). All other data are provided as supplementary information only. For more details, please consult our CB, UL or CSA certificates and technical datasheet available on <http://www.TE.com>



## Accessories

Description	Color	Type	Part Number	Pkg qty	Weight (1 pce) g		
1 End stops	Dark grey	BAM4	1SNK900001R0000	50	14.00		
2 End sections	Dark grey	ES6-4S	1SNK505911R0000	20	3.10		
3 Jumper bars	Orange	2 poles	41 A (IEC)	JB6-2	1SNK906302R0000	50	1.30
		3 poles	41 A (IEC)	JB6-3	1SNK906303R0000	50	2.10
		4 poles	41 A (IEC)	JB6-4	1SNK906304R0000	50	2.90
		5 poles	41 A (IEC)	JB6-5	1SNK906305R0000	50	3.60
		10 poles	41 A (IEC)	JB6-10	1SNK906310R0000	20	7.40
		50 poles	41 A (IEC)	JB6-50	1SNK906350R0000	10	38.10
4 Cross spacing jumpers	Orange	3 poles	32 A (IEC)	JB85-3	1SNK900603R0000	10	2.80
5 Circuit separators	Dark grey	0 mm	0 in	CS	1SNK900101R0000	20	0.20
		3 mm	0.118 in	CS-R1	1SNK900103R0000	20	5.20
6 Test adapters	Dark grey	For test plugs DIA 2 mm 0.079 in		TP2	1SNK900203R0000	20	1.70
		For test plugs DIA 4 mm 0.157 in		TP4	1SNK900205R0000	20	2.40
		End module, 5.2 mm 0.205 in		TC5-R1	1SNK900201R0000	10	5.20
8 Spacers	Dark grey	0.8 mm	0.031 in	ES-TC6	1SNK900105R0000	10	0.80
9 Terminal block markers	White	Blank marker		MG-CPM 13 41791	1SNB041791R0612	1680	0.27
		Blank card		MC612	1SNK150000R0000	22	10.00
				MC612PA	1SNK159999R0000	20	11.00
		Universal wire markers holder	Grey	UMH	1SNK900611R0000	10	0.20

Complete list of accessories is indicated in the terminal block datasheet including end stops. Some accessories such as jumper bars may modify the terminal block's ratings: Complete information available in the accessories section of the catalog.

## Ground screw clamp terminal blocks

Description	Color	Type	Part Number	Pkg qty	Weight (1 pce) g
Ground	Green-yellow	ZS6-4S-PE	1SNK506152R0000	25	19.40

Technical data valid for copper conductors only.



# ZS10 screw clamp terminal blocks

## Feed-through - 8 mm 0.315 in spacing

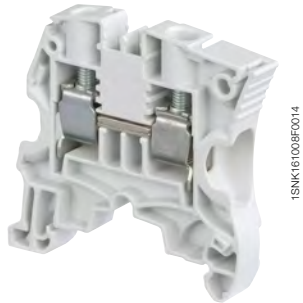

ZS10

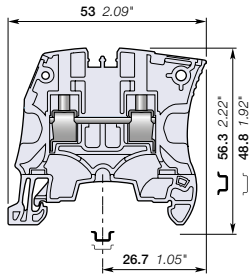

8 mm 0.315 in spacing

### Description

- Save space by connecting conductors up to 10 mm<sup>2</sup> (without insulated ferrule, CB certified) 6 AWG in just 8 mm 0.315 in spacing,
- Perfectly adapted to solar applications: voltage is rated 1000 V AC / DC IEC.

### Ordering details

Description	Color	Type	Part Number	Pkg qty	Weight (1 pce) g
Feed-through	Grey	ZS10	1SNK508010R0000	50	14.10
	Blue	ZS10-BL	1SNK508020R0000	50	14.10
	Orange	ZS10-OR	1SNK508030R0000	50	14.10
	Yellow	ZS10-YL	1SNK508060R0000	50	14.10
	Green	ZS10-GN	1SNK508061R0000	50	14.10
	Red	ZS10-RD	1SNK508062R0000	50	14.10
	Purple	ZS10-PR	1SNK508063R0000	50	14.10
	Brown	ZS10-BR	1SNK508064R0000	50	14.10
	White	ZS10-WH	1SNK508065R0000	50	14.10
	Black	ZS10-BK	1SNK508066R0000	50	14.10

### Main technical data

Connecting capacity		IEC	UL - CSA	Mounting instructions	
1 conductor per clamp	Rigid: Solid/Stranded	0.5 ... 10 mm <sup>2</sup>	24 ... 6 AWG	Rail	TH 35-7.5, TH 35-15
	Flexible without ferrule	0.5 ... 10 mm <sup>2</sup>		Wire stripping length	12 mm 0.472 in
	Flexible with non insulated ferrule	0.5 ... 10 mm <sup>2</sup>	24 ... 8 AWG	Tool	Flat screwdriver Ø 4 mm Ø 0.157 in
	Flexible with insulated ferrule	0.5 ... 6 mm <sup>2</sup>	24 ... 10 AWG		
	Gauge	A5-B5		Torque	1.3 Nm ± 0.3 11.5 lb.in ± 2.65
2 conductors per clamp	Rigid: Solid/Stranded	0.5 ... 4 mm <sup>2</sup>	20 ... 12 AWG		
	Flexible without ferrule	0.5 ... 4 mm <sup>2</sup>			
	Flexible with twin ferrule	0.5 ... 4 mm <sup>2</sup>	20 ... 12 AWG		
Rated current / Rated cross section		57 A / 10 mm <sup>2</sup>	42 A / 6 AWG		
Rated short-time withstand current (1s)		1200 A			
Short Circuit Current Rating (with specific conditions)			100 kA		
Rated voltage		1000 V	600 V		
Impulse withstand voltage		8000 V			
Protection		IP20	NEMA 1		

**Increased safety Ex e** 693 V 57 A IEC/EN 60079-7 - IM2 II 2 GD Ex eb III/IIIC - 600 V 42 A UL 60079-7 - Class I, Zone 1, AEx e II, Ex e II U

The connecting capacity data for one Rigid: Solid/Stranded, or one Flexible conductor (when applicable) is a mandatory information required by IEC, UL and CSA standards (Copper conductors). All other data are provided as supplementary information only. For more details, please consult our CB, UL or CSA certificates and technical datasheet available on <http://www.TE.com>



### Accessories

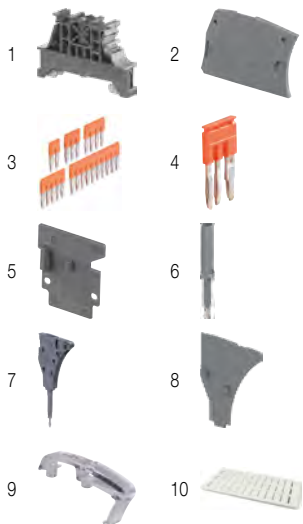

Description	Color	Type	Part Number	Pkg qty	Weight (1 pce) g	
1 End stops	Dark grey	BAM4	1SNK900001R0000	50	14.00	
2 End sections	Dark grey	ES4	1SNK505910R0000	20	2.20	
3 Jumper bars	Orange	2 poles 57 A (IEC)	JB8-2	1SNK908302R0000	50	2.70
		3 poles 57 A (IEC)	JB8-3	1SNK908303R0000	50	4.10
		4 poles 57 A (IEC)	JB8-4	1SNK908304R0000	50	5.60
		5 poles 57 A (IEC)	JB8-5	1SNK908305R0000	40	7.00
		10 poles 57 A (IEC)	JB8-10	1SNK908310R0000	20	14.20
4 Cross spacing jumpers	Orange	JB85-3	1SNK900603R0000	10	2.80	
5 Circuit separators	Dark grey	0 mm 0 in	CS	1SNK900101R0000	20	0.20
		3 mm 0.118 in	CS-R1	1SNK900103R0000	20	5.20
6 Test adapters	Dark grey	For test plugs DIA 2 mm 0.079 in	TP2	1SNK900203R0000	20	1.70
		For test plugs DIA 4 mm 0.157 in	TP4	1SNK900205R0000	20	2.40
7 Test connectors	Dark grey	5.2 mm 0.205 in spacing	TC5	1SNK900200R0000	10	5.20
		End module, 5.2 mm 0.205 in	TC5-R1	1SNK900201R0000	10	5.20
8 Spacers	Dark grey	ES-TC8	1SNK900104R0000	10	1.40	
9 Protecting covers	Transparent	PL8	1SNK900620R0000	10	2.60	
10 Terminal block markers	White	Blank marker	MG-CPM 13 41791	1SNB041791R0612	1680	0.27
		Blank card	MC812	1SNK160000R0000	22	10.00
			MC812PA	1SNK169999R0000	20	14.00
		Universal wire markers holder	Grey	UMH	1SNK900611R0000	10

Complete list of accessories is indicated in the terminal block datasheet including end stops.

Some accessories such as jumper bars may modify the terminal block's ratings: Complete information available in the accessories section of the catalog.

### Ground screw clamp terminal blocks

Description	Color	Type	Part Number	Pkg qty	Weight (1 pce) g
Ground	Green-yellow	ZS10-PE	1SNK508150R0000	20	22.50

Technical data valid for copper conductors only.

# ZS16 screw clamp terminal blocks

## Feed-through - 10 mm 0.394 in spacing

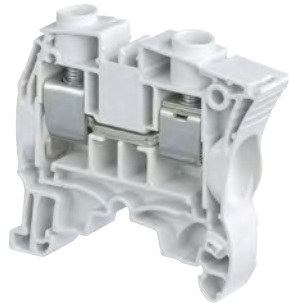
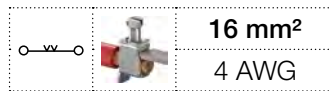

ZS16

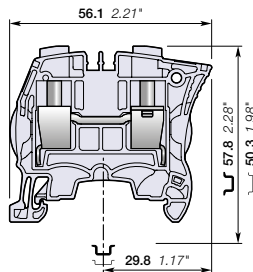

10 mm 0.394 in spacing

### Description

- Save space by connecting conductors up to 16 mm<sup>2</sup> (without insulated ferrule, CB certified) 4 AWG in just 10 mm 0.394 in spacing,
- Perfectly adapted to solar applications: voltage is rated 1000 V AC / DC IEC.

### Ordering details

Description	Color	Type	Part Number	Pkg qty	Weight (1 pce) g
Feed-through	Grey <input type="checkbox"/>	ZS16	1SNK510010R0000	25	20.20
	Blue <input type="checkbox"/>	ZS16-BL	1SNK510020R0000	25	20.20
	Orange <input type="checkbox"/>	ZS16-OR	1SNK510030R0000	25	20.20

### Main technical data

Connecting capacity		IEC	UL - CSA	Mounting instructions	
1 conductor per clamp	Rigid: Solid/Stranded	0.5 ... 16 mm <sup>2</sup>	24 ... 4 AWG	Rail	TH 35-7.5, TH 35-15
	Flexible without ferrule	0.5 ... 16 mm <sup>2</sup>		Wire stripping length	13.5 mm 0.531 in
	Flexible with non insulated ferrule	0.5 ... 16 mm <sup>2</sup>	24 ... 4 AWG		
	Flexible with insulated ferrule	0.5 ... 10 mm <sup>2</sup>	24 ... 8 AWG		
	Gauge	A6-B6			
2 conductors per clamp	Rigid: Solid/Stranded	0.5 ... 6 mm <sup>2</sup>	20 ... 10 AWG	Tool	Flat screwdriver Ø 5.5 mm Ø 0.217 in
	Flexible without ferrule	0.5 ... 6 mm <sup>2</sup>	20 ... 10 AWG		
	Flexible with twin ferrule	0.5 ... 6 mm <sup>2</sup>	20 ... 10 AWG		
Rated current / Rated cross section		76 A / 16 mm <sup>2</sup>	67 A / 4 AWG	Torque	1.8 Nm ± 0.2 15.9 lb.in ± 1.77
Rated short-time withstand current (1s)		1920 A			
Short Circuit Current Rating (with specific conditions)			100 kA		
Rated voltage		1000 V	600 V		
Impulse withstand voltage		8000 V			
Protection		IP20	NEMA 1		
Increased safety Ex e		693 V 76 A IEC/EN 60079-7 - IM2 II 2 GD Ex eb I/IIIC - 600 V 67 A UL 60079-7 - Class I, Zone 1, AEx e II, Ex e II U			

The connecting capacity data for one Rigid: Solid/Stranded, or one Flexible conductor (when applicable) is a mandatory information required by IEC, UL and CSA standards (Copper conductors). All other data are provided as supplementary information only. For more details, please consult our CB, UL or CSA certificates and technical datasheet available on <http://www.TE.com>



### Accessories

Description	Color	Type	Part Number	Pkg qty	Weight (1 pce) g	
1 End stops	Dark grey <input type="checkbox"/>	BAM4	1SNK900001R0000	50	14.00	
2 End sections	Dark grey <input type="checkbox"/>	ES4	1SNK505910R0000	20	2.20	
3 Jumper bars	Orange <input type="checkbox"/>	2 poles	JB10-2	1SNK910302R0000	50	4.60
		3 poles	JB10-3	1SNK910303R0000	50	7.10
		4 poles	JB10-4	1SNK910304R0000	40	9.40
		5 poles	JB10-5	1SNK910305R0000	30	12.00
		10 poles	JB10-10	1SNK910310R0000	20	24.00
4 Cross spacing jumpers	Orange <input type="checkbox"/>	JB85-3	1SNK900603R0000	10	2.80	
5 Circuit separators	Dark grey <input type="checkbox"/>	0 mm	CS	1SNK900101R0000	20	0.20
		3 mm	CS-R1	1SNK900103R0000	20	5.20
6 Test adapters	Dark grey <input type="checkbox"/>	For test plugs DIA 2 mm 0.079 in	TP2	1SNK900203R0000	20	1.70
		For test plugs DIA 4 mm 0.157 in	TP4	1SNK900205R0000	20	2.40
7 Protecting covers	Transparent <input type="checkbox"/>	PL10	1SNK900621R0000	10	3.10	
8 Terminal block markers	White <input type="checkbox"/>	Blank marker	MG-CPM 13 41791	1SNB041791R0612	1680	0.27
		Blank card	MC812	1SNK160000R0000	22	10.00
			MC812PA	1SNK169999R0000	20	14.00
		Universal wire markers holder	Grey <input type="checkbox"/>	UMH	1SNK900611R0000	10

Complete list of accessories is indicated in the terminal block datasheet including end stops. Some accessories such as jumper bars may modify the terminal block's ratings: Complete information available in the accessories section of the catalog.

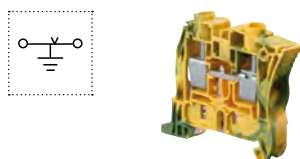

### Ground screw clamp terminal blocks

Description	Color	Type	Part Number	Pkg qty	Weight (1 pce) g
Ground	Green-yellow <input type="checkbox"/>	ZS16-PE	1SNK510150R0000	20	32.00

Technical data valid for copper conductors only.

# ZS25 screw clamp terminal blocks

## Feed-through - 12 mm 0.472 in spacing

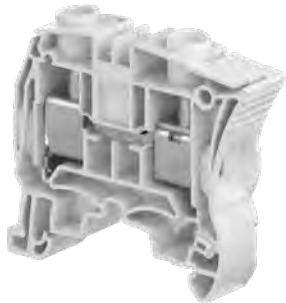

ZS25

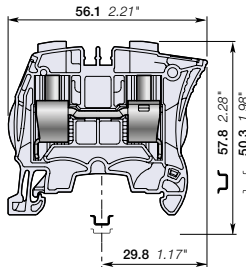

12 mm 0.472 in spacing

### Description

- Save space by connecting conductors up to 25 mm<sup>2</sup> (without insulated ferrule, CB certified) 3 AWG in just 12 mm 0.472 in spacing,
- Perfectly adapted to solar applications: voltage is rated 1000 V AC / DC IEC.

### Ordering details

Description	Color	Type	Part Number	Pkg qty	Weight (1 pce) g
Feed-through	Grey <input type="checkbox"/>	ZS25	1SNK512010R0000	25	21.40
	Blue <input type="checkbox"/>	ZS25-BL	1SNK512020R0000	25	21.40
	Yellow <input type="checkbox"/>	ZS25-YL	1SNK512060R0000	25	21.40

### Main technical data

Connecting capacity		IEC	UL - CSA	Mounting instructions	
1 conductor per clamp	Rigid: Solid/Stranded	0.5 ... 25 mm <sup>2</sup>	24 ... 3 AWG	Rail	TH 35-7.5, TH 35-15
	Flexible without ferrule	0.5 ... 25 mm <sup>2</sup>		Wire stripping length	13.5 mm 0.531 in
	Flexible with non insulated ferrule	0.5 ... 16 mm <sup>2</sup>	24 ... 4 AWG		
	Flexible with insulated ferrule	0.5 ... 16 mm <sup>2</sup>	24 ... 8 AWG		
	Gauge	A6-B6			
2 conductors per clamp	Rigid: Solid/Stranded	0.5 ... 10 mm <sup>2</sup>	20 ... 10 AWG	Tool	Flat screwdriver Ø 5.5 mm Ø 0.217 in
	Flexible without ferrule	0.5 ... 10 mm <sup>2</sup>	20 ... 10 AWG		
	Flexible with twin ferrule	0.5 ... 10 mm <sup>2</sup>	20 ... 10 AWG		
Rated current / Rated cross section		76 A / 16 mm <sup>2</sup>	100 A / 3 AWG	Torque	1.8 Nm ± 0.2 15.9 lb.in ± 1.77
Maximum current / Maximum cross section		101 A / 25 mm <sup>2</sup>			
Rated short-time withstand current (1s)		1920 A			
Short Circuit Current Rating (with specific conditions)			100 kA		
Rated voltage		1000 V	600 V		
Impulse withstand voltage		8000 V			
Protection		IP20	NEMA 1		
Increased safety Ex e		693 V 69 A IEC/EN 60079-7 - IM2 II 2 GD Ex eb I/II/MIC - 600 V 100 A			

The connecting capacity data for one Rigid: Solid/Stranded, or one Flexible conductor (when applicable) is a mandatory information required by IEC, UL and CSA standards (Copper conductors). All other data are provided as supplementary information only. For more details, please consult our CB, UL or CSA certificates and technical datasheet available on <http://www.TE.com>



### Accessories

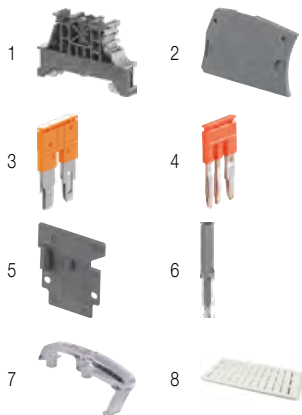

Description	Color	Type	Part Number	Pkg qty	Weight (1 pce) g
1 End stops 10 mm 0.394 in	Dark grey <input type="checkbox"/>	BAM4	1SNK900001R0000	50	14.00
2 End sections 2.2 mm 0.087 in	Dark grey <input type="checkbox"/>	ES4	1SNK505910R0000	20	2.20
3 Jumper bars 2 poles 76 A (IEC)	Orange <input type="checkbox"/>	JB12-2	1SNK912302R0000	50	4.90
		JB12-3	1SNK912303R0000	50	7.60
		JB12-5	1SNK912305R0000	20	12.90
4 Cross spacing jumpers 3 poles 32 A (IEC)	Orange <input type="checkbox"/>	JB85-3	1SNK900603R0000	10	2.80
5 Circuit separators 0 mm 0 in	Dark grey <input type="checkbox"/>	CS	1SNK900101R0000	20	0.20
		CS-R1	1SNK900103R0000	20	5.20
6 Test adapters For test plugs DIA 2 mm 0.079 in	Dark grey <input type="checkbox"/>	TP2	1SNK900203R0000	20	1.70
		TP4	1SNK900205R0000	20	2.40
7 Protecting covers 10 mm 0.394 in spacing	Transparent <input type="checkbox"/>	PL10	1SNK900621R0000	10	3.10
8 Terminal block markers	White <input type="checkbox"/>	MG-CPM 13 41791	1SNB041791R0612	1680	0.27
		MC812	1SNK160000R0000	22	10.00
		MC812PA	1SNK169999R0000	20	14.00
		Universal wire markers holder	Grey <input type="checkbox"/>	UMH	1SNK900611R0000

Complete list of accessories is indicated in the terminal block datasheet including end stops. Some accessories such as jumper bars may modify the terminal block's ratings: Complete information available in the accessories section of the catalog.

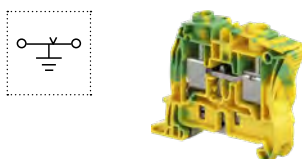

### Ground screw clamp terminal blocks

Description	Color	Type	Part Number	Pkg qty	Weight (1 pce) g
Ground Profile aligned with ZS25	Green-yellow <input type="checkbox"/>	ZS25-PE	1SNK512150R0000	20	38.00

Technical data valid for copper conductors only.

# ZS35 screw clamp terminal blocks

## Feed-through - 16 mm 0.630 in spacing



ZS35

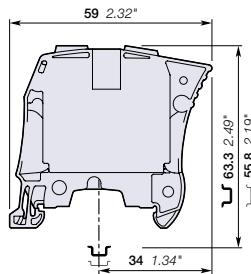

16 mm 0.630 in spacing

### Description

Closed terminal block:

- No end section needed,
- Optimized rigidity,
- Perfectly adapted to solar applications: voltage is rated 1000 V AC / DC IEC.

### Ordering details

Description	Color	Type	Part Number	Pkg qty	Weight (1 pce) g
Feed-through Closed block	Grey <input type="checkbox"/>	ZS35	1SNK516010R0000	20	53.40
	Blue <input type="checkbox"/>	ZS35-BL	1SNK516020R0000	20	53.40
	Orange <input type="checkbox"/>	ZS35-OR	1SNK516030R0000	20	53.40

### Main technical data

Connecting capacity		IEC	UL - CSA	Mounting instructions	
1 conductor per clamp	Rigid: Solid/Stranded	6 ... 35 mm <sup>2</sup>	10 ... 0 AWG	Rail	TH 35-7.5, TH 35-15
	Flexible without ferrule	6 ... 35 mm <sup>2</sup>		Wire stripping length	17 mm 0.669 in
	Flexible with non insulated ferrule	4 ... 35 mm <sup>2</sup>	10 ... 2 AWG		
	Flexible with insulated ferrule	4 ... 35 mm <sup>2</sup>	10 ... 2 AWG		
	Gauge	A9-B9			
2 conductors per clamp	Rigid: Solid/Stranded	6 ... 16 mm <sup>2</sup>	10 ... 6 AWG	Tool	Flat screwdriver Ø 6.5 mm Ø 0.256 in
	Flexible without ferrule	6 ... 16 mm <sup>2</sup>			
	Flexible with twin ferrule	4 ... 10 mm <sup>2</sup>	12 ... 8 AWG		
Rated current / Rated cross section		125 A / 35 mm <sup>2</sup>	150 A / 0 AWG	Torque	2.9 Nm ± 0.1 25.7 lb.in ± 0.885
Rated short-time withstand current (1s)		4200 A			
Short Circuit Current Rating (with specific conditions)			100 kA		
Rated voltage		1000 V	600 V		
Impulse withstand voltage		8000 V			
Protection		IP10	NEMA 1		
Increased safety Ex e		693 V 125 A IEC/EN 60079-7 - IM2 II 2 GD Ex eb I/II/III - 600 V 150 A UL 60079-7 - Class I, Zone 1, AEx e II			

The connecting capacity data for one Rigid: Solid/Stranded, or one Flexible conductor (when applicable) is a mandatory information required by IEC, UL and CSA standards (Copper conductors). All other data are provided as supplementary information only. For more details, please consult our CB, UL or CSA certificates and technical datasheet available on <http://www.TE.com>



### Accessories

Description	Color	Type	Part Number	Pkg qty	Weight (1 pce) g	
1 End stops	Dark grey <input type="checkbox"/>	BAZH1	1SNK900102R0000	20	24.00	
2 Jumper bars	Orange <input type="checkbox"/>	2 poles	JB16-2	1SNK916302R0000	10	10.00
		3 poles	JB16-3	1SNK916303R0000	10	16.00
		4 poles	JB16-4	1SNK916304R0000	10	22.00
		5 poles	JB16-5	1SNK916305R0000	10	28.00
		10 poles	JB16-10	1SNK916310R0000	10	56.60
3 Circuit separators	Dark grey <input type="checkbox"/>	CS-R1	1SNK900103R0000	20	5.20	
4 Protecting covers	Transparent <input type="checkbox"/>	PL16	1SNK900622R0000	10	4.60	
5 Terminal block markers	White <input type="checkbox"/>	Blank marker	MG-CPM 13 41791	1SNB041791R0612	1680	0.27
		Blank card	MC812	1SNK160000R0000	22	10.00
		Universal wire markers holder	Grey <input type="checkbox"/>	UMH	1SNK900611R0000	20

Complete list of accessories is indicated in the terminal block datasheet including end stops.

Some accessories such as jumper bars may modify the terminal block's ratings: Complete information available in the accessories section of the catalog.

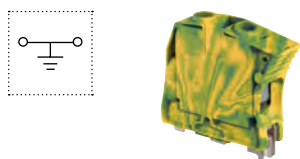

### Ground screw clamp terminal blocks

Description	Color	Type	Part Number	Pkg qty	Weight (1 pce) g
Ground	Green-yellow <input type="checkbox"/>	ZS35-PE	1SNK516150R0000	20	81.80

Technical data valid for copper conductors only.



# ZS50 screw clamp terminal blocks

## Feed-through - 16 mm 0.630 in spacing



1SNK161084V0014

ZS50

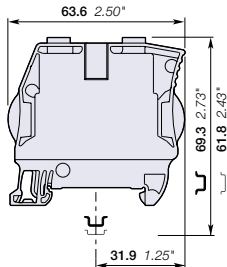

16 mm 0.630 in spacing

### Description

Combine high performance with compact dimensions:

- Connect conductors up to 50 mm<sup>2</sup> (CB certified) 0 AWG in just 16 mm 0.630 in spacing,
- Perfectly adapted to solar applications: 1250 V DC (1000 V AC) IEC and 1000 V UL,
- Closed terminal block: no end section needed, optimized rigidity.

### Ordering details

Description	Color	Type	Part Number	Pkg qty	Weight (1 pce) <b>g</b>
Feed-through Closed block	Grey	ZS50	1SNK516011R0000	20	52.90
	Blue	ZS50-BL	1SNK516021R0000	20	52.90
	Yellow	ZS50-YL	1SNK516060R0000	20	52.90
	Red	ZS50-RD	1SNK516063R0000	20	52.90
	Black	ZS50-BK	1SNK516064R0000	20	52.90

### Main technical data

Connecting capacity		IEC	UL - CSA	Rail		TH 35-7.5, TH 35-15
1 conductor per clamp	Rigid: Solid/Stranded	1 ... 50 mm <sup>2</sup>	18 ... 0 AWG	Wire stripping length		17 mm 0.669 in
	Flexible without ferrule	1 ... 50 mm <sup>2</sup>	18 ... 0 AWG			
	Flexible with non insulated ferrule	1 ... 50 mm <sup>2</sup>	18 ... 0 AWG			
	Flexible with insulated ferrule	1 ... 50 mm <sup>2</sup>	18 ... 0 AWG			
	Gauge	Dia. 11				
2 conductors per clamp	Rigid: Solid/Stranded	1 ... 25 mm <sup>2</sup>	18 ... 4 AWG	Tool		Flat screwdriver Ø 6.5 mm Ø 0.256 in
	Flexible without ferrule	1 ... 25 mm <sup>2</sup>	18 ... 4 AWG			
	Flexible with twin ferrule	1 ... 16 mm <sup>2</sup>	18 ... 4 AWG			
Rated current / Rated cross section		150 A / 50 mm <sup>2</sup>	140 A / 0 AWG	Torque		3 Nm ± 0.50 26.6 lb.in ± 4.43
Rated short-time withstand current (1s)		6000 A				
Short Circuit Current Rating (with specific conditions)			100 kA			
Rated voltage		1000 V	1000 V			
Impulse withstand voltage		8000 V				
Protection		IP10	NEMA 1			
Increased safety Ex e		880 V 150 A IEC/EN 60079-7 - IM2 II 2 GD Ex eb I/IIIC				

The connecting capacity data for one Rigid: Solid/Stranded, or one Flexible conductor (when applicable) is a mandatory information required by IEC, UL and CSA standards (Copper conductors). All other data are provided as supplementary information only. For more details, please consult our CB, UL or CSA certificates and technical datasheet available on <http://www.TE.com>



### Accessories

Description	Color	Type	Part Number	Pkg qty	Weight (1 pce) <b>g</b>	
1 End stops	Dark grey	BAZH1	1SNK900102R0000	20	24.00	
2 Jumper bars	Orange	2 poles 125 A (IEC)	JB16-2	1SNK916302R0000	10	10.00
		3 poles 125 A (IEC)	JB16-3	1SNK916303R0000	10	16.00
		4 poles 125 A (IEC)	JB16-4	1SNK916304R0000	10	22.00
		5 poles 125 A (IEC)	JB16-5	1SNK916305R0000	10	28.00
		10 poles 125 A (IEC)	JB16-10	1SNK916310R0000	10	56.60
		3 Terminal block markers	White	Blank marker	MG-CPM 13 41791	1SNB041791R0612
Blank card	MC812			1SNK160000R0000	22	10.00
	MC812PA			1SNK169999R0000	20	14.00
Universal wire markers holder	Grey		UMH	1SNK900611R0000	10	0.20

Complete list of accessories is indicated in the terminal block datasheet including end stops.

Some accessories such as jumper bars may modify the terminal block's ratings: Complete information available in the accessories section of the catalog.

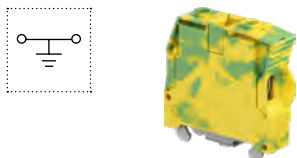

### Ground screw clamp terminal blocks

Description	Color	Type	Part Number	Pkg qty	Weight (1 pce) <b>g</b>
Ground Profile aligned with ZS50	Green-yellow	ZS50-PE	1SNK516151R0000	20	83.00

Technical data valid for copper conductors only.



# ZS70 screw clamp terminal blocks

## Feed-through - 22 mm 0.866 in spacing

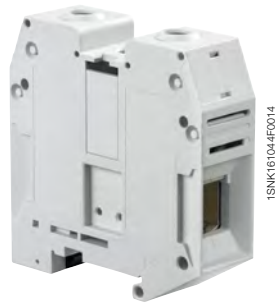

ZS70

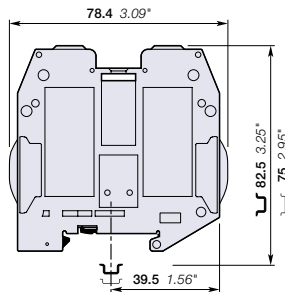

22 mm 0.866 in spacing

### Description

Closed terminal block:

- No end section needed,
- Optimized rigidity,
- Perfectly adapted to solar applications: 1250 V DC (1000 V AC) IEC and 1000 V UL.

### Ordering details

Description	Color	Type	Part Number	Pkg qty	Weight (1 pce) g
Feed-through Closed block	Grey	ZS70	1SNK522010R0000	10	158.10
	Blue	ZS70-BL	1SNK522020R0000	10	158.10
	Yellow	ZS70-YL	1SNK522060R0000	10	158.10

### Main technical data

Connecting capacity		IEC	UL - CSA	Mounting instructions	
1 conductor per clamp	Rigid: Solid/Stranded	16 ... 95 mm <sup>2</sup>	4 ... 00 AWG	Rail	TH 35-7.5, TH 35-15
	Flexible without ferrule	16 ... 70 mm <sup>2</sup>		Wire stripping length	25 mm 0.984 in
	Flexible with non insulated ferrule	16 ... 50 mm <sup>2</sup>			
	Flexible with insulated ferrule	16 ... 50 mm <sup>2</sup>			
	Gauge	B11			
2 conductors per clamp	Rigid: Solid/Stranded	16 ... 35 mm <sup>2</sup>	4 ... 2 AWG	Tool	Allen key Ø 6 mm Ø 0.236 in
	Flexible without ferrule	16 ... 35 mm <sup>2</sup>			
	Flexible with twin ferrule	16 mm <sup>2</sup>	6 AWG		
Rated current / Rated cross section		192 A / 70 mm <sup>2</sup>	159 A / 00 AWG	Torque	6.5 Nm ± 0.5 57.5 lb.in ± 4.43
Rated short-time withstand current (1s)		8400 A			
Short Circuit Current Rating (with specific conditions)			100 kA		
Rated voltage		1000 V	1000 V		
Impulse withstand voltage		8000 V			
Protection		IP10	NEMA 1		

Increased safety Ex e 693 V 192 A IEC/EN 60079-7 - IM2 II 2 GD Ex eb I/II/III - 600 V 159 A UL 60079-7 - Class I, Zone 1, AEx e II, Ex e II U

The connecting capacity data for one Rigid: Solid/Stranded, or one Flexible conductor (when applicable) is a mandatory information required by IEC, UL and CSA standards (Copper conductors). All other data are provided as supplementary information only. For more details, please consult our CB, UL or CSA certificates and technical datasheet available on <http://www.TE.com>



### Accessories

Description	Color	Type	Part Number	Pkg qty	Weight (1 pce) g	
1 End stops	Dark grey	BAZH1	1SNK900102R0000	20	24.00	
2 Jumper bars		2 poles	JB22-2	1SNK922302R0000	5	27.00
		3 poles	JB22-3	1SNK922303R0000	5	43.30
		5 poles	JB22-5	1SNK922305R0000	5	76.10
		10 poles	JB22-10	1SNK922310R0000	5	157.40
		Blank marker	White	MG-CPM 13 41791	1SNB041791R0612	1680
3 Terminal block markers		Blank card	MC812	1SNK160000R0000	22	10.00
			MC812PA	1SNK169999R0000	20	14.00
		Universal wire markers holder	Grey	UMH	1SNK900611R0000	10

Complete list of accessories is indicated in the terminal block datasheet including end stops.

Some accessories such as jumper bars may modify the terminal block's ratings: Complete information available in the accessories section of the catalog.

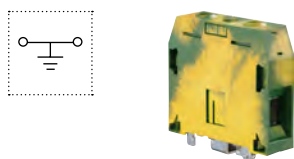

### Ground screw clamp terminal blocks

Description	Color	Type	Part Number	Pkg qty	Weight (1 pce) g
Ground	Green-yellow	ZS70-PE	1SNK522150R0000	10	222.00

Technical data valid for copper conductors only.

# ZS95 screw clamp terminal blocks

## Feed-through - 26 mm 1.024 in spacing

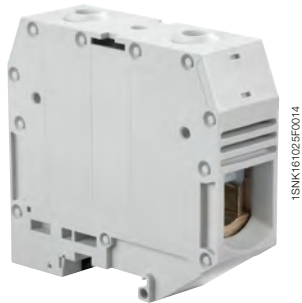

ZS95

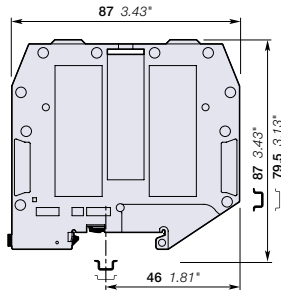

26 mm 1.024 in spacing

### Description

Closed terminal block:

- No end section needed,
- Optimized rigidity,
- Perfectly adapted to solar applications: 1250 V DC (1000 V AC) IEC and 1000 V UL.

### Ordering details

Description	Color	Type	Part Number	Pkg qty	Weight (1 pce)
Feed-through Closed block	Grey <input type="checkbox"/>	ZS95	1SNK526010R0000	10	215.10
	Blue <input type="checkbox"/>	ZS95-BL	1SNK526020R0000	10	215.10
	Yellow <input type="checkbox"/>	ZS95-YL	1SNK526060R0000	10	215.10

### Main technical data

Connecting capacity		IEC	UL - CSA	Mounting instructions	
1 conductor per clamp	Rigid: Solid/Stranded	35 ... 120 mm <sup>2</sup>	2 ... 0000 AWG	Rail	TH 35-7.5, TH 35-15
	Flexible without ferrule	35 ... 95 mm <sup>2</sup>		Wire stripping length	26 mm 1.024 in
	Flexible with non insulated ferrule	35 ... 50 mm <sup>2</sup>			
	Flexible with insulated ferrule	35 ... 50 mm <sup>2</sup>			
	Gauge	B12			
2 conductors per clamp	Rigid: Solid/Stranded	25 ... 35 mm <sup>2</sup>	4 ... 2 AWG	Tool	Allen key Ø 6 mm Ø 0.236 in
	Flexible without ferrule	25 ... 35 mm <sup>2</sup>			
	Flexible with twin ferrule	16 mm <sup>2</sup>	6 AWG		
Rated current / Rated cross section		232 A / 95 mm <sup>2</sup>	230 A / 0000 AWG	Torque	9.25 Nm ± 0.25 81.7 lb.in ± 2.21
Rated short-time withstand current (1s)		11400 A			
Short Circuit Current Rating (with specific conditions)			100 kA		
Rated voltage		1000 V	1000 V		
Impulse withstand voltage		8000 V			
Protection		IP10	NEMA 1		
Increased safety Ex e		693 V 232 A IEC/EN 60079-7 - IM2 II 2 GD Ex eb I/II/III C - 600 V 230 A UL 60079-7 - Class I, Zone 1, AEx e II			

The connecting capacity data for one Rigid: Solid/Stranded, or one Flexible conductor (when applicable) is a mandatory information required by IEC, UL and CSA standards (Copper conductors). All other data are provided as supplementary information only. For more details, please consult our CB, UL or CSA certificates and technical datasheet available on <http://www.TE.com>



### Accessories

Description	Color	Type	Part Number	Pkg qty	Weight (1 pce)	
1 End stops	Dark grey <input type="checkbox"/>	BAZH1	1SNK900102R0000	20	24.00	
2 Jumper bars		2 poles 232 A (IEC)	JB26-2	1SNK926302R0000	5	41.20
		3 poles 232 A (IEC)	JB26-3	1SNK926303R0000	5	65.70
		5 poles 232 A (IEC)	JB26-5	1SNK926305R0000	5	115.70
		10 poles 232 A (IEC)	JB26-10	1SNK926310R0000	5	241.50
		Blank marker	White <input type="checkbox"/>	MG-CPM 13 41791	1SNB041791R0612	1680
3 Terminal block markers		Blank card	MC812	1SNK160000R0000	22	10.00
			MC812PA	1SNK169999R0000	20	14.00
		Universal wire markers holder	Grey <input type="checkbox"/>	UMH	1SNK900611R0000	10

Complete list of accessories is indicated in the terminal block datasheet including end stops.

Some accessories such as jumper bars may modify the terminal block's ratings: Complete information available in the accessories section of the catalog.

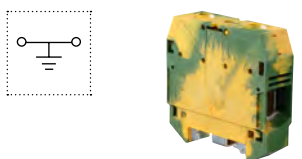

### Ground screw clamp terminal blocks

Description	Color	Type	Part Number	Pkg qty	Weight (1 pce)
Ground Profile aligned with ZS95	Green-yellow <input type="checkbox"/>	ZS95-PE	1SNK526150R0000	10	278.00

Technical data valid for copper conductors only.

# ZS150 screw clamp terminal blocks

## Feed-through - 31 mm 1.220 in spacing



ZS150

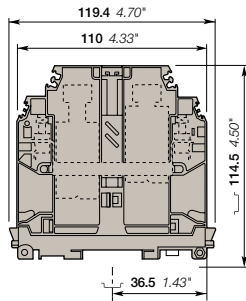

31 mm 1.220 in spacing

### Description

- Perfectly adapted to solar applications : 1500V DC (1000V AC) IEC and 1000V UL,
- Closed terminal block: no end section needed, optimized rigidity,
- Ease your voltage monitoring or distribution with the 2 built-in derivations,
- Use of jumper bars requires the user to cut-out the partition.

### Ordering details

Description	Color	Type	Part Number	Pkg qty	Weight (1 pce) g
Feed-through Closed block with 2 x 10 mm <sup>2</sup> derivations.	Grey <input type="checkbox"/>	ZS150	1SNK531010R0000	5	318.00
	Blue <input type="checkbox"/>	ZS150-BL	1SNK531020R0000	5	318.00
	Yellow <input type="checkbox"/>	ZS150-YL	1SNK531060R0000	5	318.00

### Main technical data

Connecting capacity	IEC	UL	CSA	Mounting instructions	
<b>Main circuit with 1 conductor per clamp</b>	Rigid: Solid/Stranded Flexible without ferrule Flexible with insulated ferrule Gauge	35 ... 185 mm <sup>2</sup> 50 ... 150 mm <sup>2</sup> B14	2 ... 350 Kcmil	2 ... 350 Kcmil	Main circuit Wire stripping length Tool
<b>Derivation with 1 conductor per clamp</b>	Rigid: Solid/Stranded Flexible without ferrule Gauge	0.5 ... 16 mm <sup>2</sup> 0.5 ... 10 mm <sup>2</sup> B6	20 ... 8 AWG	20 ... 8 AWG 20 ... 8 Kcmil	Derivation Wire stripping length Tool
<b>Rated current / Rated cross section</b>	Main circuit Derivation	Copper Aluminium	309 A / 150 mm <sup>2</sup> 57 A / 10 mm <sup>2</sup>	310 A / 350 Kcmil 50 A / 8 AWG	Torque
<b>Rated short-time withstand current (1s)</b>		18000 A			
<b>Rated voltage</b>	V AC V DC	1000 V 1500	1000 V	1000 V	
<b>Impulse withstand voltage</b>		12000 V			
<b>Protection</b>		IP10	NEMA 1		
<b>Increased safety Ex e</b>		1000 V 309 A IEC/EN 60079-7 - IM2 II 2 GD Ex eb I/II/III/C			

The connecting capacity data for one Rigid: Solid/Stranded, or one Flexible conductor (when applicable) is a mandatory information required by IEC, UL and CSA standards (Copper conductors). All other data are provided as supplementary information only. For more details, please consult our CB, UL or CSA certificates and technical datasheet available on <http://www.TE.com>



### Accessories

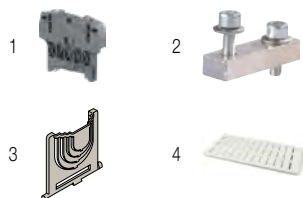

Description	Color	Type	Part Number	Pkg qty	Weight (1 pce) g	
1 <b>End stops</b>	Dark grey <input type="checkbox"/>	BAZH1	1SNK900102R0000	20	24.00	
2 <b>Jumper bars</b>		BJMI31.2	1SNA206053R0700	1	120.00	
		BJMI31.3	1SNA206054R0000	1	190.00	
3 <b>Protecting covers</b>		CPBP1	1SNA399788R1600	20	0.40	
4 <b>Terminal block markers</b>		RC1010	1SNA238000R1600	10	1.30	
		MG-CPM 13 41791	1SNB041791R0612	1680	0.27	
		MC812	1SNK160000R0000	22	10.00	
		MC812PA	1SNK169999R0000	20	14.00	
	Universal wire markers holder	Grey <input type="checkbox"/>	UMH	1SNK900611R0000	10	0.20

Complete list of accessories is indicated in the terminal block datasheet including end stops.

Some accessories such as jumper bars may modify the terminal block's ratings: Complete information available in the accessories section of the catalog.

Technical data valid for copper conductors only.

# ZS240 screw clamp terminal blocks

## Feed-through - 36 mm 1.417 in spacing

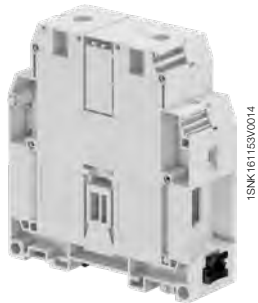

ZS240

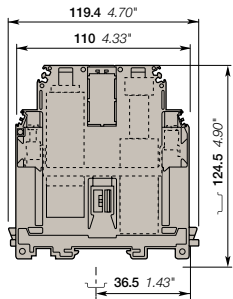

36 mm 1.417 in spacing

### Description

- Perfectly adapted to solar applications : 1500V DC (1000V AC) IEC and 1000V UL,
- UL Certified for aluminum cables use - Closed terminal block: no end section needed, optimized rigidity,
- Ease your voltage monitoring or distribution with the 2 built-in derivations,
- Use of jumper bars requires the user to cut-out the partition.

### Ordering details

Description	Color	Type	Part Number	Pkg qty	Weight (1 pce)
Feed-through Closed block with 2 x 10 mm <sup>2</sup> derivations.	Grey <input type="checkbox"/>	ZS240	1SNK536010R0000	5	366.00
	Blue <input type="checkbox"/>	ZS240-BL	1SNK536020R0000	5	366.00
	Yellow <input type="checkbox"/>	ZS240-YL	1SNK536060R0000	5	366.00

### Main technical data

Connecting capacity	IEC	UL	CSA	Mounting instructions	
<b>Main circuit with 1 conductor per clamp</b>	Rigid: Solid/Stranded Flexible without ferrule Flexible with insulated ferrule Gauge	50 ... 300 mm <sup>2</sup> 50 ... 240 mm <sup>2</sup> B14	0 ... 500 Kcmil	0 ... 500 Kcmil	Main circuit
<b>Derivation with 1 conductor per clamp</b>	Rigid: Solid/Stranded Flexible without ferrule Gauge	0.5 ... 16 mm <sup>2</sup> 0.5 ... 10 mm <sup>2</sup> B6	20 ... 8 AWG	20 ... 8 AWG	Wire stripping length Tool Torque
<b>Rated current / Rated cross section</b>	Main circuit Derivation	Copper Aluminium	415 A / 240 mm <sup>2</sup> 57 A / 10 mm <sup>2</sup>	380 A / 500 Kcmil 271 / 500 Kcmil 50 A / 8 AWG	38 mm 1.496 in Allen key Ø 8 mm Ø 0.315 in 25 Nm 221.3 lb.in
<b>Rated short-time withstand current (1s)</b>	28800 A		1000 V		Derivation
<b>Rated voltage</b>	V AC V DC	1000 V 1500	1000 V	1000 V	Wire stripping length Tool Torque
<b>Impulse withstand voltage</b>	12000 V				12 mm 0.47 in Flat screwdriver Ø 4 mm Ø 0.157 in 1.2 Nm ... 1.4 Nm 10.6 lb.in ... 12.3 lb.in
<b>Protection</b>	IP10		NEMA 1		
<b>Increased safety Ex e</b>	1000 V 415 A IEC/EN 60079-7 - IM2 II 2 GD Ex eb I/II/III				

The connecting capacity data for one Rigid: Solid/Stranded, or one Flexible conductor (when applicable) is a mandatory information required by IEC, UL and CSA standards (Copper conductors). All other data are provided as supplementary information only. For more details, please consult our CB, UL or CSA certificates and technical datasheet available on <http://www.TE.com>



### Accessories

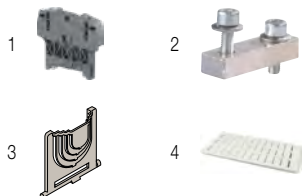

Description	Color	Type	Part Number	Pkg qty	Weight (1 pce)	
1 End stops	Dark grey <input type="checkbox"/>	BAZH1	1SNK900102R0000	20	24.00	
2 Jumper bars		2 poles	BJMI36.2	1SNA206126R2500	1	170.00
		3 poles	BJMI36.3	1SNA206223R0600	1	260.00
3 Protecting covers		CPBP2	1SNA399787R0500	20	1.30	
4 Terminal block markers	White <input type="checkbox"/>	Blank card	RC1010	1SNA238000R1600	10	1.30
		Blank marker	MG-CPM 13 41791	1SNB041791R0612	1680	0.27
		Blank card	MC812	1SNK160000R0000	22	10.00
		Blank card	MC812PA	1SNK169999R0000	20	14.00
Universal wire markers holder	Grey <input type="checkbox"/>	UMH	1SNK900611R0000	10	0.20	

Complete list of accessories is indicated in the terminal block datasheet including end stops. Some accessories such as jumper bars may modify the terminal block's ratings: Complete information available in the accessories section of the catalog.

Technical data valid for copper conductors only.

# ZS4-PE screw clamp terminal blocks

Ground - 5.2 mm 0.205 in spacing

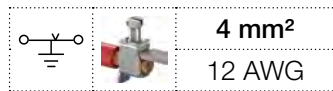

4 mm<sup>2</sup>  
12 AWG



1SNK161018F0014

ZS4-PE

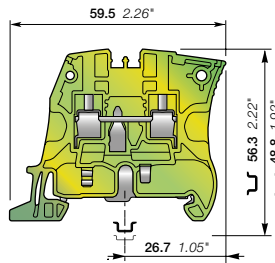

5.2 mm 0.205 in spacing

## Description

Improve the safety of your installation in the event of a short-circuit thanks to our screwless rail contact:

- Rail contact non operator dependent,
- Performances above the requirements of IEC 60947-7-2 terminal block standard,
- Secured snap on or remove from the rail.

## Ordering details

Description	Color	Type	Part Number	Pkg qty	Weight (1 pce) g
Ground Screwless rail connection	Green-yellow	ZS4-PE	1SNK505150R0000	20	12.10

## Main technical data

Connecting capacity		IEC	UL - CSA	Mounting instructions	
<b>1 conductor per clamp</b>	Rigid: Solid/Stranded	0.2 ... 4 mm <sup>2</sup>	24 ... 12 AWG	Rail	TH 35-7.5, TH 35-15
	Flexible without ferrule	0.22 ... 4 mm <sup>2</sup>		Wire stripping length	10.5 mm 0.412 in
	Flexible with non insulated ferrule	0.22 ... 4 mm <sup>2</sup>	24 ... 12 AWG		
	Flexible with insulated ferrule	0.22 ... 2.5 mm <sup>2</sup>	24 ... 14 AWG		
	Gauge	A3-B3			
				Tool	Flat screwdriver Ø 3.5 mm Ø 0.138 in
<b>Rated cross section</b>		4 mm <sup>2</sup>	12 AWG	Torque	0.6 Nm ± 0.1 5.31 lb.in ± 0.885
<b>Rated short-time withstand current (1s)</b>		480 A	396 A		
<b>Protection</b>		IP20	NEMA 1		
<b>Explosive atmosphere classification</b>		IM2 II 2 GD Ex eb I/IIIC - Class I, Zone 1, AEx e II, Ex e II U			

The connecting capacity data for one Rigid: Solid/Stranded, or one Flexible conductor (when applicable) is a mandatory information required by IEC, UL and CSA standards (Copper conductors). All other data are provided as supplementary information only. For more details, please consult our CB, UL or CSA certificates and technical datasheet available on <http://www.TE.com>

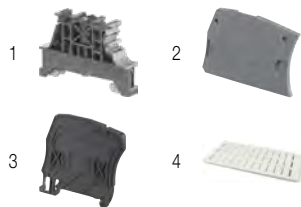

## Accessories

Description	Color	Type	Part Number	Pkg qty	Weight (1 pce) g
1 <b>End stops</b> 10 mm 0.394 in	Dark grey	BAM4	1SNK900001R0000	50	14.00
2 <b>End sections</b> 2.2 mm 0.087 in	Dark grey	ES4	1SNK505910R0000	20	2.20
3 <b>Circuit separators</b> 3 mm 0.118 in	Dark grey	CS-R1	1SNK900103R0000	20	5.20
4 <b>Terminal block markers</b>	White	MG-CPM 13 41790	1SNB041790R0512	1960	0.23
		MC512	1SNK140000R0000	22	9.00
		MC512PA	1SNK149999R0000	20	10.00
Universal wire markers holder	Grey	UMH	1SNK900611R0000	10	0.20

Complete list of accessories is indicated in the terminal block datasheet including end stops.

Some accessories such as jumper bars may modify the terminal block's ratings: Complete information available in the accessories section of the catalog.

Technical data valid for copper conductors only.



# ZS6-PE screw clamp terminal blocks

Ground - 6 mm 0.236 in spacing

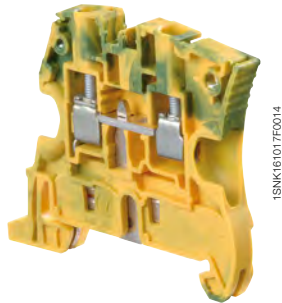
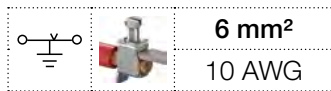

1SNK161017F0014

ZS6-PE

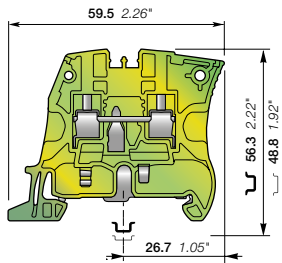

6 mm 0.236 in spacing

## Description

Improve the safety of your installation in the event of a short-circuit thanks to our screwless rail contact:

- Rail contact non operator dependent,
- Performances above the requirements of IEC 60947-7-2 terminal block standard,
- Secured snap on or remove from the rail.

## Ordering details

Description	Color	Type	Part Number	Pkg qty	Weight (1 pce)
Ground Screwless rail connection	Green-yellow	ZS6-PE	1SNK506150R0000	20	13.70

## Main technical data

Connecting capacity		IEC	UL - CSA	Mounting instructions	
1 conductor per clamp	Rigid: Solid/Stranded	0.2 ... 6 mm <sup>2</sup>	24 ... 10 AWG	Rail	TH 35-7.5, TH 35-15
	Flexible without ferrule	0.2 ... 6 mm <sup>2</sup>		Wire stripping length	10.5 mm 0.412 in
	Flexible with non insulated ferrule	0.22 ... 4 mm <sup>2</sup>	24 ... 12 AWG		
	Flexible with insulated ferrule	0.22 ... 4 mm <sup>2</sup>	24 ... 12 AWG		
	Gauge	A4-B3		Tool	Flat screwdriver Ø 4 mm Ø 0.157 in
Rated cross section		6 mm <sup>2</sup>	10 AWG	Torque	0.85 Nm ± 0.15 7.52 lb.in ± 1.33
Rated short-time withstand current (1s)		720 A	636 A		
Protection		IP20	NEMA 1		
Explosive atmosphere classification		IM2 II 2 GD Ex eb III/IIIC - Class I, Zone 1, AEx e II, Ex e II U			

The connecting capacity data for one Rigid: Solid/Stranded, or one Flexible conductor (when applicable) is a mandatory information required by IEC, UL and CSA standards (Copper conductors). All other data are provided as supplementary information only. For more details, please consult our CB, UL or CSA certificates and technical datasheet available on <http://www.TE.com>



## Accessories

Description	Color	Type	Part Number	Pkg qty	Weight (1 pce)
1 End stops 10 mm 0.394 in	Dark grey	BAM4	1SNK900001R0000	50	14.00
2 End sections 2.2 mm 0.087 in	Dark grey	ES4	1SNK505910R0000	20	2.20
3 Circuit separators 3 mm 0.118 in	Dark grey	CS-R1	1SNK900103R0000	20	5.20
4 Terminal block markers	White	MG-CPM 13 41791	1SNB041791R0612	1680	0.27
		MC612	1SNK150000R0000	22	10.00
		MC612PA	1SNK159999R0000	20	11.00
Universal wire markers holder	Grey	UMH	1SNK900611R0000	10	0.20

Complete list of accessories is indicated in the terminal block datasheet including end stops. Some accessories such as jumper bars may modify the terminal block's ratings: Complete information available in the accessories section of the catalog.

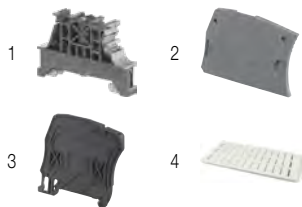

Technical data valid for copper conductors only.

# ZS6-3S-PE screw clamp terminal blocks

Ground with 3 connections - 6 mm 0.236 in spacing

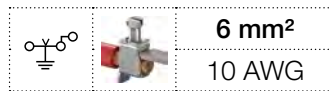

ZS6-3S-PE

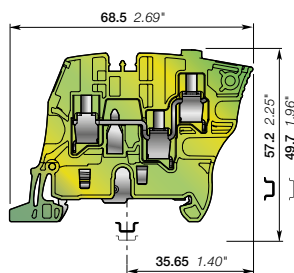

6 mm 0.236 in spacing

## Description

Improve the safety of your installation in the event of a short-circuit thanks to our screwless rail contact:

- rail contact non operator dependent, secured snap on or off the rail,
- Same profile as ZS6-3S for aligned marking and identical end section.

## Ordering details

Description	Color	Type	Part Number	Pkg qty	Weight (1 pce) g
Ground Screwless rail connection	Green-yellow	ZS6-3S-PE	1SNK506151R0000	25	16.20

## Main technical data

Connecting capacity		IEC	UL - CSA	Mounting instructions	
1 conductor per clamp	Rigid: Solid/Stranded	0.2 ... 6 mm <sup>2</sup>	24 ... 10 AWG	Rail	TH 35-7.5, TH 35-15
	Flexible without ferrule	0.22 ... 6 mm <sup>2</sup>		Wire stripping length	10.5 mm 0.413 in
	Flexible with non insulated ferrule	0.22 ... 4 mm <sup>2</sup>	24 ... 12 AWG		
	Flexible with insulated ferrule	0.22 ... 4 mm <sup>2</sup>	24 ... 12 AWG		
	Gauge	A4-B3		Tool	Flat screwdriver Ø 4 mm Ø 0.157 in
Rated cross section		4 mm <sup>2</sup>	10 AWG	Torque	0.75 Nm ± 0.05 6.64 lb.in ± 0.443
Maximum cross section		6 mm <sup>2</sup>			
Rated short-time withstand current (1s)		480 A	636 A		
Maximum short-time withstand current (1s)		480 A		Protection	
Protection		IP20	NEMA 1	Explosive atmosphere classification	
Explosive atmosphere classification		IM2 II 2 GD Ex eb I/IIIC - Class I, Zone 1, AEx e II			

The connecting capacity data for one Rigid: Solid/Stranded, or one Flexible conductor (when applicable) is a mandatory information required by IEC, UL and CSA standards (Copper conductors). All other data are provided as supplementary information only. For more details, please consult our CB, UL or CSA certificates and technical datasheet available on <http://www.TE.com>

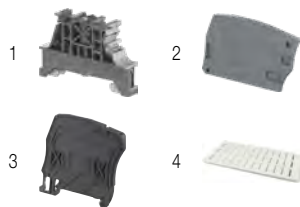

## Accessories

Description	Color	Type	Part Number	Pkg qty	Weight (1 pce) g
1 End stops	Dark grey	BAM4	1SNK900001R0000	50	14.00
2 End sections	Dark grey	ES6-3S	1SNK505912R0000	20	2.50
3 Circuit separators	Dark grey	CS-R1	1SNK900103R0000	20	5.20
4 Terminal block markers	White	MG-CPM 13 41791	1SNB041791R0612	1680	0.27
		MC612	1SNK150000R0000	22	10.00
		MC612PA	1SNK159999R0000	20	11.00
Universal wire markers holder	Grey	UMH	1SNK900611R0000	10	0.20

Complete list of accessories is indicated in the terminal block datasheet including end stops. Some accessories such as jumper bars may modify the terminal block's ratings: Complete information available in the accessories section of the catalog.

Technical data valid for copper conductors only.

# ZS6-4S-PE screw clamp terminal blocks

Ground with 4 connections - 6 mm 0.236 in spacing



ZS6-4S-PE

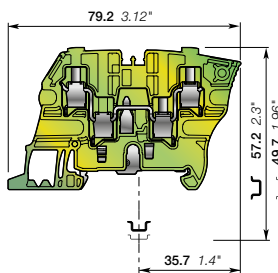

6 mm 0.236 in spacing

## Description

Improve the safety of your installation in the event of a short-circuit thanks to our screwless rail contact:

- rail contact non operator dependent, secured snap on or off the rail,
- Same profile as ZS6-4S for aligned marking and identical end section.

## Ordering details

Description	Color	Type	Part Number	Pkg qty	Weight (1 pce) g
Ground Screwless rail connection	Green-yellow	ZS6-4S-PE	1SNK506152R0000	25	19.40

## Main technical data

Connecting capacity	IEC	UL - CSA	Mounting instructions
<b>1 conductor per clamp</b>			
Rigid: Solid/Stranded	0.2 ... 6 mm <sup>2</sup>	24 ... 10 AWG	Rail
Flexible without ferrule	0.22... 6 mm <sup>2</sup>		Wire stripping length
Flexible with non insulated ferrule	0.22 ... 4 mm <sup>2</sup>	24 ... 12 AWG	Tool
Flexible with insulated ferrule	0.22 ... 4 mm <sup>2</sup>	24 ... 12 AWG	Torque
Gauge	A4-B3		
<b>Rated cross section</b>	4 mm <sup>2</sup>	10 AWG	
<b>Maximum cross section</b>	6 mm <sup>2</sup>		
<b>Rated short-time withstand current (1s)</b>	480 A	636 A	
<b>Maximum short-time withstand current (1s)</b>	480 A		
<b>Protection</b>	IP20	NEMA 1	

**Explosive atmosphere classification** IM2 II 2 GD Ex eb I/II/III - Class I, Zone 1, AEx e II

The connecting capacity data for one Rigid: Solid/Stranded, or one Flexible conductor (when applicable) is a mandatory information required by IEC, UL and CSA standards (Copper conductors). All other data are provided as supplementary information only. For more details, please consult our CB, UL or CSA certificates and technical datasheet available on <http://www.TE.com>



## Accessories

Description	Color	Type	Part Number	Pkg qty	Weight (1 pce) g
1 End stops 10 mm 0.394 in	Dark grey	BAM4	1SNK900001R0000	50	14.00
2 End sections 2.2 mm 0.087 in	Dark grey	ES6-4S	1SNK505911R0000	20	3.10
3 Circuit separators 3 mm 0.118 in	Dark grey	CS-R1	1SNK900103R0000	20	5.20
4 Terminal block markers	White	MG-CPM 13 41791	1SNB041791R0612	1680	0.27
		MC612	1SNK150000R0000	22	10.00
		MC612PA	1SNK159999R0000	20	11.00
Universal wire markers holder	Grey	UMH	1SNK900611R0000	10	0.20

Complete list of accessories is indicated in the terminal block datasheet including end stops.

Some accessories such as jumper bars may modify the terminal block's ratings. Complete information available in the accessories section of the catalog.

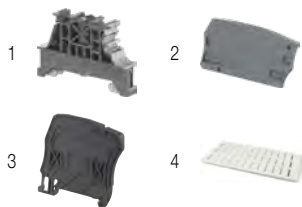

Technical data valid for copper conductors only.

# ZS10-PE screw clamp terminal blocks

Ground - 8 mm 0.315 in spacing



ZS10-PE

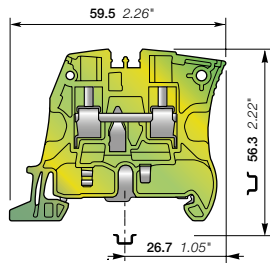

8 mm 0.315 in spacing

## Description

Improve the safety of your installation in the event of a short-circuit thanks to our screwless rail contact:

- Rail contact non operator dependent,
- Performances above the requirements of IEC 60947-7-2 terminal block standard,
- Secured snap on or remove from the rail.

## Ordering details

Description	Color	Type	Part Number	Pkg qty	Weight (1 pce) g
Ground Screwless rail connection	Green-yellow	ZS10-PE	1SNK508150R0000	20	22.50

## Main technical data

Connecting capacity		IEC	UL - CSA	Mounting instructions	
<b>1 conductor per clamp</b>	Rigid: Solid/Stranded	0.5 ... 10 mm <sup>2</sup>	24 ... 6 AWG	Rail	TH 35-7.5, TH 35-15
	Flexible without ferrule	0.5 ... 10 mm <sup>2</sup>		Wire stripping length	12 mm 0.472 in
	Flexible with non insulated ferrule	0.5 ... 10 mm <sup>2</sup>	24 ... 8 AWG		
	Flexible with insulated ferrule	0.5 ... 6 mm <sup>2</sup>	24 ... 8 AWG		
	Gauge	A5-B5		Tool	Flat screwdriver Ø 4 mm Ø 0.157 in
<b>Rated cross section</b>		10 mm <sup>2</sup>	6 AWG	Torque	1.3 Nm ± 0.3 11.5 lb.in ± 2.65
<b>Rated short-time withstand current (1s)</b>		1200 A	1596 A		
<b>Protection</b>		IP20	NEMA 1		
<b>Explosive atmosphere classification</b>		IM2 II 2 GD Ex eb I/IIIC - Class I, Zone 1, AEx e II, Ex e II U			

The connecting capacity data for one Rigid: Solid/Stranded, or one Flexible conductor (when applicable) is a mandatory information required by IEC, UL and CSA standards (Copper conductors). All other data are provided as supplementary information only. For more details, please consult our CB, UL or CSA certificates and technical datasheet available on <http://www.TE.com>

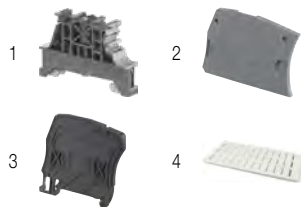

## Accessories

Description	Color	Type	Part Number	Pkg qty	Weight (1 pce) g
1 <b>End stops</b>	Dark grey	BAM4	1SNK900001R0000	50	14.00
2 <b>End sections</b>	Dark grey	ES4	1SNK505910R0000	20	2.20
3 <b>Circuit separators</b>	Dark grey	CS-R1	1SNK900103R0000	20	5.20
4 <b>Terminal block markers</b>	White	MG-CPM 13 41791	1SNB041791R0612	1680	0.27
		MC812	1SNK160000R0000	22	10.00
		MC812PA	1SNK169999R0000	20	14.00
Universal wire markers holder	Grey	UMH	1SNK900611R0000	10	0.20

Complete list of accessories is indicated in the terminal block datasheet including end stops.

Some accessories such as jumper bars may modify the terminal block's ratings: Complete information available in the accessories section of the catalog.

Technical data valid for copper conductors only.

# ZS16-PE screw clamp terminal blocks

Ground - 10 mm 0.394 in spacing

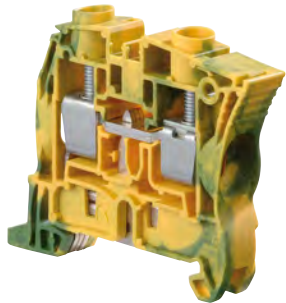

1SNK161019F0014

ZS16-PE

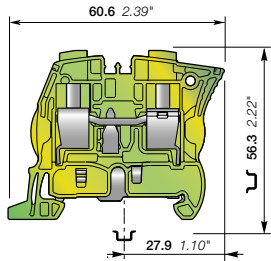

10 mm 0.394 in spacing

## Description

- Improve the safety of your installation in the event of a short-circuit thanks to our screwless rail contact:
- Rail contact non operator dependent,
  - Performances above the requirements of IEC 60947-7-2 terminal block standard,
  - Secured snap on or remove from the rail,
  - PE.N function available by combining ZS16-PE with ZS16-BL and 2 poles jumper bar JB10-2.

## Ordering details

Description	Color	Type	Part Number	Pkg qty	Weight (1 pce) g
Ground Screwless rail connection	Green-yellow	ZS16-PE	1SNK510150R0000	20	32.00

## Main technical data

Connecting capacity	IEC	UL - CSA	Mounting instructions	
<b>1 conductor per clamp</b> Rigid: Solid/Stranded Flexible without ferrule Flexible with non insulated ferrule Flexible with insulated ferrule Gauge	0.5 ... 16 mm <sup>2</sup>	24 ... 4 AWG	Rail	TH 35-7.5, TH 35-15
	0.5 ... 16 mm <sup>2</sup>	24 ... 4 AWG	Wire stripping length	13.5 mm 0.531 in
	0.5 ... 16 mm <sup>2</sup>	24 ... 4 AWG	Tool	Flat screwdriver Ø 5.5 mm Ø 0.217 in
	0.5 ... 10 mm <sup>2</sup>	24 ... 8 AWG		
	A6-B6		Torque	1.8 Nm ± 0.2 15.9 lb.in ± 1.77
<b>Rated cross section</b>	16 mm <sup>2</sup>	4 AWG		
<b>Rated short-time withstand current (1s)</b>	1920 A	2544 A		
<b>Protection</b>	IP20	NEMA 1		
<b>Explosive atmosphere classification</b>	IM2 II 2 GD Ex eb III/IIIC - Class I, Zone 1, AEx e II, Ex e II U			

The connecting capacity data for one Rigid: Solid/Stranded, or one Flexible conductor (when applicable) is a mandatory information required by IEC, UL and CSA standards (Copper conductors). All other data are provided as supplementary information only. For more details, please consult our CB, UL or CSA certificates and technical datasheet available on <http://www.TE.com>



## Accessories

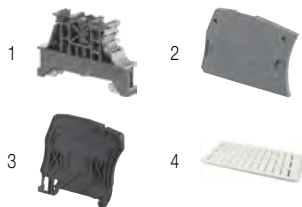

Description	Color	Type	Part Number	Pkg qty	Weight (1 pce) g
1 <b>End stops</b> 10 mm 0.394 in	Dark grey	BAM4	1SNK900001R0000	50	14.00
2 <b>End sections</b> 2.2 mm 0.087 in	Dark grey	ES4	1SNK505910R0000	20	2.20
3 <b>Circuit separators</b> 3 mm 0.118 in	Dark grey	CS-R1	1SNK900103R0000	20	5.20
4 <b>Terminal block markers</b>	White	MG-CPM 13 41791	1SNB041791R0612	1680	0.27
		MC812	1SNK160000R0000	22	10.00
		MC812PA	1SNK169999R0000	20	14.00
Universal wire markers holder	Grey	UMH	1SNK900611R0000	10	0.20

Complete list of accessories is indicated in the terminal block datasheet including end stops. Some accessories such as jumper bars may modify the terminal block's ratings: Complete information available in the accessories section of the catalog.

Technical data valid for copper conductors only.



# ZS25-PE screw clamp terminal blocks

Ground - 12 mm 0.472 in spacing



25 mm<sup>2</sup>  
3 AWG

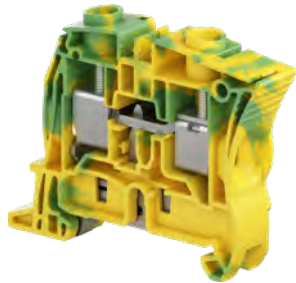

1SNK161092V0014

ZS25-PE

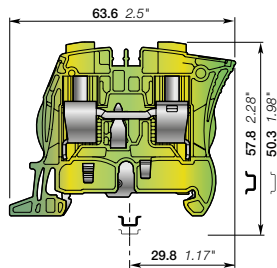

12 mm 0.472 in spacing

## Description

Improve the safety of your installation in the event of a short-circuit thanks to our screwless rail contact:

- rail contact non operator dependent, secured snap on or off the rail,
- Same profile as ZS25 for aligned marking and identical end section.

## Ordering details

Description	Color	Type	Part Number	Pkg qty	Weight (1 pce) g
Ground Screwless rail connection	Green-yellow	ZS25-PE	1SNK512150R0000	20	38.00

## Main technical data

Connecting capacity		IEC	UL - CSA	Mounting instructions	
1 conductor per clamp	Rigid: Solid/Stranded	0.5 ... 25 mm <sup>2</sup>	24 ... 3 AWG	Rail	 TH 35-7.5, TH 35-15
	Flexible without ferrule	0.5 ... 25 mm <sup>2</sup>		Wire stripping length	 13.5 mm 0.531 in
	Flexible with non insulated ferrule	0.5 ... 16 mm <sup>2</sup>	24 ... 4 AWG		
	Flexible with insulated ferrule	0.5 ... 16 mm <sup>2</sup>	24 ... 8 AWG		
Gauge		A6-B6		Tool	 Flat screwdriver Ø 5.5 mm Ø 0.217 in
Rated cross section		16 mm <sup>2</sup>	3 AWG	Torque	 1.8 Nm ± 0.2 15.9 lb.in ± 1.77
Maximum cross section		25 mm <sup>2</sup>			
Rated short-time withstand current (1s)		1920 A	3204 A		
Maximum short-time withstand current (1s)		3000 A			
Protection		IP20	NEMA 1		

## Explosive atmosphere classification

IM2 II 2 GD Ex eb I/IIIC - Class I, Zone 1, AEx e II, Ex e II U

The connecting capacity data for one Rigid: Solid/Stranded, or one Flexible conductor (when applicable) is a mandatory information required by IEC, UL and CSA standards (Copper conductors). All other data are provided as supplementary information only. For more details, please consult our CB, UL or CSA certificates and technical datasheet available on <http://www.TE.com>

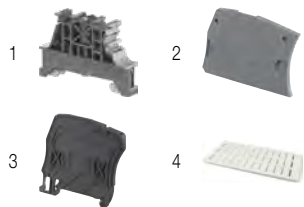

## Accessories

Description	Color	Type	Part Number	Pkg qty	Weight (1 pce) g
1 End stops	Dark grey	BAM4	1SNK900001R0000	50	14.00
2 End sections	Dark grey	ES4	1SNK505910R0000	20	2.20
3 Circuit separators	Dark grey	CS-R1	1SNK900103R0000	20	5.20
4 Terminal block markers	White	MG-CPM 13 41791	1SNB041791R0612	1680	0.27
		MC812	1SNK160000R0000	22	10.00
		MC812PA	1SNK169999R0000	20	14.00
Universal wire markers holder	Grey	UMH	1SNK900611R0000	10	0.20

Complete list of accessories is indicated in the terminal block datasheet including end stops.

Some accessories such as jumper bars may modify the terminal block's ratings: Complete information available in the accessories section of the catalog.

Technical data valid for copper conductors only.

# ZS35-PE screw clamp terminal blocks

Ground - 16 mm 0.630 in spacing

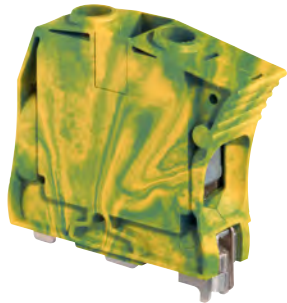

1SNK161005F0014

ZS35-PE

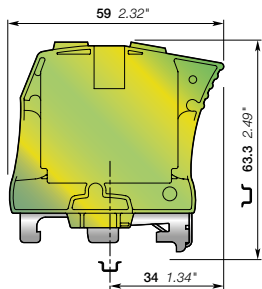

16 mm 0.630 in spacing

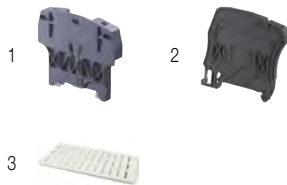

## Description

Reliable electrical and mechanical contact with the rail that exceeds the requirements of IEC 60947-7-2 terminal block standard.

## Ordering details

Description	Color	Type	Part Number	Pkg qty	Weight (1 pce) g
Ground Screw rail connection	Green-yellow	ZS35-PE	1SNK516150R0000	20	81.80

## Main technical data

Connecting capacity		IEC	UL - CSA	Mounting instructions	
1 conductor per clamp	Rigid: Solid/Stranded	6 ... 35 mm <sup>2</sup>	10 ... 2 AWG	Rail	TH 35-7.5, TH 35-15
	Flexible without ferrule	6 ... 35 mm <sup>2</sup>		Wire stripping length	17 mm 0.669 in
	Flexible with non insulated ferrule	4 ... 35 mm <sup>2</sup>	10 ... 2 AWG	Tool	Flat screwdriver Ø 6.5 mm Ø 0.256 in
	Flexible with insulated ferrule	4 ... 35 mm <sup>2</sup>	10 ... 2 AWG	Screw clamp	
Gauge		A9		Rail connection screw	Ø 5.5 Ø 0.217
Rated cross section		35 mm <sup>2</sup>	2 AWG	Torque	2.65 Nm ± 0.15 23.4 lb.in ± 1.33
Rated short-time withstand current (1s)		4200 A	4032 A	Screw clamp	
Protection		IP10	NEMA 1	Rail connection screw	1.6 Nm ± 0.15 Nm 14.2 lb.in ± 1.33 lb.in
Explosive atmosphere classification		IM2 II 2 GD Ex eb III/IIIC - Class I, Zone 1, AEx e II			

The connecting capacity data for one Rigid: Solid/Stranded, or one Flexible conductor (when applicable) is a mandatory information required by IEC, UL and CSA standards (Copper conductors). All other data are provided as supplementary information only. For more details, please consult our CB, UL or CSA certificates and technical datasheet available on <http://www.TE.com>



## Accessories

Description	Color	Type	Part Number	Pkg qty	Weight (1 pce) g	
1 End stops 10 mm 0.394 in	Dark grey	BAZH1	1SNK900102R0000	20	24.00	
2 Circuit separators 3 mm 0.118 in	Dark grey	CS-R1	1SNK900103R0000	20	5.20	
3 Terminal block markers	White	Blank marker	MG-CPM 13 41791	1SNB041791R0612	1680	0.27
		Blank card	MC812	1SNK160000R0000	22	10.00
		Universal wire markers holder	MC812PA	1SNK169999R0000	20	14.00
	Grey	UMH	1SNK900611R0000	10	0.20	

Complete list of accessories is indicated in the terminal block datasheet including end stops. Some accessories such as jumper bars may modify the terminal block's ratings: Complete information available in the accessories section of the catalog.

Technical data valid for copper conductors only.

# ZS35-PEN screw clamp terminal blocks

## Ground + neutral - 32 mm 1.260 in spacing



ZS35-PEN

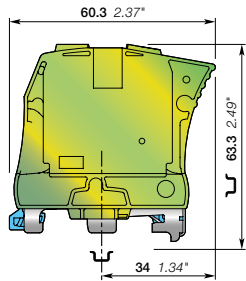

32 mm 1.260 in spacing

### Description

Simplify your PE.N connection with ZS35-PE block connected to ZS35-BL through a pre-mounted jumper.

### Ordering details

Description	Color	Type	Part Number	Pkg qty	Weight (1 pce) g
Ground + neutral	Green-yellow	ZS35-PEN	1SNK516170R0000	10	236.00

### Main technical data

Connecting capacity		IEC	UL - CSA	Mounting instructions	
1 conductor per clamp	Rigid: Solid/Stranded	6 ... 35 mm <sup>2</sup>		Rail	TH 35-7.5, TH 35-15
	Flexible without ferrule	6 ... 35 mm <sup>2</sup>		Wire stripping length	17 mm 0.669 in
	Flexible with non insulated ferrule	6 ... 35 mm <sup>2</sup>	10 ... 2 AWG	Tool	Flat screwdriver
	Flexible with insulated ferrule	6 ... 35 mm <sup>2</sup>		Screw clamp	Ø 6.5 mm Ø 0.256 in
	Gauge	A9		Rail connection screw	Ø 5.5 Ø 0.217
Rated cross section		35 mm <sup>2</sup>		Torque	2.65 Nm ± 0.15 23.5 lb.in ± 1.33
Rated short-time withstand current (1s)		4200 A		Screw clamp	1.6 Nm ± 0.15 Nm 14.2 lb.in ± 1.33 lb.in
Rail connection screw				Rail connection screw	
Protection		IP10	NEMA 1		

The connecting capacity data for one Rigid: Solid/Stranded, or one Flexible conductor (when applicable) is a mandatory information required by IEC, UL and CSA standards (Copper conductors). All other data are provided as supplementary information only. For more details, please consult our CB, UL or CSA certificates and technical datasheet available on <http://www.TE.com>

--	--	--	--	--	--	--	--	--	--



### Accessories

Description	Color	Type	Part Number	Pkg qty	Weight (1 pce) g
1 End stops	Dark grey	BAZH1	1SNK900102R0000	20	24.00
2 Terminal block markers	White	MG-CPM 13 41791	1SNB041791R0612	1680	0.27
		MC812	1SNK160000R0000	22	10.00
	Grey	MC812PA	1SNK169999R0000	20	14.00
		UMH	1SNK900611R0000	10	0.20

Complete list of accessories is indicated in the terminal block datasheet including end stops. Some accessories such as jumper bars may modify the terminal block's ratings: Complete information available in the accessories section of the catalog.

Technical data valid for copper conductors only.

# ZS50-PE screw clamp terminal blocks

Ground - 16 mm 0.630 in spacing



50 mm<sup>2</sup>  
0 AWG



1SNK16109500014

ZS50-PE

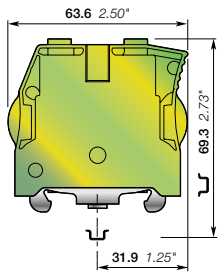

16 mm 0.630 in spacing

## Description

– Reliable electrical and mechanical contact with the rail that exceeds the requirements of the IEC 60947-7-2 terminal block standard.

## Ordering details

Description	Color	Type	Part Number	Pkg qty	Weight (1 pce)
Ground Screw rail connection	Green-yellow	ZS50-PE	1SNK516151R0000	20	83.00 g

## Main technical data

Connecting capacity		IEC	UL - CSA	Mounting instructions	
1 conductor per clamp	Rigid: Solid/Stranded	1 ... 50 mm <sup>2</sup>	18 ... 0 AWG	Rail	TH 35-7.5, TH 35-15
	Flexible without ferrule	1 ... 50 mm <sup>2</sup>	18 ... 0 AWG	Wire stripping length	17 mm 0.669 in
	Flexible with non insulated ferrule	1 ... 50 mm <sup>2</sup>	18 ... 0 AWG	Tool	Flat screwdriver Ø 6.5 mm Ø 0.256 in
	Flexible with insulated ferrule	1 ... 50 mm <sup>2</sup>	18 ... 0 AWG	Screw clamp	
	Gauge	Diã.11		Rail connection screw	Ø 6.5 Ø 0.256
<b>Rated cross section</b>		50 mm <sup>2</sup>	0 AWG	Torque	3 Nm ± 0.50 26.6 lb.in ± 4.43
<b>Rated short-time withstand current (1s)</b>		6000 A	6420 A		
<b>Protection</b>		IP10	NEMA 1	Rail connection screw	3 Nm ± 0.25 Nm 26.553 lb.in ± 2.21 lb.in
<b>Explosive atmosphere classification</b>		IM2 II 2 GD Ex eb III/IIIC - Class I, Zone 1, AEx e II			

The connecting capacity data for one Rigid: Solid/Stranded, or one Flexible conductor (when applicable) is a mandatory information required by IEC, UL and CSA standards (Copper conductors). All other data are provided as supplementary information only. For more details, please consult our CB, UL or CSA certificates and technical datasheet available on <http://www.TE.com>

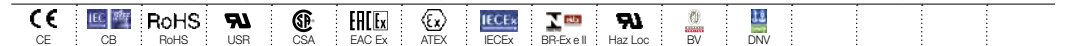

## Accessories

Description	Color	Type	Part Number	Pkg qty	Weight (1 pce)
1 End stops	Dark grey	BAZH1	1SNK900102R0000	20	24.00
2 Terminal block markers	White	MG-CPM 13 41791	1SNB041791R0612	1680	0.27
		MC812	1SNK160000R0000	22	10.00
	MC812PA	1SNK169999R0000	20	14.00	
	Grey	UMH	1SNK900611R0000	10	0.20

Complete list of accessories is indicated in the terminal block datasheet including end stops. Some accessories such as jumper bars may modify the terminal block's ratings. Complete information available in the accessories section of the catalog.

Technical data valid for copper conductors only.

# ZS70-PE screw clamp terminal blocks

Ground - 22 mm 0.866 in spacing

		<b>70 mm<sup>2</sup></b>
		<b>00 AWG</b>

## Description

Reliable electrical and mechanical contact with the rail that exceeds the requirements of IEC 60947-7-2 terminal block standard.

## Ordering details

Description	Color	Type	Part Number	Pkg qty	Weight (1 pce)
Ground Screw rail connection	Green-yellow	ZS70-PE	1SNK522150R0000	10	222.00 g

## Main technical data

Connecting capacity	IEC	UL - CSA	Mounting instructions		
<b>1 conductor per clamp</b>			Rail		TH 35-15
Rigid: Solid/Stranded	16 ... 95 mm <sup>2</sup>	4 ... 00 AWG	Wire stripping length		25 mm 0.984 in
Flexible without ferrule	16 ... 70 mm <sup>2</sup>		Tool		Allen key Ø 6 mm Ø 0.236 in
Flexible with non insulated ferrule	16 ... 50 mm <sup>2</sup>		Screw clamp		Ø 4 Ø 0.158
Flexible with insulated ferrule	16 ... 50 mm <sup>2</sup>		Rail connection screw		
Gauge	B11		Torque		6.5 Nm ± 0.5 57.5 lb.in ± 4.43
<b>Rated cross section</b>	70 mm <sup>2</sup>	00 AWG	Screw clamp		1.9 Nm ± 0.1 Nm 16.82 lb.in ± 0.885 lb.in
<b>Rated short-time withstand current (1s)</b>	8400 A	8088 A	Rail connection screw		
<b>Protection</b>	IP10	NEMA 1			
<b>Explosive atmosphere classification</b>	IM2 II 2 GD Ex eb I/IIIC - Class I, Zone 1, AEx e II, Ex e II U				

The connecting capacity data for one Rigid: Solid/Stranded, or one Flexible conductor (when applicable) is a mandatory information required by IEC, UL and CSA standards (Copper conductors). All other data are provided as supplementary information only. For more details, please consult our CB, UL or CSA certificates and technical datasheet available on <http://www.TE.com>

CE	CB	RoHS	UL	CSA	EAC Ex	ATEX	IECEx	BR-Ex e II	Haz Loc	BV	DNV	Rina

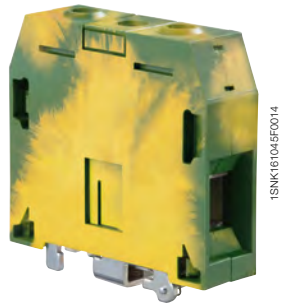

ZS70-PE

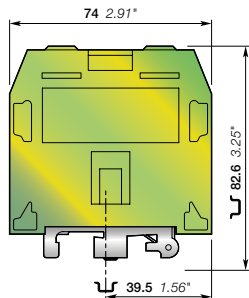

22 mm 0.866 in spacing



## Accessories

Description	Color	Type	Part Number	Pkg qty	Weight (1 pce)
<b>1 End stops</b>	Dark grey	BAZH1	1SNK900102R0000	20	24.00 g
<b>2 Terminal block markers</b>	White	MG-CPM 13 41791	1SNB041791R0612	1680	0.27 g
		MC812	1SNK160000R0000	22	10.00 g
		MC812PA	1SNK169999R0000	20	14.00 g
	Universal wire markers holder	Grey	UMH	1SNK900611R0000	10

Complete list of accessories is indicated in the terminal block datasheet including end stops.

Some accessories such as jumper bars may modify the terminal block's ratings: Complete information available in the accessories section of the catalog.

Technical data valid for copper conductors only.



# ZS95-PE screw clamp terminal blocks

Ground - 26 mm 1.024 in spacing

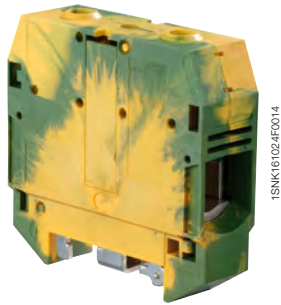

ZS95-PE

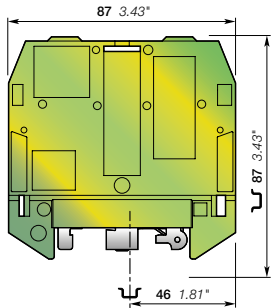

26 mm 1.024 in spacing



## Description

Reliable electrical and mechanical contact with the rail that exceeds the requirements of IEC 60947-7-2 terminal block standard.

## Ordering details

Description	Color	Type	Part Number	Pkg qty	Weight (1 pce)
Ground Screw rail connection	Green-yellow	ZS95-PE	1SNK526150R0000	10	278.00

## Main technical data

Connecting capacity		IEC	UL - CSA	Mounting instructions	
1 conductor per clamp	Rigid: Solid/Stranded	35 ... 120 mm <sup>2</sup>	2 ... 0000 AWG	Rail	TH 35-15
	Flexible without ferrule	35 ... 95 mm <sup>2</sup>		Wire stripping length	26 mm 1.024 in
	Flexible with non insulated ferrule	35 ... 50 mm <sup>2</sup>		Tool	Allen key
	Flexible with insulated ferrule	35 ... 50 mm <sup>2</sup>		Screw clamp	Ø 6 mm Ø 0.236 in
Gauge		B12		Rail connection screw	Ø 4 Ø 0.158
Rated cross section		95 mm <sup>2</sup>	0000 AWG	Torque	9.25 Nm ± 0.25 81.7 lb.in ± 2.2
Rated short-time withstand current (1s)		11400 A	12840 A	Screw clamp	1.9 Nm ± 0.1 Nm 16.82 lb.in ± 0.885 lb.in
Protection		IP10	NEMA 1	Rail connection screw	
Explosive atmosphere classification		IM2 II 2 GD Ex eb III/IIIC - Class I, Zone 1, AEx e II, Ex e II U			

The connecting capacity data for one Rigid: Solid/Stranded, or one Flexible conductor (when applicable) is a mandatory information required by IEC, UL and CSA standards (Copper conductors). All other data are provided as supplementary information only. For more details, please consult our CB, UL or CSA certificates and technical datasheet available on <http://www.TE.com>



## Accessories

Description	Color	Type	Part Number	Pkg qty	Weight (1 pce)
1 End stops	Dark grey	BAZH1	1SNK900102R0000	20	24.00
2 Terminal block markers	White	MG-CPM 13 41791	1SNB041791R0612	1680	0.27
		MC812	1SNK160000R0000	22	10.00
		MC812PA	1SNK169999R0000	20	14.00
	Universal wire markers holder	Grey	UMH	1SNK900611R0000	10

Complete list of accessories is indicated in the terminal block datasheet including end stops. Some accessories such as jumper bars may modify the terminal block's ratings. Complete information available in the accessories section of the catalog.

Technical data valid for copper conductors only.

# ZS4-S screw clamp terminal blocks

Disconnect with blade - 5.2 mm 0.205 in spacing

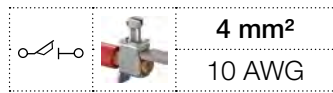

## Description

- Ease your disconnect operations with the disconnect blade operated by hand or with a screwdriver,
- Same profile as ZS4 feed-through terminal block for aligned marking and identical end section use.

## Ordering details

Description	Color	Type	Part Number	Pkg qty	Weight (1 pce) g
Disconnect Profile aligned with ZS4	Grey <input type="checkbox"/>	ZS4-S	1SNK505310R0000	50	8.60
	Blue <input type="checkbox"/>	ZS4-S-BL	1SNK505320R0000	50	8.60
	Orange <input type="checkbox"/>	ZS4-S-OR	1SNK505330R0000	50	8.60

## Main technical data

Connecting capacity		IEC	UL - CSA	Mounting instructions	
1 conductor per clamp	Rigid: Solid/Stranded	0.2 ... 4 mm <sup>2</sup>	24 ... 10 AWG	Rail	TH 35-7.5, TH 35-15
	Flexible without ferrule	0.2 ... 4 mm <sup>2</sup>		Wire stripping length	10.5 mm 0.412 in
	Flexible with non insulated ferrule	0.22 ... 4 mm <sup>2</sup>	24 ... 10 AWG		
	Flexible with insulated ferrule	0.22 ... 2.5 mm <sup>2</sup>	24 ... 14 AWG		
Gauge		A3-B3			
2 conductors per clamp	Rigid: Solid/Stranded	0.2 ... 1.5 mm <sup>2</sup>	24 ... 16 AWG	Tool	Flat screwdriver Ø 3.5 mm Ø 0.138 in
	Flexible without ferrule	0.2 ... 1.5 mm <sup>2</sup>			
	Flexible with twin ferrule	0.22 ... 1.5 mm <sup>2</sup>	24 ... 16 AWG		
Rated current / Rated cross section		25 A / 4 mm <sup>2</sup>	25 A / 10 AWG	Torque	0.6 Nm ± 0.1 5.31 lb.in ± 0.885
Rated short-time withstand current (1s)		480 A			
Rated voltage		400 V	150 V		
Impulse withstand voltage		6000 V			
Protection		IP20	NEMA 1		

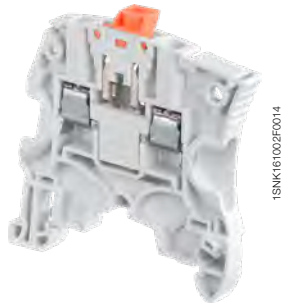

ZS4-S

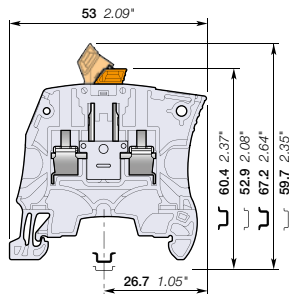

5.2 mm 0.205 in spacing

Recommendation for best usage: in horizontal assemblies, disconnect terminal blocks should be mounted with fixed foot on top (power side) so that the disconnect knife does not partially close through gravity. Furthermore, as specified per IEC 60947-7-1, disconnect terminal blocks are intended to be used for temporary disconnection at zero potential and at no load.

The connecting capacity data for one Rigid: Solid/Stranded, or one Flexible conductor (when applicable) is a mandatory information required by IEC, UL and CSA standards (Copper conductors). All other data are provided as supplementary information only. For more details, please consult our CB, UL or CSA certificates and technical datasheet available on <http://www.TE.com>

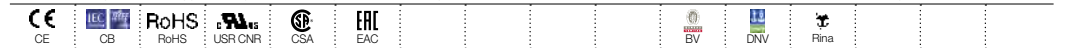

## Accessories

Description	Color	Type	Part Number	Pkg qty	Weight (1 pce) g
1 End stops 10 mm 0.394 in	Dark grey <input type="checkbox"/>	BAM4	1SNK900001R0000	50	14.00
2 End sections 2.2 mm 0.087 in	Dark grey <input type="checkbox"/>	ES4	1SNK505910R0000	20	2.20
3 Lateral jumper bars 2 poles 30 A (IEC)	Grey <input type="checkbox"/>	PC5-2	1SNA113542R1000	10	1.80
		PC5-10	1SNA113544R1200	10	6.00
4 Circuit separators 3 mm 0.118 in	Dark grey <input type="checkbox"/>	CS-R1	1SNK900103R0000	20	5.20
5 Shield connectors		SHBS	1SNK900600R0000	20	3.50
6 Protecting covers 5.2 mm 0.205 in spacing	Transparent <input checked="" type="checkbox"/>	PL5	1SNK900618R0000	10	1.50
7 Terminal block markers	White <input type="checkbox"/>	MG-CPM 13 41790	1SNB041790R0512	1960	0.23
		MC512	1SNK140000R0000	22	9.00
		MC512PA	1SNK149999R0000	20	10.00
Universal wire markers holder	Grey <input type="checkbox"/>	UMH	1SNK900611R0000	10	0.20

Complete list of accessories is indicated in the terminal block datasheet including end stops.

Some accessories such as jumper bars may modify the terminal block's ratings: Complete information available in the accessories section of the catalog.

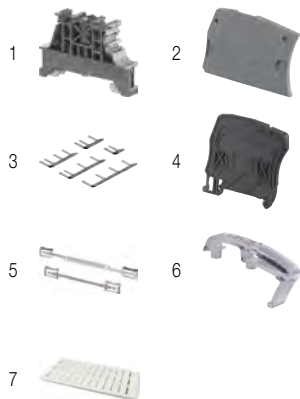

Technical data valid for copper conductors only.

# ZS4-S-T screw clamp terminal blocks

Disconnect with blade - with test socket - 5.2 mm 0.205 in spacing

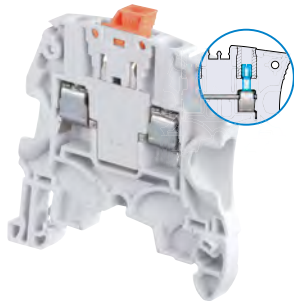
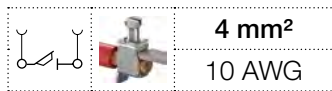

1SNK161004R0014

ZS4-S-T

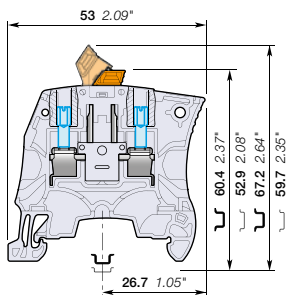

5.2 mm 0.205 in spacing

## Description

- Ease your test operations with the 2 built-in test sockets,
- Screwdriver or hand operated disconnect blade,
- Same profile as ZS4 feed-through terminal block for aligned marking and identical end section use.

## Ordering details

Description	Color	Type	Part Number	Pkg qty	Weight (1 pce) g
Disconnect Profile aligned with ZS4, with 2 test sockets DIA 2 mm 0.079 in	Grey <input type="checkbox"/>	ZS4-S-T2	1SNK505311R0000	50	8.90
	Blue <input type="checkbox"/>	ZS4-S-T2-BL	1SNK505321R0000	50	8.90
	Orange <input type="checkbox"/>	ZS4-S-T2-OR	1SNK505331R0000	50	8.90
	Grey <input type="checkbox"/>	ZS4-S-T2.3	1SNK505312R0000	50	8.80
Profile aligned with ZS4, with 2 test sockets DIA 2.3 mm 0.091 in					

## Main technical data

Connecting capacity	IEC	UL - CSA	Rail	TH 35-7.5, TH 35-15
1 conductor per clamp	Rigid: Solid/Stranded	0.2 ... 4 mm <sup>2</sup>	24 ... 10 AWG	Wire stripping length
	Flexible without ferrule	0.22 ... 4 mm <sup>2</sup>		10.5 mm 0.412 in
	Flexible with non insulated ferrule	0.22 ... 4 mm <sup>2</sup>	24 ... 10 AWG	
	Flexible with insulated ferrule	0.22 ... 2.5 mm <sup>2</sup>	24 ... 14 AWG	
Gauge	A3-B3			
2 conductors per clamp	Rigid: Solid/Stranded	0.2 ... 1.5 mm <sup>2</sup>	24 ... 16 AWG	Tool
	Flexible without ferrule	0.2 ... 1.5 mm <sup>2</sup>		Flat screwdriver Ø 3.5 mm
	Flexible with twin ferrule	0.22 ... 1.5 mm <sup>2</sup>	24 ... 16 AWG	Ø 0.138 in
Rated current / Rated cross section		25 A / 4 mm <sup>2</sup>	25 A / 10 AWG	
Rated short-time withstand current (1s)		480 A		Torque
Rated voltage		400 V	150 V	0.6 Nm ± 0.1 5.31 lb.in ± 0.885
Impulse withstand voltage		6000 V		
Protection		IP20	NEMA 1	

## Mounting instructions

Recommendation for best usage: in horizontal assemblies, disconnect terminal blocks should be mounted with fixed foot on top (power side) so that the disconnect knife does not partially close through gravity. Furthermore, as specified per IEC 60947-7-1, disconnect terminal blocks are intended to be used for temporary disconnection at zero potential and at no load.

The connecting capacity data for one Rigid: Solid/Stranded, or one Flexible conductor (when applicable) is a mandatory information required by IEC, UL and CSA standards (Copper conductors). All other data are provided as supplementary information only. For more details, please consult our CB, UL or CSA certificates and technical datasheet available on <http://www.TE.com>

CE	RoHS	UL	CSA	EAC															
----	------	----	-----	-----	--	--	--	--	--	--	--	--	--	--	--	--	--	--	--

## Accessories

Description	Color	Type	Part Number	Pkg qty	Weight (1 pce) g	
1 End stops	Dark grey	BAM4	1SNK900001R0000	50	14.00	
2 End sections	Dark grey	ES4	1SNK505910R0000	20	2.20	
3 Lateral jumper bars	Grey	2 poles	30 A (IEC)	1SNA113542R1000	10	1.80
		10 poles	30 A (IEC)	1SNA113544R1200	10	6.00
4 Circuit separators	Dark grey	CS-R1	1SNK900103R0000	20	5.20	
5 Shield connectors		SHBS	1SNK900600R0000	20	3.50	
6 Protecting covers	Transparent	3 mm	0.118 in	1SNK900618R0000	10	1.50
		5.2 mm 0.205 in spacing		PL5	1SNK900618R0000	10
7 Terminal block markers	White	Blank marker	MG-CPM 13 41790	1SNB041790R0512	1960	0.23
		Blank card	MC512	1SNK140000R0000	22	9.00
			MC512PA	1SNK149999R0000	20	10.00
		Universal wire markers holder	Grey	UMH	1SNK900611R0000	10

Complete list of accessories is indicated in the terminal block datasheet including end stops. Some accessories such as jumper bars may modify the terminal block's ratings: Complete information available in the accessories section of the catalog.



Technical data valid for copper conductors only.

# ZS4-S-R1 screw clamp terminal blocks

## Disconnect with blade - 6 mm 0.236 in spacing



1SNK161003F0014

ZS4-S-R1

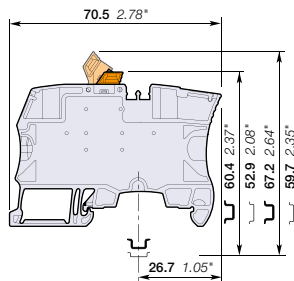

6 mm 0.236 in spacing

### Description

- Simplify the alternated distribution thanks to the two jumper channels aligned with ZS4 feed-through terminal blocks,
- Ease your disconnect operations with the disconnect blade operated by hand or with a screwdriver.

### Ordering details

Description	Color	Type	Part Number	Pkg qty	Weight (1 pce) g
Disconnect Profile aligned with ZS4-SF	Grey <input type="checkbox"/>	ZS4-S-R1	1SNK506310R0000	50	13.20
	Blue <input type="checkbox"/>	ZS4-S-R1-BL	1SNK506320R0000	50	13.20
	Orange <input type="checkbox"/>	ZS4-S-R1-OR	1SNK506330R0000	50	13.20

### Main technical data

Connecting capacity		IEC	UL - CSA	Mounting instructions	
<b>1 conductor per clamp</b>	Rigid: Solid/Stranded	0.2 ... 4 mm²	24 ... 10 AWG	Rail	TH 35-7.5, TH 35-15
	Flexible without ferrule	0.22 ... 4 mm²		Wire stripping length	10.5 mm 0.412 in
	Flexible with non insulated ferrule	0.22 ... 4 mm²	24 ... 12 AWG		
	Flexible with insulated ferrule	0.22 ... 4 mm²	24 ... 12 AWG		
	Gauge	A3-B3			
<b>2 conductors per clamp</b>	Rigid: Solid/Stranded	0.2 ... 1.5 mm²	24 ... 16 AWG	Tool	Flat screwdriver Ø 3.5 mm Ø 0.138 in
	Flexible without ferrule	0.2 ... 1.5 mm²			
	Flexible with twin ferrule	0.22 ... 1.5 mm²	24 ... 16 AWG		
<b>Rated current / Rated cross section</b>		26 A / 4 mm²	26 A / 10 AWG		
<b>Rated short-time withstand current (1s)</b>		480 A		Torque	0.6 Nm ± 0.1 5.31 lb.in ± 0.885
<b>Rated voltage</b>		400 V	150 V		
<b>Impulse withstand voltage</b>		6000 V			
<b>Protection</b>		IP20	NEMA 1		

Recommendation for best usage: in horizontal assemblies, disconnect terminal blocks should be mounted with fixed foot on top (power side) so that the disconnect knife does not partially close through gravity. Furthermore, as specified per IEC 60947-7-1, disconnect terminal blocks are intended to be used for temporary disconnection at zero potential and at no load.

The connecting capacity data for one Rigid: Solid/Stranded, or one Flexible conductor (when applicable) is a mandatory information required by IEC, UL and CSA standards (Copper conductors). All other data are provided as supplementary information only. For more details, please consult our CB, UL or CSA certificates and technical datasheet available on <http://www.TE.com>

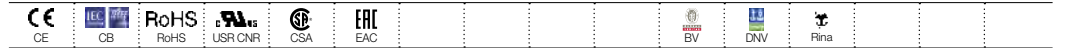

### Accessories

Description	Color	Type	Part Number	Pkg qty	Weight (1 pce) g	
<b>1 End stops</b>	Dark grey <input type="checkbox"/>	BAM4	1SNK900001R0000	50	14.00	
<b>2 Jumper bars</b>	Orange <input type="checkbox"/>	2 poles 41 A (IEC)	JB6-2	1SNK906302R0000	50	1.30
		3 poles 41 A (IEC)	JB6-3	1SNK906303R0000	50	2.10
		4 poles 41 A (IEC)	JB6-4	1SNK906304R0000	50	2.90
		5 poles 41 A (IEC)	JB6-5	1SNK906305R0000	50	3.60
		10 poles 41 A (IEC)	JB6-10	1SNK906310R0000	20	7.40
<b>3 Test adapters</b>	Dark grey <input type="checkbox"/>	For test plugs DIA 2 mm 0.079 in	TP2	1SNK900203R0000	20	1.70
		For test plugs DIA 4 mm 0.157 in	TP4	1SNK900205R0000	20	2.40
<b>4 Test connectors</b>	Dark grey <input type="checkbox"/>	TC5-R1	1SNK900201R0000	10	5.20	
<b>5 Spacers</b>	Dark grey <input type="checkbox"/>	ES-TC6	1SNK900105R0000	10	0.80	
<b>6 Terminal block markers</b>	White <input type="checkbox"/>	Blank marker	MG-CPM 13 41791	1SNB041791R0612	1680	0.27
		Blank card	MC612	1SNK150000R0000	22	10.00
			MC612PA	1SNK159999R0000	20	11.00
		Universal wire markers holder	Grey <input type="checkbox"/>	UMH	1SNK900611R0000	10

Complete list of accessories is indicated in the terminal block datasheet including end stops. Some accessories such as jumper bars may modify the terminal block's ratings: Complete information available in the accessories section of the catalog.

Technical data valid for copper conductors only.

# ZS4-S-T-R1 screw clamp terminal blocks

Disconnect with blade - with test socket - 6 mm 0.236 in spacing

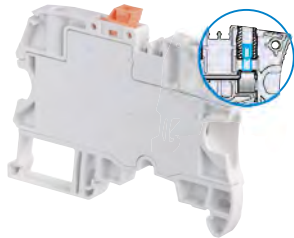

ZS4-S-T-R1

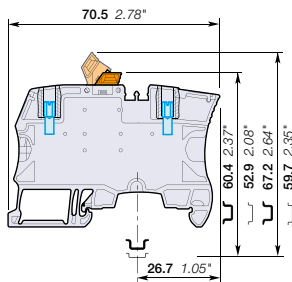

6 mm 0.236 in spacing

## Description

- Ease your test operations with the 2 built-in test sockets,
- Screwdriver or hand operated disconnect blade,
- Simplify the alternated distribution thanks to the two jumper channels aligned with ZS4 feed-through terminal blocks.

## Ordering details

Description	Color	Type	Part Number	Pkg qty	Weight (1 pce) g
Disconnect Profile aligned with ZS4-SF, with 2 test sockets DIA 2 mm 0.079 in	Grey	ZS4-S-T2-R1	1SNK506311R0000	50	14.20
	Blue	ZS4-S-T2-R1-BL	1SNK506321R0000	50	14.20
Profile aligned with ZS4-SF, with 2 test sockets DIA 2.3 mm 0.091 in	Orange	ZS4-S-T2-R1-OR	1SNK506331R0000	50	14.20
	Grey	ZS4-S-T2.3-R1	1SNK506312R0000	50	14.20

## Main technical data

Connecting capacity	IEC	UL - CSA	Rail	TH 35-7.5, TH 35-15	
1 conductor per clamp	Rigid: Solid/Stranded	0.2 ... 4 mm²	24 ... 10 AWG	Wire stripping length	10.5 mm 0.412 in
	Flexible without ferrule	0.22 ... 4 mm²			
	Flexible with non insulated ferrule	0.22 ... 4 mm²	24 ... 12 AWG		
	Flexible with insulated ferrule	0.22 ... 4 mm²	24 ... 12 AWG		
2 conductors per clamp	Rigid: Solid/Stranded	0.2 ... 1.5 mm²	24 ... 16 AWG	Tool	Flat screwdriver Ø 3.5 mm Ø 0.138 in
	Flexible without ferrule	0.22 ... 1.5 mm²	24 ... 16 AWG		
Rated current / Rated cross section		26 A / 4 mm²	26 A / 10 AWG	Torque	0.6 Nm ± 0.1 5.31 lb.in ± 0.885
Rated short-time withstand current (1s)		480 A			
Rated voltage		400 V	150 V		
Impulse withstand voltage		6000 V			
Protection		IP20	NEMA 1		

Recommendation for best usage: in horizontal assemblies, disconnect terminal blocks should be mounted with fixed foot on top (power side) so that the disconnect knife does not partially close through gravity. Furthermore, as specified per IEC 60947-7-1, disconnect terminal blocks are intended to be used for temporary disconnection at zero potential and at no load.

The connecting capacity data for one Rigid: Solid/Stranded, or one Flexible conductor (when applicable) is a mandatory information required by IEC, UL and CSA standards (Copper conductors). All other data are provided as supplementary information only. For more details, please consult our CB, UL or CSA certificates and technical datasheet available on <http://www.TE.com>

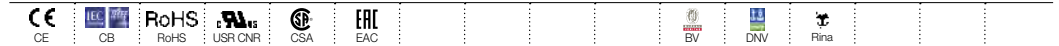

## Accessories

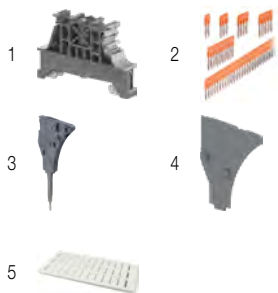

Description	Color	Type	Part Number	Pkg qty	Weight (1 pce) g	
1 End stops	Dark grey	BAM4	1SNK900001R0000	50	14.00	
2 Jumper bars	Orange	2 poles	JB6-2	1SNK906302R0000	50	1.30
		3 poles	JB6-3	1SNK906303R0000	50	2.10
		4 poles	JB6-4	1SNK906304R0000	50	2.90
		5 poles	JB6-5	1SNK906305R0000	50	3.60
		10 poles	JB6-10	1SNK906310R0000	20	7.40
3 Test connectors	Dark grey	TC5-R1	1SNK900201R0000	10	5.20	
4 Spacers	Dark grey	ES-TC6	1SNK900105R0000	10	0.80	
5 Terminal block markers	White	Blank marker	MG-CPM 13 41791	1680	0.27	
		Blank card	MC612	1SNK150000R0000	22	10.00
			MC612PA	1SNK159999R0000	20	11.00
	Universal wire markers holder	Grey	UMH	1SNK900611R0000	10	0.20

Complete list of accessories is indicated in the terminal block datasheet including end stops. Some accessories such as jumper bars may modify the terminal block's ratings: Complete information available in the accessories section of the catalog.

Technical data valid for copper conductors only.



# ZS6-S screw clamp terminal blocks

## Disconnect with blade - 6 mm 0.236 in spacing

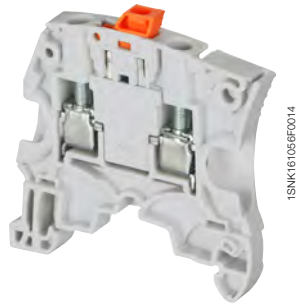
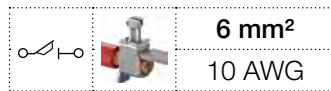

ZS6-S

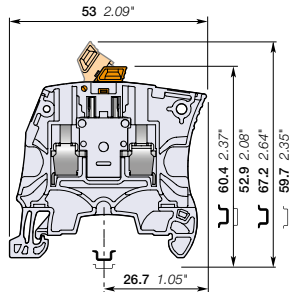

6 mm 0.236 in spacing

### Description

- Ease your disconnect operations with the disconnect blade operated by hand or with a screwdriver,
- Same profile as ZS6 feed-through terminal block for aligned marking and identical end section use.

### Ordering details

Description	Color	Type	Part Number	Pkg qty	Weight (1 pce) g
Disconnect Profile aligned with ZS6	Grey <input type="checkbox"/>	ZS6-S	1SNK506315R0000	50	8.60
	Blue <input type="checkbox"/>	ZS6-S-BL	1SNK506322R0000	50	8.60

### Main technical data

Connecting capacity		IEC	UL - CSA	Rail	TH 35-7.5, TH 35-15
1 conductor per clamp	Rigid: Solid/Stranded	0.2 ... 6 mm <sup>2</sup>	24 ... 10 AWG	Wire stripping length	10.5 mm 0.412 in
	Flexible without ferrule	0.22 ... 6 mm <sup>2</sup>			
	Flexible with non insulated ferrule	0.22 ... 6 mm <sup>2</sup>	24 ... 12 AWG		
	Flexible with insulated ferrule	0.22 ... 4 mm <sup>2</sup>	24 ... 12 AWG		
Gauge		A4-B3			
2 conductors per clamp	Rigid: Solid/Stranded	0.2 ... 2.5 mm <sup>2</sup>	24 ... 14 AWG	Tool	Flat screwdriver Ø 4 mm Ø 0.157 in
	Flexible without ferrule	0.22 ... 2.5 mm <sup>2</sup>			
	Flexible with twin ferrule	0.22 ... 2.5 mm <sup>2</sup>	24 ... 14 AWG		
Rated current / Rated cross section		25 A / 4 mm <sup>2</sup>	25 A / 10 AWG		
Maximum current / Maximum cross section		30 A / 6 mm <sup>2</sup>			
Rated short-time withstand current (1s)		480 A		Torque	0.85 Nm ± 0.15 7.52 lb.in ± 1.33
Rated voltage		500 V	300 V		
Impulse withstand voltage		6000 V			
Protection		IP20	NEMA 1		

Recommendation for best usage: in horizontal assemblies, disconnect terminal blocks should be mounted with fixed foot on top (power side) so that the disconnect knife does not partially close through gravity. Furthermore, as specified per IEC 60947-7-1, disconnect terminal blocks are intended to be used for temporary disconnection at zero potential and at no load.

The connecting capacity data for one Rigid: Solid/Stranded, or one Flexible conductor (when applicable) is a mandatory information required by IEC, UL and CSA standards (Copper conductors). All other data are provided as supplementary information only. For more details, please consult our CB, UL or CSA certificates and technical datasheet available on <http://www.TE.com>



### Accessories

Description	Color	Type	Part Number	Pkg qty	Weight (1 pce) g
1 End stops 10 mm 0.394 in	Dark grey <input checked="" type="checkbox"/>	BAM4	1SNK900001R0000	50	14.00
2 End sections 2.2 mm 0.087 in	Dark grey <input checked="" type="checkbox"/>	ES4	1SNK505910R0000	20	2.20
3 Circuit separators 3 mm 0.118 in	Dark grey <input checked="" type="checkbox"/>	CS-R1	1SNK900103R0000	20	5.20
4 Shield connectors		SHBS	1SNK900600R0000	20	3.50
5 Protecting covers 6 mm 0.236 in spacing	Transparent <input checked="" type="checkbox"/>	PL6	1SNK900619R0000	10	1.80
6 Terminal block markers	White <input type="checkbox"/>	MG-CPM 13 41791	1SNB041791R0612	1680	0.27
		MC612	1SNK150000R0000	22	10.00
		MC612PA	1SNK159999R0000	20	11.00
Universal wire markers holder	Grey <input type="checkbox"/>	UMH	1SNK900611R0000	10	0.20

Complete list of accessories is indicated in the terminal block datasheet including end stops.

Some accessories such as jumper bars may modify the terminal block's ratings: Complete information available in the accessories section of the catalog.



Technical data valid for copper conductors only.

# ZS6-S-4S-T screw clamp terminal blocks

Disconnect with blade - with test socket screws - 6 mm 0.236 in spacing

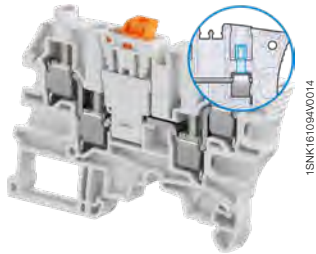

ZS6-S-4S-T

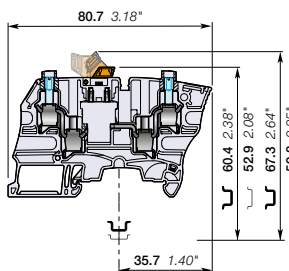

6 mm 0.236 in spacing

## Description

- Recommended for energy markets and highly demanding applications requiring that only one conductor be connected per clamp,
- Ease your disconnect and test operations with the two built-in test socket screws,
- Simplify the alternated distribution thanks to the jumper channel.

## Ordering details

Description	Color	Type	Part Number	Pkg qty	Weight (1 pce)
Disconnect with 2 test sockets DIA 2 mm 0,079 in	Grey <input type="checkbox"/>	ZS6-S-4S-T2	1SNK506316R0000	50	18.40

## Main technical data

Connecting capacity		IEC	UL - CSA	Mounting instructions	
1 conductor per clamp	Rigid: Solid/Stranded	0.2 ... 6 mm <sup>2</sup>	24 ... 10 AWG	Rail	TH 35-7.5, TH 35-15
	Flexible without ferrule	0.22 ... 6 mm <sup>2</sup>		Wire stripping length	10.5 mm 0.413 in
	Flexible with non insulated ferrule	0.22 ... 4 mm <sup>2</sup>	24 ... 12 AWG		
	Flexible with insulated ferrule	0.22 ... 4 mm <sup>2</sup>	24 ... 12 AWG		
Gauge		A4-B3		Tool	Flat screwdriver Ø 4 mm Ø 0.157 in
2 conductors per clamp	Rigid: Solid/Stranded	0.2 ... 2.5 mm <sup>2</sup>	24 ... 14 AWG		
	Flexible without ferrule	0.2 ... 2.5 mm <sup>2</sup>			
	Flexible with twin ferrule	0.22 ... 2.5 mm <sup>2</sup>	24 ... 14 AWG		
Rated current / Rated cross section		27 A / 4 mm <sup>2</sup>	28 A / 10 AWG	Torque	0.85 Nm ± 0.15 7.52 lb.in ± 1.33
Rated short-time withstand current (1s)		480 A			
Rated voltage		500 V	300 V		
Impulse withstand voltage		6000 V			
Protection		IP20	NEMA 1		

Recommendation for best usage: in horizontal assemblies, disconnect terminal blocks should be mounted with fixed foot on top (power side) so that the disconnect knife does not partially close through gravity. Furthermore, as specified per IEC 60947-7-1, disconnect terminal blocks are intended to be used for temporary disconnection at zero potential and at no load.

The connecting capacity data for one Rigid: Solid/Stranded, or one Flexible conductor (when applicable) is a mandatory information required by IEC, UL and CSA standards (Copper conductors). All other data are provided as supplementary information only. For more details, please consult our CB, UL or CSA certificates and technical datasheet available on <http://www.TE.com>



## Accessories



Description	Color	Type	Part Number	Pkg qty	Weight (1 pce)	
1 End stops	Dark grey <input type="checkbox"/>	BAM4	1SNK900001R0000	50	14.00	
2 End sections	Dark grey <input type="checkbox"/>	ES6-4S	1SNK505911R0000	20	3.10	
3 Jumper bars	Orange <input type="checkbox"/>	2 poles	1SNK906302R0000	50	1.30	
		3 poles	1SNK906303R0000	50	2.10	
		4 poles	1SNK906304R0000	50	2.90	
		5 poles	1SNK906305R0000	50	3.60	
		10 poles	1SNK906310R0000	20	7.40	
4 Circuit separators	Dark grey <input type="checkbox"/>	CS-R1	1SNK900103R0000	20	5.20	
5 Test adapters	Dark grey <input type="checkbox"/>	For test plugs DIA 2 mm 0.079 in	1SNK900203R0000	20	1.70	
		For test plugs DIA 4 mm 0.157 in	1SNK900205R0000	20	2.40	
6 Test connectors	Dark grey <input type="checkbox"/>	TC5-R1	1SNK900201R0000	10	5.20	
7 Spacers	Dark grey <input type="checkbox"/>	ES-TC6	1SNK900105R0000	10	0.80	
8 Terminal block markers	White <input type="checkbox"/>	Blank marker	1SNB041791R0612	1680	0.27	
		Blank card	MC612	1SNK150000R0000	22	10.00
			MC612PA	1SNK159999R0000	20	11.00
			Universal wire markers holder	Grey <input type="checkbox"/>	UMH	1SNK900611R0000

Complete list of accessories is indicated in the terminal block datasheet including end stops. Some accessories such as jumper bars may modify the terminal block's ratings: Complete information available in the accessories section of the catalog.

Technical data valid for copper conductors only.

# ZS10-S screw clamp terminal blocks

## Disconnect with blade - 8 mm 0.315 in spacing

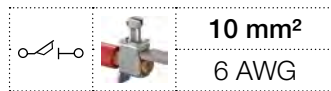

1SNK161058F0014

ZS10-S

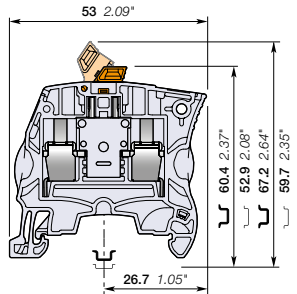

8 mm 0.315 in spacing

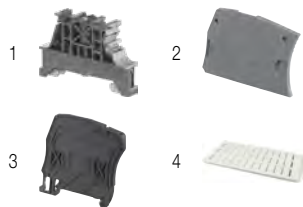

### Description

- Ease your disconnect operations with the disconnect blade operated by hand or with a screwdriver,
- Same profile as ZS10 feed-through terminal block for aligned marking and identical end section use.

### Ordering details

Description	Color	Type	Part Number	Pkg qty	Weight (1 pce) g
Disconnect Profile aligned with ZS10	Grey <input type="checkbox"/>	ZS10-S	1SNK508315R0000	50	8.60
	Blue <input type="checkbox"/>	ZS10-S-BL	1SNK508320R0000	50	8.60

### Main technical data

Connecting capacity	IEC	UL - CSA	Rail	Wire stripping length	TH 35-7.5, TH 35-15
1 conductor per clamp	Rigid: Solid/Stranded	0.2 ... 10 mm <sup>2</sup>	24 ... 6 AWG	12 mm 0.472 in	
	Flexible without ferrule	0.22 ... 10 mm <sup>2</sup>			
	Flexible with non insulated ferrule	0.22 ... 10 mm <sup>2</sup>	24 ... 12 AWG		
	Flexible with insulated ferrule	0.22 ... 6 mm <sup>2</sup>	24 ... 12 AWG		
Gauge	A5-B5				
2 conductors per clamp	Rigid: Solid/Stranded	0.5 ... 4 mm <sup>2</sup>	20 ... 12 AWG	Tool	Flat screwdriver Ø 4 mm Ø 0.157 in
	Flexible without ferrule	0.5 ... 4 mm <sup>2</sup>			
	Flexible with twin ferrule	0.5 ... 4 mm <sup>2</sup>	20 ... 12 AWG		
Rated current / Rated cross section	25 A / 4 mm <sup>2</sup>	25 A / 6 AWG			
Maximum current / Maximum cross section	42 A / 10 mm <sup>2</sup>				
Rated short-time withstand current (1s)	480 A			Torque	1.3 Nm ± 0.3 11.5 lb.in ± 2.65
Rated voltage	630 V	300 V			
Impulse withstand voltage	6000 V				
Protection	IP20	NEMA 1			

Recommendation for best usage: in horizontal assemblies, disconnect terminal blocks should be mounted with fixed foot on top (power side) so that the disconnect knife does not partially close through gravity. Furthermore, as specified per IEC 60947-7-1, disconnect terminal blocks are intended to be used for temporary disconnection at zero potential and at no load.

The connecting capacity data for one Rigid: Solid/Stranded, or one Flexible conductor (when applicable) is a mandatory information required by IEC, UL and CSA standards (Copper conductors). All other data are provided as supplementary information only. For more details, please consult our CB, UL or CSA certificates and technical datasheet available on <http://www.TE.com>



### Accessories

Description	Color	Type	Part Number	Pkg qty	Weight (1 pce) g
1 End stops	Dark grey <input checked="" type="checkbox"/>	BAM4	1SNK900001R0000	50	14.00
2 End sections	Dark grey <input checked="" type="checkbox"/>	ES4	1SNK505910R0000	20	2.20
3 Circuit separators	Dark grey <input checked="" type="checkbox"/>	CS-R1	1SNK900103R0000	20	5.20
4 Terminal block markers	White <input type="checkbox"/>	MG-CPM 13 41791	1SNB041791R0612	1680	0.27
		MC812	1SNK160000R0000	22	10.00
		MC812PA	1SNK169999R0000	20	14.00
Universal wire markers holder	Grey <input type="checkbox"/>	UMH	1SNK900611R0000	10	0.20

Complete list of accessories is indicated in the terminal block datasheet including end stops.

Some accessories such as jumper bars may modify the terminal block's ratings: Complete information available in the accessories section of the catalog.

Technical data valid for copper conductors only.

# ZS4-SP screw clamp terminal blocks

## Disconnect with plug - 5.2 mm 0.205 in spacing

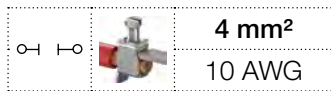

ZS4-SP

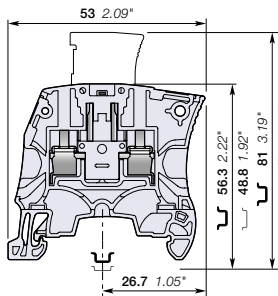

5.2 mm 0.205 in spacing

### Description

- Save time with our screwless component holder plug,
- Same profile as ZS4 feed-through terminal block for aligned marking and identical end section use.

### Ordering details

Description	Color	Type	Part Number	Pkg qty	Weight (1 pce)
Disconnect Profile aligned with ZS4, plug delivered separately	Grey <input type="checkbox"/>	ZS4-SP	1SNK505313R0000	50	8.20

### Main technical data

Connecting capacity		IEC	UL - CSA	Mounting instructions	
1 conductor per clamp	Rigid: Solid/Stranded	0.2 ... 4 mm <sup>2</sup>	24 ... 10 AWG	Rail	TH 35-7.5, TH 35-15
	Flexible without ferrule	0.22 ... 4 mm <sup>2</sup>		Wire stripping length	10.5 mm 0.412 in
	Flexible with non insulated ferrule	0.22 ... 4 mm <sup>2</sup>	24 ... 10 AWG	Tool	Flat screwdriver Ø 3.5 mm Ø 0.138 in
	Flexible with insulated ferrule	0.22 ... 2.5 mm <sup>2</sup>	24 ... 14 AWG		
Gauge		A3-B3		Torque	0.6 Nm ± 0.1 5.31 lb.in ± 0.885
2 conductors per clamp	Rigid: Solid/Stranded	0.2 ... 1.5 mm <sup>2</sup>	24 ... 16 AWG		
	Flexible without ferrule	0.2 ... 1.5 mm <sup>2</sup>	24 ... 16 AWG		
Flexible with twin ferrule		0.22 ... 1.5 mm <sup>2</sup>	24 ... 16 AWG		
Rated current / Rated cross section		18 A / 2.5 mm <sup>2</sup>	18 A / 10 AWG		
Rated short-time withstand current (1s)		300 A			
Rated voltage		400 V	150 V		
Impulse withstand voltage		6000 V			
Protection		IP20	NEMA 1		

The connecting capacity data for one Rigid: Solid/Stranded, or one Flexible conductor (when applicable) is a mandatory information required by IEC, UL and CSA standards (Copper conductors). All other data are provided as supplementary information only. For more details, please consult our CB, UL or CSA certificates and technical datasheet available on <http://www.TE.com>

CE	RoHS	UL	CSA	EAC

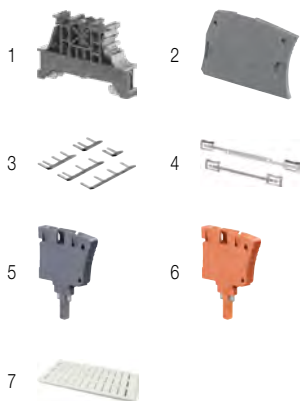

### Accessories

Description	Color	Type	Part Number	Pkg qty	Weight (1 pce)
1 End stops 10 mm 0.394 in	Dark grey <input checked="" type="checkbox"/>	BAM4	1SNK900001R0000	50	14.00
2 End sections 2.2 mm 0.087 in	Dark grey <input checked="" type="checkbox"/>	ES4	1SNK505910R0000	20	2.20
3 Lateral jumper bars 2 poles 30 A (IEC)	Grey <input type="checkbox"/>	PC5-2	1SNA113542R1000	10	1.80
		PC5-10	1SNA113544R1200	10	6.00
4 Shield connectors		SHBS	1SNK900600R0000	20	3.50
5 Component plugs Components in series with circuit	Dark grey <input checked="" type="checkbox"/>	PG5	1SNK900401R0000	20	3.50
6 Disconnect plugs Equipped with linking bar	Orange <input checked="" type="checkbox"/>	PG5-R1	1SNK900402R0000	20	3.50
7 Terminal block markers	White <input type="checkbox"/>	MG-CPM 13 41790	1SNB041790R0512	1960	0.23
		MC512	1SNK140000R0000	22	9.00
		MC512PA	1SNK149999R0000	20	10.00
Universal wire markers holder	Grey <input type="checkbox"/>	UMH	1SNK900611R0000	10	0.20

Complete list of accessories is indicated in the terminal block datasheet including end stops. Some accessories such as jumper bars may modify the terminal block's ratings: Complete information available in the accessories section of the catalog.

Technical data valid for copper conductors only.

# ZS4-SP-T2 screw clamp terminal blocks

Disconnect with plug - with test socket - 5.2 mm 0.205 in spacing

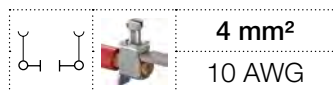

ZS4-SP-T2

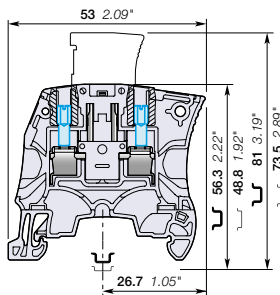

5.2 mm 0.205 in spacing

## Description

- Ease your test operations with the 2 built-in test sockets DIA 2 mm 0.079 in,
- Save time with our screwless component holder plug,
- Same profile as ZS4 feed-through terminal block for aligned marking and identical end section use.

## Ordering details

Description	Color	Type	Part Number	Pkg qty	Weight (1 pce)
Disconnect Profile aligned with ZS4, with 2 test sockets DIA 2 mm 0.079 in, plug delivered separately	Grey <input type="checkbox"/>	ZS4-SP-T2	1SNK505314R0000	50	8.40 g

## Main technical data

Connecting capacity		IEC	UL - CSA	Mounting instructions	
1 conductor per clamp	Rigid: Solid/Stranded	0.2 ... 4 mm <sup>2</sup>	24 ... 10 AWG	Rail	TH 35-7.5, TH 35-15
	Flexible without ferrule	0.22 ... 4 mm <sup>2</sup>		Wire stripping length	10.5 mm 0.412 in
	Flexible with non insulated ferrule	0.22 ... 4 mm <sup>2</sup>	24 ... 10 AWG		
	Flexible with insulated ferrule	0.22 ... 2.5 mm <sup>2</sup>	24 ... 14 AWG		
	Gauge	A3-B3			
2 conductors per clamp	Rigid: Solid/Stranded	0.2 ... 1.5 mm <sup>2</sup>	24 ... 16 AWG	Tool	Flat screwdriver Ø 3.5 mm Ø 0.138 in
	Flexible without ferrule	0.2 ... 1.5 mm <sup>2</sup>	24 ... 16 AWG		
	Flexible with twin ferrule	0.22 ... 1.5 mm <sup>2</sup>	24 ... 16 AWG		
Rated current / Rated cross section		18 A / 2.5 mm <sup>2</sup>	18 A / 10 AWG	Torque	0.6 Nm ± 0.1 5.31 lb.in ± 0.885
Rated short-time withstand current (1s)		300 A			
Rated voltage		400 V	150 V		
Impulse withstand voltage		6000 V			
Protection		IP20	NEMA 1		

The connecting capacity data for one Rigid: Solid/Stranded, or one Flexible conductor (when applicable) is a mandatory information required by IEC, UL and CSA standards (Copper conductors). All other data are provided as supplementary information only. For more details, please consult our CB, UL or CSA certificates and technical datasheet available on <http://www.TE.com>

CE	RoHS	UL	CSA	EAC

## Accessories

Description	Color	Type	Part Number	Pkg qty	Weight (1 pce)
1 End stops 10 mm 0.394 in	Dark grey <input checked="" type="checkbox"/>	BAM4	1SNK900001R0000	50	14.00 g
2 End sections 2.2 mm 0.087 in	Dark grey <input checked="" type="checkbox"/>	ES4	1SNK505910R0000	20	2.20 g
3 Lateral jumper bars 2 poles 30 A (IEC)	Grey <input type="checkbox"/>	PC5-2	1SNA113542R1000	10	1.80 g
		PC5-10	1SNA113544R1200	10	6.00 g
4 Shield connectors		SHBS	1SNK900600R0000	20	3.50 g
5 Component plugs Components in series with circuit	Dark grey <input checked="" type="checkbox"/>	PG5	1SNK900401R0000	20	3.50 g
6 Disconnect plugs Equipped with linking bar	Orange <input checked="" type="checkbox"/>	PG5-R1	1SNK900402R0000	20	3.50 g
7 Terminal block markers	White <input type="checkbox"/>	MG-CPM 13 41790	1SNB041790R0512	1960	0.23 g
		MC512	1SNK140000R0000	22	9.00 g
		MC512PA	1SNK149999R0000	20	10.00 g
		Universal wire markers holder	Grey <input type="checkbox"/>	UMH	1SNK900611R0000

Complete list of accessories is indicated in the terminal block datasheet including end stops. Some accessories such as jumper bars may modify the terminal block's ratings. Complete information available in the accessories section of the catalog.



Technical data valid for copper conductors only.



# ZS4-SP-R1 screw clamp terminal blocks

## Disconnect with plug - 6 mm 0.236 in spacing

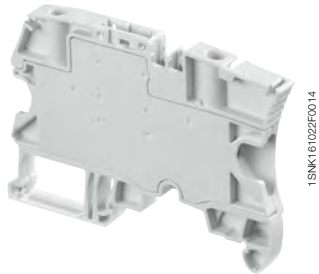
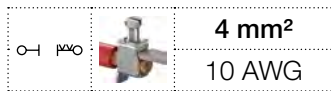

ZS4-SP-R1

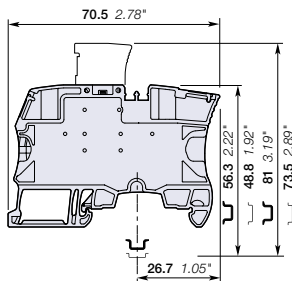

6 mm 0.236 in spacing

### Description

- Simplify the alternated distribution between feed-through and disconnect circuits thanks to the two aligned jumper channels,
- Save time with our screwless component holder plug.

### Ordering details

Description	Color	Type	Part Number	Pkg qty	Weight (1 pce) g
Disconnect Profile aligned with ZS4-SF, plug delivered separately	Grey <input type="checkbox"/>	ZS4-SP-R1	1SNK506313R0000	50	14.20

### Main technical data

Connecting capacity		IEC	UL - CSA	Mounting instructions	
1 conductor per clamp	Rigid: Solid/Stranded	0.2 ... 4 mm²	24 ... 10 AWG	Rail	TH 35-7.5, TH 35-15
	Flexible without ferrule	0.22 ... 4 mm²		Wire stripping length	10.5 mm 0.412 in
	Flexible with non insulated ferrule	0.22 ... 4 mm²	24 ... 12 AWG	Tool	Flat screwdriver Ø 3.5 mm Ø 0.138 in
	Flexible with insulated ferrule	0.22 ... 4 mm²	24 ... 12 AWG		
	Gauge	A3-B3			
2 conductors per clamp	Rigid: Solid/Stranded	0.2 ... 1.5 mm²	24 ... 16 AWG	Torque	0.6 Nm ± 0.1 5.31 lb.in ± 0.885
	Flexible without ferrule	0.2 ... 1.5 mm²			
	Flexible with twin ferrule	0.22 ... 1.5 mm²	24 ... 16 AWG		
Rated current / Rated cross section		18 A / 2.5 mm²	20 A / 10 AWG		
Rated short-time withstand current (1s)		300 A			
Rated voltage		400 V	150 V		
Impulse withstand voltage		6000 V			
Protection		IP20	NEMA 1		

The connecting capacity data for one Rigid: Solid/Stranded, or one Flexible conductor (when applicable) is a mandatory information required by IEC, UL and CSA standards (Copper conductors). All other data are provided as supplementary information only. For more details, please consult our CB, UL or CSA certificates and technical datasheet available on <http://www.TE.com>

--	--	--	--	--

### Accessories

Description	Color	Type	Part Number	Pkg qty	Weight (1 pce) g
1 End stops	Dark grey <input type="checkbox"/>	BAM4	1SNK900001R0000	50	14.00
2 Jumper bars	Orange <input type="checkbox"/>	JB6-2	1SNK906302R0000	50	1.30
		JB6-3	1SNK906303R0000	50	2.10
		JB6-4	1SNK906304R0000	50	2.90
		JB6-5	1SNK906305R0000	50	3.60
		JB6-10	1SNK906310R0000	20	7.40
3 Test adapters	Dark grey <input type="checkbox"/>	TP2	1SNK900203R0000	20	1.70
		TP4	1SNK900205R0000	20	2.40
4 Test connectors	Dark grey <input type="checkbox"/>	TC5-R1	1SNK900201R0000	10	5.20
5 Spacers	Dark grey <input type="checkbox"/>	ES-TC6	1SNK900105R0000	10	0.80
6 Component plugs	Dark grey <input type="checkbox"/>	PG5	1SNK900401R0000	20	3.50
7 Disconnect plugs	Orange <input type="checkbox"/>	PG5-R1	1SNK900402R0000	20	3.50
8 Terminal block markers	White <input type="checkbox"/>	MG-CPM 13 41791	1SNB041791R0612	1680	0.27
		MC612	1SNK150000R0000	22	10.00
		MC612PA	1SNK159999R0000	20	11.00
	Grey <input type="checkbox"/>	UMH	1SNK900611R0000	10	0.20

Complete list of accessories is indicated in the terminal block datasheet including end stops. Some accessories such as jumper bars may modify the terminal block's ratings: Complete information available in the accessories section of the catalog.

Technical data valid for copper conductors only.

# ZS4-SP-T2-R1 screw clamp terminal blocks

Disconnect with plug - with test socket - 6 mm 0.236 in spacing

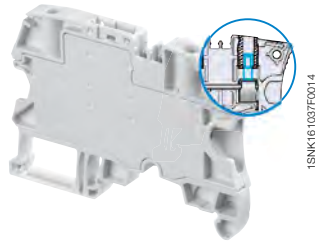
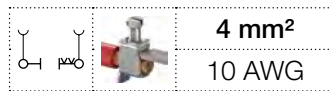

## Description

- Ease your test operations with the 2 built-in test sockets DIA 2 mm 0.079 in,
- Save time with our screwless component holder plug,
- Simplify the distribution between feed-through and disconnect circuits thanks to the two aligned jumper channels.

## Ordering details

Description	Color	Type	Part Number	Pkg qty	Weight (1 pce)
Disconnect Profile aligned with ZS4-SF, with 2 test sockets DIA 2 mm 0.079 in, plug delivered separately	Grey <input type="checkbox"/>	ZS4-SP-T2-R1	1SNK506314R0000	50	14.20 g

## Main technical data

Connecting capacity		IEC	UL - CSA	Mounting instructions	
1 conductor per clamp	Rigid: Solid/Stranded	0.2 ... 4 mm²	24 ... 10 AWG	Rail	TH 35-7.5, TH 35-15
	Flexible without ferrule	0.22 ... 4 mm²		Wire stripping length	10.5 mm 0.412 in
	Flexible with non insulated ferrule	0.22 ... 4 mm²	24 ... 12 AWG		
	Flexible with insulated ferrule	0.22 ... 4 mm²	24 ... 12 AWG		
Gauge		A3-B3			
2 conductors per clamp	Rigid: Solid/Stranded	0.2 ... 1.5 mm²	24 ... 16 AWG	Tool	Flat screwdriver Ø 3.5 mm Ø 0.138 in
	Flexible without ferrule	0.2 ... 1.5 mm²			
	Flexible with twin ferrule	0.22 ... 1.5 mm²	24 ... 16 AWG		
Rated current / Rated cross section		18 A / 2.5 mm²	20 A / 10 AWG		
Rated short-time withstand current (1s)		300 A		Torque	0.6 Nm ± 0.1 5.31 lb.in ± 0.85
Rated voltage		400 V	150 V		
Impulse withstand voltage		6000 V			
Protection		IP20	NEMA 1		

ZS4-SP-T2-R1

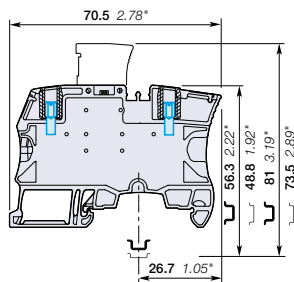

6 mm 0.236 in spacing

The connecting capacity data for one Rigid: Solid/Stranded, or one Flexible conductor (when applicable) is a mandatory information required by IEC, UL and CSA standards (Copper conductors). All other data are provided as supplementary information only. For more details, please consult our CB, UL or CSA certificates and technical datasheet available on <http://www.TE.com>

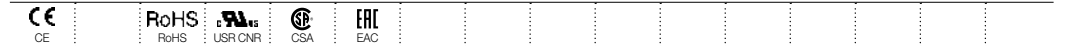

## Accessories

Description	Color	Type	Part Number	Pkg qty	Weight (1 pce)	
1 End stops	Dark grey <input checked="" type="checkbox"/>	BAM4	1SNK900001R0000	50	14.00	
2 Jumper bars	Orange <input checked="" type="checkbox"/>	2 poles	JB6-2	1SNK906302R0000	50	1.30
		3 poles	JB6-3	1SNK906303R0000	50	2.10
		4 poles	JB6-4	1SNK906304R0000	50	2.90
		5 poles	JB6-5	1SNK906305R0000	50	3.60
		10 poles	JB6-10	1SNK906310R0000	20	7.40
3 Test connectors	Dark grey <input checked="" type="checkbox"/>	TC5-R1	1SNK900201R0000	10	5.20	
4 Spacers	Dark grey <input checked="" type="checkbox"/>	ES-TC6	1SNK900105R0000	10	0.80	
5 Component plugs	Dark grey <input checked="" type="checkbox"/>	PG5	1SNK900401R0000	20	3.50	
6 Disconnect plugs	Orange <input checked="" type="checkbox"/>	PG5-R1	1SNK900402R0000	20	3.50	
7 Terminal block markers	White <input type="checkbox"/>	Blank marker	MG-CPM 13 41791	1SNB041791R0612	1680	0.27
		Blank card	MC612	1SNK150000R0000	22	10.00
			MC612PA	1SNK159999R0000	20	11.00
		Universal wire markers holder	Grey <input type="checkbox"/>	UMH	1SNK900611R0000	10

Complete list of accessories is indicated in the terminal block datasheet including end stops. Some accessories such as jumper bars may modify the terminal block's ratings: Complete information available in the accessories section of the catalog.



Technical data valid for copper conductors only.

# ZS10-SP screw clamp terminal blocks

Disconnect with plug - 8 mm 0.315 in spacing

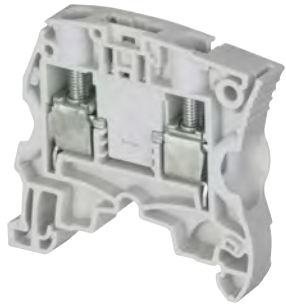

ZS10-SP

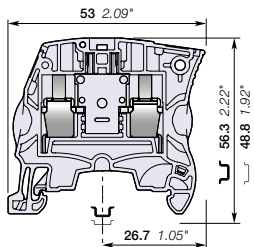

8 mm 0.315 in spacing

## Description

- Save time with our screwless component holder plug,
- Same profile as ZS10 feed-through terminal block for aligned marking and identical end section use.

## Ordering details

Description	Color	Type	Part Number	Pkg qty	Weight (1 pce) g
Disconnect Profile aligned with ZS10	Grey <input type="checkbox"/>	ZS10-SP	1SNK508316R0000	50	8.60

## Main technical data

Connecting capacity		IEC	UL - CSA	Mounting instructions	
1 conductor per clamp	Rigid: Solid/Stranded	0.2 ... 10 mm <sup>2</sup>	24 ... 6 AWG	Rail	TH 35-7.5, TH 35-15
	Flexible without ferrule	0.22 ... 10 mm <sup>2</sup>	24 ... 8 AWG	Wire stripping length	12 mm 0.472 in
	Flexible with non insulated ferrule	0.22 ... 10 mm <sup>2</sup>	24 ... 8 AWG	Tool	Flat screwdriver Ø 4 mm Ø 0.157 in
	Flexible with insulated ferrule	0.22 ... 6 mm <sup>2</sup>	24 ... 8 AWG		
Gauge		A5-B5			
2 conductors per clamp	Rigid: Solid/Stranded	0.5 ... 4 mm <sup>2</sup>	20 ... 12 AWG	Torque	1.3 Nm ± 0.3 11.5 lb.in ± 2.65
	Flexible without ferrule	0.5 ... 4 mm <sup>2</sup>	20 ... 12 AWG		
	Flexible with twin ferrule	0.5 ... 4 mm <sup>2</sup>	20 ... 12 AWG		
Rated current / Rated cross section		18 A / 2.5 mm <sup>2</sup>	18 A / 6 AWG		
Maximum current / Maximum cross section		18 A / 10 mm <sup>2</sup>			
Rated short-time withstand current (1s)		300 A			
Rated voltage		630 V	300 V		
Impulse withstand voltage		6000 V			
Protection		IP20	NEMA 1		

The connecting capacity data for one Rigid: Solid/Stranded, or one Flexible conductor (when applicable) is a mandatory information required by IEC, UL and CSA standards (Copper conductors). All other data are provided as supplementary information only. For more details, please consult our CB, UL or CSA certificates and technical datasheet available on <http://www.TE.com>

CE	RoHS	USR	CSA	EAC
----	------	-----	-----	-----

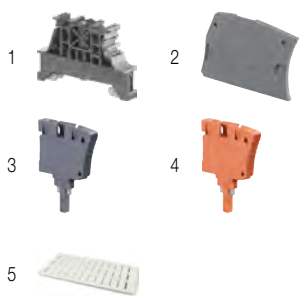

## Accessories

Description	Color	Type	Part Number	Pkg qty	Weight (1 pce) g
1 End stops 10 mm 0.394 in	Dark grey <input checked="" type="checkbox"/>	BAM4	1SNK900001R0000	50	14.00
2 End sections 2.2 mm 0.087 in	Dark grey <input checked="" type="checkbox"/>	ES4	1SNK505910R0000	20	2.20
3 Component plugs Components in series with circuit	Dark grey <input checked="" type="checkbox"/>	PG5	1SNK900401R0000	20	3.50
4 Disconnect plugs Equipped with linking bar	Orange <input checked="" type="checkbox"/>	PG5-R1	1SNK900402R0000	20	3.50
5 Terminal block markers	White <input type="checkbox"/>	MG-CPM 13 41791	1SNB041791R0612	1680	0.27
		MC812	1SNK160000R0000	22	10.00
		MC812PA	1SNK169999R0000	20	14.00
Universal wire markers holder	Grey <input type="checkbox"/>	UMH	1SNK900611R0000	10	0.20

Complete list of accessories is indicated in the terminal block datasheet including end stops. Some accessories such as jumper bars may modify the terminal block's ratings: Complete information available in the accessories section of the catalog.

Technical data valid for copper conductors only.



## SNK series, terminal blocks

### Fuse protection



## Optimize your control circuit protection

Our SNK series fuse terminal blocks offer a full set of features and functions to protect your control circuits with efficiency and reliability.

All terminal blocks complies with the latest evolution of the international standards IEC 60947-7-3 ("Ancillary equipment safety requirements for fuse terminal blocks.") which fixes precise temperature constraint for short-circuit and overload protection (information in the catalogue pages related to the products).

### Qualified for worldwide markets and applications

Eco-designed according to international environmental standards in sustainable development.



## Select the right fuse holder for the right application

### 1 standard applications

The standard fuse holders feature compact dimensions while offering compatibility with 5 x 20 and 5 x 25 mm fuses. double deck terminal blocks allow efficient space reduction for panels with space constraints.

### 2 Expert for convenient circuit distribution

The expert fuse holders are equipped with two central jumper channels for convenient common distribution and are aligned with feed-through and disconnect terminal blocks. They facilitate alternated potential distribution and reduce wiring.

### Additional features for easy trouble shooting and testing

#### Performant blown fuse indicators

Low leakage current (< 0.5 mA) allows the protection of low current circuits such as PLC's inputs without any risk of circuit disturbances.

Large voltage range (24/110 V and 110/250 V AC/DC) reduces the number of variants and allows adaptation to worldwide applications (24/110 V range covers North american market needs).

#### Easy testing

Some terminal blocks are equipped with Dia 2 mm built-in test socket screws for circuit testing while respecting the IP20 touch proof protection.



1  
5x20 and 5x25 mm fuses  
Compact and high density



2  
5x20 and 6.3x32 mm fuses  
Easy potential distribution

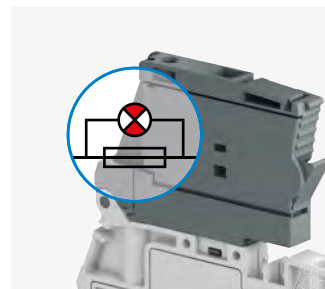

Low leakage current blown fuse indicator.  
Large voltage range: (24/110 V and 110/250 V AC and DC)

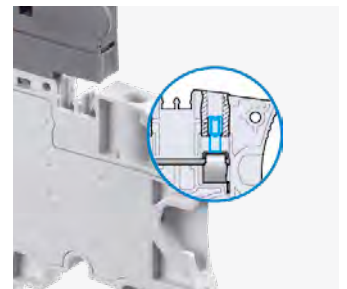

Convenient testing through built in test socket screws



## SNK series, terminal blocks

### Marshalling cabinets application

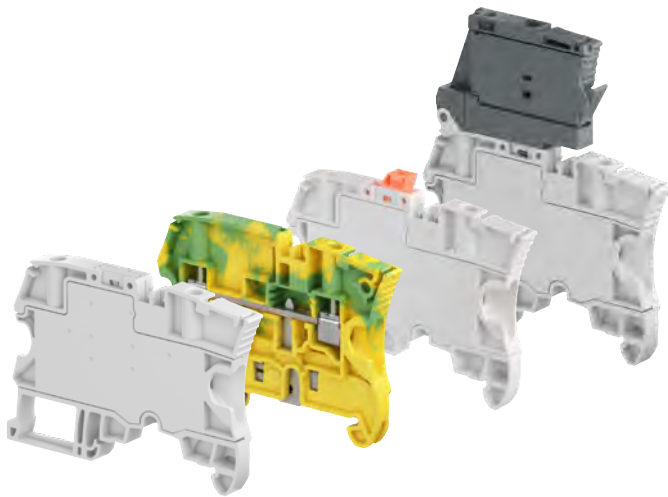

## The smart choice for process automation

Large process automation applications typically require the use of a large number of digital or analog signals and sensors. Indeed, marshalling cabinets ensure an important cross wiring function, since the incoming field signal and the channel quantity of the I/O card of the controller (DCS, large PLC's) is always different. They facilitate the maintenance operations and ease the system modifications.

### SNK aligned terminal blocks offering:

SNK series now features a full set of aligned terminal blocks matching the marshalling panels typical configurations. Fuse, disconnect, feed-through and ground terminal blocks with identical profile are providing compact and convenient solution. With only 6 mm spacing, two aligned screwless jumper channels, central large marking as well as aligned conductor entries, they are perfectly adapted to alternative potential distribution while still easy to connect.

## Typical marshalling configurations

### Digital signals

Popular potential distribution via double center channel.

Disconnect functions equipped with test points allow total isolation of circuits, ease circuit testing during start-up, test and maintenance operations.

### Analog

Potential distribution for analog signals. Ground terminal blocks allow reliable connection of cable shields to the ground sparing the use of external shield bar.

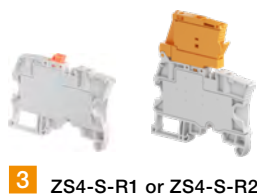
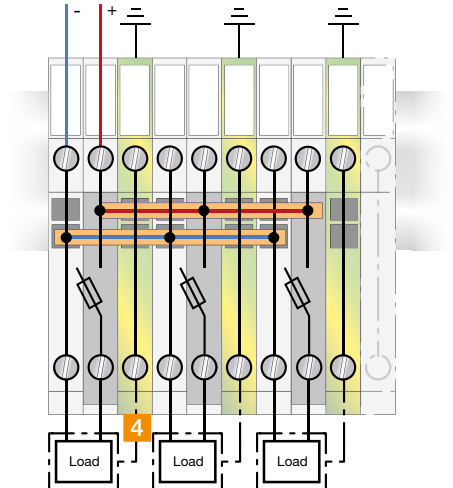
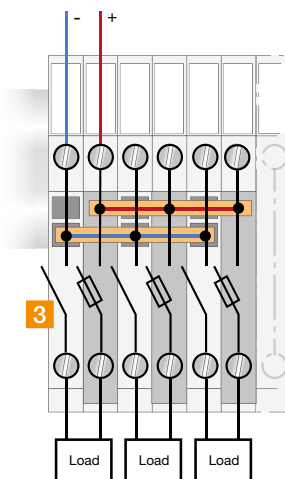
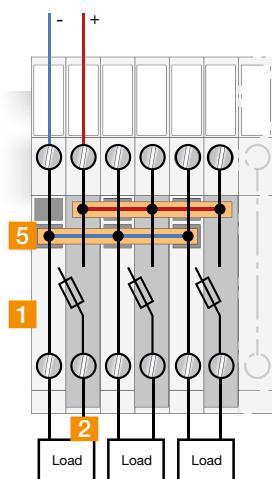

# ZS4-SF1 screw clamp terminal blocks

For 5 x 20 and 5 x 25 fuses - 8 mm 0.315 in spacing

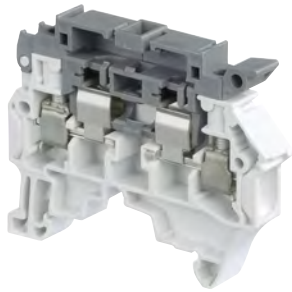

ZS4-SF1

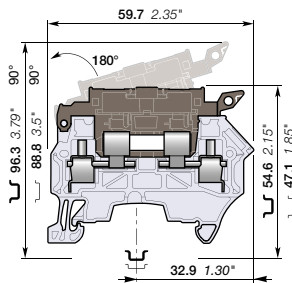

8 mm 0.315 in spacing

## Description

Protect your circuit with 5x25 and 5x20 fuse terminal blocks, compliant with IEC 60947-7-3 standard (fuse not supplied with the terminal blocks).

## Ordering details

Description	Color	Type	Part Number	Pkg qty	Weight (1 pce) g
Fuse	Grey, dark grey	ZS4-SF1	1SNK508410R0000	50	13.30
	Orange, dark grey	ZS4-SF1-OR	1SNK508430R0000	50	13.30

## Main technical data

Connecting capacity		IEC	UL - CSA	Mounting instructions	
1 conductor per clamp	Rigid: Solid/Stranded	0.2 ... 4 mm²	24 ... 10 AWG	Rail	TH 35-7.5, TH 35-15
	Flexible without ferrule	0.22 ... 4 mm²		Wire stripping length	11 mm 0.432 in
	Flexible with non insulated ferrule	0.22 ... 4 mm²	24 ... 12 AWG		
	Flexible with insulated ferrule	0.22 ... 4 mm²	24 ... 12 AWG		
	Gauge	A3-B3			
2 conductors per clamp	Rigid: Solid/Stranded	0.2 ... 2.5 mm²	24 ... 14 AWG	Tool	Flat screwdriver Ø 3.5 mm Ø 0.138 in
	Flexible without ferrule	0.2 ... 2.5 mm²			
	Flexible with twin ferrule	0.22 ... 2.5 mm²	24 ... 14 AWG		
Rated current / Rated cross section		6.3 A / 4 mm²	10 A / 10 AWG	Torque	0.6 Nm ± 0.1 5.31 lb.in ± 0.885
Rated voltage		630 V	300 V		
Impulse withstand voltage		8000 V			
Protection		IP20	NEMA 1		

Separate arrangement		Assembly composed of 1 fuse terminal block in between non fuse terminal blocks	Overload and short-circuit protection	2.5 W
			Exclusive short-circuit protection	4 W
Compound arrangement		Assembly composed of 5 fuse terminal blocks	Overload and short-circuit protection	1.6 W
			Exclusive short-circuit protection	4 W

The connecting capacity data for one Rigid: Solid/Stranded, or one Flexible conductor (when applicable) is a mandatory information required by IEC, UL and CSA standards (Copper conductors). All other data are provided as supplementary information only. For more details, please consult our CB, UL or CSA certificates and technical datasheet available on <http://www.TE.com>

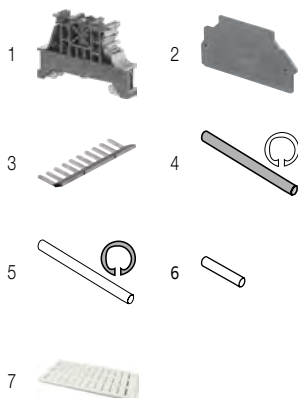
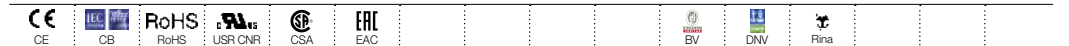

## Accessories

Description	Color	Type	Part Number	Pkg qty	Weight (1 pce) g
1 End stops	Dark grey	BAM4	1SNK900001R0000	50	14.00
2 End sections	Dark grey	ES4-SF	1SNK508960R0000	20	1.80
3 Lateral jumper bars	Grey	PC81-10	1SNA173523R1100	10	5.00
4 Assembly rods		TGA8	1SNA168672R1100	10	1.00
		TGA8	1SNA168673R1200	10	1.50
		TGA8	1SNA168674R1300	10	2.00
5 Spring retaining Rings		ANT	1SNA168675R1400	10	
6 Neutral cartridge		CN5	1SNA179371R1600	10	3.9
7 Terminal block markers	White	MG-CPM 13 41791	1SNB041791R0612	1680	0.27
		MC812	1SNK160000R0000	22	10.00
		MC812PA	1SNK169999R0000	20	14.00
	Grey	UMH	1SNK900611R0000	10	0.20

Complete list of accessories is indicated in the terminal block datasheet including end stops. Some accessories such as jumper bars may modify the terminal block's ratings: Complete information available in the accessories section of the catalog.

Technical data valid for copper conductors only.

# ZS4-SF1-T screw clamp terminal blocks

For 5 x 20 and 5 x 25 fuses - with test socket - 8 mm 0.315 in spacing

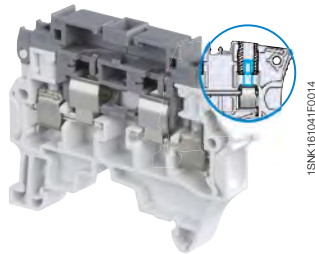
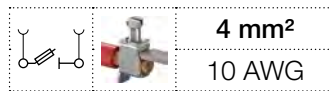

ZS4-SF1-T

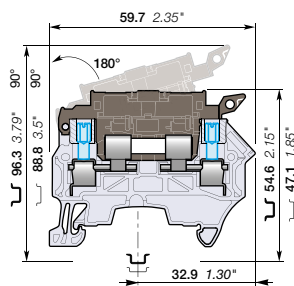

8 mm 0.315 in spacing

## Description

- Protect your circuit with 5x25 and 5x20 fuse terminal blocks (fuse not supplied with the terminal blocks),
- Compliant with IEC 60947-7-3 standard,
- With built in test sockets.

## Ordering details

Description	Color	Type	Part Number	Pkg qty	Weight (1 pce) g
Fuse With 2 test sockets DIA 2 mm 0.079 in	Grey, dark grey	ZS4-SF1-T2	1SNK508411R0000	50	13.30

## Main technical data

Connecting capacity		IEC	UL - CSA	Rail		TH 35-7.5, TH 35-15
1 conductor per clamp	Rigid: Solid/Stranded	0.2 ... 4 mm <sup>2</sup>	24 ... 10 AWG	Wire stripping length		11 mm 0.432 in
	Flexible without ferrule	0.22 ... 4 mm <sup>2</sup>	24 ... 12 AWG			
	Flexible with non insulated ferrule	0.22 ... 4 mm <sup>2</sup>	24 ... 12 AWG			
	Flexible with insulated ferrule	0.22 ... 4 mm <sup>2</sup>	24 ... 12 AWG			
Gauge		A3-B3				
2 conductors per clamp	Rigid: Solid/Stranded	0.2 ... 2.5 mm <sup>2</sup>	24 ... 14 AWG	Tool		Flat screwdriver Ø 3.5 mm Ø 0.138 in
	Flexible without ferrule	0.2 ... 2.5 mm <sup>2</sup>	24 ... 14 AWG			
	Flexible with twin ferrule	0.22 ... 2.5 mm <sup>2</sup>	24 ... 14 AWG			
Rated current / Rated cross section		6.3 A / 4 mm <sup>2</sup>	10 A / 10 AWG			
Rated voltage		630 V	300 V			
Impulse withstand voltage		8000 V				
Protection		IP20	NEMA 1			
				Torque		0.6 Nm ± 0.1 5.31 lb.in ± 0.885

Separate arrangement		Assembly composed of 1 fuse terminal block in between non fuse terminal blocks	Overload and short-circuit protection	2.5 W
			Exclusive short-circuit protection	4 W
Compound arrangement		Assembly composed of 5 fuse terminal blocks	Overload and short-circuit protection	1.6 W
			Exclusive short-circuit protection	4 W

The connecting capacity data for one Rigid: Solid/Stranded, or one Flexible conductor (when applicable) is a mandatory information required by IEC, UL and CSA standards (Copper conductors). All other data are provided as supplementary information only. For more details, please consult our CB, UL or CSA certificates and technical datasheet available on <http://www.TE.com>

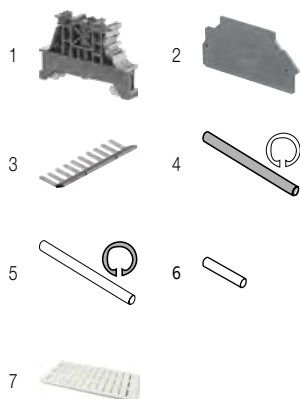
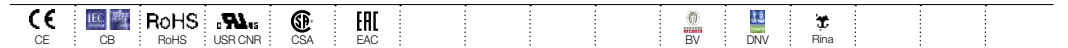

## Accessories

Description	Color	Type	Part Number	Pkg qty	Weight (1 pce) g	
1 End stops 10 mm 0.394 in	Dark grey	BAM4	1SNK900001R0000	50	14.00	
2 End sections 1.5 mm 0.059 in	Dark grey	ES4-SF	1SNK508960R0000	20	1.80	
3 Lateral jumper bars 10 poles 35 A (IEC)	Grey	PC81-10	1SNA173523R1100	10	5.00	
4 Assembly rods 2 poles		TGA8	1SNA168672R1100	10	1.00	
		TGA8	1SNA168673R1200	10	1.50	
		TGA8	1SNA168674R1300	10	2.00	
5 Spring retaining Rings		ANT	1SNA168675R1400	10		
6 Neutral cartridge 5x25		CN5	1SNA179371R1600	10	3.9	
7 Terminal block markers		MG-CPM 13 41791	1SNB041791R0612	1680	0.27	
		MC812	1SNK160000R0000	22	10.00	
		MC812PA	1SNK169999R0000	20	14.00	
	Universal wire markers holder	Grey	UMH	1SNK900611R0000	10	0.20

Complete list of accessories is indicated in the terminal block datasheet including end stops.

Some accessories such as jumper bars may modify the terminal block's ratings. Complete information available in the accessories section of the catalog.

Technical data valid for copper conductors only.

# ZS4-SF1-R screw clamp terminal blocks

For 5 x 20 and 5 x 25 fuses - with blown fuse indicator - 8 mm 0.315 in spacing

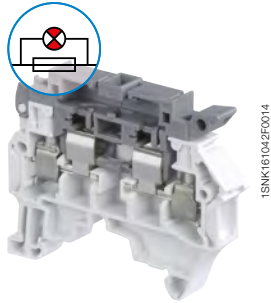
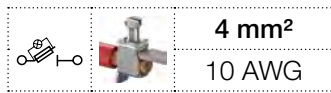

ZS4-SF1-R

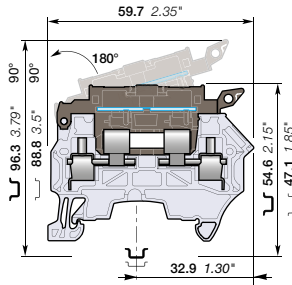

8 mm 0.315 in spacing

## Description

- Protect your circuit with 5x25 and 5x20 fuse terminal blocks (fuse not supplied with the terminal blocks),
- Compliant with IEC 60947-7-3 standard,
- Quickly identify the defective circuit thanks to the blown fuse indicator (with leakage current < 0.5 mA).

## Ordering details

Description	Color	Type	Part Number	Pkg qty	Weight (1 pce) g
Fuse With blown fuse indicator 115 ... 250 V AC / DC	Grey, dark grey	ZS4-SF1-R3	1SNK508414R0000	50	13.30
With blown fuse indicator 24 ... 110 V AC / DC		ZS4-SF1-R1	1SNK508412R0000	50	13.30

## Main technical data

Connecting capacity	IEC	UL - CSA	Mounting instructions		
<b>1 conductor per clamp</b>	Rigid: Solid/Stranded Flexible without ferrule Flexible with non insulated ferrule Flexible with insulated ferrule Gauge	0.2 ... 4 mm <sup>2</sup> 0.22 ... 4 mm <sup>2</sup> 0.22 ... 4 mm <sup>2</sup> 0.22 ... 4 mm <sup>2</sup> A3-B3	24 ... 10 AWG 24 ... 12 AWG 24 ... 12 AWG	Rail Wire stripping length	TH 35-7.5, TH 35-15 11 mm 0.432 in
<b>2 conductors per clamp</b>	Rigid: Solid/Stranded Flexible without ferrule Flexible with twin ferrule	0.2 ... 2.5 mm <sup>2</sup> 0.2 ... 2.5 mm <sup>2</sup> 0.22 ... 2.5 mm <sup>2</sup>	24 ... 14 AWG 24 ... 14 AWG 24 ... 14 AWG	Tool	Flat screwdriver Ø 3.5 mm Ø 0.138 in
<b>Rated current / Rated cross section</b>		6.3 A / 4 mm <sup>2</sup>	10 A / 10 AWG	Torque	0.6 Nm ± 0.1 5.31 lb.in ± 0.885
<b>Rated voltage</b>		630 V	300 V		
<b>Impulse withstand voltage</b>		8000 V			
<b>Protection</b>		IP20	NEMA 1		

Separate arrangement		Assembly composed of 1 fuse terminal block in between non fuse terminal blocks	Overload and short-circuit protection	2.5 W
			Exclusive short-circuit protection	4 W
Compound arrangement		Assembly composed of 5 fuse terminal blocks	Overload and short-circuit protection	1.6 W
			Exclusive short-circuit protection	4 W

The connecting capacity data for one Rigid: Solid/Stranded, or one Flexible conductor (when applicable) is a mandatory information required by IEC, UL and CSA standards (Copper conductors). All other data are provided as supplementary information only. For more details, please consult our CB, UL or CSA certificates and technical datasheet available on <http://www.TE.com>



## Accessories

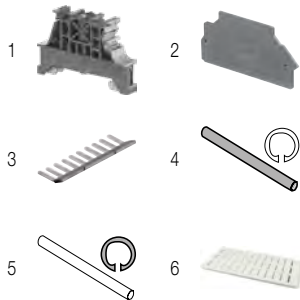

Description	Color	Type	Part Number	Pkg qty	Weight (1 pce) g
1 End stops	Dark grey	BAM4	1SNK900001R0000	50	14.00
2 End sections	Dark grey	ES4-SF	1SNK508960R0000	20	1.80
3 Lateral jumper bars	Grey	PC81-10	1SNA173523R1100	10	5.00
4 Assembly rods		TGA8	1SNA168672R1100	10	1.00
		TGA8	1SNA168673R1200	10	1.50
		TGA8	1SNA168674R1300	10	2.00
5 Spring retaining Rings		ANT	1SNA168675R1400	10	
6 Terminal block markers	White	MG-CPM 13 41791	1SNB041791R0612	1680	0.27
		MC812	1SNK160000R0000	22	10.00
		MC812PA	1SNK169999R0000	20	14.00
	Universal wire markers holder	Grey	UMH	1SNK900611R0000	10

Complete list of accessories is indicated in the terminal block datasheet including end stops.

Some accessories such as jumper bars may modify the terminal block's ratings: Complete information available in the accessories section of the catalog.

Technical data valid for copper conductors only.

# ZS4-SF1-R screw clamp terminal blocks

For 5 x 20 and 5 x 25 fuses - with blown fuse indicator and test sockets - 8 mm 0.315 in spacing

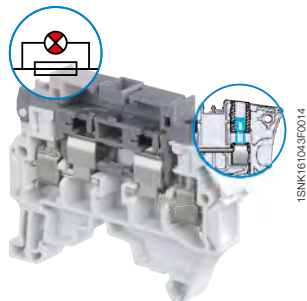

ZS4-SF1-R

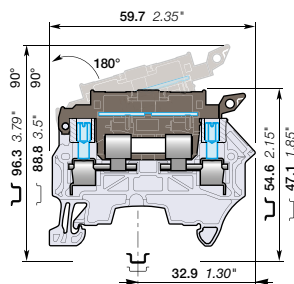

8 mm 0.315 in spacing

## Description

- Protect your circuit with 5x25 and 5x20 fuse terminal blocks (fuse not supplied with the terminal blocks),
- Compliant with IEC 60947-7-3 standard,
- Ease the test with built-in test sockets,
- Quickly identify the defective circuit thanks to the blown fuse indicator (with leakage current < 0.5 mA).

## Ordering details

Description	Color	Type	Part Number	Pkg qty	Weight (1 pce) g
Fuse With blown fuse indicator 115 ... 250 V AC / DC and 2 test sockets DIA 2 mm 0.079 in	Grey, dark grey	ZS4-SF1-R4	1SNK508415R0000	50	13.30
With blown fuse indicator 24 ... 110 V AC / DC and 2 test sockets DIA 2 mm 0.079 in		ZS4-SF1-R2	1SNK508413R0000	50	13.30

## Main technical data

Connecting capacity	IEC	UL - CSA	Mounting instructions		
<b>1 conductor per clamp</b>	Rigid: Solid/Stranded	0.2 ... 4 mm <sup>2</sup>	24 ... 10 AWG	Rail	TH 35-7.5, TH 35-15
	Flexible without ferrule	0.22 ... 4 mm <sup>2</sup>		Wire stripping length	11 mm 0.432 in
	Flexible with non insulated ferrule	0.22 ... 4 mm <sup>2</sup>	24 ... 12 AWG	Tool	Flat screwdriver Ø 3.5 mm Ø 0.138 in
	Flexible with insulated ferrule	0.22 ... 4 mm <sup>2</sup>	24 ... 12 AWG		
	Gauge	A3-B3		Torque	0.6 Nm ± 0.1 5.31 lb.in ± 0.885
<b>2 conductors per clamp</b>	Rigid: Solid/Stranded	0.2 ... 2.5 mm <sup>2</sup>	24 ... 14 AWG		
	Flexible without ferrule	0.2 ... 2.5 mm <sup>2</sup>			
	Flexible with twin ferrule	0.22 ... 2.5 mm <sup>2</sup>	24 ... 14 AWG		
<b>Rated current / Rated cross section</b>		6.3 A / 4 mm <sup>2</sup>	10 A / 10 AWG		
<b>Rated voltage</b>		630 V	300 V		
<b>Impulse withstand voltage</b>		8000 V			
<b>Protection</b>		IP20	NEMA 1		

Separate arrangement		Assembly composed of 1 fuse terminal block in between non fuse terminal blocks	Overload and short-circuit protection	2.5 W
			Exclusive short-circuit protection	4 W
Compound arrangement		Assembly composed of 5 fuse terminal blocks	Overload and short-circuit protection	1.6 W
			Exclusive short-circuit protection	4 W

The connecting capacity data for one Rigid: Solid/Stranded, or one Flexible conductor (when applicable) is a mandatory information required by IEC, UL and CSA standards (Copper conductors). All other data are provided as supplementary information only. For more details, please consult our CB, UL or CSA certificates and technical datasheet available on <http://www.TE.com>

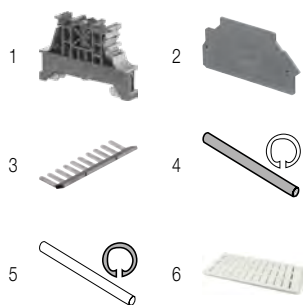
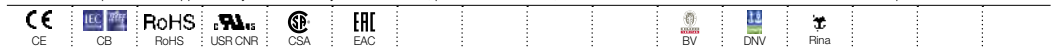

## Accessories

Description	Color	Type	Part Number	Pkg qty	Weight (1 pce) g	
1 <b>End stops</b> 10 mm 0.394 in	Dark grey	BAM4	1SNK900001R0000	50	14.00	
2 <b>End sections</b> 1.5 mm 0.059 in	Dark grey	ES4-SF	1SNK508960R0000	20	1.80	
3 <b>Lateral jumper bars</b> 10 poles 35 A (IEC)	Grey	PC81-10	1SNA173523R1100	10	5.00	
4 <b>Assembly rods</b>		TGA8	1SNA168672R1100	10	1.00	
		TGA8	1SNA168673R1200	10	1.50	
		TGA8	1SNA168674R1300	10	2.00	
5 <b>Spring retaining Rings</b>		ANT	1SNA168675R1400	10		
6 <b>Terminal block markers</b>	Blank marker	White	MG-CPM 13 41791	1SNB041791R0612	1680	0.27
	Blank card		MC812	1SNK160000R0000	22	10.00
			MC812PA	1SNK169999R0000	20	14.00
	Universal wire markers holder	Grey	UMH	1SNK900611R0000	10	0.20

Complete list of accessories is indicated in the terminal block datasheet including end stops. Some accessories such as jumper bars may modify the terminal block's ratings: Complete information available in the accessories section of the catalog.

Technical data valid for copper conductors only.



# ZS4-R1 screw clamp terminal blocks

## Feed-through - 8 mm 0.315 in spacing

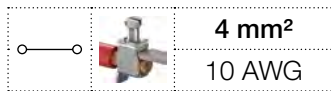

1SNK161048FC014

ZS4-R1

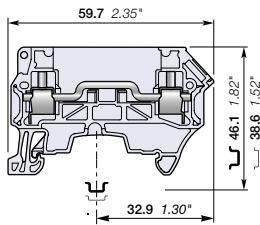

8 mm 0.315 in spacing

### Description

Simplify the alternated feed-through and fuse circuits operations:

- With the same profile as the ZS4-SF1, the wiring of the alternated feed-through and fuse circuits is easier.

### Ordering details

Description	Color	Type	Part Number	Pkg qty	Weight (1 pce) g
Feed-through Profile aligned with ZS4-SF1	Grey <input type="checkbox"/>	ZS4-R1	1SNK508013R0000	50	11.00

### Main technical data

Connecting capacity		IEC	UL - CSA	Mounting instructions		
1 conductor per clamp		Rigid: Solid/Stranded Flexible without ferrule Flexible with non insulated ferrule Flexible with insulated ferrule Gauge	0.2 ... 4 mm <sup>2</sup> 0.22 ... 4 mm <sup>2</sup> 0.22 ... 4 mm <sup>2</sup> 0.22 ... 4 mm <sup>2</sup> A3-B3	24 ... 10 AWG 24 ... 12 AWG 24 ... 12 AWG	Rail Wire stripping length	TH 35-7.5, TH 35-15 11 mm 0.432 in
2 conductors per clamp		Rigid: Solid/Stranded Flexible without ferrule Flexible with twin ferrule	0.2 ... 2.5 mm <sup>2</sup> 0.2 ... 2.5 mm <sup>2</sup> 0.22 ... 2.5 mm <sup>2</sup>	24 ... 14 AWG 24 ... 14 AWG 24 ... 14 AWG	Tool	Flat screwdriver Ø 3.5 mm Ø 0.138 in
Rated current / Rated cross section		24 A / 2.5 mm <sup>2</sup>	26 A / 10 AWG	Torque		0.6 Nm ± 0.1 5.31 lb.in ± 0.885
Rated short-time withstand current (1s)		300 A				
Short Circuit Current Rating (with specific conditions)						
Rated voltage		800 V	300 V			
Impulse withstand voltage		6000 V				
Protection		IP20	NEMA 1			

The connecting capacity data for one Rigid: Solid/Stranded, or one Flexible conductor (when applicable) is a mandatory information required by IEC, UL and CSA standards (Copper conductors). All other data are provided as supplementary information only. For more details, please consult our CB, UL or CSA certificates and technical datasheet available on <http://www.TE.com>



### Accessories

Description	Color	Type	Part Number	Pkg qty	Weight (1 pce) g
1 End stops	Dark grey <input checked="" type="checkbox"/>	BAM4	1SNK900001R0000	50	14.00
2 End sections	Dark grey <input checked="" type="checkbox"/>	ES4-SF	1SNK508960R0000	20	1.80
3 Lateral jumper bars	Grey <input type="checkbox"/>	PC81-10	1SNA173523R1100	10	5.00
4 Terminal block markers	White <input type="checkbox"/>	MG-CPM 13 41791	1SNB041791R0612	1680	0.27
		MC812	1SNK160000R0000	22	10.00
		MC812PA	1SNK169999R0000	20	14.00
Universal wire markers holder	Grey <input type="checkbox"/>	UMH	1SNK900611R0000	10	0.20

Complete list of accessories is indicated in the terminal block datasheet including end stops.

Some accessories such as jumper bars may modify the terminal block's ratings. Complete information available in the accessories section of the catalog.

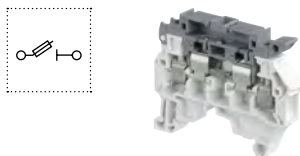
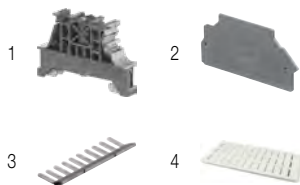

### Fuse screw clamp terminal blocks

Description	Color	Type	Part Number	Pkg qty	Weight (1 pce) g
Fuse	Grey, dark grey <input type="checkbox"/>	ZS4-SF1	1SNK508410R0000	50	13.30

Technical data valid for copper conductors only.

# ZS4-S-R3 screw clamp terminal blocks

## Disconnect with lever - 8 mm 0.315 in spacing

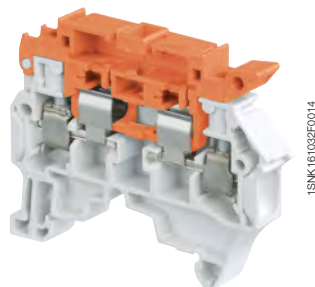

ZS4-S-R3

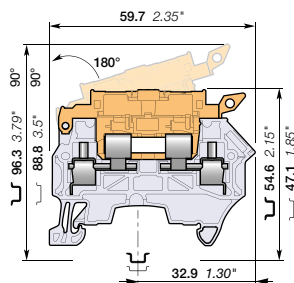

8 mm 0.315 in spacing

### Description

Simplify the disconnect operations for the disconnect terminal blocks installed next to fuse terminal blocks ZS4-SF1:

- With the same profile as ZS4-SF1, the ZS4-S-R3 disconnect lever is easily operated by hand and the wiring of the alternated disconnect and fuse circuits is easier,
- Neutral cartridge CN5 5x25 included.

### Ordering details

Description	Color	Type	Part Number	Pkg qty	Weight (1 pce) g
Disconnect Profile aligned with ZS4-SF1	Grey, orange	ZS4-S-R3	1SNK508416R0000	50	13.30
	Grey, blue	ZS4-S-R3-T2	1SNK508419R0000	50	13.30

### Main technical data

Connecting capacity		IEC	UL - CSA	Mounting instructions	
1 conductor per clamp	Rigid: Solid/Stranded	0.2 ... 4 mm <sup>2</sup>	24 ... 10 AWG	Rail	TH 35-7.5, TH 35-15
	Flexible without ferrule	0.22 ... 4 mm <sup>2</sup>		Wire stripping length	11 mm 0.432 in
	Flexible with non insulated ferrule	0.22 ... 4 mm <sup>2</sup>	24 ... 12 AWG		
	Flexible with insulated ferrule	0.22 ... 4 mm <sup>2</sup>	24 ... 12 AWG		
	Gauge	A3-B3			
2 conductors per clamp	Rigid: Solid/Stranded	0.2 ... 2.5 mm <sup>2</sup>	24 ... 14 AWG	Tool	Flat screwdriver Ø 3.5 mm Ø 0.138 in
	Flexible without ferrule	0.2 ... 2.5 mm <sup>2</sup>			
	Flexible with twin ferrule	0.22 ... 2.5 mm <sup>2</sup>	24 ... 14 AWG		
Rated current / Rated cross section		18 A / 2.5 mm <sup>2</sup>	18 A / 10 AWG	Torque	0.6 Nm ± 0.1 5.31 lb.in ± 0.885
Maximum current / Maximum cross section		18 A / 4 mm <sup>2</sup>			
Rated short-time withstand current (1s)		300 A			
Rated voltage		630 V	300 V		
Impulse withstand voltage		6000 V			
Protection		IP20	NEMA 1		

Recommendation for best usage: in horizontal assemblies, disconnect terminal blocks should be mounted with fixed foot on top (power side) so that the disconnect lever does not partially close through gravity. Furthermore, as specified per IEC 60947-7-1, disconnect terminal blocks are intended to be used for temporary disconnection at zero potential and at no load.

The connecting capacity data for one Rigid: Solid/Stranded, or one Flexible conductor (when applicable) is a mandatory information required by IEC, UL and CSA standards (Copper conductors). All other data are provided as supplementary information only. For more details, please consult our CB, UL or CSA certificates and technical datasheet available on <http://www.TE.com>

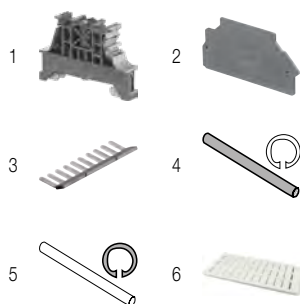
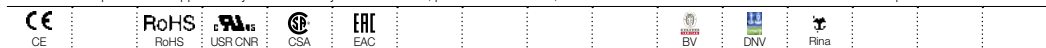

### Accessories

Description	Color	Type	Part Number	Pkg qty	Weight (1 pce) g	
1 End stops 10 mm 0.394 in	Dark grey	BAM4	1SNK900001R0000	50	14.00	
2 End sections 1.5 mm 0.059 in	Dark grey	ES4-SF	1SNK508960R0000	20	1.80	
3 Lateral jumper bars 10 poles 35 A (IEC)	Grey	PC81-10	1SNA173523R1100	10	5.00	
4 Assembly rods		2 poles	TGA8	1SNA168672R1100	10	1.00
		3 poles	TGA8	1SNA168673R1200	10	1.50
		4 poles	TGA8	1SNA168674R1300	10	2.00
5 Spring retaining Rings		ANT	1SNA168675R1400	10		
6 Terminal block markers	White	Blank marker	MG-OPM 13 41791	1SNB041791R0612	1680	0.27
		Blank card	MC812	1SNK160000R0000	22	10.00
			MC812PA	1SNK169999R0000	20	14.00
		Universal wire markers holder	UMH	1SNK900611R0000	10	0.20

Complete list of accessories is indicated in the terminal block datasheet including end stops. Some accessories such as jumper bars may modify the terminal block's ratings: Complete information available in the accessories section of the catalog.

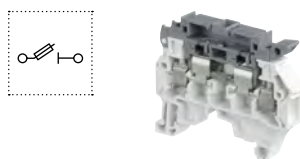

### Fuse screw clamp terminal blocks

Description	Color	Type	Part Number	Pkg qty	Weight (1 pce) g
Fuse	Grey, dark grey	ZS4-SF1	1SNK508410R0000	50	13.30

Technical data valid for copper conductors only.

# ZS4-SF screw clamp terminal blocks

For 5 x 20 fuses - 6 mm 0.236 in spacing

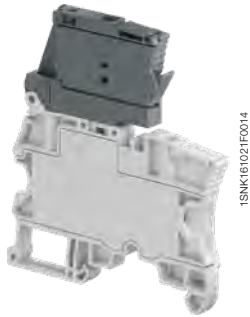

ZS4-SF

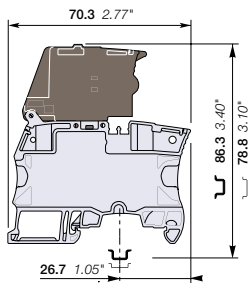

6 mm 0.236 in spacing

## Description

- Protect your circuits with 5x20 fuse terminal blocks compliant with IEC 60947-7-3 standard (fuse not supplied with the terminal blocks),
- Simplify the distribution thanks to the two jumper channels aligned with ZS4 or ZS4-R2 feed-through and ZS4-S-R1 disconnect terminal blocks.

## Ordering details

Description	Color	Type	Part Number	Pkg qty	Weight (1 pce) g
Fuse	Grey, dark grey	ZS4-SF	1SNK506410R0000	50	18.60

## Main technical data

Connecting capacity		IEC	UL - CSA	Mounting instructions	
1 conductor per clamp	Rigid: Solid/Stranded	0.2 ... 4 mm <sup>2</sup>	24 ... 10 AWG	Rail	TH 35-7.5, TH 35-15
	Flexible without ferrule	0.22 ... 4 mm <sup>2</sup>		Wire stripping length	10.5 mm 0.412 in
	Flexible with non insulated ferrule	0.22 ... 4 mm <sup>2</sup>	24 ... 12 AWG	Tool	Flat screwdriver Ø 3.5 mm Ø 0.138 in
	Flexible with insulated ferrule	0.22 ... 4 mm <sup>2</sup>	24 ... 12 AWG		
Gauge		A3-B3		Torque	0.6 Nm ± 0.1 5.31 lb.in ± 0.885
2 conductors per clamp	Rigid: Solid/Stranded	0.2 ... 1.5 mm <sup>2</sup>	24 ... 16 AWG	Rated voltage	500 V
	Flexible without ferrule	0.2 ... 1.5 mm <sup>2</sup>			
Flexible with twin ferrule	0.22 ... 1.5 mm <sup>2</sup>	24 ... 16 AWG	Impulse withstand voltage		
Rated current / Rated cross section		6.3 A / 4 mm <sup>2</sup>		10 A / 10 AWG	Protection
				NEMA 1	

Mount your fuse safely without touching any active part: put the fuse into the hooks of the fuse holder shutter; at the closing of the shutter, the fuse is perfectly in place in the fuse holder.

Separate arrangement		Assembly composed of 1 fuse terminal block in between non fuse terminal blocks	Overload and short-circuit protection	2.5 W
			Exclusive short-circuit protection	4 W
Compound arrangement		Assembly composed of 5 fuse terminal blocks	Overload and short-circuit protection	2.5 W
			Exclusive short-circuit protection	4 W

The connecting capacity data for one Rigid: Solid/Stranded, or one Flexible conductor (when applicable) is a mandatory information required by IEC, UL and CSA standards (Copper conductors). All other data are provided as supplementary information only. For more details, please consult our CB, UL or CSA certificates and technical datasheet available on <http://www.TE.com>

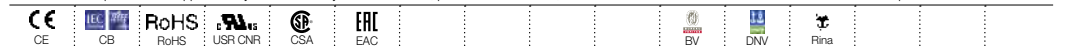

## Accessories

Description	Color	Type	Part Number	Pkg qty	Weight (1 pce) g
1 End stops	Dark grey	BAM4	1SNK900001R0000	50	14.00
2 Jumper bars	Orange	JB6-2	1SNK906302R0000	50	1.30
		JB6-3	1SNK906303R0000	50	2.10
		JB6-4	1SNK906304R0000	50	2.90
		JB6-5	1SNK906305R0000	50	3.60
		JB6-10	1SNK906310R0000	20	7.40
3 Test adapters	Dark grey	TP2	1SNK900203R0000	20	1.70
		TP4	1SNK900205R0000	20	2.40
4 Test connectors	Dark grey	TC5-R1	1SNK900201R0000	10	5.20
5 Spacers	Dark grey	ES-TC6	1SNK900105R0000	10	0.80
6 Terminal block markers	White	MG-CPM 13 41791	1SNB041791R0612	1680	0.27
		MC612	1SNK150000R0000	22	10.00
		MC612PA	1SNK159999R0000	20	11.00
	Universal wire markers holder	Grey	UMH	1SNK900611R0000	10

Complete list of accessories is indicated in the terminal block datasheet including end stops. Some accessories such as jumper bars may modify the terminal block's ratings: Complete information available in the accessories section of the catalog.

Technical data valid for copper conductors only.

# ZS4-SF-T screw clamp terminal blocks

For 5 x 20 fuses - with test socket - 6 mm 0.236 in spacing

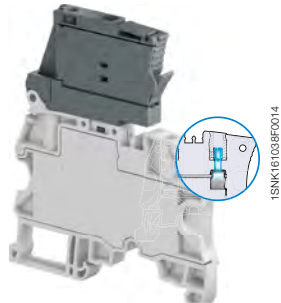
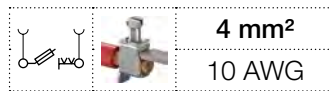

ZS4-SF-T

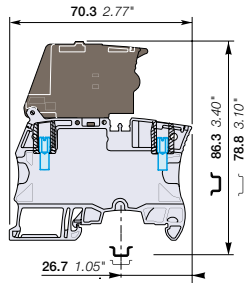

6 mm 0.236 in spacing

## Description

- Protect your circuits with 5x20 fuse terminal blocks compliant with IEC 60947-7-3 standard (fuse not supplied with the terminal blocks),
- Simplify the distribution thanks to the two jumper channels aligned with ZS4 or ZS4-R2 feed-through and ZS4-S-R1 disconnect terminal blocks,
- Ease the test with built-in test socket screws.

## Ordering details

Description	Color	Type	Part Number	Pkg qty	Weight (1 pce) g
Fuse With 2 test sockets DIA 2 mm 0.079 in	Grey, dark grey	ZS4-SF-T2	1SNK506411R0000	50	18.60

## Main technical data

Connecting capacity		IEC	UL - CSA	Mounting instructions	
1 conductor per clamp	Rigid: Solid/Stranded	0.2 ... 4 mm <sup>2</sup>	24 ... 10 AWG	Rail	TH 35-7.5, TH 35-15
	Flexible without ferrule	0.22 ... 4 mm <sup>2</sup>		Wire stripping length	10.5 mm 0.412 in
	Flexible with non insulated ferrule	0.22 ... 4 mm <sup>2</sup>	24 ... 12 AWG	Tool	Flat screwdriver Ø 3.5 mm Ø 0.138 in
	Flexible with insulated ferrule	0.22 ... 4 mm <sup>2</sup>	24 ... 12 AWG		
2 conductors per clamp	Gauge	A3-B3		Torque	0.6 Nm ± 0.1 5.31 lb.in ± 0.885
	Rigid: Solid/Stranded	0.2 ... 1.5 mm <sup>2</sup>	24 ... 16 AWG		
	Flexible without ferrule	0.2 ... 1.5 mm <sup>2</sup>	24 ... 16 AWG		
Rated current / Rated cross section		6.3 A / 4 mm <sup>2</sup>	10 A / 10 AWG		
Rated voltage		500 V	150 V		
Impulse withstand voltage		6000 V			
Protection		IP20	NEMA 1		

Mount your fuse safely without touching any active part: put the fuse into the hooks of the fuse holder shutter; at the closing of the shutter, the fuse is perfectly in place in the fuse holder.

Separate arrangement		Assembly composed of 1 fuse terminal block in between non fuse terminal blocks	Overload and short-circuit protection	2.5 W
			Exclusive short-circuit protection	4 W
Compound arrangement		Assembly composed of 5 fuse terminal blocks	Overload and short-circuit protection	2.5 W
			Exclusive short-circuit protection	4 W

The connecting capacity data for one Rigid: Solid/Stranded, or one Flexible conductor (when applicable) is a mandatory information required by IEC, UL and CSA standards (Copper conductors). All other data are provided as supplementary information only. For more details, please consult our CB, UL or CSA certificates and technical datasheet available on <http://www.TE.com>

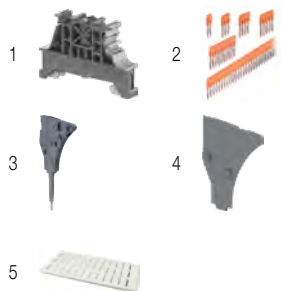
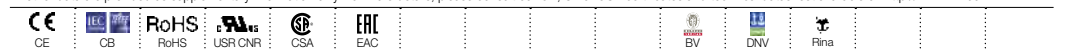

## Accessories

Description	Color	Type	Part Number	Pkg qty	Weight (1 pce) g	
1 End stops	Dark grey	BAM4	1SNK900001R0000	50	14.00	
2 Jumper bars	Orange	2 poles 41 A (IEC)	JB6-2	1SNK906302R0000	50	1.30
		3 poles 41 A (IEC)	JB6-3	1SNK906303R0000	50	2.10
		4 poles 41 A (IEC)	JB6-4	1SNK906304R0000	50	2.90
		5 poles 41 A (IEC)	JB6-5	1SNK906305R0000	50	3.60
		10 poles 41 A (IEC)	JB6-10	1SNK906310R0000	20	7.40
3 Test connectors	Dark grey	TC5-R1	1SNK900201R0000	10	5.20	
4 Spacers	Dark grey	ES-TC6	1SNK900105R0000	10	0.80	
5 Terminal block markers	White	Blank marker	MG-CPM 13 41791	1SNB041791R0612	1680	0.27
		Blank card	MC612	1SNK150000R0000	22	10.00
			MC612PA	1SNK159999R0000	20	11.00
Universal wire markers holder	Grey	UMH	1SNK900611R0000	10	0.20	

Complete list of accessories is indicated in the terminal block datasheet including end stops.

Some accessories such as jumper bars may modify the terminal block's ratings: Complete information available in the accessories section of the catalog.

Technical data valid for copper conductors only.

# ZS4-SF-R screw clamp terminal blocks

For 5 x 20 fuses - with blown fuse indicator - 6 mm 0.236 in spacing

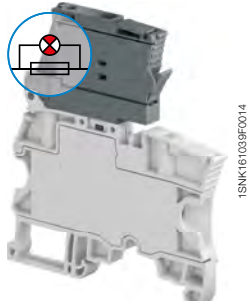

ZS4-SF-R

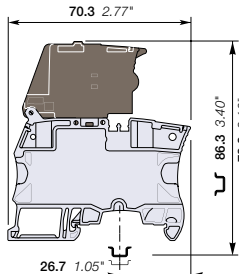

6 mm 0.236 in spacing

## Description

- Protect your circuits with 5x20 fuse terminal blocks compliant with IEC 60947-7-3 standard (fuse not supplied with the terminal blocks),
- Simplify the distribution thanks to the two jumper channels aligned with ZS4 or ZS4-R2 feed-through and ZS4-S-R1 disconnect terminal blocks,
- Quickly identify the defective circuit thanks to the blown fuse indicator (with leakage current < 0.5 mA).

## Ordering details

Description	Color	Type	Part Number	Pkg qty	Weight (1 pce) g
Fuse With blown fuse indicator 115 ... 250 V AC / DC	Grey, dark grey	ZS4-SF-R3	1SNK506415R0000	50	18.60
With blown fuse indicator 24 ... 110 V AC / DC		ZS4-SF-R1	1SNK506412R0000	50	18.60

## Main technical data

Connecting capacity		IEC	UL - CSA	Mounting instructions	
1 conductor per clamp	Rigid: Solid/Stranded	0.2 ... 4 mm <sup>2</sup>	24 ... 10 AWG	Rail	TH 35-7.5, TH 35-15
	Flexible without ferrule	0.22 ... 4 mm <sup>2</sup>		Wire stripping length	10.5 mm 0.412 in
	Flexible with non insulated ferrule	0.22 ... 4 mm <sup>2</sup>	24 ... 12 AWG	Tool	Flat screwdriver Ø 3.5 mm Ø 0.138 in
	Flexible with insulated ferrule	0.22 ... 4 mm <sup>2</sup>	24 ... 12 AWG		
Gauge		A3-B3		Torque	0.6 Nm ± 0.1 5.31 lb.in ± 0.885
2 conductors per clamp	Rigid: Solid/Stranded	0.2 ... 1.5 mm <sup>2</sup>	24 ... 16 AWG		
	Flexible without ferrule	0.2 ... 1.5 mm <sup>2</sup>			
	Flexible with twin ferrule	0.22 ... 1.5 mm <sup>2</sup>	24 ... 16 AWG		
Rated current / Rated cross section		6.3 A / 4 mm <sup>2</sup>	10 A / 10 AWG		
Rated voltage		500 V	150 V		
Impulse withstand voltage		6000 V			
Protection		IP20	NEMA 1		

Mount your fuse safely without touching any active part: put the fuse into the hooks of the fuse holder shutter; at the closing of the shutter, the fuse is perfectly in place in the fuse holder.

Separate arrangement		Assembly composed of 1 fuse terminal block in between non fuse terminal blocks	Overload and short-circuit protection	2.5 W
			Exclusive short-circuit protection	4 W
Compound arrangement		Assembly composed of 5 fuse terminal blocks	Overload and short-circuit protection	2.5 W
			Exclusive short-circuit protection	4 W

The connecting capacity data for one Rigid: Solid/Stranded, or one Flexible conductor (when applicable) is a mandatory information required by IEC, UL and CSA standards (Copper conductors). All other data are provided as supplementary information only. For more details, please consult our CB, UL or CSA certificates and technical datasheet available on <http://www.TE.com>

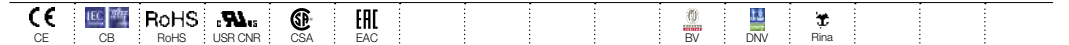

## Accessories

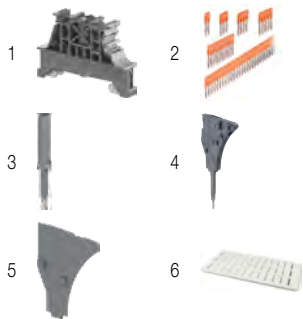

Description	Color	Type	Part Number	Pkg qty	Weight (1 pce) g	
1 End stops	Dark grey	BAM4	1SNK900001R0000	50	14.00	
2 Jumper bars	Orange	2 poles	JB6-2	1SNK906302R0000	50	1.30
		3 poles	JB6-3	1SNK906303R0000	50	2.10
		4 poles	JB6-4	1SNK906304R0000	50	2.90
		5 poles	JB6-5	1SNK906305R0000	50	3.60
		10 poles	JB6-10	1SNK906310R0000	20	7.40
3 Test adapters	Dark grey	For test plugs DIA 2 mm 0.079 in	TP2	1SNK900203R0000	20	1.70
		For test plugs DIA 4 mm 0.157 in	TP4	1SNK900205R0000	20	2.40
4 Test connectors	Dark grey	TC5-R1	1SNK900201R0000	10	5.20	
5 Spacers	Dark grey	ES-TC6	1SNK900105R0000	10	0.80	
6 Terminal block markers	White	Blank marker	MG-CPM 13 41791	1SNB041791R0612	1680	0.27
		Blank card	MC612	1SNK150000R0000	22	10.00
			MC612PA	1SNK159999R0000	20	11.00
	Universal wire markers holder	Grey	UMH	1SNK900611R0000	10	0.20

Complete list of accessories is indicated in the terminal block datasheet including end stops. Some accessories such as jumper bars may modify the terminal block's ratings: Complete information available in the accessories section of the catalog.

Technical data valid for copper conductors only.



# ZS4-SF-R screw clamp terminal blocks

For 5 x 20 fuses - with blown fuse indicator and test sockets - 6 mm 0.236 in spacing

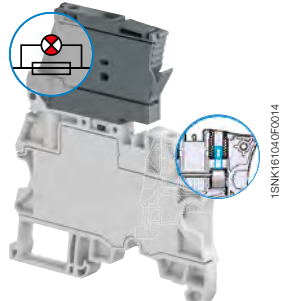

ZS4-SF-R

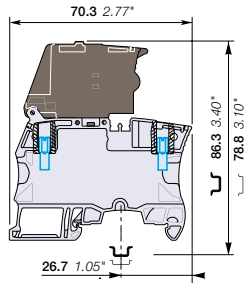

6 mm 0.236 in spacing

## Description

- Protect your circuits with 5x20 fuse terminal blocks compliant with IEC 60947-7-3 standard (fuse not supplied with the terminal blocks),
- Simplify the distribution thanks to the two jumper channels aligned with ZS4 or ZS4-R2 feed-through and ZS4-S-R1 disconnect terminal blocks,
- Ease the test with built-in test socket screws,
- Quickly identify the defective circuit thanks to the blown fuse indicator (with leakage current < 0.5 mA).

## Ordering details

Description	Color	Type	Part Number	Pkg qty	Weight (1 pce) g
Fuse With blown fuse indicator 115 ... 250 V AC / DC and 2 test sockets DIA 2 mm 0.079 in	Grey, dark grey	ZS4-SF-R4	1SNK506416R0000	50	18.60
With blown fuse indicator 24 ... 110 V AC / DC and 2 test sockets DIA 2 mm 0.079 in		ZS4-SF-R2	1SNK506413R0000	50	18.60

## Main technical data

Connecting capacity	IEC	UL - CSA	Mounting instructions	
1 conductor per clamp	Rigid: Solid/Stranded	0.2 ... 4 mm²	24 ... 10 AWG	Rail
	Flexible without ferrule	0.22 ... 4 mm²	24 ... 12 AWG	Wire stripping length
	Flexible with non insulated ferrule	0.22 ... 4 mm²	24 ... 12 AWG	TH 35-7.5, TH 35-15
	Flexible with insulated ferrule	0.22 ... 4 mm²	24 ... 12 AWG	10.5 mm 0.412 in
2 conductors per clamp	Gauge	A3-B3		
	Rigid: Solid/Stranded	0.2 ... 1.5 mm²	24 ... 16 AWG	Tool
	Flexible without ferrule	0.2 ... 1.5 mm²	24 ... 16 AWG	Flat screwdriver Ø 3.5 mm Ø 0.138 in
Rated current / Rated cross section	Flexible with twin ferrule	0.22 ... 1.5 mm²	24 ... 16 AWG	Torque
		6.3 A / 4 mm²	10 A / 10 AWG	0.6 Nm ± 0.1 5.31 lb.in ± 0.885
Rated voltage	500 V	150 V		
Impulse withstand voltage	6000 V			
Protection	IP20	NEMA 1		

Mount your fuse safely without touching any active part: put the fuse into the hooks of the fuse holder shutter; at the closing of the shutter, the fuse is perfectly in place in the fuse holder.

Separate arrangement	Compound arrangement	Protection	Power
Assembly composed of 1 fuse terminal block in between non fuse terminal blocks	Assembly composed of 5 fuse terminal blocks	Overload and short-circuit protection	2.5 W
		Exclusive short-circuit protection	4 W

The connecting capacity data for one Rigid: Solid/Stranded, or one Flexible conductor (when applicable) is a mandatory information required by IEC, UL and CSA standards (Copper conductors). All other data are provided as supplementary information only. For more details, please consult our CB, UL or CSA certificates and technical datasheet available on <http://www.TE.com>

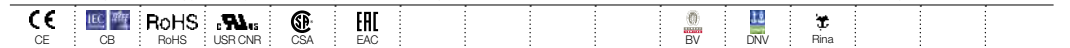

## Accessories

Description	Color	Type	Part Number	Pkg qty	Weight (1 pce) g	
1 End stops	Dark grey	BAM4	1SNK900001R0000	50	14.00	
2 Jumper bars	Orange	2 poles	JB6-2	1SNK906302R0000	50	1.30
		3 poles	JB6-3	1SNK906303R0000	50	2.10
		4 poles	JB6-4	1SNK906304R0000	50	2.90
		5 poles	JB6-5	1SNK906305R0000	50	3.60
		10 poles	JB6-10	1SNK906310R0000	20	7.40
		3 Test connectors	Dark grey	TC5-R1	1SNK900201R0000	10
4 Spacers	Dark grey	ES-TC6	1SNK900105R0000	10	0.80	
5 Terminal block markers	White	Blank marker	MG-CPM 13 41791	1SNB041791R0612	1680	0.27
		Blank card	MC612	1SNK150000R0000	22	10.00
		Universal wire markers holder	MC612PA	1SNK159999R0000	20	11.00
	Grey	UMH	1SNK900611R0000	10	0.20	

Complete list of accessories is indicated in the terminal block datasheet including end stops. Some accessories such as jumper bars may modify the terminal block's ratings: Complete information available in the accessories section of the catalog.

Technical data valid for copper conductors only.

# ZS4-R2 screw clamp terminal blocks

## Feed-through - 6 mm 0.236 in spacing

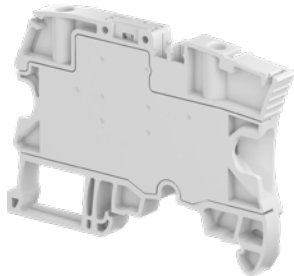

1SNK16107AV0014

ZS4-R2

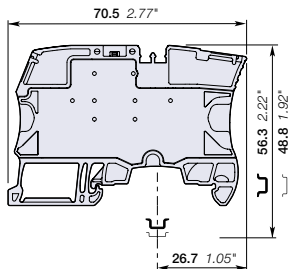

6 mm 0.236 in spacing

### Description

- Simplify the distribution of circuits in marshalling cabinets thanks to our feed-through terminal blocks with the same profile as ZS4-SF fuse, ZS4-S-R1 disconnect and ZS4-PE-R2 ground terminal blocks: aligned conductor entries, jumper channels and marking in just 6 mm 0.236 in spacing,
- No end section needed: closed block.

### Ordering details

Description	Color	Type	Part Number	Pkg qty	Weight (1 pce) <b>g</b>
Feed-through Profile aligned with ZS4-SF and ZS4-S-R1	Grey <input type="checkbox"/>	ZS4-R2	1SNK506013R0000	50	12.40

### Main technical data

Connecting capacity		IEC	UL - CSA	Mounting instructions	
1 conductor per clamp	Rigid: Solid/Stranded	0.2 ... 4 mm <sup>2</sup>	24 ... 10 AWG	Rail	TH 35-7.5, TH 35-15
	Flexible without ferrule	0.22 ... 4 mm <sup>2</sup>		Wire stripping length	10.5 mm 0.413 in
	Flexible with non insulated ferrule	0.22 ... 4 mm <sup>2</sup>	24 ... 12 AWG	Tool	Flat screwdriver Ø 3.5 mm Ø 0.138 in
	Flexible with insulated ferrule	0.22 ... 4 mm <sup>2</sup>	24 ... 12 AWG		
Gauge A3-B3				Torque	0.6 Nm ± 0.1 5.31 lb.in ± 0.885
2 conductors per clamp	Rigid: Solid/Stranded	0.2 ... 1.5 mm <sup>2</sup>	24 ... 16 AWG		
	Flexible without ferrule	0.2 ... 1.5 mm <sup>2</sup>	24 ... 16 AWG		
	Flexible with twin ferrule	0.22 ... 1.5 mm <sup>2</sup>	24 ... 16 AWG		
Rated current / Rated cross section		32 A / 4 mm <sup>2</sup>	30 A / 10 AWG		
Rated short-time withstand current (1s)		480 A			
Rated voltage		800 V	300 V		
Impulse withstand voltage		8000 V			
Protection		IP20	NEMA 1		

The connecting capacity data for one Rigid: Solid/Stranded, or one Flexible conductor (when applicable) is a mandatory information required by IEC, UL and CSA standards (Copper conductors). All other data are provided as supplementary information only. For more details, please consult our CB, UL or CSA certificates and technical datasheet available on <http://www.TE.com>

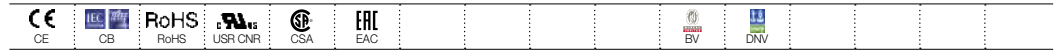

### Accessories

Description	Color	Type	Part Number	Pkg qty	Weight (1 pce) <b>g</b>
1 End stops 10 mm 0.394 in	Dark grey <input type="checkbox"/>	BAM4	1SNK900001R0000	50	14.00
2 Jumper bars 2 poles 41 A (IEC)	Orange <input type="checkbox"/>	JB6-2	1SNK906302R0000	50	1.30
		JB6-3	1SNK906303R0000	50	2.10
		JB6-4	1SNK906304R0000	50	2.90
		JB6-5	1SNK906305R0000	50	3.60
		JB6-10	1SNK906310R0000	20	7.40
3 Cross spacing jumpers 3 poles 32 A (IEC)	Orange <input type="checkbox"/>	JB85-3	1SNK900603R0000	10	2.80
4 Test adapters For test plugs DIA 2 mm 0.079 in	Dark grey <input type="checkbox"/>	TP2	1SNK900203R0000	20	1.70
		TP4	1SNK900205R0000	20	2.40
5 Test connectors End module, 5.2 mm 0.205 in	Dark grey <input type="checkbox"/>	TC5-R1	1SNK900201R0000	10	5.20
6 Spacers 0.8 mm 0.031 in	Dark grey <input type="checkbox"/>	ES-TC6	1SNK900105R0000	10	0.80
7 Terminal block markers Blank marker	White <input type="checkbox"/>	MG-CPM 13 41791	1SNB041791R0612	1680	0.27
		MC612	1SNK150000R0000	22	10.00
		MC612PA	1SNK159999R0000	20	11.00
Universal wire markers holder	Grey <input type="checkbox"/>	UMH	1SNK900611R0000	10	0.20

Complete list of accessories is indicated in the terminal block datasheet including end stops. Some accessories such as jumper bars may modify the terminal block's ratings: Complete information available in the accessories section of the catalog.

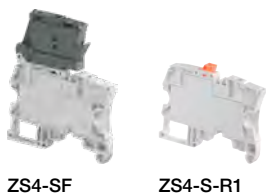
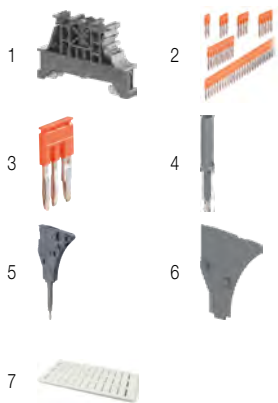

ZS4-SF

ZS4-S-R1

### Screw clamp terminal blocks

Description	Color	Type	Part Number	Pkg qty	Weight (1 pce) <b>g</b>
Fuse Profile aligned with ZS4-R2 and ZS4-PE-R2	Grey, dark grey <input type="checkbox"/>	ZS4-SF	1SNK506410R0000	50	18.60
Disconnect Profile aligned with ZS4-R2 and ZS4-PE-R2	Grey <input type="checkbox"/>	ZS4-S-R1	1SNK506310R0000	50	13.20

Technical data valid for copper conductors only.

# ZS4-PE-R2 screw clamp terminal blocks

Ground - 6 mm 0.236 in spacing



ZS4-PE-R2

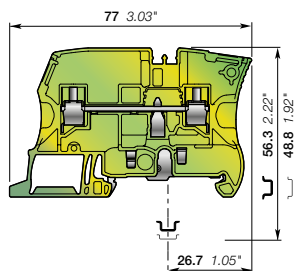

6 mm 0.236 in spacing

## Description

Simplify the shielding connection of your analog circuits in marshalling cabinets thanks to our ground terminal blocks with the same profile as ZS4-SF fuse, ZS4-S-R1 disconnect and ZS4-R2 feed-through terminal blocks.

## Ordering details

Description	Color	Type	Part Number	Pkg qty	Weight (1 pce) g
Ground Screwless rail connection	Green-yellow	ZS4-PE-R2	1SNK506153R0000	25	15.30

## Main technical data

Connecting capacity	IEC	UL - CSA	Mounting instructions
<b>1 conductor per clamp</b>			
Rigid: Solid/Stranded	0.2 ... 4 mm²	24 ... 10 AWG	Rail  TH 35-7.5, TH 35-15
Flexible without ferrule	0.22 ... 4 mm²	24 ... 12 AWG	Wire stripping length  10.5 mm 0.413 in
Flexible with non insulated ferrule	0.22 ... 4 mm²	24 ... 12 AWG	Tool  Flat screwdriver Ø 3.5 mm Ø 0.138 in
Flexible with insulated ferrule	0.22 ... 4 mm²	24 ... 12 AWG	
Gauge	A3-B3		Torque  0.6 Nm ± 0.1 5.31 lb.in ± 0.885
<b>Rated cross section</b>	4 mm²	10 AWG	
<b>Rated short-time withstand current (1s)</b>	480 A	396 A	
<b>Protection</b>	IP20	NEMA 1	

The connecting capacity data for one Rigid: Solid/Stranded, or one Flexible conductor (when applicable) is a mandatory information required by IEC, UL and CSA standards (Copper conductors). All other data are provided as supplementary information only. For more details, please consult our CB, UL or CSA certificates and technical datasheet available on <http://www.TE.com>

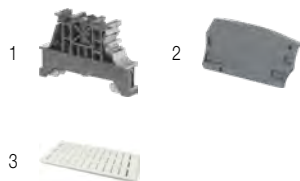
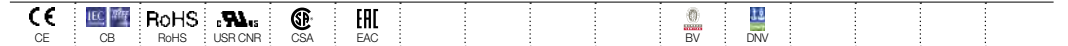

## Accessories

Description	Color	Type	Part Number	Pkg qty	Weight (1 pce) g
<b>1 End stops</b>	Dark grey	BAM4	1SNK900001R0000	50	14.00
<b>2 End sections</b>	Dark grey	ES6-4S	1SNK505911R0000	20	3.10
<b>3 Terminal block markers</b>	White	MG-CPM 13 41791	1SNB041791R0612	1680	0.27
		MC612PA	1SNK150000R0000	22	10.00
		MC612PA	1SNK159999R0000	20	11.00
Universal wire markers holder	Grey	UMH	1SNK900611R0000	10	0.20

Complete list of accessories is indicated in the terminal block datasheet including end stops. Some accessories such as jumper bars may modify the terminal block's ratings: Complete information available in the accessories section of the catalog.



ZS4-SF

ZS4-S-R1

## Screw clamp terminal blocks

Description	Color	Type	Part Number	Pkg qty	Weight (1 pce) g
<b>Fuse</b>	Grey, dark grey	ZS4-SF	1SNK506410R0000	50	18.60
<b>Disconnect</b>	Grey	ZS4-S-R1	1SNK506310R0000	50	13.20

Technical data valid for copper conductors only.

# ZS4-S-R2 screw clamp terminal blocks

## Disconnect with lever - 6 mm 0.236 in spacing

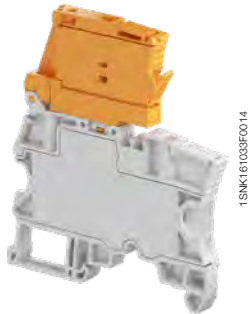
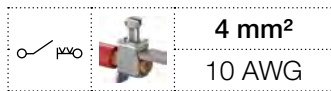

ZS4-S-R2

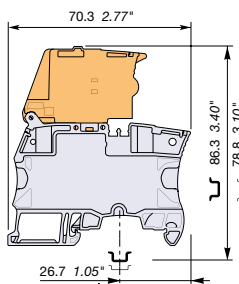

6 mm 0.236 in spacing

### Description

Simplify the disconnect operations for the disconnect terminal blocks installed next to fuse terminal blocks ZS4-SF:  
 – With the same profile as ZS4-SF, the ZS4-S-R2 disconnect lever is easily operated by hand and the wiring of the alternated disconnect and fuse circuits is easier.

### Ordering details

Description	Color	Type	Part Number	Pkg qty	Weight (1 pce) g
Disconnect Profile aligned with ZS4-SF	Grey, orange	ZS4-S-R2	1SNK506414R0000	50	21.6

### Main technical data

Connecting capacity		IEC	UL - CSA	Mounting instructions	
1 conductor per clamp	Rigid: Solid/Stranded	0.2 ... 4 mm <sup>2</sup>	24 ... 10 AWG	Rail	TH 35-7.5, TH 35-15
	Flexible without ferrule	0.22 ... 4 mm <sup>2</sup>		Wire stripping length	10.5 mm 0.412 in
	Flexible with non insulated ferrule	0.22 ... 4 mm <sup>2</sup>	24 ... 12 AWG		Tool
	Flexible with insulated ferrule	0.22 ... 4 mm <sup>2</sup>	24 ... 12 AWG	Torque	
Gauge	A3-B3				
2 conductors per clamp	Rigid: Solid/Stranded	0.2 ... 1.5 mm <sup>2</sup>	24 ... 16 AWG		
	Flexible without ferrule	0.2 ... 1.5 mm <sup>2</sup>			
	Flexible with twin ferrule	0.22 ... 1.5 mm <sup>2</sup>	24 ... 16 AWG		
Rated current / Rated cross section		18 A / 2.5 mm <sup>2</sup>	13 A / 10 AWG		
Maximum current / Maximum cross section		18 A / 4 mm <sup>2</sup>			
Rated short-time withstand current (1s)		300 A			
Rated voltage		400 V	150 V		
Impulse withstand voltage		6000 V			
Protection		IP20	NEMA 1		

Recommendation for best usage: in horizontal assemblies, disconnect terminal blocks should be mounted with fixed foot on top (power side) so that the disconnect lever does not partially close through gravity. Furthermore, as specified per IEC 60947-7-1, disconnect terminal blocks are intended to be used for temporary disconnection at zero potential and at no load.

The connecting capacity data for one Rigid: Solid/Stranded, or one Flexible conductor (when applicable) is a mandatory information required by IEC, UL and CSA standards (Copper conductors). All other data are provided as supplementary information only. For more details, please consult our CB, UL or CSA certificates and technical datasheet available on <http://www.TE.com>

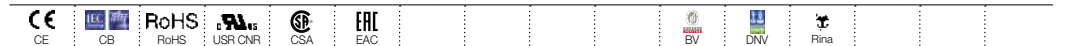

### Accessories

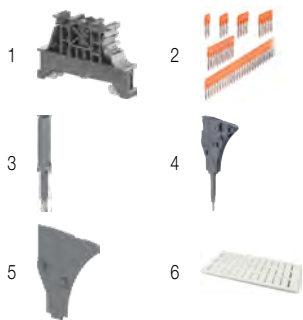

Description	Color	Type	Part Number	Pkg qty	Weight (1 pce) g	
1 End stops	Dark grey	BAM4	1SNK900001R0000	50	14.00	
2 Jumper bars	Orange	2 poles	JB6-2	1SNK906302R0000	50	1.30
		3 poles	JB6-3	1SNK906303R0000	50	2.10
		4 poles	JB6-4	1SNK906304R0000	50	2.90
		5 poles	JB6-5	1SNK906305R0000	50	3.60
		10 poles	JB6-10	1SNK906310R0000	20	7.40
3 Test adapters	Dark grey	For test plugs DIA 2 mm 0.079 in	TP2	1SNK900203R0000	20	1.70
		For test plugs DIA 4 mm 0.157 in	TP4	1SNK900205R0000	20	2.40
4 Test connectors	Dark grey	TC5-R1	1SNK900201R0000	10	5.20	
5 Spacers	Dark grey	ES-TC6	1SNK900105R0000	10	0.80	
6 Terminal block markers	White	Blank marker	MG-CPM 13 41791	1SNB041791R0612	1680	0.27
		Blank card	MC612	1SNK150000R0000	22	10.00
			MC612PA	1SNK159999R0000	20	11.00
Universal wire markers holder	Grey	UMH	1SNK900611R0000	10	0.20	

Complete list of accessories is indicated in the terminal block datasheet including end stops. Some accessories such as jumper bars may modify the terminal block's ratings: Complete information available in the accessories section of the catalog.

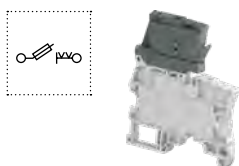

### Fuse screw clamp terminal blocks

Description	Color	Type	Part Number	Pkg qty	Weight (1 pce) g
Fuse	Grey, dark grey	ZS4-SF	1SNK506410R0000	50	18.60

Technical data valid for copper conductors only.

# ZS10-SF screw clamp terminal blocks

For 6.3x32 fuses - 8 mm 0.315 in spacing

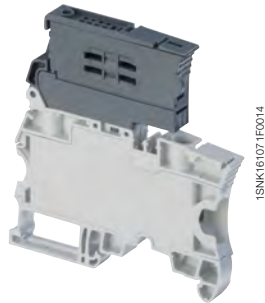

ZS10-SF

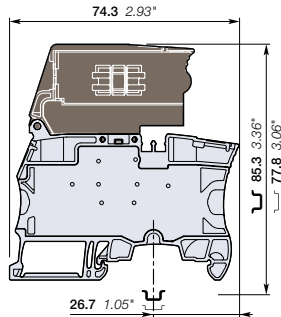

8 mm 0.315 in spacing

## Description

- Protect your circuits with 6.3x32 (1/4 x 1/4 in) fuse terminal blocks compliant with IEC 60947-7-3 standard (fuse not supplied with the terminal blocks),
- Simplify the distribution thanks to the two jumper channels.

## Ordering details

Description	Color	Type	Part Number	Pkg qty	Weight (1 pce) g
Fuse Closed block	Grey, dark grey	ZS10-SF	1SNK508418R0000	50	28.50

## Main technical data

Connecting capacity		IEC	UL - CSA	Mounting instructions	
1 conductor per clamp	Rigid: Solid/Stranded	0.5 ... 10 mm <sup>2</sup>	24 ... 6 AWG	Rail	TH 35-7.5, TH 35-15
	Flexible without ferrule	0.5 ... 10 mm <sup>2</sup>		Wire stripping length	13 mm 0.512 in
	Flexible with non insulated ferrule	0.5 ... 10 mm <sup>2</sup>	24 ... 8 AWG		
	Flexible with insulated ferrule	0.5 ... 6 mm <sup>2</sup>	24 ... 10 AWG		
Gauge		A5-B5			
2 conductors per clamp	Rigid: Solid/Stranded	0.5 ... 4 mm <sup>2</sup>	20 ... 12 AWG	Tool	Flat screwdriver Ø 4 mm Ø 0.157 in
	Flexible without ferrule	0.5 ... 4 mm <sup>2</sup>	20 ... 12 AWG		
	Flexible with twin ferrule	0.5 ... 4 mm <sup>2</sup>	20 ... 12 AWG		
Rated current / Rated cross section		10 A / 10 mm <sup>2</sup>	22 A / 6 AWG		
Rated voltage		630 V	600 V	Torque	1.3 Nm ± 0.3 11.5 lb.in ± 2.65
Impulse withstand voltage		6000 V			
Protection		IP20	NEMA 1		

Mount your fuse safely without touching any active part: put the fuse into the hooks of the fuse holder shutter; at the closing of the shutter, the fuse is perfectly in place in the fuse holder.

Separate arrangement		Assembly composed of 1 fuse terminal block in between non fuse terminal blocks	Overload and short-circuit protection	4 W
			Exclusive short-circuit protection	4 W
Compound arrangement		Assembly composed of 5 fuse terminal blocks	Overload and short-circuit protection	2.5 W
			Exclusive short-circuit protection	2.5 W

The connecting capacity data for one Rigid: Solid/Stranded, or one Flexible conductor (when applicable) is a mandatory information required by IEC, UL and CSA standards (Copper conductors). All other data are provided as supplementary information only. For more details, please consult our CB, UL or CSA certificates and technical datasheet available on <http://www.TE.com>

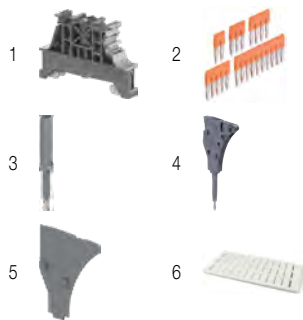
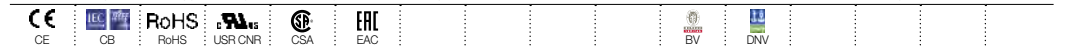

## Accessories

Description	Color	Type	Part Number	Pkg qty	Weight (1 pce) g
1 End stops	Dark grey	BAM4	1SNK900001R0000	50	14.00
2 Jumper bars	Orange	JB8-2	1SNK908302R0000	50	2.70
		JB8-3	1SNK908303R0000	50	4.10
		JB8-4	1SNK908304R0000	50	5.60
		JB8-5	1SNK908305R0000	40	7.00
		JB8-10	1SNK908310R0000	20	14.20
3 Test adapters	Dark grey	TP2	1SNK900203R0000	20	1.70
		TP4	1SNK900205R0000	20	2.40
4 Test connectors	Dark grey	TC5	1SNK900200R0000	10	5.20
		TC5-R1	1SNK900201R0000	10	5.20
5 Spacers	Dark grey	ES-TC8	1SNK900104R0000	10	1.40
		MG-CPM 13 41791	1SNB041791R0612	1680	0.27
6 Terminal block markers	White	MC812	1SNK160000R0000	22	10.00
		MC812PA	1SNK169999R0000	20	14.00
		Universal wire markers holder	Grey	UMH	1SNK900611R0000

Complete list of accessories is indicated in the terminal block datasheet including end stops. Some accessories such as jumper bars may modify the terminal block's ratings. Complete information available in the accessories section of the catalog.

Technical data valid for copper conductors only.



# ZS10-SF-R screw clamp terminal blocks

For 6.3x32 fuses - with blown fuse indicator - 8 mm 0.315 in spacing



ZS10-SF-R

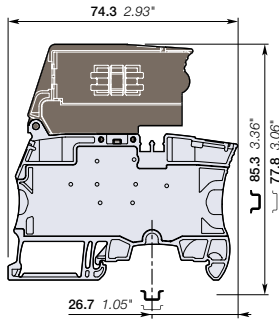

8 mm 0.315 in spacing

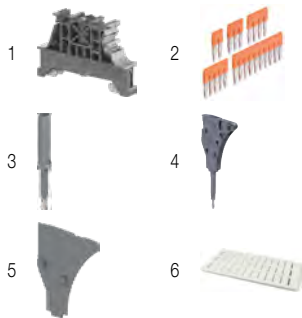

## Description

- Protect your circuits with 6.3x32 (¼ x 1¼ in) fuse terminal blocks compliant with IEC 60947-7-3 standard (fuse not supplied with the terminal blocks),
- Quickly identify the defective circuit thanks to the blown fuse indicator (with leakage current < 0.5 mA).

## Ordering details

Description	Color	Type	Part Number	Pkg qty	Weight (1 pce) g
Fuse With blown fuse indicator 115 ... 250 V AC / DC	Grey, dark grey	ZS10-SF-R3	1SNK508422R0000	50	30.50
With blown fuse indicator 24 ... 110 V AC / DC		ZS10-SF-R1	1SNK508421R0000	50	30.50

## Main technical data

Connecting capacity	IEC	UL - CSA	Mounting instructions
<b>1 conductor per clamp</b>	Rigid: Solid/Stranded Flexible without ferrule Flexible with non insulated ferrule Flexible with insulated ferrule Gauge	0.5 ... 10 mm <sup>2</sup> 0.5 ... 10 mm <sup>2</sup> 0.5 ... 10 mm <sup>2</sup> 0.5 ... 6 mm <sup>2</sup> A5-B5	24 ... 6 AWG 24 ... 8 AWG 24 ... 10 AWG
<b>2 conductors per clamp</b>	Rigid: Solid/Stranded Flexible without ferrule Flexible with twin ferrule	0.5 ... 4 mm <sup>2</sup> 0.5 ... 4 mm <sup>2</sup> 0.5 ... 4 mm <sup>2</sup>	20 ... 12 AWG 20 ... 12 AWG
<b>Rated current / Rated cross section</b>		10 A / 10 mm <sup>2</sup> 22 A / 6 AWG	
<b>Rated voltage</b>	630 V	600 V	
<b>Impulse withstand voltage</b>	6000 V		
<b>Protection</b>	IP20	NEMA 1	

Mount your fuse safely without touching any active part: put the fuse into the hooks of the fuse holder shutter; at the closing of the shutter, the fuse is perfectly in place in the fuse holder.

Separate arrangement		Assembly composed of 1 fuse terminal block in between non fuse terminal blocks	Overload and short-circuit protection	4 W
			Exclusive short-circuit protection	4 W
Compound arrangement		Assembly composed of 5 fuse terminal blocks	Overload and short-circuit protection	2.5 W
			Exclusive short-circuit protection	2.5 W

The connecting capacity data for one Rigid: Solid/Stranded, or one Flexible conductor (when applicable) is a mandatory information required by IEC, UL and CSA standards (Copper conductors). All other data are provided as supplementary information only. For more details, please consult our CB, UL or CSA certificates and technical datasheet available on <http://www.TE.com>

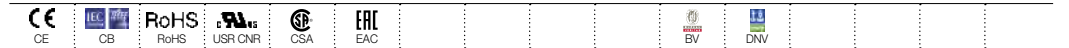

## Accessories

Description	Color	Type	Part Number	Pkg qty	Weight (1 pce) g	
<b>1 End stops</b>	Dark grey	BAM4	1SNK900001R0000	50	14.00	
<b>2 Jumper bars</b>	Orange	2 poles	JB8-2	1SNK908302R0000	50	2.70
		3 poles	JB8-3	1SNK908303R0000	50	4.10
		4 poles	JB8-4	1SNK908304R0000	50	5.60
		5 poles	JB8-5	1SNK908305R0000	40	7.00
		10 poles	JB8-10	1SNK908310R0000	20	14.20
		<b>3 Test adapters</b>	Dark grey	For test plugs DIA 2 mm 0.079 in	TP2	1SNK900203R0000
For test plugs DIA 4 mm 0.157 in	TP4			1SNK900205R0000	20	2.40
<b>4 Test connectors</b>	Dark grey	5.2 mm 0.205 in spacing	TC5	1SNK900200R0000	10	5.20
		End module, 5.2 mm 0.205 in	TC5-R1	1SNK900201R0000	10	5.20
<b>5 Spacers</b>	Dark grey	ES-TC8	1SNK900104R0000	10	1.40	
<b>6 Terminal block markers</b>	White	Blank marker	MG-CPM 13 41791	1SNB041791R0612	1680	0.27
		Blank card	MC812	1SNK160000R0000	22	10.00
			MC812PA	1SNK169999R0000	20	14.00
		Universal wire markers holder	Grey	UMH	1SNK900611R0000	10

Complete list of accessories is indicated in the terminal block datasheet including end stops. Some accessories such as jumper bars may modify the terminal block's ratings: Complete information available in the accessories section of the catalog.

Technical data valid for copper conductors only.

# ZS10-S-R2 screw clamp terminal blocks

## Disconnect with lever - 8 mm 0.315 in spacing

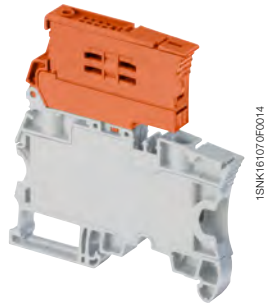
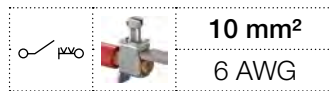

ZS10-S-R2

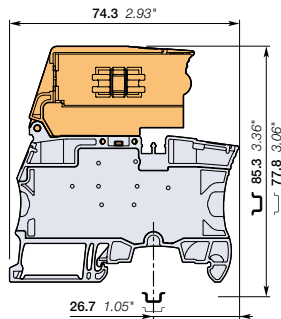

8 mm 0.315 in spacing

### Description

Simplify the disconnect operations for the disconnect terminal blocks installed next to fuse terminal blocks ZS10-SF:  
 – With the same profile as ZS10-SF, the ZS10-S-R2 disconnect lever is easily operated by hand and the wiring of the alternated disconnect and fuse circuits is easier.

### Ordering details

Description	Color	Type	Part Number	Pkg qty	Weight (1 pce) g
Disconnect Profile aligned with ZS10-SF	Grey, orange	ZS10-S-R2	1SNK508417R0000	50	35.90

### Main technical data

Connecting capacity	IEC	UL - CSA	Mounting instructions
<b>1 conductor per clamp</b>	Rigid: Solid/Stranded Flexible without ferrule Flexible with non insulated ferrule Flexible with insulated ferrule Gauge	0.5 ... 10 mm <sup>2</sup> 0.5 ... 10 mm <sup>2</sup> 0.5 ... 10 mm <sup>2</sup> 0.5 ... 6 mm <sup>2</sup> A5-B5	24 ... 6 AWG 24 ... 8 AWG 24 ... 10 AWG
<b>2 conductors per clamp</b>	Rigid: Solid/Stranded Flexible without ferrule Flexible with twin ferrule	0.5 ... 4 mm <sup>2</sup> 0.5 ... 4 mm <sup>2</sup> 0.5 ... 4 mm <sup>2</sup>	20 ... 12 AWG 20 ... 12 AWG
<b>Rated current / Rated cross section</b>		10 A / 4 mm <sup>2</sup>	22 A / 25 AWG
<b>Maximum current / Maximum cross section</b>		25 A / 10 mm <sup>2</sup>	
<b>Rated short-time withstand current (1s)</b>		480 A	
<b>Rated voltage</b>		630 V	600 V
<b>Impulse withstand voltage</b>		6000 V	
<b>Protection</b>		IP20	NEMA 1

Recommendation for best usage: in horizontal assemblies, disconnect terminal blocks should be mounted with fixed foot on top (power side) so that the disconnect lever does not partially close through gravity. Furthermore, as specified per IEC 60947-7-1, disconnect terminal blocks are intended to be used for temporary disconnection at zero potential and at no load.

The connecting capacity data for one Rigid: Solid/Stranded, or one Flexible conductor (when applicable) is a mandatory information required by IEC, UL and CSA standards (Copper conductors). All other data are provided as supplementary information only. For more details, please consult our CB, UL or CSA certificates and technical datasheet available on <http://www.TE.com>

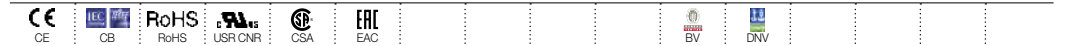

### Accessories

Description	Color	Type	Part Number	Pkg qty	Weight (1 pce) g
<b>1 End stops</b>	Dark grey	BAM4	1SNK900001R0000	50	14.00
<b>2 Jumper bars</b>	Orange	JB8-2	1SNK908302R0000	50	2.70
		JB8-3	1SNK908303R0000	50	4.10
		JB8-4	1SNK908304R0000	50	5.60
		JB8-5	1SNK908305R0000	40	7.00
		JB8-10	1SNK908310R0000	20	14.20
<b>3 Test adapters</b>	Dark grey	TP2	1SNK900203R0000	20	1.70
		TP4	1SNK900205R0000	20	2.40
<b>4 Test connectors</b>	Dark grey	TC5	1SNK900200R0000	10	5.20
		TC5-R1	1SNK900201R0000	10	5.20
<b>5 Spacers</b>	Dark grey	ES-TC8	1SNK900104R0000	10	1.40
<b>6 Terminal block markers</b>	White	MG-CPM 13 41791	1SNB041791R0612	1680	0.27
		MC812	1SNK160000R0000	22	10.00
		MC812PA	1SNK169999R0000	20	14.00
	Grey	UMH	1SNK900611R0000	10	0.20

Complete list of accessories is indicated in the terminal block datasheet including end stops. Some accessories such as jumper bars may modify the terminal block's ratings: Complete information available in the accessories section of the catalog.

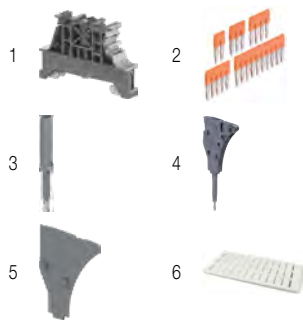

### Fuse screw clamp terminal blocks

Description	Color	Type	Part Number	Pkg qty	Weight (1 pce) g
Fuse Closed block	Grey, dark grey	ZS10-SF	1SNK508418R0000	50	28.50

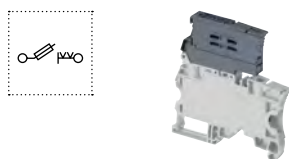

Technical data valid for copper conductors only.

# ZS4-D2 screw clamp terminal blocks

Double deck with 2 feed-through circuits - 5.2 mm 0.205 in spacing

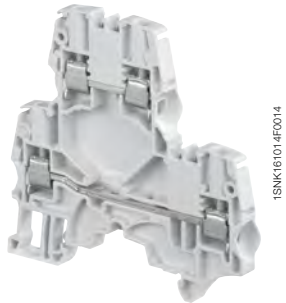
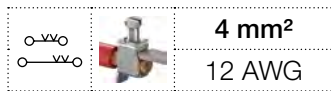

ZS4-D2

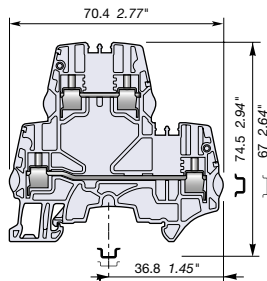

5.2 mm 0.205 in spacing

## Description

- Save space with double deck terminal blocks: 2 independent circuits connected in just 5.2 mm 0.205 in spacing,
- Customize yourself the ZS4-D2 by soldering electronic components (up to 8.8 mm x 3.2 mm 0.346 x 0.125 in) in the existing linking bars punching.

## Ordering details

Description	Color	Type	Part Number	Pkg qty	Weight (1 pce) g
Feed-through 2 feed-through circuits	Grey	ZS4-D2	1SNK505210R0000	50	15.30
	Blue	ZS4-D2-BL	1SNK505220R0000	50	15.30
	Orange	ZS4-D2-OR	1SNK505230R0000	50	15.30

## Main technical data

Connecting capacity		IEC	UL - CSA	Mounting instructions	
1 conductor per clamp	Rigid: Solid/Stranded	0.2 ... 4 mm <sup>2</sup>	24 ... 12 AWG	Rail	TH 35-7.5, TH 35-15
	Flexible without ferrule	0.22 ... 4 mm <sup>2</sup>		Wire stripping length	10 mm 0.393 in
	Flexible with non insulated ferrule	0.22 ... 4 mm <sup>2</sup>	24 ... 12 AWG		
	Flexible with insulated ferrule	0.22 ... 2.5 mm <sup>2</sup>	24 ... 14 AWG		
	Gauge	A3-B3			
2 conductors per clamp	Rigid: Solid/Stranded	0.2 ... 1.5 mm <sup>2</sup>	24 ... 16 AWG	Tool	Flat screwdriver Ø 3.5 mm Ø 0.138 in
	Flexible without ferrule	0.2 ... 1.5 mm <sup>2</sup>			
	Flexible with twin ferrule	0.22 ... 1.5 mm <sup>2</sup>	24 ... 16 AWG		
Rated current / Rated cross section		29 A / 4 mm <sup>2</sup>	20 A / 12 AWG	Torque	0.6 Nm ± 0.1 5.31 lb.in ± 0.885
Rated short-time withstand current (1s)		480 A			
Short Circuit Current Rating (with specific conditions)			100 kA		
Rated voltage		800 V	300 V		
Impulse withstand voltage		8000 V			
Protection		IP20	NEMA 1		
Increased safety Ex e		440 V 29 A IEC/EN 60079-7 - IM2 II 2 GD Ex eb I/II/III C - 300 V 20 A UL 60079-7 - Class I, Zone 1, AEx e II, Ex e II U			

The connecting capacity data for one Rigid: Solid/Stranded, or one Flexible conductor (when applicable) is a mandatory information required by IEC, UL and CSA standards (Copper conductors). All other data are provided as supplementary information only. For more details, please consult our CB, UL or CSA certificates and technical datasheet available on <http://www.TE.com>



## Accessories

Description	Color	Type	Part Number	Pkg qty	Weight (1 pce) g	
1 End stops 10 mm 0.394 in	Dark grey	BAZH1	1SNK900102R0000	20	24.00	
2 End sections 2.55 mm 0.100 in	Dark grey	ES4-D2	1SNK505960R0000	20	4.10	
3 Jumper bars 2 poles 32 A (IEC)	Orange	JB5-2	1SNK905302R0000	50	1.30	
		3 poles 32 A (IEC)	JB5-3	1SNK905303R0000	50	2.00
		4 poles 32 A (IEC)	JB5-4	1SNK905304R0000	50	2.70
		5 poles 32 A (IEC)	JB5-5	1SNK905305R0000	50	3.50
		10 poles 32 A (IEC)	JB5-10	1SNK905310R0000	30	7.10
4 Test adapters For test plugs DIA 2 mm 0.079 in	Dark grey	TP2	1SNK900203R0000	20	1.70	
		TP4	1SNK900205R0000	20	2.40	
5 Test connectors 5.2 mm 0.205 in spacing	Dark grey	TC5	1SNK900200R0000	10	5.20	
		End module, 5.2 mm 0.205 in	TC5-R1	1SNK900201R0000	10	5.20
6 Shield connectors		SHB	1SNK900602R0000	20	4.90	
7 Label holders	Dark grey	LH-J	1SNK900606R0000	100	0.73	
8 Terminal block markers	White	MG-CPM 13 41790	1SNB041790R0512	1960	0.23	
		MC512	1SNK140000R0000	22	9.00	
		MC512PA	1SNK149999R0000	20	10.00	
		Universal wire markers holder	Grey	UMH	1SNK900611R0000	10

Complete list of accessories is indicated in the terminal block datasheet including end stops.

Some accessories such as jumper bars may modify the terminal block's ratings: Complete information available in the accessories section of the catalog.

Technical data valid for copper conductors only.

# ZS4-D1 screw clamp terminal blocks

Double deck with 1 feed-through circuit - 5.2 mm 0.205 in spacing

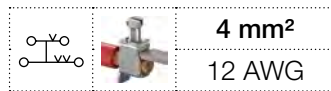

ZS4-D1

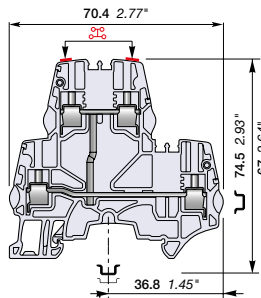

5.2 mm 0.205 in spacing

## Description

- Ease one potential distribution on 4 independent screw clamps,
- Save space by connecting conductors up to 4 mm<sup>2</sup> (CB certified) 12 AWG in just 5.2 mm 0.205 in spacing.

## Ordering details

Description	Color	Type	Part Number	Pkg qty	Weight (1 pce) g
Feed-through 1 feed-through circuit	Grey <input type="checkbox"/>	ZS4-D1	1SNK505211R0000	50	15.30

## Main technical data

Connecting capacity		IEC	UL - CSA	Mounting instructions	
1 conductor per clamp	Rigid: Solid/Stranded	0.2 ... 4 mm <sup>2</sup>	24 ... 12 AWG	Rail	TH 35-7.5, TH 35-15
	Flexible without ferrule	0.22 ... 4 mm <sup>2</sup>		Wire stripping length	10 mm 0.393 in
	Flexible with non insulated ferrule	0.22 ... 4 mm <sup>2</sup>	24 ... 12 AWG	Tool	Flat screwdriver Ø 3.5 mm Ø 0.138 in
	Flexible with insulated ferrule	0.22 ... 2.5 mm <sup>2</sup>	24 ... 14 AWG		
Gauge		A3-B3		Torque	0.6 Nm ± 0.1 5.31 lb.in ± 0.885
2 conductors per clamp	Rigid: Solid/Stranded	0.2 ... 1.5 mm <sup>2</sup>	24 ... 16 AWG		
Flexible without ferrule		0.2 ... 1.5 mm <sup>2</sup>			
Flexible with twin ferrule		0.22 ... 1.5 mm <sup>2</sup>	24 ... 16 AWG		
Rated current / Rated cross section		29 A / 4 mm <sup>2</sup>	20 A / 12 AWG		
Rated short-time withstand current (1s)		480 A			
Short Circuit Current Rating (with specific conditions)			100 kA		
Rated voltage		800 V	300 V		
Impulse withstand voltage		8000 V			
Protection		IP20	NEMA 1		

**Increased safety Ex e** 440 V 29 A IEC/EN 60079-7 - IM2 II 2 GD Ex eb I/IIIC - 300 V 20 A UL 60079-7 - Class I, Zone 1, AEx e II, Ex e II U

The connecting capacity data for one Rigid: Solid/Stranded, or one Flexible conductor (when applicable) is a mandatory information required by IEC, UL and CSA standards (Copper conductors). All other data are provided as supplementary information only. For more details, please consult our CB, UL or CSA certificates and technical datasheet available on <http://www.TE.com>

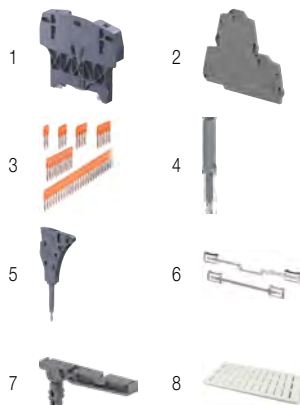

## Accessories

Description	Color	Type	Part Number	Pkg qty	Weight (1 pce) g	
1 End stops	Dark grey <input checked="" type="checkbox"/>	BAZH1	1SNK900102R0000	20	24.00	
2 End sections	Dark grey <input checked="" type="checkbox"/>	ES4-D2	1SNK505960R0000	20	4.10	
3 Jumper bars	Orange <input checked="" type="checkbox"/>	2 poles	JB5-2	1SNK905302R0000	50	1.30
		3 poles	JB5-3	1SNK905303R0000	50	2.00
		4 poles	JB5-4	1SNK905304R0000	50	2.70
		5 poles	JB5-5	1SNK905305R0000	50	3.50
		10 poles	JB5-10	1SNK905310R0000	30	7.10
4 Test adapters	Dark grey <input checked="" type="checkbox"/>	For test plugs DIA 2 mm 0.079 in	TP2	1SNK900203R0000	20	1.70
		For test plugs DIA 4 mm 0.157 in	TP4	1SNK900205R0000	20	2.40
5 Test connectors	Dark grey <input checked="" type="checkbox"/>	5.2 mm 0.205 in spacing	TC5	1SNK900200R0000	10	5.20
		End module, 5.2 mm 0.205 in	TC5-R1	1SNK900201R0000	10	5.20
6 Shield connectors		SHB	1SNK900602R0000	20	4.90	
7 Label holders	Dark grey <input checked="" type="checkbox"/>	LH-J	1SNK900606R0000	100	0.73	
8 Terminal block markers	White <input type="checkbox"/>	Blank marker	MG-CPM 13 41790	1SNB041790R0512	1960	0.23
		Blank card	MC512	1SNK140000R0000	22	9.00
			MC512PA	1SNK149999R0000	20	10.00
		Universal wire markers holder	Grey <input type="checkbox"/>	UMH	1SNK900611R0000	10

Complete list of accessories is indicated in the terminal block datasheet including end stops.

Some accessories such as jumper bars may modify the terminal block's ratings: Complete information available in the accessories section of the catalog.

Technical data valid for copper conductors only.



# ZS6-D2 screw clamp terminal blocks

Double deck with 2 feed-through circuits - 6 mm 0.236 in spacing

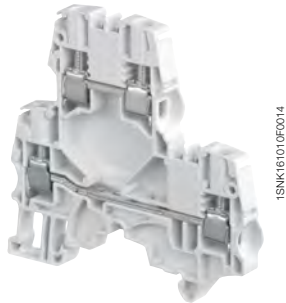

ZS6-D2

## Description

- Save space with double deck terminal blocks: 2 independent circuits connected in just 6 mm 0.236 in spacing,
- Customize yourself the ZS6-D2 by soldering electronic components (up to 8.8 mm x 3.2 mm 0.346 x 0.125 in) in the existing linking bars punching,
- Boost the performances: ZS6-D... with ES4-D2 end section is rated 1000 V DC IEC, perfectly adapted to solar applications.

## Ordering details

Description	Color	Type	Part Number	Pkg qty	Weight (1 pce) g
Feed-through 2 feed-through circuits	Grey	ZS6-D2	1SNK506210R0000	50	18.40
	Blue	ZS6-D2-BL	1SNK506220R0000	50	18.40
	Orange	ZS6-D2-OR	1SNK506230R0000	50	18.40
	Yellow	ZS6-D2-YL	1SNK506260R0000	50	18.40
	Red	ZS6-D2-RD	1SNK506262R0000	50	18.40
	White	ZS6-D2-WH	1SNK506265R0000	50	18.40
	Black	ZS6-D2-BK	1SNK506266R0000	50	18.40

## Main technical data

Connecting capacity	IEC	UL - CSA	Mounting instructions
1 conductor per clamp	Rigid: Solid/Stranded	0.2 ... 6 mm²	24 ... 10 AWG
	Flexible without ferrule	0.2 ... 6 mm²	24 ... 10 AWG
	Flexible with non insulated ferrule	0.22 ... 4 mm²	24 ... 12 AWG
	Flexible with insulated ferrule	0.22 ... 4 mm²	24 ... 12 AWG
	Gauge	A4-B3	
2 conductors per clamp	Rigid: Solid/Stranded	0.2 ... 2.5 mm²	24 ... 14 AWG
	Flexible without ferrule	0.2 ... 2.5 mm²	24 ... 14 AWG
	Flexible with twin ferrule	0.22 ... 2.5 mm²	24 ... 14 AWG
Rated current / Rated cross section	40 A / 6 mm²	30 A / 10 AWG	
Rated short-time withstand current (1s)	720 A		
Short Circuit Current Rating (with specific conditions)		100 kA	
Rated voltage	800 V	300 V	
Impulse withstand voltage	8000 V		
Protection	IP20	NEMA 1	

**Increased safety Ex e** 440 V 40 A IEC/EN 60079-7 - IM2 II 2 GD Ex eb I/II/IIIc - 300 V 30 A UL 60079-7 - Class I, Zone 1, AEx e II, Ex e II U

The connecting capacity data for one Rigid: Solid/Stranded, or one Flexible conductor (when applicable) is a mandatory information required by IEC, UL and CSA standards (Copper conductors). All other data are provided as supplementary information only. For more details, please consult our CB, UL or CSA certificates and technical datasheet available on <http://www.TE.com>

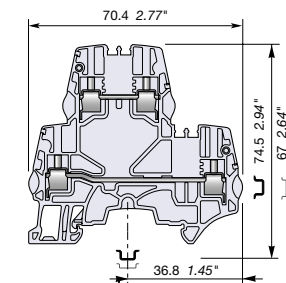

6 mm 0.236 in spacing

## Accessories

Description	Color	Type	Part Number	Pkg qty	Weight (1 pce) g	
1 End stops	Dark grey	BAZH1	1SNK900102R0000	20	24.00	
2 End sections	Dark grey	ES4-D2	1SNK505960R0000	20	4.10	
3 Jumper bars	Orange	2 poles	JB6-2	1SNK906302R0000	50	1.30
		3 poles	JB6-3	1SNK906303R0000	50	2.10
		4 poles	JB6-4	1SNK906304R0000	50	2.90
		5 poles	JB6-5	1SNK906305R0000	50	3.60
		10 poles	JB6-10	1SNK906310R0000	20	7.40
4 Test adapters	Dark grey	For test plugs DIA 2 mm 0.079 in	TP2	1SNK900203R0000	20	1.70
		For test plugs DIA 4 mm 0.157 in	TP4	1SNK900205R0000	20	2.40
5 Test connectors	Dark grey	TC5-R1	1SNK900201R0000	10	5.20	
6 Spacers	Dark grey	ES-TC6	1SNK900105R0000	10	0.80	
7 Shield connectors		SHB	1SNK900602R0000	20	4.90	
8 Terminal block markers	White	Blank marker	MG-CPM 13 41791	1SNB041791R0612	1680	0.27
		Blank card	MC612	1SNK150000R0000	22	10.00
			MC612PA	1SNK159999R0000	20	11.00
	Universal wire markers holder	Grey	UMH	1SNK900611R0000	10	0.20

Complete list of accessories is indicated in the terminal block datasheet including end stops. Some accessories such as jumper bars may modify the terminal block's ratings: Complete information available in the accessories section of the catalog.

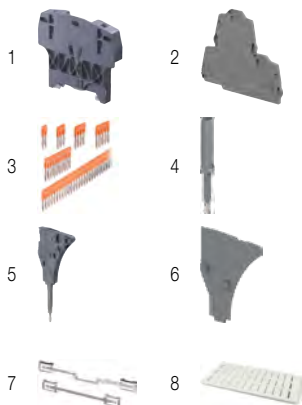

## Ground screw clamp terminal blocks

Description	Color	Type	Part Number	Pkg qty	Weight (1 pce) g
Ground Profile aligned with ZS6-D2 and ZS6-D1	Green-yellow	ZS6-D1-PE	1SNK506250R0000	20	18.40

Technical data valid for copper conductors only.



# ZS6-D1 screw clamp terminal blocks

Double deck with 1 feed-through circuit - 6 mm 0.236 in spacing

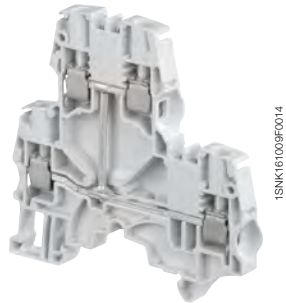
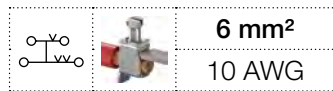

ZS6-D1

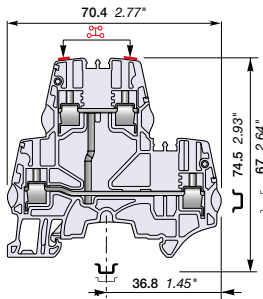

6 mm 0.236 in spacing

## Description

- Ease one potential distribution on 4 independent screw clamps,
- Save space by connecting conductors up to 6 mm<sup>2</sup> 10 AWG in just 6 mm 0.236 in spacing,
- Boost the performances: ZS6-D... with ES4-D2 end section is rated 1000 V DC IEC, perfectly adapted to solar applications.

## Ordering details

Description	Color	Type	Part Number	Pkg qty	Weight (1 pce) g
Feed-through 1 feed-through circuit	Grey <input type="checkbox"/>	ZS6-D1	1SNK506211R0000	50	18.40
	Red <input checked="" type="checkbox"/>	ZS6-D1-RD	1SNK506214R0000	50	18.40

## Main technical data

Connecting capacity		IEC	UL - CSA	Mounting instructions	
1 conductor per clamp	Rigid: Solid/Stranded	0.2 ... 6 mm <sup>2</sup>	24 ... 10 AWG	Rail	TH 35-7.5, TH 35-15
	Flexible without ferrule	0.2 ... 6 mm <sup>2</sup>		Wire stripping length	10 mm 0.393 in
	Flexible with non insulated ferrule	0.22 ... 4 mm <sup>2</sup>	24 ... 12 AWG	Tool	Flat screwdriver Ø 4 mm Ø 0.157 in
	Flexible with insulated ferrule	0.22 ... 4 mm <sup>2</sup>	24 ... 12 AWG		
Gauge		A4-B3		Torque	0.85 Nm ± 0.15 7.52 lb.in ± 1.33
2 conductors per clamp	Rigid: Solid/Stranded	0.2 ... 2.5 mm <sup>2</sup>	24 ... 14 AWG		
	Flexible without ferrule	0.2 ... 2.5 mm <sup>2</sup>			
	Flexible with twin ferrule	0.22 ... 2.5 mm <sup>2</sup>	24 ... 14 AWG		
Rated current / Rated cross section		40 A / 6 mm <sup>2</sup>	30 A / 10 AWG		
Rated short-time withstand current (1s)		720 A			
Short Circuit Current Rating (with specific conditions)			100 kA		
Rated voltage		800 V	300 V		
Impulse withstand voltage		8000 V			
Protection		IP20	NEMA 1		

**Increased safety Ex e** 440 V 40 A IEC/EN 60079-7 - IM2 II 2 GD Ex eb I/IIIC - 300 V 30 A UL 60079-7 - Class I, Zone 1, AEx e II, Ex e II U

The connecting capacity data for one Rigid: Solid/Stranded, or one Flexible conductor (when applicable) is a mandatory information required by IEC, UL and CSA standards (Copper conductors). All other data are provided as supplementary information only. For more details, please consult our CB, UL or CSA certificates and technical datasheet available on <http://www.TE.com>

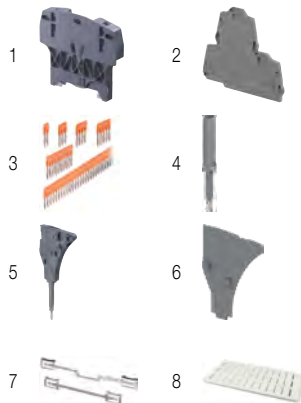

## Accessories

Description	Color	Type	Part Number	Pkg qty	Weight (1 pce) g	
1 End stops 10 mm 0.394 in	Dark grey <input checked="" type="checkbox"/>	BAZH1	1SNK900102R0000	20	24.00	
2 End sections 2.55 mm 0.100 in	Dark grey <input checked="" type="checkbox"/>	ES4-D2	1SNK505960R0000	20	4.10	
3 Jumper bars	Orange <input checked="" type="checkbox"/>	2 poles 41 A (IEC)	JB6-2	1SNK906302R0000	50	1.30
		3 poles 41 A (IEC)	JB6-3	1SNK906303R0000	50	2.10
		4 poles 41 A (IEC)	JB6-4	1SNK906304R0000	50	2.90
		5 poles 41 A (IEC)	JB6-5	1SNK906305R0000	50	3.60
		10 poles 41 A (IEC)	JB6-10	1SNK906310R0000	20	7.40
4 Test adapters	Dark grey <input checked="" type="checkbox"/>	For test plugs DIA 2 mm 0.079 in	TP2	1SNK900203R0000	20	1.70
		For test plugs DIA 4 mm 0.157 in	TP4	1SNK900205R0000	20	2.40
5 Test connectors End module, 5.2 mm 0.205 in	Dark grey <input checked="" type="checkbox"/>	TC5-R1	1SNK900201R0000	10	5.20	
6 Spacers 0.8 mm 0.031 in	Dark grey <input checked="" type="checkbox"/>	ES-TC6	1SNK900105R0000	10	0.80	
7 Shield connectors		SHB	1SNK900602R0000	20	4.90	
8 Terminal block markers	White <input type="checkbox"/>	Blank marker	MG-CPM 13 41791	1SNB041791R0612	1680	0.27
		Blank card	MC612	1SNK150000R0000	22	10.00
		Universal wire markers holder	Grey <input type="checkbox"/>	UMH	1SNK900611R0000	10

Complete list of accessories is indicated in the terminal block datasheet including end stops.

Some accessories such as jumper bars may modify the terminal block's ratings: Complete information available in the accessories section of the catalog.

Technical data valid for copper conductors only.

# ZS6-D2-PE screw clamp terminal blocks

Double deck with 1 feed-through circuit and 1 ground circuit - 6 mm 0.236 in spacing

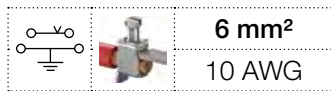

ZS6-D2-PE

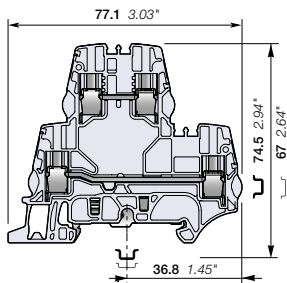

6 mm 0.236 in spacing

## Description

- Save space with ZS6-D2-PE terminal blocks: 1 feed-through circuit and 1 ground circuit in just 6 mm 0.236 in spacing,
- Customize yourself the ZS6-D2-PE terminal blocks by soldering electronic components (up to 8.8 mm x 3.2 mm 0.346 x 0.125 in) in the existing linking bars punching.

## Ordering details

Description	Color	Type	Part Number	Pkg qty	Weight (1 pce) g
Feed-through + ground	Grey	<input type="checkbox"/> ZS6-D2-PE	1SNK506212R0000	50	18.40

## Main technical data

Connecting capacity		IEC	UL - CSA	Mounting instructions	
1 conductor per clamp	Rigid: Solid/Stranded	0.2 ... 6 mm <sup>2</sup>	24 ... 10 AWG	Rail	TH 35-7.5, TH 35-15
	Flexible without ferrule	0.22 ... 6 mm <sup>2</sup>		Wire stripping length	10 mm 0.393 in
	Flexible with non insulated ferrule	0.22 ... 4 mm <sup>2</sup>	24 ... 12 AWG		
	Flexible with insulated ferrule	0.22 ... 4 mm <sup>2</sup>	24 ... 12 AWG		
	Gauge	A4-B3			
2 conductors per clamp	Rigid: Solid/Stranded	0.2 ... 2.5 mm <sup>2</sup>	24 ... 14 AWG	Tool	Flat screwdriver Ø 4 mm Ø 0.157 in
	Flexible without ferrule	0.2 ... 2.5 mm <sup>2</sup>	24 ... 14 AWG		
	Flexible with twin ferrule	0.22 ... 2.5 mm <sup>2</sup>	24 ... 14 AWG		
Rated current / Rated cross section		41 A / 6 mm <sup>2</sup>	30 A / 10 AWG	Torque	0.85 Nm ± 0.15 7.52 lb.in ± 1.33
Rated short-time withstand current (1s)		720 A			
Short Circuit Current Rating (with specific conditions)					
Rated voltage		800 V	300 V		
Impulse withstand voltage		8000 V			
Protection		IP20	NEMA 1		

The connecting capacity data for one Rigid: Solid/Stranded, or one Flexible conductor (when applicable) is a mandatory information required by IEC, UL and CSA standards (Copper conductors). All other data are provided as supplementary information only. For more details, please consult our CB, UL or CSA certificates and technical datasheet available on <http://www.TE.com>

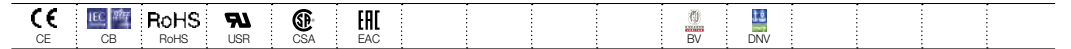

## Accessories

Description	Color	Type	Part Number	Pkg qty	Weight (1 pce) g	
1 End stops	Dark grey	BZH1	1SNK900102R0000	20	24.00	
2 End sections	Dark grey	ES4-D2	1SNK505960R0000	20	4.10	
3 Jumper bars	Orange	2 poles	JB6-2	1SNK906302R0000	50	1.30
		3 poles	JB6-3	1SNK906303R0000	50	2.10
		4 poles	JB6-4	1SNK906304R0000	50	2.90
		5 poles	JB6-5	1SNK906305R0000	50	3.60
		10 poles	JB6-10	1SNK906310R0000	20	7.40
4 Test adapters	Dark grey	TP4	1SNK900205R0000	20	2.40	
5 Test connectors	Dark grey	TC5-R1	1SNK900201R0000	10	5.20	
6 Spacers	Dark grey	ES-TC6	1SNK900105R0000	10	0.80	
7 Terminal block markers	White	Blank marker	MG-CPM 13 41791	1SNB041791R0612	1680	0.27
		Blank card	MC612	1SNK150000R0000	22	10.00
			MC612PA	1SNK159999R0000	20	11.00
	Universal wire markers holder	Grey	UMH	1SNK900611R0000	10	0.20

Complete list of accessories is indicated in the terminal block datasheet including end stops. Some accessories such as jumper bars may modify the terminal block's ratings: Complete information available in the accessories section of the catalog.

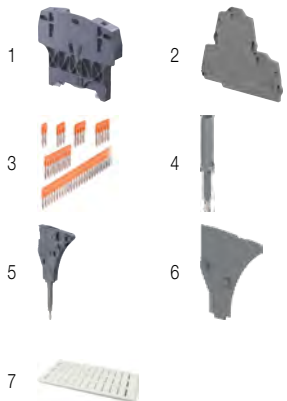

## Feed-through screw clamp terminal blocks

Description	Color	Type	Part Number	Pkg qty	Weight (1 pce) g
Feed-through	Grey	<input type="checkbox"/> ZS6-D2	1SNK506210R0000	50	18.40



Technical data valid for copper conductors only.

# ZS6-D1-PE screw clamp terminal blocks

Double deck with 1 ground circuit - 6 mm 0.236 in spacing

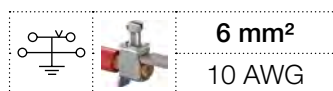

ZS6-D1-PE

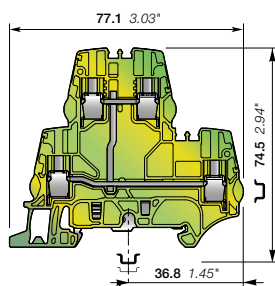

6 mm 0.236 in spacing

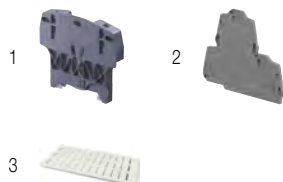

## Description

- Save space with double deck ground terminal blocks aligned with ZS6-D2 double deck terminal blocks for convenient cabling process and circuit configuration,
- Benefit from our screwless rail connection: non operator independant, secured snap on or remove from the rail, performances above the requirements of IEC 60947-7-2 standard.

## Ordering details

Description	Color	Type	Part Number	Pkg qty	Weight (1 pce) g
Ground 1 ground circuit	Green-yellow	ZS6-D1-PE	1SNK506250R0000	20	18.40

## Main technical data

Connecting capacity		IEC	UL - CSA	Mounting instructions	
1 conductor per clamp	Rigid: Solid/Stranded	0.2 ... 6 mm <sup>2</sup>	24 ... 10 AWG	Rail	TH 35-7.5, TH 35-15
	Flexible without ferrule	0.22 ... 6 mm <sup>2</sup>		Wire stripping length	10 mm 0.393 in
	Flexible with non insulated ferrule	0.22 ... 4 mm <sup>2</sup>	24 ... 12 AWG		
	Flexible with insulated ferrule	0.22 ... 4 mm <sup>2</sup>	24 ... 12 AWG	Tool	Flat screwdriver Ø 4 mm Ø 0.157 in
	Gauge	A4-B3			
Rated cross section		6 mm <sup>2</sup>	10 AWG	Torque	0.85 Nm ± 0.15 7.52 lb.in ± 1.33
Rated short-time withstand current (1s)		720 A			
Protection		IP20	NEMA 1		

The connecting capacity data for one Rigid: Solid/Stranded, or one Flexible conductor (when applicable) is a mandatory information required by IEC, UL and CSA standards (Copper conductors). All other data are provided as supplementary information only. For more details, please consult our CB, UL or CSA certificates and technical datasheet available on <http://www.TE.com>

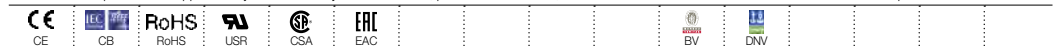

## Accessories

Description	Color	Type	Part Number	Pkg qty	Weight (1 pce) g
1 End stops	Dark grey	BAZH1	1SNK900102R0000	20	24.00
2 End sections	Dark grey	ES4-D2	1SNK505960R0000	20	4.10
3 Terminal block markers	White	MG-CPM 13 41791	1SNB041791R0612	1680	0.27
		MC612	1SNK150000R0000	22	10.00
		MC612PA	1SNK159999R0000	20	11.00
Universal wire markers holder	Grey	UMH	1SNK900611R0000	10	0.20

Complete list of accessories is indicated in the terminal block datasheet including end stops. Some accessories such as jumper bars may modify the terminal block's ratings: Complete information available in the accessories section of the catalog.

Technical data valid for copper conductors only.

# ZS4-D2-S screw clamp terminal blocks

Double deck with 1 disconnect circuit and 1 feed-through circuit - 5.2 mm 0.205 in spacing



ZS4-D2-S

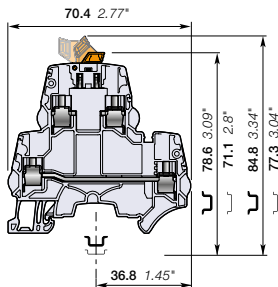

5.2 mm 0.205 in spacing

## Description

- Save space: connect one complete circuit on a single block featuring disconnect and feed-through for the return circuit in just 5.2 mm 0.205 in spacing,
- Same profile as ZS4-D... double deck terminal blocks: convenient cabling process, aligned jumpers, markers and common end section.

## Ordering details

Description	Color	Type	Part Number	Pkg qty	Weight (1 pce) g
Feed-through + disconnect	Grey <input type="checkbox"/>	ZS4-D2-S	1SNK505315R0000	50	15.90

## Main technical data

Connecting capacity		IEC	UL - CSA	Mounting instructions	
1 conductor per clamp	Rigid: Solid/Stranded	0.2 ... 4 mm <sup>2</sup>	24 ... 10 AWG	Rail	TH 35-7.5, TH 35-15
	Flexible without ferrule	0.22 ... 4 mm <sup>2</sup>		Wire stripping length	10.5 mm 0.413 in
	Flexible with non insulated ferrule	0.22 ... 4 mm <sup>2</sup>	24 ... 12 AWG		
	Flexible with insulated ferrule	0.22 ... 2.5 mm <sup>2</sup>	24 ... 14 AWG		
	Gauge	A3-B3			
2 conductors per clamp	Rigid: Solid/Stranded	0.2 ... 1.5 mm <sup>2</sup>	24 ... 16 AWG	Tool	Flat screwdriver Ø 3.5 mm Ø 0.138 in
	Flexible without ferrule	0.2 ... 1.5 mm <sup>2</sup>			
	Flexible with twin ferrule	0.22 ... 1.5 mm <sup>2</sup>	24 ... 16 AWG		
Disconnect circuit				Torque	0.6 Nm ± 0.1 5.31 lb.in ± 0.885
Rated current / Rated cross section		25 A / 4 mm <sup>2</sup>	27 A / 10 AWG		
Feed-through circuit					
Rated current / Rated cross section		29 A / 4 mm <sup>2</sup>	27 A / 10 AWG		
Rated short-time withstand current (1s)		480 A			
Rated voltage		630 V	300 V		
Impulse withstand voltage		8000 V			
Protection		IP20	NEMA 1		

Recommendation for best usage: in horizontal assemblies, disconnect terminal blocks should be mounted with fixed foot on top (power side) so that the disconnect knife does not partially close through gravity. Furthermore, as specified per IEC 60947-7-1, disconnect terminal blocks are intended to be used for temporary disconnection at zero potential and at no load.

The connecting capacity data for one Rigid: Solid/Stranded, or one Flexible conductor (when applicable) is a mandatory information required by IEC, UL and CSA standards (Copper conductors). All other data are provided as supplementary information only. For more details, please consult our CB, UL or CSA certificates and technical datasheet available on <http://www.TE.com>

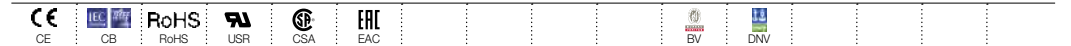

## Accessories

Description	Color	Type	Part Number	Pkg qty	Weight (1 pce) g	
1 End stops	Dark grey <input type="checkbox"/>	BAZH1	1SNK900102R0000	20	24.00	
2 End sections	Dark grey <input type="checkbox"/>	ES4-D2	1SNK505960R0000	20	4.10	
3 Jumper bars	Orange <input type="checkbox"/>	2 poles	JB5-2	1SNK905302R0000	50	1.30
		3 poles	JB5-3	1SNK905303R0000	50	2.00
		4 poles	JB5-4	1SNK905304R0000	50	2.70
		5 poles	JB5-5	1SNK905305R0000	50	3.50
		10 poles	JB5-10	1SNK905310R0000	30	7.10
		50 poles	JB5-50	1SNK905350R0000	10	36.00
4 Test adapters	Dark grey <input type="checkbox"/>	For test plugs DIA 2 mm 0.079 in	TP2	1SNK900203R0000	20	1.70
		For test plugs DIA 4 mm 0.157 in	TP4	1SNK900205R0000	20	2.40
5 Shield connectors		SHB	1SNK900602R0000	20	4.90	
6 Terminal block markers	White <input type="checkbox"/>	Blank marker	MG-CPM 13 41790	1SNB041790R0512	1960	0.23
		Blank card	MC512	1SNK140000R0000	22	9.00
			MC512PA	1SNK149999R0000	20	10.00
		Universal wire markers holder	Grey <input type="checkbox"/>	UMH	1SNK900611R0000	10

Complete list of accessories is indicated in the terminal block datasheet including end stops. Some accessories such as jumper bars may modify the terminal block's ratings: Complete information available in the accessories section of the catalog.

Technical data valid for copper conductors only.

# ZS4-D2-S-T screw clamp terminal blocks

Double deck with 1 disconnect circuit with test socket screws and 1 feed-through circuit - 5.2 mm 0.205 in spacing

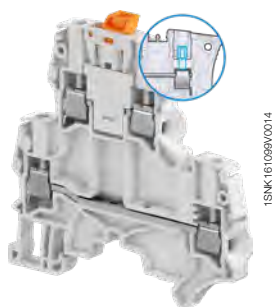
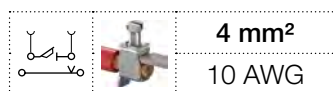

ZS4-D2-S-T

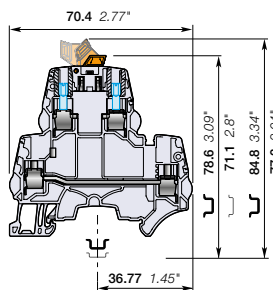

5.2 mm 0.205 in spacing

## Description

Find the same functionalities as ZS4-D2-S, upgraded with the two built-in test socket screws meant to ease your signal testing during commissioning and maintenance.

## Ordering details

Description	Color	Type	Part Number	Pkg qty	Weight (1 pce)
Feed-through + disconnect	Grey <input type="checkbox"/>	ZS4-D2-S-T2	1SNK505316R0000	50	16.20 g

## Main technical data

Connecting capacity		IEC	UL - CSA	Mounting instructions	
1 conductor per clamp	Rigid: Solid/Stranded	0.2 ... 4 mm <sup>2</sup>	24 ... 10 AWG	Rail	TH 35-7.5, TH 35-15
	Flexible without ferrule	0.22 ... 4 mm <sup>2</sup>	24 ... 12 AWG	Wire stripping length	10.5 mm 0.413 in
	Flexible with non insulated ferrule	0.22 ... 4 mm <sup>2</sup>	24 ... 12 AWG		
	Flexible with insulated ferrule	0.22 ... 2.5 mm <sup>2</sup>	24 ... 14 AWG		
Gauge		A3-B3		Tool	Flat screwdriver Ø 3.5 mm Ø 0.138 in
2 conductors per clamp	Rigid: Solid/Stranded	0.2 ... 1.5 mm <sup>2</sup>	24 ... 16 AWG		
	Flexible without ferrule	0.2 ... 1.5 mm <sup>2</sup>	24 ... 16 AWG		
	Flexible with twin ferrule	0.22 ... 1.5 mm <sup>2</sup>	24 ... 16 AWG		
Disconnect circuit				Torque	0.6 Nm ± 0.1 5.31 lb.in ± 0.885
Rated current / Rated cross section		25 A / 4 mm <sup>2</sup>	27 A / 10 AWG		
Feed-through circuit					
Rated current / Rated cross section		29 A / 4 mm <sup>2</sup>	27 A / 10 AWG		
Rated short-time withstand current (1s)		480 A			
Rated voltage		630 V	300 V		
Impulse withstand voltage		8000 V			
Protection		IP20	NEMA 1		

Recommendation for best usage: in horizontal assemblies, disconnect terminal blocks should be mounted with fixed foot on top (power side) so that the disconnect knife does not partially close through gravity. Furthermore, as specified per IEC 60947-7-1, disconnect terminal blocks are intended to be used for temporary disconnection at zero potential and at no load.

The connecting capacity data for one Rigid: Solid/Stranded, or one Flexible conductor (when applicable) is a mandatory information required by IEC, UL and CSA standards (Copper conductors). All other data are provided as supplementary information only. For more details, please consult our CB, UL or CSA certificates and technical datasheet available on <http://www.TE.com>



## Accessories

Description	Color	Type	Part Number	Pkg qty	Weight (1 pce)	
1 End stops	Dark grey <input checked="" type="checkbox"/>	BAZH1	1SNK900102R0000	20	24.00 g	
2 End sections	Dark grey <input checked="" type="checkbox"/>	ES4-D2	1SNK505960R0000	20	4.10 g	
3 Jumper bars	Orange <input checked="" type="checkbox"/>	2 poles	JB5-2	1SNK905302R0000	50	1.30 g
		3 poles	JB5-3	1SNK905303R0000	50	2.00 g
		4 poles	JB5-4	1SNK905304R0000	50	2.70 g
		5 poles	JB5-5	1SNK905305R0000	50	3.50 g
		10 poles	JB5-10	1SNK905310R0000	30	7.10 g
		50 poles	JB5-50	1SNK905350R0000	10	36.00 g
4 Test adapters	Dark grey <input checked="" type="checkbox"/>	For test plugs DIA 2 mm 0.079 in	TP2	1SNK900203R0000	20	1.70 g
		For test plugs DIA 4 mm 0.157 in	TP4	1SNK900205R0000	20	2.40 g
5 Shield connectors		SHB	1SNK900602R0000	20	4.90 g	
6 Terminal block markers	White <input type="checkbox"/>	Blank marker	MG-CPM 13 41790	1960	0.23 g	
		Blank card	MC512	1SNK140000R0000	22	9.00 g
			MC512PA	1SNK149999R0000	20	10.00 g
	Universal wire markers holder	Grey <input type="checkbox"/>	UMH	1SNK900611R0000	10	0.20 g

Complete list of accessories is indicated in the terminal block datasheet including end stops.

Some accessories such as jumper bars may modify the terminal block's ratings: Complete information available in the accessories section of the catalog.

Technical data valid for copper conductors only.



# ZS4-D2-SF1 screw clamp terminal blocks

Double deck with 1 fuse circuit and 1 feed-through circuit - 8 mm 0.315 in spacing



ZS4-D2-SF1

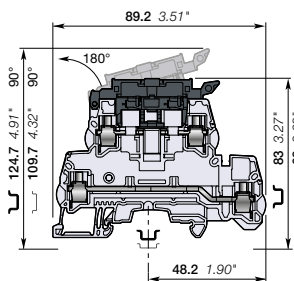

8 mm 0.315 in spacing

## Description

- Save space: connect one complete circuit on a single block featuring fuse and feed-through for the return circuit,
- Protect your circuit with either 5X20 or 5X25 fuse (fuse not supplied with the terminal blocks),
- High performances product: compliant with IEC 60947-7-3 standard and jumper channel for the feed-through circuit.

## Ordering details

Description	Color	Type	Part Number	Pkg qty	Weight (1 pce)
<b>Feed-through + fuse</b>	1 fuse circuit and 1 feed-through circuit	Grey, dark grey	ZS4-D2-SF1	1SNK508425R0000	50 27.50

## Main technical data

Connecting capacity		IEC	UL - CSA	Mounting instructions	
<b>1 conductor per clamp</b>	Rigid: Solid/Stranded	0.2 ... 6 mm <sup>2</sup>	24 ... 10 AWG	Rail	 TH 35-7.5, TH 35-15
	Flexible without ferrule	0.22 ... 4 mm <sup>2</sup>	24 ... 10 AWG		
	Flexible with non insulated ferrule	0.22 ... 4 mm <sup>2</sup>	24 ... 12 AWG	Wire stripping length	 11 mm 0.433 in
	Flexible with insulated ferrule	0.22 ... 4 mm <sup>2</sup>	24 ... 12 AWG		
Gauge		A3-B3		Tool	 Flat screwdriver Ø 3.5 mm Ø 0.138 in
<b>2 conductors per clamp</b>	Rigid: Solid/Stranded	0.2 ... 2.5 mm <sup>2</sup>	24 ... 14 AWG		
	Flexible without ferrule	0.2 ... 2.5 mm <sup>2</sup>	24 ... 14 AWG		
	Flexible with twin ferrule	0.22 ... 2.5 mm <sup>2</sup>	24 ... 14 AWG		
<b>Disconnect circuit</b>				Torque	 0.6 Nm ± 0.1 5.31 lb.in ± 0.885
<b>Rated current / Rated cross section</b>		6.3 A / 4 mm <sup>2</sup>	12 A / 10 AWG		
<b>Feed-through circuit</b>					
<b>Rated current / Rated cross section</b>		32 A / 4 mm <sup>2</sup>	30 A / 10 AWG		
<b>Rated voltage</b>		800 V	300 V		
<b>Impulse withstand voltage</b>		8000 V			
<b>Protection</b>		IP20	NEMA 1		

Separate arrangement		Assembly composed of 1 fuse terminal block in between non fuse terminal blocks	Overload and short-circuit protection	2.5 W
			Exclusive short-circuit protection	4 W
Compound arrangement		Assembly composed of 5 fuse terminal blocks	Overload and short-circuit protection	1.6 W
			Exclusive short-circuit protection	4 W

The connecting capacity data for one Rigid: Solid/Stranded, or one Flexible conductor (when applicable) is a mandatory information required by IEC, UL and CSA standards (Copper conductors). All other data are provided as supplementary information only. For more details, please consult our CB, UL or CSA certificates and technical datasheet available on <http://www.TE.com>

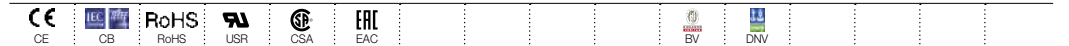

## Accessories

Description	Color	Type	Part Number	Pkg qty	Weight (1 pce)	
1 <b>End stops</b>	Dark grey	BAZH1	1SNK900102R0000	20	24.00	
2 <b>End sections</b>	Dark grey	ES4-D2-SF1	1SNK508911R0000	20	5.00	
3 <b>Jumper bars</b>	Orange	2 poles	JB8-2	1SNK908302R0000	50	2.70
		3 poles	JB8-3	1SNK908303R0000	50	4.10
		4 poles	JB8-4	1SNK908304R0000	50	5.60
		5 poles	JB8-5	1SNK908305R0000	40	7.00
		10 poles	JB8-10	1SNK908310R0000	20	14.20
4 <b>Lateral jumper bars</b>	Grey	PC81-10	1SNA173523R1100	10	5.00	
5 <b>Test adapters</b>	Dark grey	For test plugs DIA 2 mm 0.079 in	TP2	1SNK900203R0000	20	1.70
		For test plugs DIA 4 mm 0.157 in	TP4	1SNK900205R0000	20	2.40
6 <b>Test connectors</b>	Dark grey	5.2 mm 0.205 in spacing	TC5	1SNK900200R0000	10	5.20
		End module, 5.2 mm 0.205 in	TC5-R1	1SNK900201R0000	10	5.20
7 <b>Spacers</b>	Dark grey	ES-TC8	1SNK900104R0000	10	1.40	
8 <b>Assembly rods</b>		2 poles	TGA8	1SNA168672R1100	10	1.00
		3 poles	TGA8	1SNA168673R1200	10	1.50
		4 poles	TGA8	1SNA168674R1300	10	2.00
9 <b>Terminal block markers</b>	White	Blank marker	MG-CPM 13 41791	1SNB041791R0612	1680	0.27
		Blank card	MC812	1SNK160000R0000	22	10.00
			MC812PA	1SNK169999R0000	20	14.00
	Universal wire markers holder	Grey	UMH	1SNK900611R0000	10	0.20

Complete list of accessories is indicated in the terminal block datasheet including end stops. Some accessories such as jumper bars may modify the terminal block's ratings: Complete information available in the accessories section of the catalog.

Technical data valid for copper conductors only.

# ZS4-D2-SF1-R screw clamp terminal blocks

Double deck with 1 fuse circuit with blown fuse indicator and 1 feed-through circuit - 8 mm 0.315 in spacing

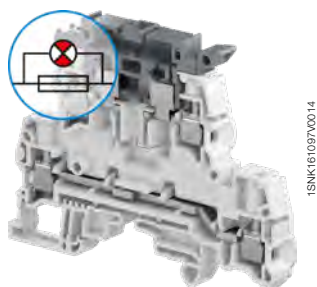

ZS4-D2-SF1-R

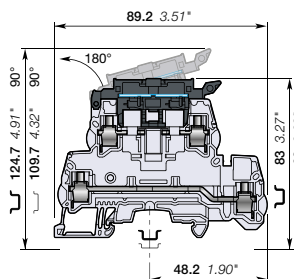

8 mm 0.315 in spacing

## Description

- Find the same functionalities as ZS4-D2-SF1, upgraded with our integrated blown fuse indicator (with leakage current < 0.5 mA),
- Only one part number needed to fit AC / DC 24 V up to 110 V.

## Ordering details

Description	Color	Type	Part Number	Pkg qty	Weight (1 pce) g
Feed-through + fuse	Grey, dark grey	ZS4-D2-SF1-R3	1SNK508424R0000	50	29.40
		ZS4-D2-SF1-R1	1SNK508423R0000	50	29.40

## Main technical data

Connecting capacity	IEC	UL - CSA	Rail	Mounting instructions
1 conductor per clamp	Rigid: Solid/Stranded	0.2 ... 6 mm <sup>2</sup>	24 ... 10 AWG	Wire stripping length
	Flexible without ferrule	0.22 ... 4 mm <sup>2</sup>	24 ... 12 AWG	
	Flexible with non insulated ferrule	0.22 ... 4 mm <sup>2</sup>	24 ... 12 AWG	
	Flexible with insulated ferrule	0.22 ... 4 mm <sup>2</sup>	24 ... 12 AWG	
Gauge		A3-B3		
2 conductors per clamp	Rigid: Solid/Stranded	0.2 ... 2.5 mm <sup>2</sup>	24 ... 14 AWG	Tool
	Flexible without ferrule	0.2 ... 2.5 mm <sup>2</sup>	24 ... 14 AWG	
	Flexible with twin ferrule	0.22 ... 2.5 mm <sup>2</sup>	24 ... 14 AWG	
Disconnect circuit				
Rated current / Rated cross section		6.3 A / 4 mm <sup>2</sup>	12 A / 10 AWG	
Feed-through circuit				
Rated current / Rated cross section		32 A / 4 mm <sup>2</sup>	30 A / 10 AWG	Torque
Rated voltage		800 V	300 V	
Impulse withstand voltage		8000 V		
Protection		IP20	NEMA 1	

Separate arrangement	Assembly composed of 1 fuse terminal block in between non fuse terminal blocks	Overload and short-circuit protection	2.5 W
		Exclusive short-circuit protection	4 W
Compound arrangement	Assembly composed of 5 fuse terminal blocks	Overload and short-circuit protection	1.6 W
		Exclusive short-circuit protection	4 W

The connecting capacity data for one Rigid: Solid/Stranded, or one Flexible conductor (when applicable) is a mandatory information required by IEC, UL and CSA standards (Copper conductors). All other data are provided as supplementary information only. For more details, please consult our CB, UL or CSA certificates and technical datasheet available on <http://www.TE.com>

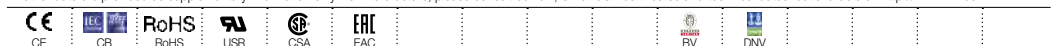

## Accessories

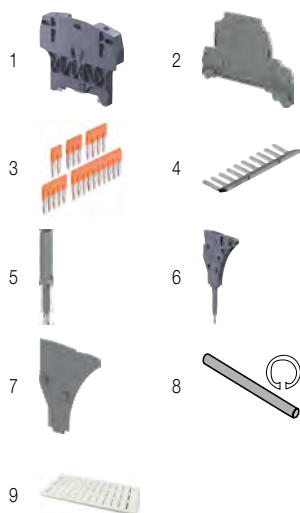

Description	Color	Type	Part Number	Pkg qty	Weight (1 pce) g	
1 End stops	Dark grey	BAZH1	1SNK900102R0000	20	24.00	
2 End sections	Dark grey	ES4-D2-SF1	1SNK508911R0000	20	5.00	
3 Jumper bars	Orange	2 poles	JB8-2	1SNK908302R0000	50	2.70
		3 poles	JB8-3	1SNK908303R0000	50	4.10
		4 poles	JB8-4	1SNK908304R0000	50	5.60
		5 poles	JB8-5	1SNK908305R0000	40	7.00
		10 poles	JB8-10	1SNK908310R0000	20	14.20
4 Lateral jumper bars	Grey	PC81-10	1SNA173523R1100	10	5.00	
5 Test adapters	Dark grey	For test plugs DIA 2 mm 0.079 in	TP2	1SNK900203R0000	20	1.70
		For test plugs DIA 4 mm 0.157 in	TP4	1SNK900205R0000	20	2.40
			TP5	1SNK900200R0000	10	5.20
6 Test connectors	Dark grey	5.2 mm 0.205 in spacing	TC5-R1	1SNK900201R0000	10	5.20
		End module, 5.2 mm 0.205 in				
7 Spacers	Dark grey	ES-TC8	1SNK900104R0000	10	1.40	
8 Assembly rods	Dark grey	2 poles	TGA8	1SNA168672R1100	10	1.00
		3 poles	TGA8	1SNA168673R1200	10	1.50
		4 poles	TGA8	1SNA168674R1300	10	2.00
9 Terminal block markers	White	Blank marker	MG-CPM 13 41791	1SNB041791R0612	1680	0.27
		Blank card	MC812	1SNK160000R0000	22	10.00
			MC812PA	1SNK169999R0000	20	14.00
		Universal wire markers holder	UMH	1SNK900611R0000	10	0.20

Complete list of accessories is indicated in the terminal block datasheet including end stops.

Some accessories such as jumper bars may modify the terminal block's ratings: Complete information available in the accessories section of the catalog.

Technical data valid for copper conductors only.

# ZS4-T3 screw clamp terminal blocks

Triple deck with 3 feed-through circuits - 5.2 mm 0.205 in spacing

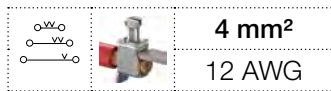

ZS4-T3

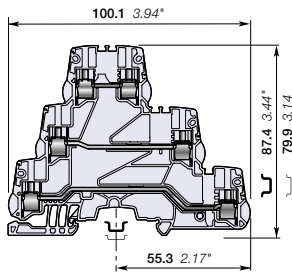

5.2 mm 0.205 in spacing

## Description

Save space: 3 independent circuits in just 5.2 mm 0.205 in spacing,

- Fit many applications: space constraints, multiple signals distribution, sensors distribution, thanks to the jumper channels available on each deck.

## Ordering details

Description	Color	Type	Part Number	Pkg qty	Weight (1 pce) g
Feed-through 3 feed-through circuits	Grey <input type="checkbox"/>	ZS4-T3	1SNK505212R0000	25	24.40

## Main technical data

Connecting capacity		IEC	UL - CSA	Mounting instructions	
1 conductor per clamp	Rigid: Solid/Stranded	0.2 ... 4 mm <sup>2</sup>	24 ... 12 AWG	Rail	TH 35-7.5, TH 35-15
	Flexible without ferrule	0.22 ... 4 mm <sup>2</sup>		Wire stripping length	10.5 mm 0.413 in
	Flexible with non insulated ferrule	0.22 ... 4 mm <sup>2</sup>	24 ... 12 AWG		
	Flexible with insulated ferrule	0.22 ... 2.5 mm <sup>2</sup>	24 ... 14 AWG		
Gauge		A3-B3		Tool	Flat screwdriver Ø 3.5 mm Ø 0.138 in
2 conductors per clamp	Rigid: Solid/Stranded	0.2 ... 1.5 mm <sup>2</sup>	24 ... 16 AWG		
	Flexible without ferrule	0.2 ... 1.5 mm <sup>2</sup>			
	Flexible with twin ferrule	0.22 ... 1.5 mm <sup>2</sup>	24 ... 16 AWG		
Rated current / Rated cross section		32 A / 4 mm <sup>2</sup>	20 A / 12 AWG	Torque	0.6 Nm ± 0.1 5.31 lb.in ± 0.885
Rated short-time withstand current (1s)		480 A			
Rated voltage		800 V	300 V		
Impulse withstand voltage		8000 V			
Protection		IP20	NEMA 1		

The connecting capacity data for one Rigid: Solid/Stranded, or one Flexible conductor (when applicable) is a mandatory information required by IEC, UL and CSA standards (Copper conductors). All other data are provided as supplementary information only. For more details, please consult our CB, UL or CSA certificates and technical datasheet available on <http://www.TE.com>

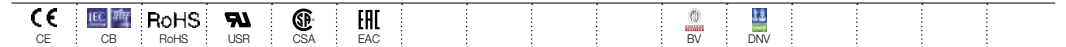

## Accessories

Description	Color	Type	Part Number	Pkg qty	Weight (1 pce) g	
1 End stops 10 mm 0.394 in	Dark grey <input checked="" type="checkbox"/>	BAZH1	1SNK900102R0000	20	24.00	
2 End sections 0.8 mm 0.031 in	Dark grey <input checked="" type="checkbox"/>	ES4-T3	1SNK505961R0000	20	4.20	
3 Jumper bars	Orange <input checked="" type="checkbox"/>	2 poles 32 A (IEC)	JB5-2	1SNK905302R0000	50	1.30
		3 poles 32 A (IEC)	JB5-3	1SNK905303R0000	50	2.00
		4 poles 32 A (IEC)	JB5-4	1SNK905304R0000	50	2.70
		5 poles 32 A (IEC)	JB5-5	1SNK905305R0000	50	3.50
		10 poles 32 A (IEC)	JB5-10	1SNK905310R0000	30	7.10
		50 poles 32 A (IEC)	JB5-50	1SNK905350R0000	10	36.00
4 Test adapters	Dark grey <input checked="" type="checkbox"/>	For test plugs DIA 2 mm 0.079 in	TP2	1SNK900203R0000	20	1.70
		For test plugs DIA 4 mm 0.157 in	TP4	1SNK900205R0000	20	2.40
5 Label holders	Dark grey <input checked="" type="checkbox"/>	LH-J	1SNK900606R0000	100	0.73	
6 Terminal block markers	White <input type="checkbox"/>	Blank marker	MG-CPM 13 41790	1SNB041790R0512	1960	0.23
		Blank card	MC512	1SNK140000R0000	22	9.00
			MC512PA	1SNK149999R0000	20	10.00
		Universal wire markers holder	Grey <input type="checkbox"/>	UMH	1SNK900611R0000	10

Complete list of accessories is indicated in the terminal block datasheet including end stops.

Some accessories such as jumper bars may modify the terminal block's ratings: Complete information available in the accessories section of the catalog.

Technical data valid for copper conductors only.

# ZS4-T3-R1 screw clamp terminal blocks

Triple deck with 3 feed-through circuits - 6 mm 0.236 in spacing

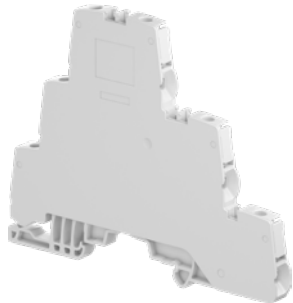
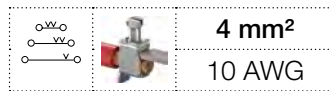

ZS4-T3-R1

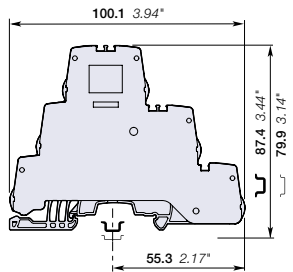

6 mm 0.236 in spacing

## Description

Unique triple deck solution combining increased connecting capacity ( up to 4 mm<sup>2</sup> with ferrule) and jumper channel available on each deck,

- Fit many applications: space constraints, multiple signals distribution, sensors distribution,
- Closed terminal block: no end section needed, optimized rigidity.

## Ordering details

Description	Color	Type	Part Number	Pkg qty	Weight (1 pce) g
Feed-through Closed block with 3 feed-through circuits	Grey <input type="checkbox"/>	ZS4-T3-R1	1SNK506213R0000	50	28.30

## Main technical data

Connecting capacity		IEC	UL - CSA	Mounting instructions	
1 conductor per clamp	Rigid: Solid/Stranded	0.2 ... 4 mm <sup>2</sup>	24 ... 10 AWG	Rail	TH 35-7.5, TH 35-15
	Flexible without ferrule	0.22 ... 4 mm <sup>2</sup>		Wire stripping length	10.5 mm 0.413 in
	Flexible with non insulated ferrule	0.22 ... 4 mm <sup>2</sup>	24 ... 12 AWG		
	Flexible with insulated ferrule	0.22 ... 4 mm <sup>2</sup>	24 ... 12 AWG		
	Gauge	A3-B3			
2 conductors per clamp	Rigid: Solid/Stranded	0.2 ... 1.5 mm <sup>2</sup>	24 ... 16 AWG	Tool	Flat screwdriver Ø 3.5 mm Ø 0.138 in
	Flexible without ferrule	0.2 ... 1.5 mm <sup>2</sup>			
	Flexible with twin ferrule	0.22 ... 1.5 mm <sup>2</sup>	24 ... 16 AWG		
Rated current / Rated cross section		32 A / 4 mm <sup>2</sup>	30 A / 10 AWG	Torque	0.6 Nm ± 0.1 5.31 lb.in ± 0.885
Rated short-time withstand current (1s)		480 A			
Rated voltage		800 V	300 V		
Impulse withstand voltage		8000 V			
Protection		IP20	NEMA 1		

The connecting capacity data for one Rigid: Solid/Stranded, or one Flexible conductor (when applicable) is a mandatory information required by IEC, UL and CSA standards (Copper conductors). All other data are provided as supplementary information only. For more details, please consult our CB, UL or CSA certificates and technical datasheet available on <http://www.TE.com>



## Accessories

Description	Color	Type	Part Number	Pkg qty	Weight (1 pce) g	
1 End stops	Dark grey <input checked="" type="checkbox"/>	BAZH1	1SNK900102R0000	20	24.00	
2 Jumper bars	Orange <input checked="" type="checkbox"/>	2 poles	JB6-2	1SNK906302R0000	50	1.30
		3 poles	JB6-3	1SNK906303R0000	50	2.10
		4 poles	JB6-4	1SNK906304R0000	50	2.90
		5 poles	JB6-5	1SNK906305R0000	50	3.60
		10 poles	JB6-10	1SNK906310R0000	20	7.40
3 Test adapters	Dark grey <input checked="" type="checkbox"/>	For test plugs DIA 2 mm 0.079 in	TP2	1SNK900203R0000	20	1.70
		For test plugs DIA 4 mm 0.157 in	TP4	1SNK900205R0000	20	2.40
4 Label holders	Dark grey <input checked="" type="checkbox"/>	LH-J	1SNK900606R0000	100	0.73	
5 Terminal block markers	White <input checked="" type="checkbox"/>	Blank marker	MG-CPM 13 41791	1SNB041791R0612	1680	0.27
		Blank card	MC512	1SNK140000R0000	22	9.00
			MC512PA	1SNK149999R0000	20	10.00
		Universal wire markers holder	Grey <input type="checkbox"/>	UMH	1SNK900611R0000	10

Complete list of accessories is indicated in the terminal block datasheet including end stops.

Some accessories such as jumper bars may modify the terminal block's ratings: Complete information available in the accessories section of the catalog.

Technical data valid for copper conductors only.

# ZS4-D-CH-UD screw clamp terminal blocks

## Component holder - 5.2 mm 0.205 in spacing

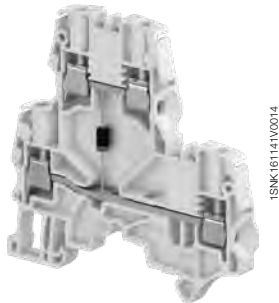

ZS4-D-CH

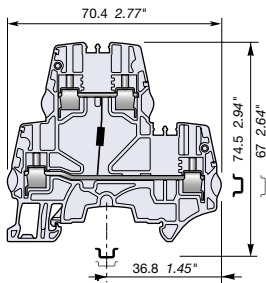

5.2 mm 0.205 in spacing

### Description

Protect your circuit with one 1N4007 diode.

### Ordering details

Description	Color	Type	Part Number	Pkg qty	Weight (1 pce) g
Component holder Cathode of the blocking diode connected to the lower circuit	Grey <input type="checkbox"/>	ZS4-D-CH-UD	1SNK505214R0000	50	15.30

### Main technical data

Connecting capacity		IEC	UL - CSA	Mounting instructions	
1 conductor per clamp	Rigid: Solid/Stranded	0.2 ... 4 mm <sup>2</sup>	24 ... 12 AWG	Rail	TH 35-7.5, TH 35-15
	Flexible without ferrule	0.22 ... 4 mm <sup>2</sup>		Wire stripping length	10 mm 0.393 in
	Flexible with non insulated ferrule	0.22 ... 4 mm <sup>2</sup>	24 ... 12 AWG	Tool	Flat screwdriver Ø 3.5 mm Ø 0.138 in
	Flexible with insulated ferrule	0.22 ... 2.5 mm <sup>2</sup>	24 ... 14 AWG		
Gauge		A3-B3		Torque	0.6 Nm ± 0.1 5.31 lb.in ± 0.885
2 conductors per clamp		0.2 ... 1.5 mm <sup>2</sup>	24 ... 16 AWG		
Rigid: Solid/Stranded		0.2 ... 1.5 mm <sup>2</sup>	24 ... 16 AWG		
Flexible without ferrule		0.2 ... 1.5 mm <sup>2</sup>	24 ... 16 AWG		
Flexible with twin ferrule		0.22 ... 1.5 mm <sup>2</sup>	24 ... 16 AWG		
Rated current / Rated cross section		29 A / 4 mm <sup>2</sup>	20 A / 12 AWG		
Rated short-time withstand current (1s)		480 A			
Short Circuit Current Rating (with specific conditions)					
Rated voltage		800 V	300 V		
Impulse withstand voltage					
Protection		IP20	NEMA 1		

The connecting capacity data for one Rigid: Solid/Stranded, or one Flexible conductor (when applicable) is a mandatory information required by IEC, UL and CSA standards (Copper conductors). All other data are provided as supplementary information only. For more details, please consult our CB, UL or CSA certificates and technical datasheet available on <http://www.TE.com>

--	--	--	--	--

### Accessories

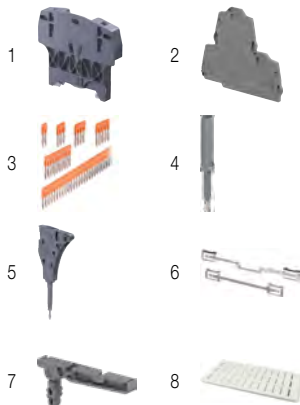

Description	Color	Type	Part Number	Pkg qty	Weight (1 pce) g	
1 End stops	Dark grey <input checked="" type="checkbox"/>	BAZH1	1SNK900102R0000	20	24.00	
2 End sections	Dark grey <input checked="" type="checkbox"/>	ES4-D2	1SNK505960R0000	20	4.10	
3 Jumper bars	Orange <input checked="" type="checkbox"/>	2 poles	JB5-2	1SNK905302R0000	50	1.30
		3 poles	JB5-3	1SNK905303R0000	50	2.00
		4 poles	JB5-4	1SNK905304R0000	50	2.70
		5 poles	JB5-5	1SNK905305R0000	50	3.50
		10 poles	JB5-10	1SNK905310R0000	30	7.10
4 Test adapters	Dark grey <input checked="" type="checkbox"/>	For test plugs DIA 2 mm 0.079 in	TP2	1SNK900203R0000	20	1.70
		For test plugs DIA 4 mm 0.157 in	TP4	1SNK900205R0000	20	2.40
5 Test connectors	Dark grey <input checked="" type="checkbox"/>	5.2 mm 0.205 in spacing	TC5	1SNK900200R0000	10	5.20
		End module, 5.2 mm 0.205 in	TC5-R1	1SNK900201R0000	10	5.20
6 Shield connectors		SHB	1SNK900602R0000	20	4.90	
7 Label holders	Dark grey <input checked="" type="checkbox"/>	LH-J	1SNK900606R0000	100	0.73	
8 Terminal block markers	White <input type="checkbox"/>	MG-CPM 13 41790	1SNB041790R0512	1960	0.23	
		MC512	1SNK140000R0000	22	9.00	
		MC512PA	1SNK149999R0000	20	10.00	
		Grey <input type="checkbox"/>	UMH	1SNK900611R0000	10	0.20

Complete list of accessories is indicated in the terminal block datasheet including end stops. Some accessories such as jumper bars may modify the terminal block's ratings: Complete information available in the accessories section of the catalog.

Technical data valid for copper conductors only.



# ZS4-D-CH-DU screw clamp terminal blocks

## Component holder - 5.2 mm 0.205 in spacing



### Description

Protect your circuit with one 1N4007 diode.

### Ordering details

Description	Color	Type	Part Number	Pkg qty	Weight (1 pce) g
Component holder Cathode of the blocking diode connected to the upper circuit	Grey <input type="checkbox"/>	ZS4-D-CH-DU	1SNK505215R0000	50	15.30

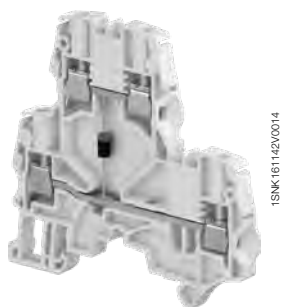

ZS4-D-CH

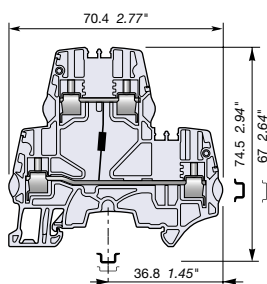

5.2 mm 0.205 in spacing

### Main technical data

Connecting capacity		IEC	UL - CSA	Mounting instructions	
1 conductor per clamp	Rigid: Solid/Stranded	0.2 ... 4 mm <sup>2</sup>	24 ... 12 AWG	Rail	TH 35-7.5, TH 35-15
	Flexible without ferrule	0.22 ... 4 mm <sup>2</sup>		Wire stripping length	10 mm 0.393 in
	Flexible with non insulated ferrule	0.22 ... 4 mm <sup>2</sup>	24 ... 12 AWG	Tool	Flat screwdriver Ø 3.5 mm Ø 0.138 in
	Flexible with insulated ferrule	0.22 ... 2.5 mm <sup>2</sup>	24 ... 14 AWG		
Gauge		A3-B3		Torque	0.6 Nm ± 0.1 5.31 lb.in ± 0.885
Rated current / Rated cross section		29 A / 4 mm <sup>2</sup>	20 A / 12 AWG		
Rated short-time withstand current (1s)		480 A			
Short Circuit Current Rating (with specific conditions)					
Rated voltage		800 V	300 V		
Impulse withstand voltage					
Protection		IP20	NEMA 1		

The connecting capacity data for one Rigid: Solid/Stranded, or one Flexible conductor (when applicable) is a mandatory information required by IEC, UL and CSA standards (Copper conductors). All other data are provided as supplementary information only. For more details, please consult our CB, UL or CSA certificates and technical datasheet available on <http://www.TE.com>

CE	RoHS	UL	CSA	EAC

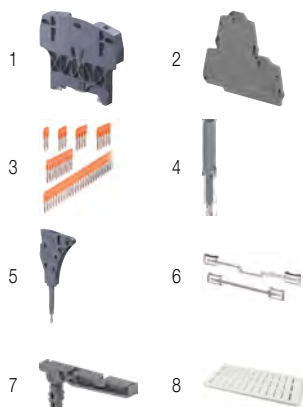

### Accessories

Description	Color	Type	Part Number	Pkg qty	Weight (1 pce) g	
1 End stops	Dark grey <input checked="" type="checkbox"/>	BAZH1	1SNK900102R0000	20	24.00	
2 End sections	Dark grey <input checked="" type="checkbox"/>	ES4-D2	1SNK505960R0000	20	4.10	
3 Jumper bars	Orange <input checked="" type="checkbox"/>	2 poles	JB5-2	1SNK905302R0000	50	1.30
		3 poles	JB5-3	1SNK905303R0000	50	2.00
		4 poles	JB5-4	1SNK905304R0000	50	2.70
		5 poles	JB5-5	1SNK905305R0000	50	3.50
		10 poles	JB5-10	1SNK905310R0000	30	7.10
		50 poles	JB5-50	1SNK905350R0000	10	36.00
4 Test adapters	Dark grey <input checked="" type="checkbox"/>	For test plugs DIA 2 mm 0.079 in	TP2	1SNK900203R0000	20	1.70
		For test plugs DIA 4 mm 0.157 in	TP4	1SNK900205R0000	20	2.40
5 Test connectors	Dark grey <input checked="" type="checkbox"/>	5.2 mm 0.205 in spacing	TC5	1SNK900200R0000	10	5.20
		End module, 5.2 mm 0.205 in	TC5-R1	1SNK900201R0000	10	5.20
6 Shield connectors		SHB	1SNK900602R0000	20	4.90	
7 Label holders	Dark grey <input checked="" type="checkbox"/>	LH-J	1SNK900606R0000	100	0.73	
8 Terminal block markers	White <input type="checkbox"/>	Blank marker	MG-CPM 13 41790	1SNB041790R0512	1960	0.23
		Blank card	MC512	1SNK140000R0000	22	9.00
			MC512PA	1SNK149999R0000	20	10.00
	Universal wire markers holder	Grey <input type="checkbox"/>	UMH	1SNK900611R0000	10	0.20

Complete list of accessories is indicated in the terminal block datasheet including end stops. Some accessories such as jumper bars may modify the terminal block's ratings: Complete information available in the accessories section of the catalog.

Technical data valid for copper conductors only.

## SNK series, terminal blocks

Screw clamp technology - Test & measurement



### Secure your measurement operations

The new ZS10-ST test & measurement terminal blocks benefit from our long experience in the energy applications and from the SNK features: performances, ergonomics, common accessories and marking.

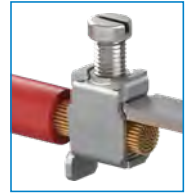

### High performances

- 10 mm<sup>2</sup> 6 AWG
- 6 mm<sup>2</sup> 10 AWG with ferrule
- 50 A (IEC) 53 A (UL)
- Worldwide certifications



## Rely on our smart design

Insulated short circuit bridges:  
SC-JB8

Insulated captive test sockets:  
AJS9  
6 colors  
compatible with standard  
DIA. 4 mm test plugs  
(IEC 60010-031)

Circuit separators: CS  
For visual separation between  
CT & PT circuits

Protecting cover kits: KCO

New ground terminal block:  
ZS10-PE-R1

Lateral jumper bar: PC8  
For CT or PT commoning

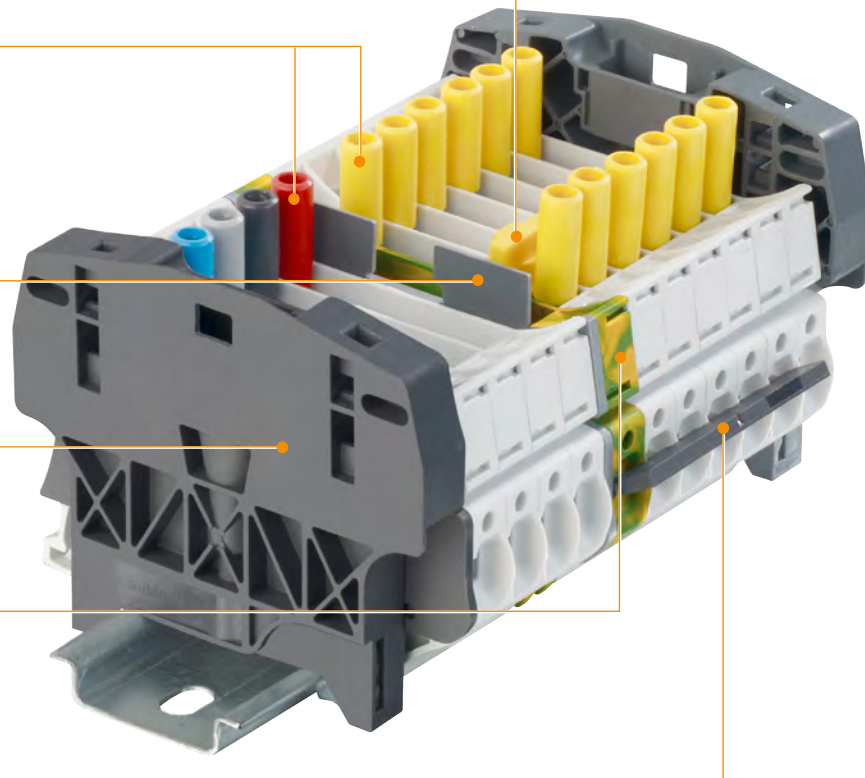

1SNK160057S0201



Assembly with protecting cover

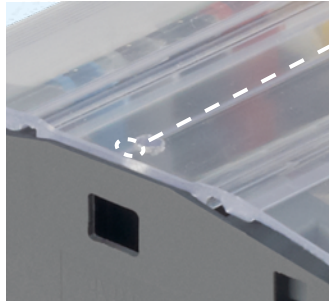

Drilling and centering guide

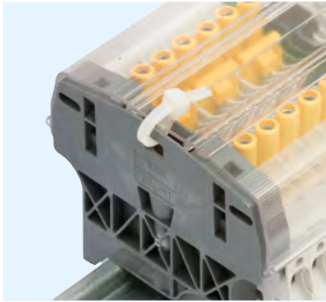

Seal with cable tie

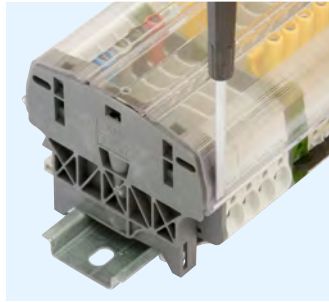

Convenient removal with screwdriver

## Guarantee access only to authorized operators

cover can be permanently sealed with a seal or cable tie.

Centering drilling guide for seal or cable tie.

The cover is specially designed to ease its mounting or removal:

- Hook shape on each side for convenient removal with screwdriver

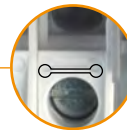
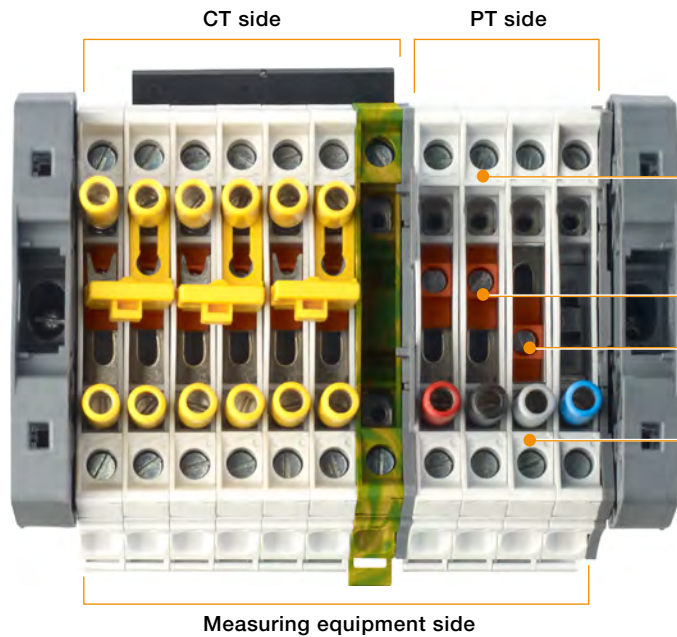

sliding link status: closed

### Disconnect sliding link status:

Open and close symbols help to visualize the sliding link position



sliding link status: opened

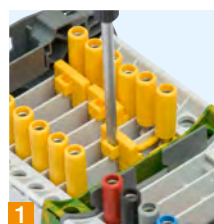

1



2



3

## Short-circuit CT circuits safely and conveniently

- 1 Fully operated by screwdriver (DIA 3.5 mm)
- 2 Short-circuited position secured thanks to AJS9 test sockets tightening
- 3 Adapted hook shape maintain the bridge on terminal block in the non connected position

# SNK series, terminal blocks

Test & measurement - Typical schematic for measuring devices

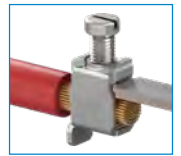

## Common point on the transformers

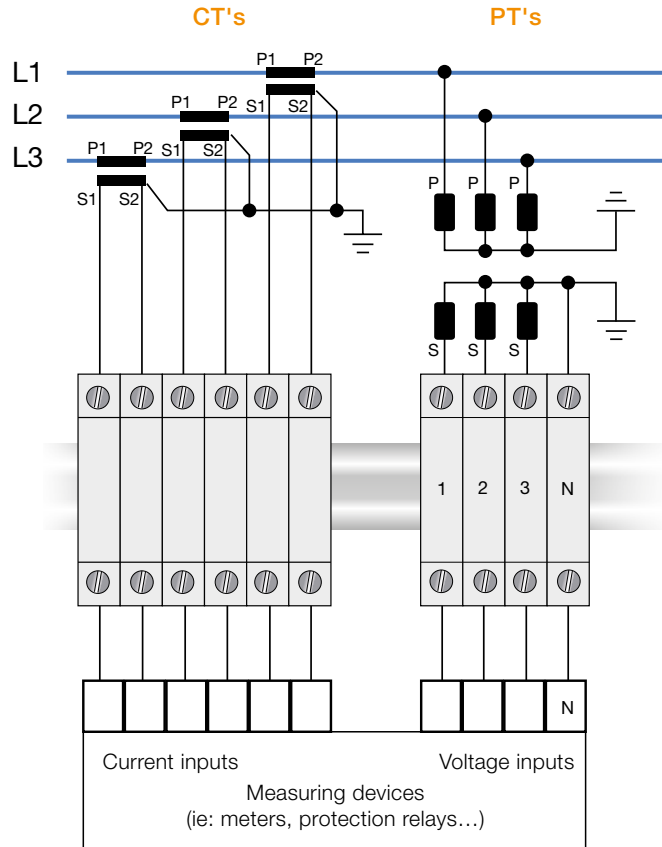

### Bill of material optimized

### Bill of material with convenient customization (test sockets, feed-through terminals...)

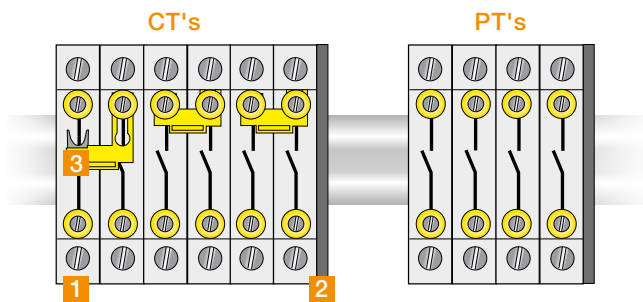

Description	Type	Order code	Qty needed	
			CT's	PT's
1 Terminal block	ZS10-ST-T4	1SNK508311R0000	6	4
2 End section	ES10-ST	1SNK508910R0000	1	1
3 Short-circuit bridges	SC-JB8-2	1SNK900652R0000	3	0

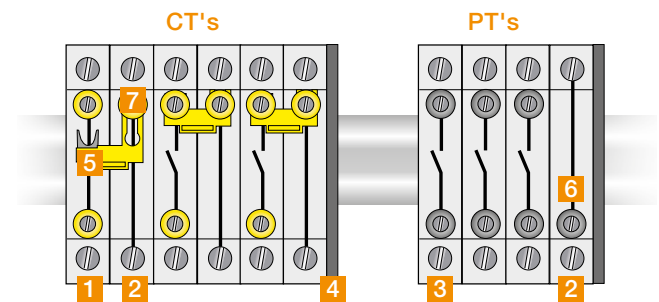

Description	Type	Order code	Qty needed	
			CT's	PT's
1 Terminal block	ZS10-ST-T4	1SNK508311R0000	3	0
2 Terminal block	ZS10-R1	1SNK508011R0000	3	1
3 Terminal block	ZS10-ST-1	1SNK508312R0000	0	3
4 End section	ES10-ST	1SNK508910R0000	1	1
5 Short-circuit bridges	SC-JB8-2	1SNK900652R0000	3	0
6 Test socket	AL4-M3	1SNA206721R0100	0	1
7 Insulated test socket	AJS9	1SNA179726R0200	3	0

1SNK160058S0201

## SNK series, terminal blocks

Test & measurement - Typical schematic for measuring devices

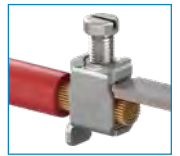

### Common point on the terminal block assembly

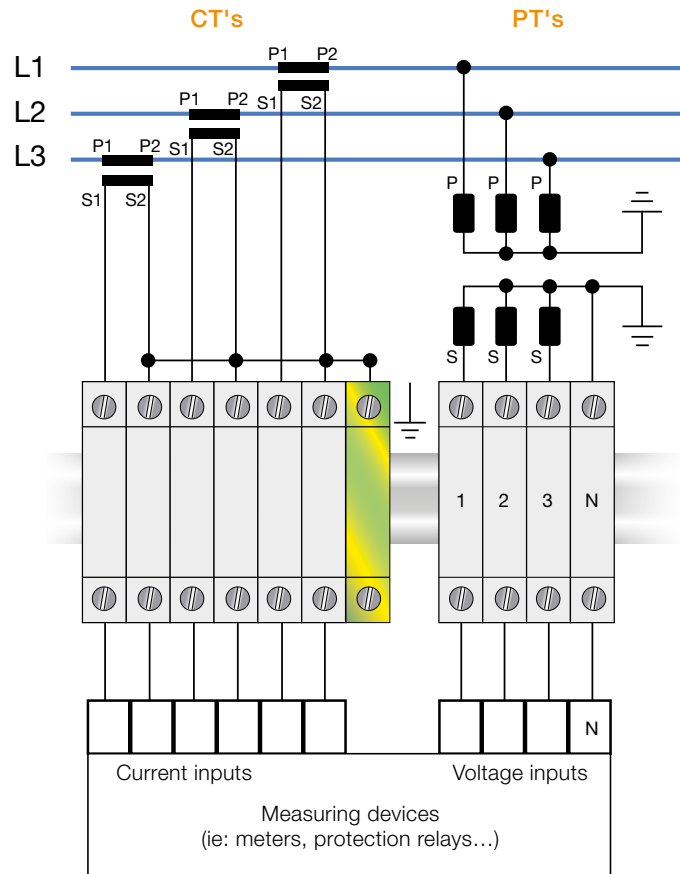

#### Bill of material optimized

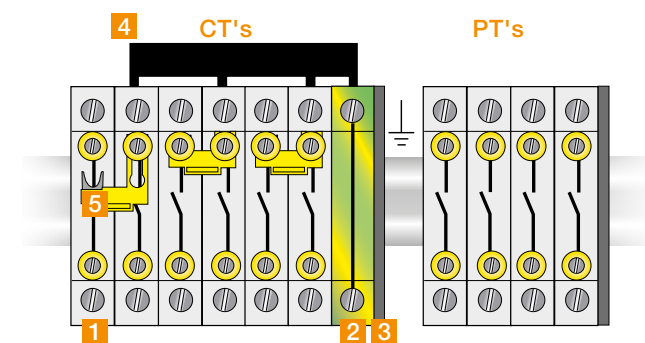

Description	Type	Order code	Qty needed	
			CT's	PT's
1 Terminal block	ZS10-ST-T4	1SNK508311R0000	6	4
2 Terminal block	ZS10-PE-R1	1SNK508151R0000	1	0
3 End section	ES10-ST	1SNK508910R0000	1	1
4 Lateral jumper bars	PC8-R1	1SNA400711R0600	1	0
5 Short-circuit bridges	SC-JB8-2	1SNK900652R0000	3	0

#### Bill of material with convenient customization (test sockets, feed-through terminals...)

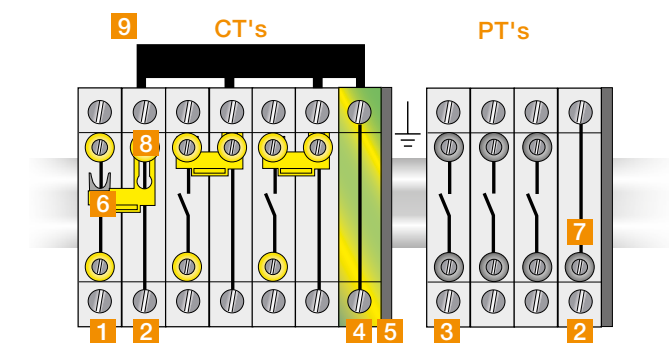

Description	Type	Order code	Qty needed	
			CT's	PT's
1 Terminal block	ZS10-ST-T4	1SNK508311R0000	3	0
2 Terminal block	ZS10-R1	1SNK508011R0000	3	1
3 Terminal block	ZS10-ST-1	1SNK508312R0000	0	3
4 Terminal block	ZS10-PE-R1	1SNK508151R0000	1	0
5 End section	ES10-ST	1SNK508910R0000	1	1
6 Short-circuit bridges	SC-JB8-2	1SNK900652R0000	3	0
7 Test socket	AL4-M3	1SNA206721R0100	0	1
8 Insulated test socket	AJS9	1SNA179726R0200	3	0
9 Lateral jumper bars	PC8-R1	1SNA400711R0600	1	0



# ZS10-ST screw clamp terminal blocks

Test disconnect with sliding link - 8 mm 0.315 in spacing



ZS10-ST

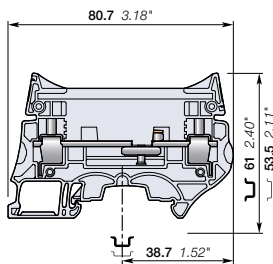

8 mm 0.315 in spacing

## Description

- Secure your disconnect operations in control circuits with the robust sliding link operated with a screwdriver,
- Customize ZS10-ST with colored test sockets in order to identify conveniently each phase of the Current Transformer or Potential Transformers secondary circuits,
- Fully compatible with the ZS10-ST-T4 accessories.

## Ordering details

Description	Color	Type	Part Number	Pkg qty	Weight (1 pce)
Disconnect	Grey	ZS10-ST	1SNK508310R0000	25	24.80

## Main technical data

Connecting capacity		IEC	UL - CSA	Mounting instructions	
1 conductor per clamp	Rigid: Solid/Stranded	0.5 ... 10 mm <sup>2</sup>	24 ... 6 AWG	Rail	TH 35-7.5, TH 35-15
	Flexible without ferrule	0.5 ... 10 mm <sup>2</sup>		Wire stripping length	13 mm 0.512 in
	Flexible with non insulated ferrule	0.5 ... 10 mm <sup>2</sup>	24 ... 8 AWG	Screw clamp Tool	Flat screwdriver Ø 3.5 mm Ø 0.138 in
	Flexible with insulated ferrule	0.5 ... 6 mm <sup>2</sup>	24 ... 10 AWG		
Gauge		A5-B5		Torque	1.3 Nm ± 0.3 11.5 lb.in ± 2.65
2 conductors per clamp	Rigid: Solid/Stranded	0.5 ... 4 mm <sup>2</sup>	20 ... 12 AWG	Disconnect device Tool	Flat screwdriver Ø 3.5 mm Ø 0.138
	Flexible without ferrule	0.5 ... 4 mm <sup>2</sup>			
	Flexible with twin ferrule	0.5 ... 4 mm <sup>2</sup>	20 ... 12 AWG	Torque	0.4 Nm ... 0.6 Nm 3.5 lb.in ... 5.3 lb.in
Rated current / Rated cross section		50 A / 10 mm <sup>2</sup>	53 A / 6 AWG		
Rated short-time withstand current (1s)		1200 A			
Rated voltage		630 V	300 V		
Impulse withstand voltage		8000 V			
Protection		IP20	NEMA 1		

The connecting capacity data for one Rigid: Solid/Stranded, or one Flexible conductor (when applicable) is a mandatory information required by IEC, UL and CSA standards (Copper conductors). All other data are provided as supplementary information only. For more details, please consult our CB, UL or CSA certificates and technical datasheet available on <http://www.TE.com>

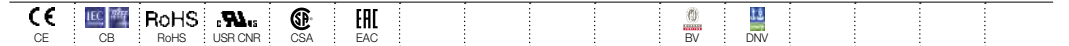

## Accessories

Description	Color	Type	Part Number	Pkg qty	Weight (1 pce)	
1 End stops	Dark grey	BAM4	1SNK900001R0000	50	14.00	
2 End sections	Dark grey	ES10-ST	1SNK508910R0000	20	3.5	
3 Jumper bars	Orange	2 poles 50 A (IEC)	JB8-2-R1	1SNK908902R0000	10	7.6
		3 poles 50 A (IEC)	JB8-3-R1	1SNK908903R0000	10	11.6
		4 poles 50 A (IEC)	JB8-4-R1	1SNK908904R0000	10	15.5
		5 poles 50 A (IEC)	JB8-5-R1	1SNK908905R0000	10	19.4
		10 poles 50 A (IEC)	JB8-10-R1	1SNK908910R0000	10	39.00
4 Circuit separators	Dark grey	CS-R3	1SNK900107R0000	20	6.40	
5 Test sockets	Yellow	AJS9	1SNA179726R0200	25	3.60	
	Black	AJS9-BK	1SNA206680R1500	25	3.60	
	Green	AJS9-GN	1SNA206681R0200	25	3.60	
	Grey	AJS9-GR	1SNA206682R0300	25	3.60	
	Blue	AJS9-BL	1SNA206683R0400	25	3.60	
	Red	AJS9-RD	1SNA206720R1400	25	3.60	
	White	AJS9-WH	1SNA206765R0000	25	3.60	
	Purple	AJS9-PR	1SNA206772R0000	25	3.60	
	Brown	AJS9-BR	1SNA206782R0000	25	3.60	
			AL4-M3	1SNA206721R0100	50	1.10
6 Terminal block markers	White	MG-CPM 13 41791	1SNB041791R0612	1680	0.27	
		MC812	1SNK160000R0000	22	10.00	
		MC812PA	1SNK169999R0000	20	14.00	
		Universal wire markers holder	UMH	1SNK900611R0000	10	0.20

Complete list of accessories is indicated in the terminal block datasheet including end stops. Some accessories such as jumper bars may modify the terminal block's ratings. Complete information available in the accessories section of the catalog.

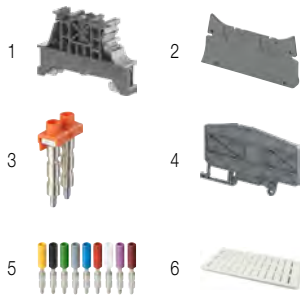

## Screw clamp terminal blocks

Description	Color	Type	Part Number	Pkg qty	Weight (1 pce)
Feed-through	Grey	ZS10-R1	1SNK508011R0000	25	20.90
Ground	Green-yellow	ZS10-PE-R1	1SNK508151R0000	25	28.40

Technical data valid for copper conductors only.

# ZS10-ST-1 screw clamp terminal blocks

Test disconnect with sliding link for Potential Transformer circuits - 8 mm 0.315 in spacing

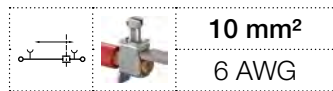

ZS10-ST-1

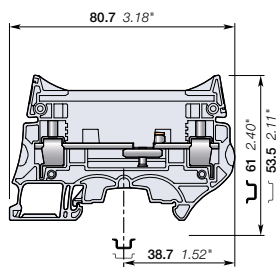

8 mm 0.315 in spacing

## Description

Test terminal blocks especially designed for Potential Transformers circuits:

- low profile voltage measurement thanks to the two compact built-in test sockets compatible with DIA 4 mm 0.157 in test plugs,
- Installed with our aligned feed-through and ground terminal blocks, you benefit of a complete and compact solution for your PT circuits.

## Ordering details

Description	Color	Type	Part Number	Pkg qty	Weight (1 pce) g
Disconnect With 2 test sockets DIA 4 mm 0.157 in	Grey <input type="checkbox"/>	ZS10-ST-1	1SNK508312R0000	25	27.00

## Main technical data

Connecting capacity	IEC	UL - CSA	Mounting instructions		
1 conductor per clamp	Rigid: Solid/Stranded	0.5 ... 10 mm <sup>2</sup>	24 ... 6 AWG	Rail	TH 35-7.5, TH 35-15
	Flexible without ferrule	0.5 ... 10 mm <sup>2</sup>	24 ... 6 AWG	Wire stripping length	13 mm 0.512 in
	Flexible with non insulated ferrule	0.5 ... 10 mm <sup>2</sup>	24 ... 8 AWG	Screw clamp Tool	Flat screwdriver Ø 3.5 mm Ø 0.138 in
	Flexible with insulated ferrule	0.5 ... 6 mm <sup>2</sup>	24 ... 10 AWG		
Gauge		A5-B5	Torque	1.3 Nm ± 0.3	11.5 lb.in ± 2.65
2 conductors per clamp	Rigid: Solid/Stranded	0.5 ... 4 mm <sup>2</sup>	20 ... 12 AWG	Disconnect device Tool	Flat screwdriver Ø 3.5 mm Ø 0.138
	Flexible without ferrule	0.5 ... 4 mm <sup>2</sup>	20 ... 12 AWG		
Flexible with twin ferrule		0.5 ... 4 mm <sup>2</sup>	20 ... 12 AWG	Torque	0.4 Nm ... 0.6 Nm 3.5 lb.in ... 5.3 lb.in
Rated current / Rated cross section		50 A / 10 mm <sup>2</sup>	53 A / 6 AWG		
Rated short-time withstand current (1s)		1200 A			
Rated voltage		630 V	300 V		
Impulse withstand voltage		8000 V			
Protection		IP10	NEMA 1		

The connecting capacity data for one Rigid: Solid/Stranded, or one Flexible conductor (when applicable) is a mandatory information required by IEC, UL and CSA standards (Copper conductors). All other data are provided as supplementary information only. For more details, please consult our CB, UL or CSA certificates and technical datasheet available on <http://www.TE.com>

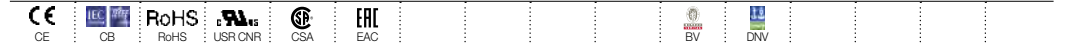

## Accessories

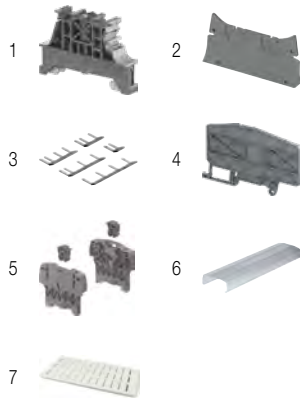

Description	Color	Type	Part Number	Pkg qty	Weight (1 pce) g
1 End stops 10 mm 0.394 in	Dark grey <input type="checkbox"/>	BAM4	1SNK900001R0000	50	14.00
2 End sections 2 mm 0.079 in	Dark grey <input type="checkbox"/>	ES10-ST	1SNK508910R0000	20	3.5
3 Lateral jumper bars 10 poles	Black <input type="checkbox"/>	PC8-10	1SNA163313R2400	10	14.00
		PC8-R1	1SNA400711R0600	10	6.60
		PC8-R2	1SNA400712R0700	10	7.80
		PC8-R3	1SNA400713R0000	10	9.00
		PC8-R4	1SNA400724R0300	10	4.50
		PC8-R5	1SNA400842R0000	10	6.60
		PC8-R6	1SNA400843R0000	10	6.60
		PC8-R7	1SNA400849R0000	10	6.60
PC8-R8	1SNA400850R0000	10	7.80		
4 Circuit separators 3 mm 0.118 in	Dark grey <input type="checkbox"/>	CS-R3	1SNK900107R0000	20	6.40
5 Protecting cover kits	Dark grey <input type="checkbox"/>	KCO	1SNK900624R0000	1	47.80
6 Protecting covers 1 m 39.4 in length	Transparent <input checked="" type="checkbox"/>	CO	1SNK900604R0000	1	300.00
7 Terminal block markers	White <input type="checkbox"/>	MG-CPM 13 41791	1SNB041791R0612	1680	0.27
		MC812	1SNK160000R0000	22	10.00
		MC812PA	1SNK169999R0000	20	14.00
		Universal wire markers holder	Grey <input type="checkbox"/>	UMH	1SNK900611R0000

Complete list of accessories is indicated in the terminal block datasheet including end stops.

Some accessories such as jumper bars may modify the terminal block's ratings: Complete information available in the accessories section of the catalog.

## Screw clamp terminal blocks

Description	Color	Type	Part Number	Pkg qty	Weight (1 pce) g
Feed-through Profile aligned with ZS10-ST...	Grey <input type="checkbox"/>	ZS10-R1	1SNK508011R0000	25	20.90
Ground Profile aligned with ZS10-ST...	Green-yellow <input type="checkbox"/>	ZS10-PE-R1	1SNK508151R0000	25	28.40



ZS10-R1

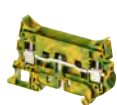

ZS10-PE-R1

Technical data valid for copper conductors only.

# ZS10-ST-T4 screw clamp terminal blocks

Test disconnect with sliding link for Current Transformer circuits - 8 mm 0.315 in spacing



ZS10-ST-T4

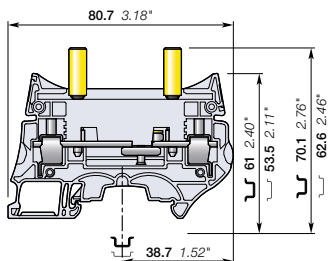

8 mm 0.315 in spacing

## Description

Test terminal blocks especially designed for Current Transformers circuits:

- easy and safe current measurement thanks to the two insulated built-in test sockets compatible with IP20 DIA 4 mm 0.157 in test plugs (per IEC60101-031),
- convenient short-circuit operations with the SC-JB insulated sliding bridges.

## Ordering details

Description	Color	Type	Part Number	Pkg qty	Weight (1 pce) g
Disconnect With two yellow test sockets DIA 4 mm 0.157 in	Grey <input type="checkbox"/>	ZS10-ST-T4	1SNK508311R0000	25	31.90

## Main technical data

Connecting capacity		IEC	UL - CSA	Mounting instructions	
1 conductor per clamp	Rigid: Solid/Stranded	0.5 ... 10 mm <sup>2</sup>	24 ... 6 AWG	Rail	TH 35-7.5, TH 35-15
	Flexible without ferrule	0.5 ... 10 mm <sup>2</sup>	24 ... 8 AWG	Wire stripping length	13 mm 0.512 in
	Flexible with non insulated ferrule	0.5 ... 10 mm <sup>2</sup>	24 ... 8 AWG	Screw clamp Tool	Flat screwdriver Ø 3.5 mm 0.138 in
	Flexible with insulated ferrule	0.5 ... 6 mm <sup>2</sup>	24 ... 10 AWG		
Gauge		A5-B5		Torque	1.3 Nm ± 0.3 11.5 lb.in ± 2.65
2 conductors per clamp	Rigid: Solid/Stranded	0.5 ... 4 mm <sup>2</sup>	20 ... 12 AWG	Disconnect device Tool	Flat screwdriver Ø 3.5 mm 0.138
	Flexible without ferrule	0.5 ... 4 mm <sup>2</sup>	20 ... 12 AWG		
	Flexible with twin ferrule	0.5 ... 4 mm <sup>2</sup>	20 ... 12 AWG		
Rated current / Rated cross section		50 A / 10 mm <sup>2</sup>	53 A / 6 AWG	Torque	0.4 Nm ... 0.6 Nm 3.5 lb.in ... 5.3 lb.in
Rated short-time withstand current (1s)		1200 A		Test socket Tool	Flat screwdriver Ø 3.5 mm 0.138
Rated voltage		630 V	300 V		
Impulse withstand voltage		8000 V		Torque	0.4 Nm ... 0.6 Nm 3.5 lb.in ... 5.3 lb.in
Protection		IP20	NEMA 1	Torque	0.4 Nm ... 0.6 Nm 3.5 lb.in ... 5.3 lb.in

The connecting capacity data for one Rigid: Solid/Stranded, or one Flexible conductor (when applicable) is a mandatory information required by IEC, UL and CSA standards (Copper conductors). All other data are provided as supplementary information only. For more details, please consult our CB, UL or CSA certificates and technical datasheet available on <http://www.TE.com>

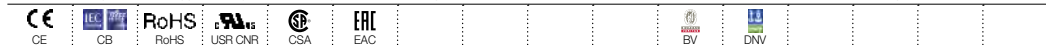

## Accessories

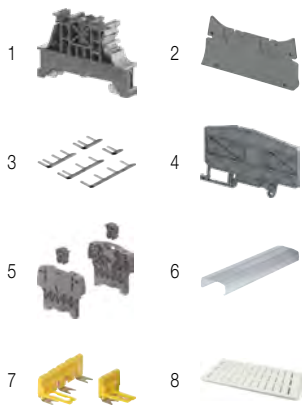

Description	Color	Type	Part Number	Pkg qty	Weight (1 pce) g	
1 End stops 10 mm 0.394 in	Dark grey <input type="checkbox"/>	BAM4	1SNK900001R0000	50	14.00	
2 End sections 2 mm 0.079 in	Dark grey <input type="checkbox"/>	ES10-ST	1SNK508910R0000	20	3.5	
3 Lateral jumper bars	Black <input type="checkbox"/>	10 poles	PC8-10	1SNA163313R2400	10	14.00
		4/6 poles	PC8-R1	1SNA400711R0600	10	6.60
		4/8 poles	PC8-R2	1SNA400712R0700	10	7.80
		4/10 poles	PC8-R3	1SNA400713R0000	10	9.00
		3/4 poles	PC8-R4	1SNA400724R0300	10	4.50
		4/7 poles	PC8-R5	1SNA400842R0000	10	6.60
		2/3 poles	PC8-R6	1SNA400843R0000	10	6.60
		4/6 poles	PC8-R7	1SNA400849R0000	10	6.60
4/8 poles	PC8-R8	1SNA400850R0000	10	7.80		
4 Circuit separators 3 mm 0.118 in	Dark grey <input type="checkbox"/>	CS-R3	1SNK900107R0000	20	6.40	
5 Protecting cover kits	Dark grey <input type="checkbox"/>	KCO	1SNK900624R0000	1	47.80	
6 Protecting covers 1 m 39.4 in length	Transparent <input type="checkbox"/>	CO	1SNK900604R0000	1	300.00	
7 Short circuit bridges	Yellow <input type="checkbox"/>	2 poles	SC-JB8-2	1SNK900652R0000	25	2.00
		3 poles	SC-JB8-3	1SNK900653R0000	25	3.4
		4 poles	SC-JB8-4	1SNK900654R0000	25	4.7
8 Terminal block markers	White <input type="checkbox"/>	Blank marker	MG-CPM 13 41791	1SNB041791R0612	1680	0.27
		Blank card	MC812	1SNK160000R0000	22	10.00
			MC812PA	1SNK169999R0000	20	14.00
		Universal wire markers holder	Grey <input type="checkbox"/>	UMH	1SNK900611R0000	10

Complete list of accessories is indicated in the terminal block datasheet including end stops.

Some accessories such as jumper bars may modify the terminal block's ratings: Complete information available in the accessories section of the catalog.

## Screw clamp terminal blocks

Description	Color	Type	Part Number	Pkg qty	Weight (1 pce) g
Feed-through Profile aligned with ZS10-ST...	Grey <input type="checkbox"/>	ZS10-R1	1SNK508011R0000	25	20.90
Ground Profile aligned with ZS10-ST...	Green-yellow <input type="checkbox"/>	ZS10-PE-R1	1SNK508151R0000	25	28.40



ZS10-R1



ZS10-PE-R1

Technical data valid for copper conductors only.

# ZS10-R1 screw clamp terminal blocks

Feed-through - 8 mm 0.315 in spacing

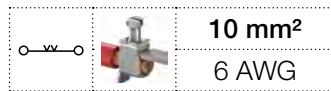

ZS10-R1

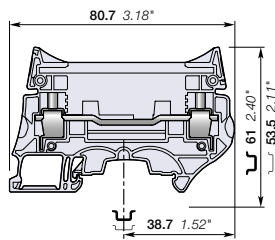

8 mm 0.315 in spacing

## Description

- With the same profile as the ZS10-ST..., the feed-through ZS10-R1 allows you to fully implement the electrical drawing of your CT or PT circuits,
- Fully compatible with the ZS10-ST... accessories.

## Ordering details

Description	Color	Type	Part Number	Pkg qty	Weight (1 pce) g
Feed-through Profile aligned with ZS10-ST..	Grey <input type="checkbox"/>	ZS10-R1	1SNK508011R0000	25	20.90

## Main technical data

Connecting capacity		IEC	UL - CSA	Mounting instructions	
1 conductor per clamp	Rigid: Solid/Stranded	0.5 ... 10 mm <sup>2</sup>	24 ... 6 AWG	Rail	TH 35-7.5, TH 35-15
	Flexible without ferrule	0.5 ... 10 mm <sup>2</sup>		Wire stripping length	13 mm 0.512 in
	Flexible with non insulated ferrule	0.5 ... 10 mm <sup>2</sup>	24 ... 8 AWG	Tool	Flat screwdriver Ø 3.5 mm Ø 0.138 in
	Flexible with insulated ferrule	0.5 ... 6 mm <sup>2</sup>	24 ... 10 AWG		
Gauge		A5-B5		Torque	1.3 Nm ± 0.3 11.5 lb.in ± 2.65
2 conductors per clamp	Rigid: Solid/Stranded	0.5 ... 4 mm <sup>2</sup>	20 ... 12 AWG		
	Flexible without ferrule	0.5 ... 4 mm <sup>2</sup>	20 ... 12 AWG		
	Flexible with twin ferrule	0.5 ... 4 mm <sup>2</sup>	20 ... 12 AWG		
Rated current / Rated cross section		57 A / 10 mm <sup>2</sup>	62 A / 6 AWG		
Rated short-time withstand current (1s)		1200 A			
Short Circuit Current Rating (with specific conditions)					
Rated voltage		630 V	300 V		
Impulse withstand voltage		8000 V			
Protection		IP20	NEMA 1		

The connecting capacity data for one Rigid: Solid/Stranded, or one Flexible conductor (when applicable) is a mandatory information required by IEC, UL and CSA standards (Copper conductors). All other data are provided as supplementary information only. For more details, please consult our CB, UL or CSA certificates and technical datasheet available on <http://www.TE.com>

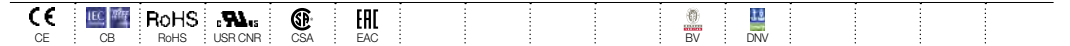

## Accessories

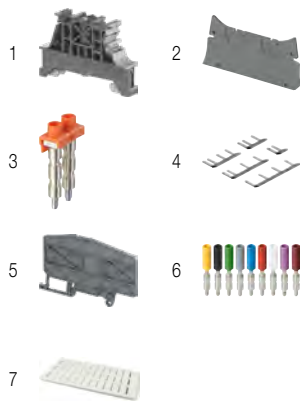

Description	Color	Type	Part Number	Pkg qty	Weight (1 pce) g	
1 End stops 10 mm 0.394 in	Dark grey <input type="checkbox"/>	BAM4	1SNK900001R0000	50	14.00	
2 End sections 2 mm 0.079 in	Dark grey <input type="checkbox"/>	ES10-ST	1SNK508910R0000	20	3.5	
3 Jumper bars	Orange <input type="checkbox"/>	2 poles 50 A (IEC)	JB8-2-R1	1SNK908902R0000	10	7.6
		3 poles 50 A (IEC)	JB8-3-R1	1SNK908903R0000	10	11.6
		4 poles 50 A (IEC)	JB8-4-R1	1SNK908904R0000	10	15.5
		5 poles 50 A (IEC)	JB8-5-R1	1SNK908905R0000	10	19.4
		10 poles 50 A (IEC)	JB8-10-R1	1SNK908910R0000	10	39.00
4 Lateral jumper bars	Black <input type="checkbox"/>	4/7 poles	PC8-R5	1SNA400842R0000	10	6.60
		2/3 poles	PC8-R6	1SNA400843R0000	10	6.60
		4/6 poles	PC8-R7	1SNA400849R0000	10	6.60
		4/8 poles	PC8-R8	1SNA400850R0000	10	7.80
5 Circuit separators 3 mm 0.118 in	Dark grey <input type="checkbox"/>	CS-R3	1SNK900107R0000	20	6.40	
6 Test sockets Test sockets DIA 4 mm 0.157 in	Yellow <input type="checkbox"/>	AJS9	1SNA179726R0200	25	3.60	
7 Terminal block markers	White <input type="checkbox"/>	Blank marker	MG-CPM 13 41791	1SNB041791R0612	1680	0.27
		Blank card	MC812	1SNK160000R0000	22	10.00
		Blank card	MC812PA	1SNK169999R0000	20	14.00
Universal wire markers holder	Grey <input type="checkbox"/>	UMH	1SNK900611R0000	10	0.20	

Complete list of accessories is indicated in the terminal block datasheet including end stops. Some accessories such as jumper bars may modify the terminal block's ratings: Complete information available in the accessories section of the catalog.

Technical data valid for copper conductors only.





# ZS10-PE-R1 screw clamp terminal blocks

Ground - 8 mm 0.315 in spacing

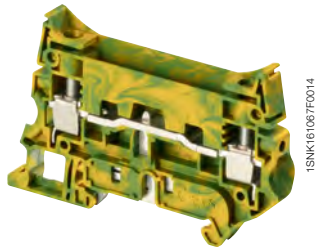

ZS10-PE-R1

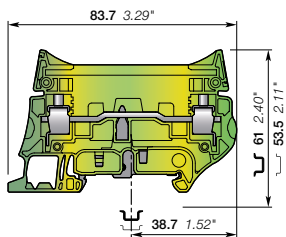

8 mm 0.315 in spacing

## Description

- With the same profile as the ZS10-ST..., the ground ZS10-PE-R1 allows you to fully implement the electrical drawing of your CT or PT circuits,
- Fully compatible with the ZS10-ST... accessories,
- Short-circuit performances above the requirements of IEC 60947-7-2 terminal block standard,
- Secured snap on or remove from the rail.

## Ordering details

Description	Color	Type	Part Number	Pkg qty	Weight (1 pce) g
Ground Profile aligned with ZS10-ST...	Green-yellow	ZS10-PE-R1	1SNK508151R0000	25	28.40

## Main technical data

Connecting capacity	IEC	UL - CSA	Mounting instructions
<b>1 conductor per clamp</b> Rigid: Solid/Stranded Flexible without ferrule Flexible with non insulated ferrule Flexible with insulated ferrule Gauge	0.5 ... 10 mm <sup>2</sup>	24 ... 6 AWG	<b>Rail</b> TH 35-7.5, TH 35-15 
	0.5 ... 10 mm <sup>2</sup>	24 ... 8 AWG	<b>Wire stripping length</b> 13 mm 0.512 in 
	0.5 ... 10 mm <sup>2</sup>	24 ... 10 AWG	<b>Tool</b> Flat screwdriver Ø 3.5 mm Ø 0.138 in 
	0.5 ... 6 mm <sup>2</sup>	24 ... 10 AWG	
	A5-B5		
Rated cross section	10 mm <sup>2</sup>	6 AWG	<b>Torque</b> 1.3 Nm ± 0.3 11.5 lb.in ± 2.65 
Rated short-time withstand current (1s)	1200 A	1596 A	
Protection	IP20	NEMA 1	

The connecting capacity data for one Rigid: Solid/Stranded, or one Flexible conductor (when applicable) is a mandatory information required by IEC, UL and CSA standards (Copper conductors). All other data are provided as supplementary information only. For more details, please consult our CB, UL or CSA certificates and technical datasheet available on <http://www.TE.com>

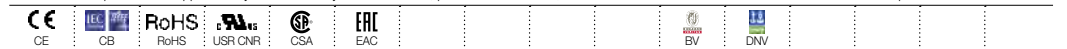

## Accessories

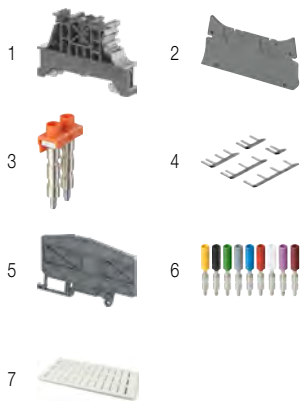

Description	Color	Type	Part Number	Pkg qty	Weight (1 pce) g	
1 End stops 10 mm 0.394 in	Dark grey	BAM4	1SNK900001R0000	50	14.00	
2 End sections 2 mm 0.079 in	Dark grey	ES10-ST	1SNK508910R0000	20	3.5	
3 Jumper bars	Orange	2 poles 50 A (IEC)	JB8-2-R1	1SNK908902R0000	10	7.6
		3 poles 50 A (IEC)	JB8-3-R1	1SNK908903R0000	10	11.6
		4 poles 50 A (IEC)	JB8-4-R1	1SNK908904R0000	10	15.5
		5 poles 50 A (IEC)	JB8-5-R1	1SNK908905R0000	10	19.4
		10 poles 50 A (IEC)	JB8-10-R1	1SNK908910R0000	10	39.00
4 Lateral jumper bars	Black	4/7 poles	PC8-R5	1SNA400842R0000	10	6.60
		2/3 poles	PC8-R6	1SNA400843R0000	10	6.60
		4/6 poles	PC8-R7	1SNA400849R0000	10	6.60
		4/8 poles	PC8-R8	1SNA400850R0000	10	7.80
5 Circuit separators 3 mm 0.118 in	Dark grey	CS-R3	1SNK900107R0000	20	6.40	
6 Test sockets Test sockets DIA 4 mm 0.157 in	Yellow	AJS9	1SNA179726R0200	25	3.60	
7 Terminal block markers	White	Blank marker	MG-CPM 13 41791	1SNB041791R0612	1680	0.27
		Blank card	MC812	1SNK160000R0000	22	10.00
		Blank card	MC812PA	1SNK169999R0000	20	14.00
Universal wire markers holder	Grey	UMH	1SNK900611R0000	10	0.20	

Complete list of accessories is indicated in the terminal block datasheet including end stops. Some accessories such as jumper bars may modify the terminal block's ratings: Complete information available in the accessories section of the catalog.

Technical data valid for copper conductors only.





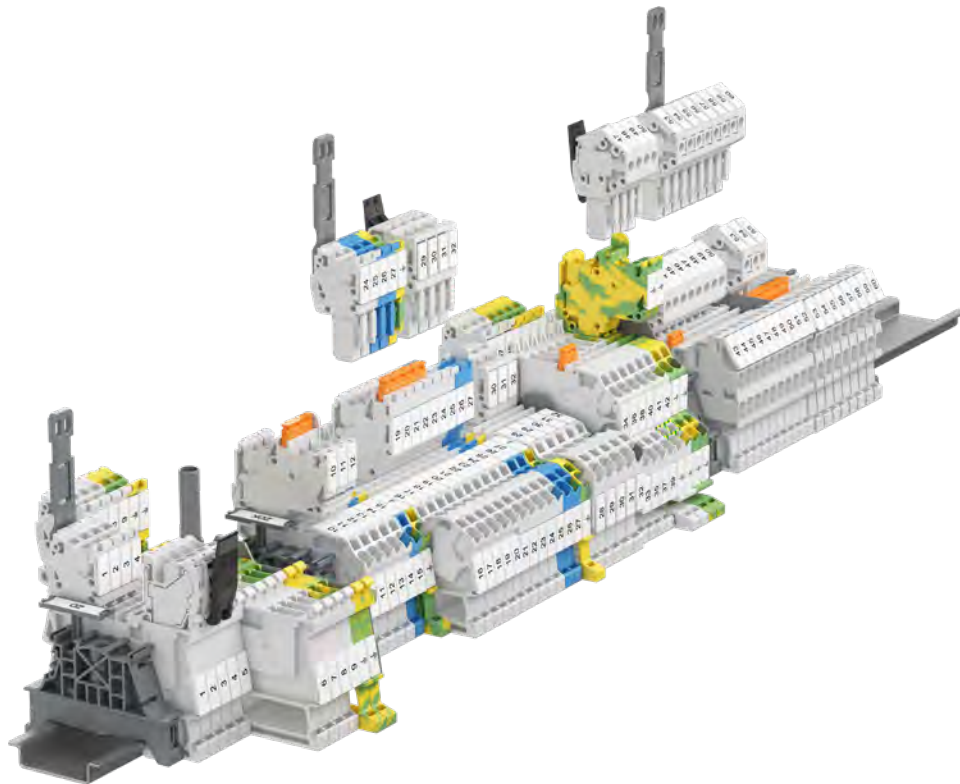

## SNK series, terminal blocks

### Pluggable technology

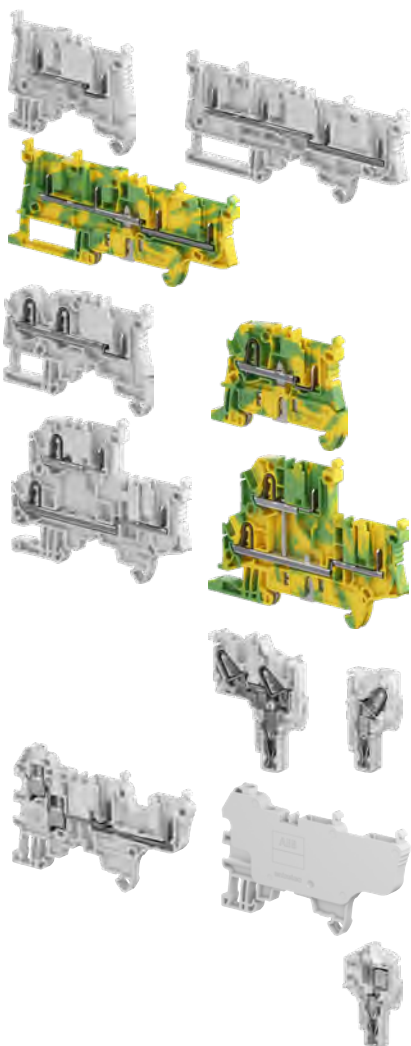

Technologies presentation	162
Overview	168

#### PI-Spring Pluggable

##### Pluggable Pluggable

2.5 mm <sup>2</sup> / 12 AWG	Feed-through	ZD2.5-11	172
		ZD2.5-22	173
	Ground	ZD2.5-22-PE	174

##### PI-Spring Pluggable

2.5 mm <sup>2</sup> / 12 AWG	Feed-through	ZDK2.5-11	175
		ZDK2.5-21	176
		ZDK2.5-22	177
4 mm <sup>2</sup> / 10 AWG	Feed-through	ZDK4-22	178
2.5 mm <sup>2</sup> / 12 AWG	Ground	ZDK2.5-11-PE	179
		ZDK2.5-22-PE	180
	Double deck	ZDK2.5-D2	181
		ZDK2.5-D1	182
		ZDK2.5-D2-PE	183
		ZDK2.5-D1-PE	184

PI-Spring female plugs	CDK2.5	185
	CDK2.5-J	186
	CDK2.5-2P-J	187
	CDK4	188

#### Screw clamp Pluggable

4 mm <sup>2</sup> / 10 AWG	Feed-through	ZDS4-22	190
		ZDS4-22-R1	192
Screw clamp female plugs	CDS4	191	
	CDS4-R1	193	

# Pluggable technology - SNK series, terminal blocks

## Features and benefits

The SNK series pluggable terminal blocks combine the benefits of our smart connections with the flexibility of the pluggable function.

### PI-Spring Pluggable



PI-Spring Pluggable



Pluggable Pluggable

### Screw clamp Pluggable



## Speed up your projects

### Modularity brings assembly flexibility

Pluggable technology brings modularity into the electrical installation allowing the combination of sub-assemblies and prewired harnesses that facilitate and considerably accelerate assembly test and factory commissioning.

### Better project identification

- Circuit identification is improved thanks to the 20% larger marking area
- Pre-mark by hand or with label on our flat marking surface and start immediately the wiring, before the final markers mounting
- Spare markers re-printing in case of modifications.



Clear circuit identification

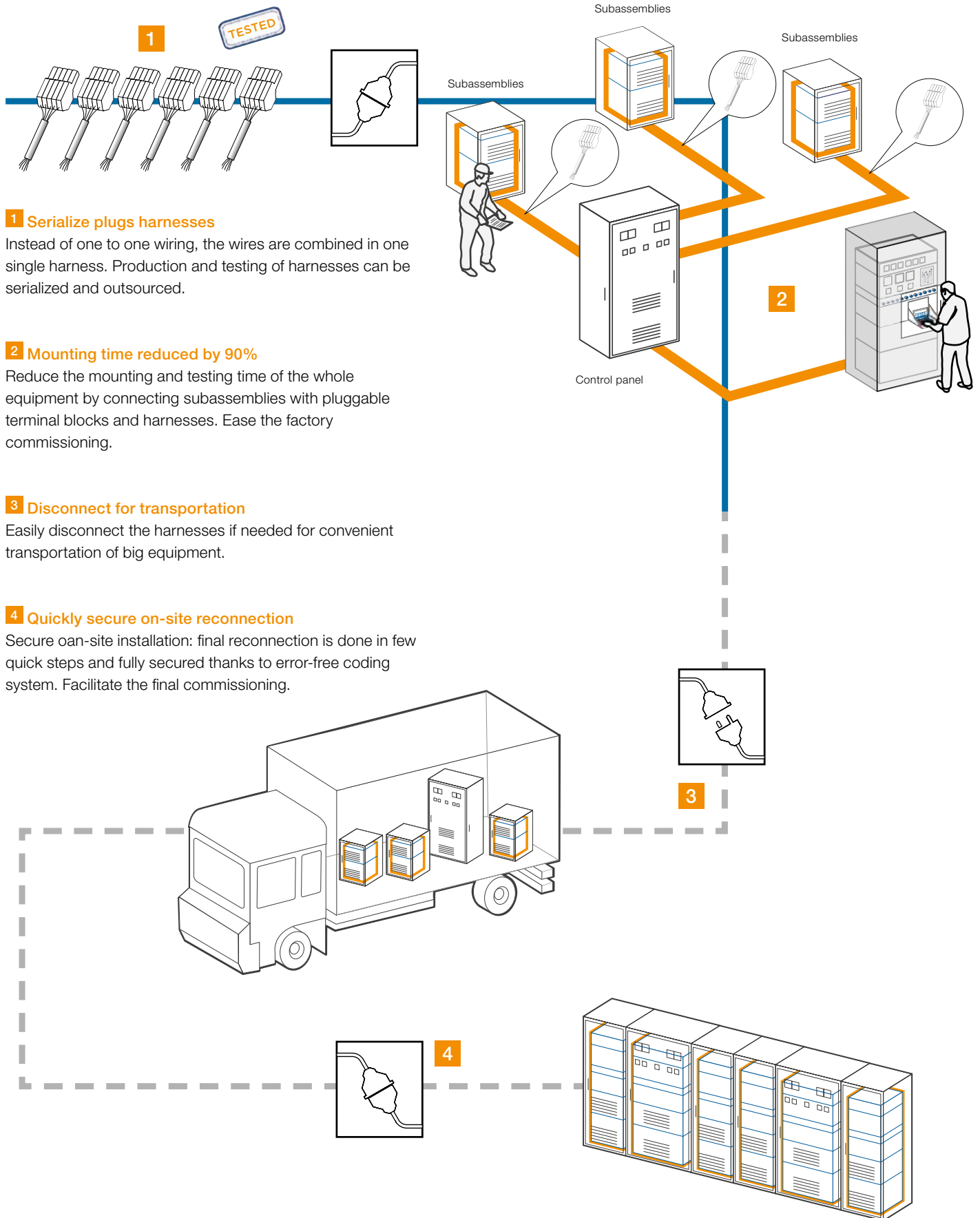

**1 Serialize plugs harnesses**

Instead of one to one wiring, the wires are combined in one single harness. Production and testing of harnesses can be serialized and outsourced.

**2 Mounting time reduced by 90%**

Reduce the mounting and testing time of the whole equipment by connecting subassemblies with pluggable terminal blocks and harnesses. Ease the factory commissioning.

**3 Disconnect for transportation**

Easily disconnect the harnesses if needed for convenient transportation of big equipment.

**4 Quickly secure on-site reconnection**

Secure on-site installation: final reconnection is done in few quick steps and fully secured thanks to error-free coding system. Facilitate the final commissioning.



# Pluggable technology - SNK series, terminal blocks

## Features and benefits

### Easy to install

#### Smart design facilitating assembly process

Mounting, wiring, testing... made easy.

Create your own assemblies without tooling:

- Easily snap together multiple plugs
- Eliminate stock of pre-configured plugs.

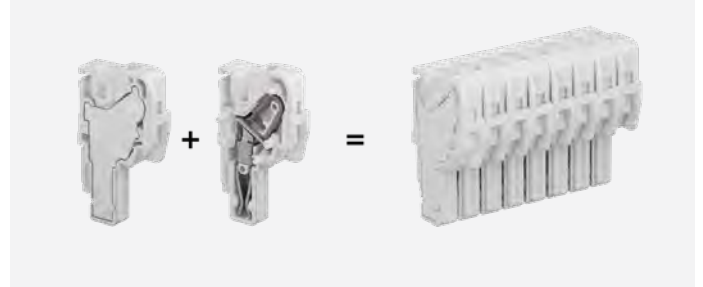

Only two plug variants are required to compose harnesses up to 15 poles

Some plugs feature a jumper channel and/or 2 connections that ease the signal distribution or wiring daisy chaining of subassemblies.

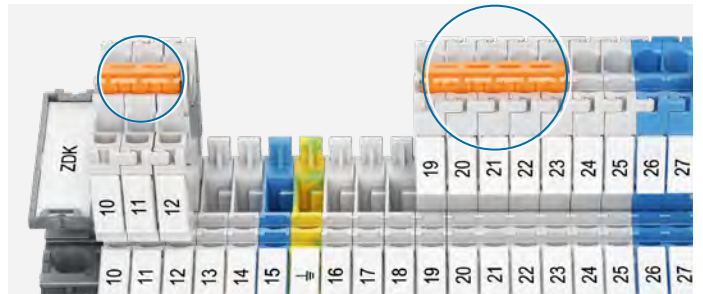

Easy signal distribution on plugs

#### Safety and protection

Eliminate connection errors with coding pegs:

- Simply insert the pegs to create a coding sequence.

Secure your wiring against accidental tearing:

- Automatic locking function
- Lock safely 2 to 8 plugs with only one locking device
- Cable clamp secures the wires onto the plug when pulling the plug assembly.

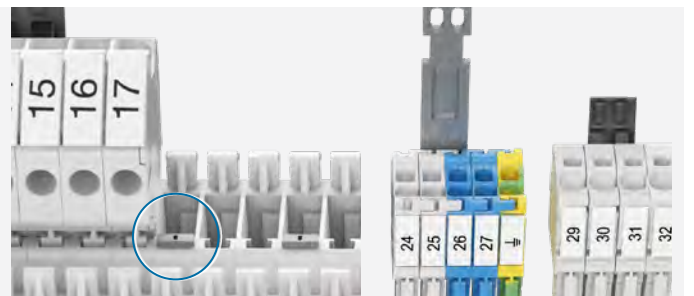

Convenient coding pegs

Cable clamp & locking device

## SNK series, terminal blocks

### Features and benefits

#### Faster accessories mounting

Save up to 70% mounting time thanks to:

- Screwless jumpers, component plugs, test devices, end stops and snap-in ground terminal blocks.

Closed jumper location allows great stiffness of the terminal block, avoid deflection while tightening and optimal jumper guiding.

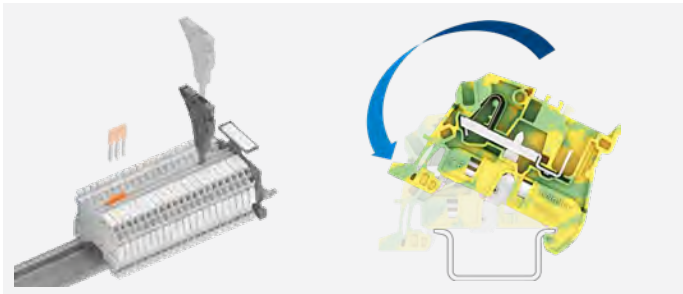

Screwless accessories

Snap-in ground terminal blocks

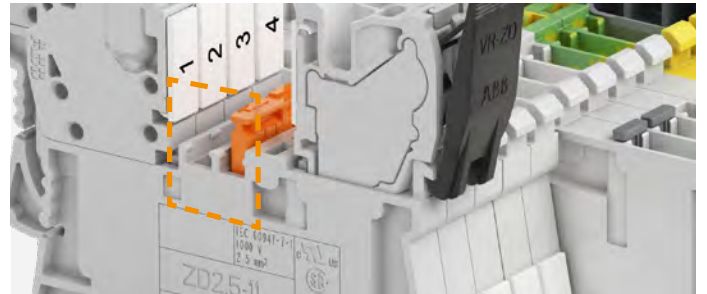

Closed jumper location for stiffness

#### Smart accessories

Flexible test solutions from individual insulated test adapter to test connectors for complete assemblies testing.

- Direct plug-in into jumpers channels
- 5, 6, 8 mm spacing, mixing various spacing is possible
- 1000 V rating.

#### Smart plug-in jumpers

Pre-cut poles removable by hand: clean cut.

Insulated up to 1000 V (avoid use of separators).

Predefined shapes in molding to easily identify connected poles with a pen.



Plug-in individual test adapter

Plug-in test connector

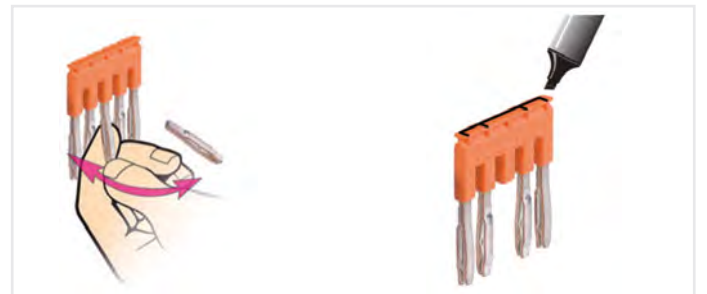

Pre-cut poles easy removable by hand

Predefined shape to identify connected poles

# Pluggable technology - SNK series, terminal blocks

## Features and benefits

### Optimized logistics

#### Reduce your accessories inventory by up to 50%

SNK PI-Spring, screw and pluggable ranges share the same accessories.

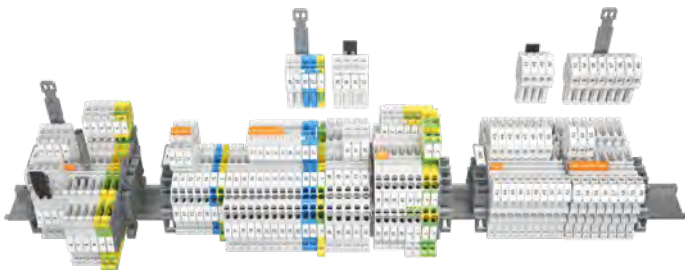

Shared accessories for SNK PI-Spring, screw and pluggable ranges

#### Facilitate maintenance operations

Terminal blocks can be individually removed from a terminal assembly equipped with markers: TE Connectivity markers become independent after strip mounting. The markers remain on terminal in any situation.

Markers are interchangeable: the smaller marker can fit any bigger block.



Maintenance operations facilitated

#### Reliable in harsh conditions

Qualified for worldwide markets, applications and for severe environments: vibration, shock, corrosion...





## SNK series, terminal blocks

Pluggable technology - Range overview from 2.5 to 4 mm<sup>2</sup> - 12 to 10 AWG

### Pluggable Pluggable

**2**

Connections  
Single deck  
Feed-through

**4**

Connections  
Single deck  
Feed-through  
Ground

### PI-Spring Pluggable

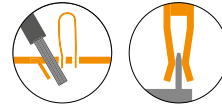

### PI-Spring Pluggable

**2**

Connections  
Single deck  
Feed-through  
Ground

**3**

Connections  
Single deck  
Feed-through

**4**

Connections  
Single deck  
Feed-through  
Ground

Plugs

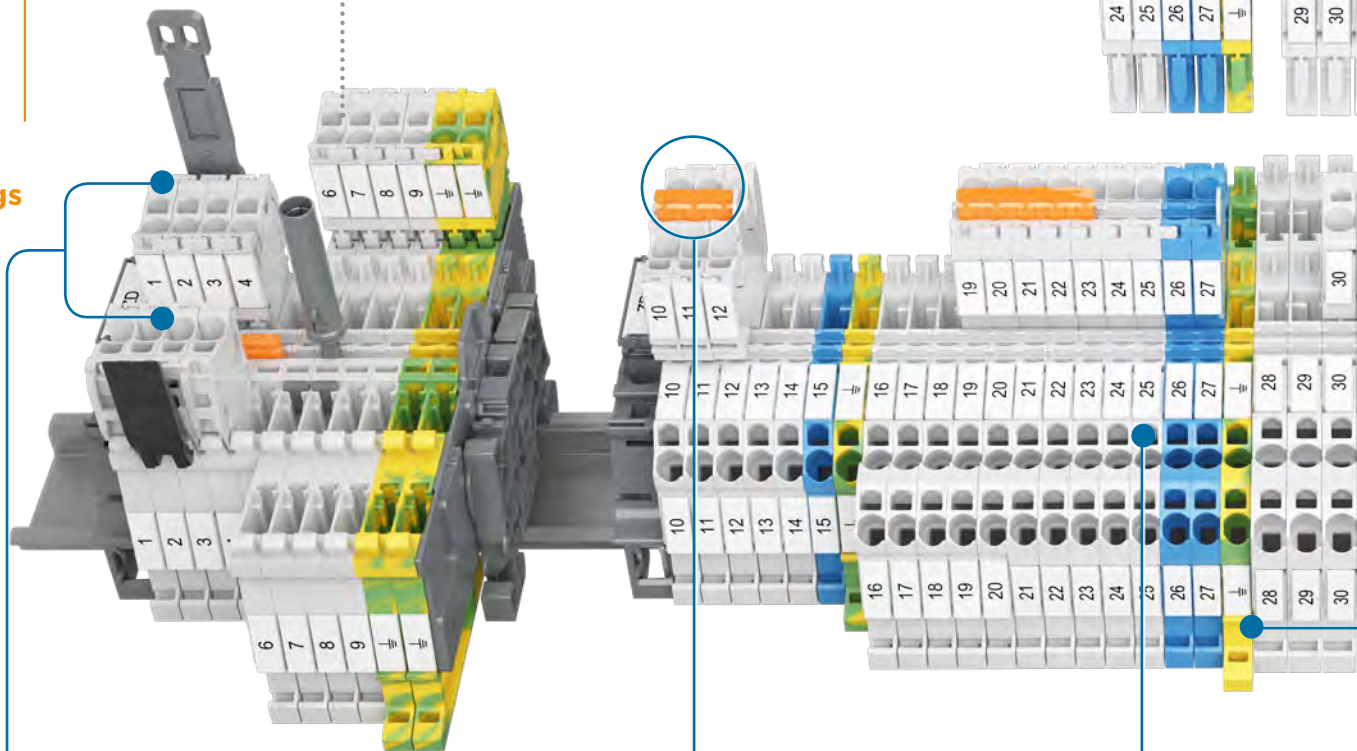

#### Compact plug

Save up to 15% in height

#### Jumper plugs

Plugs with 1 or 2 connection & jumper to ease potential distribution

#### Reduced plug variants

Only two plugs variants to create assemblies

#### Voltage test

Screwdriver entry point accepts category II probes

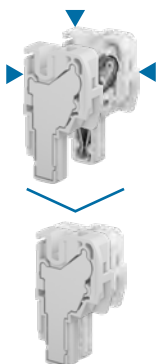



# 2x2

Connections

**Double deck**  
Feed-through  
Ground

## Screw clamp Pluggable

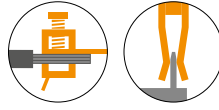

# 4

Connections

**Single deck**  
Feed-through

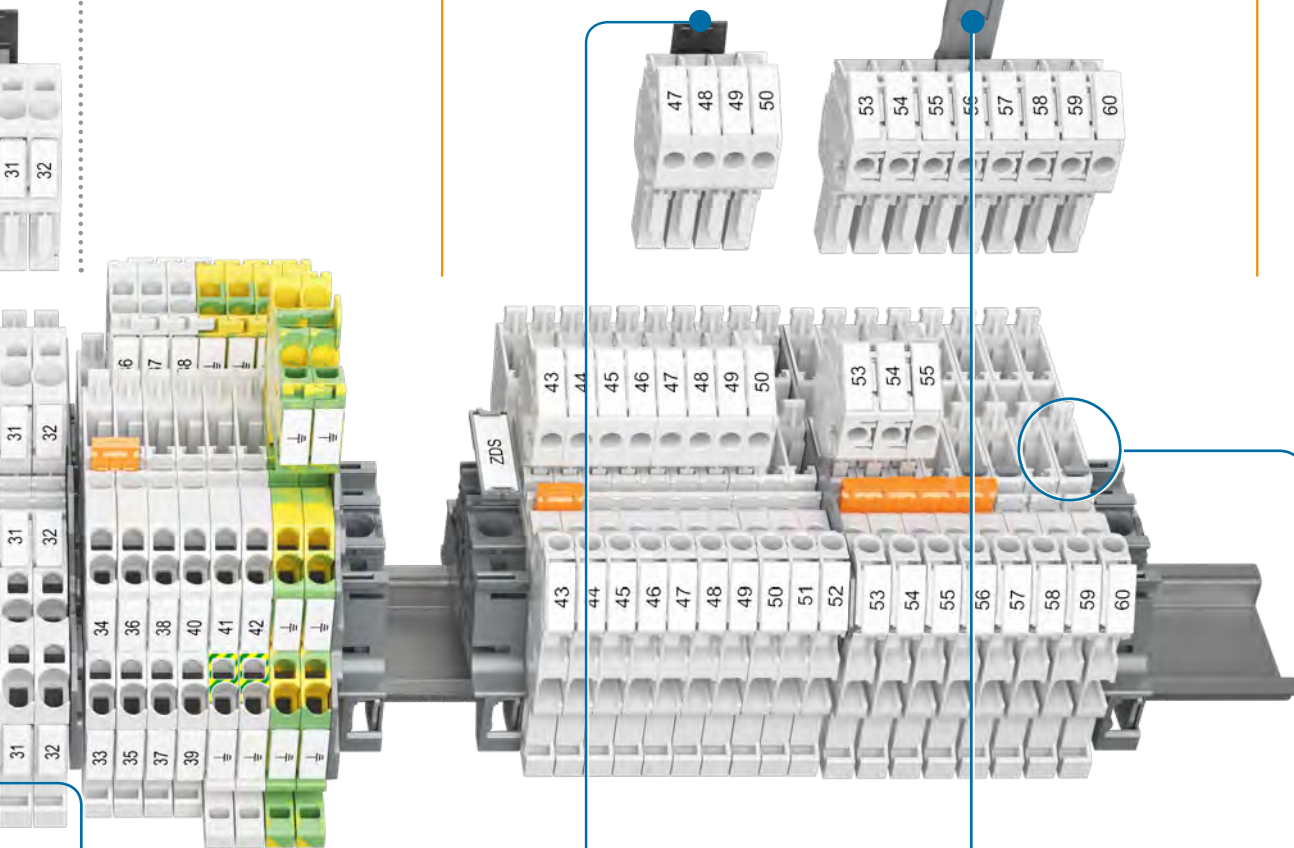

### End section

No need of end section between 2.5 and 4 mm<sup>2</sup> terminal blocks



### Locking device

Secure plug and wiring against accidental pulling

### Cable clamp

Secure the wires onto the plug when pulling the plug assembly

### Convenient coding pegs

Guarantee error free plugs insertion



15NKT164013S0201

# SNK series, terminal blocks

## Pluggable technology



### PI-Spring Pluggable

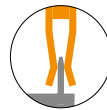

#### Single deck



Section		Feed-through		Ground	Feed-through		Ground	
2.5 mm <sup>2</sup>	12 AWG	ZD2.5-11	ZD2.5-22	ZD2.5-22-PE	ZDK2.5-11	ZDK2.5-21	ZDK2.5-22	ZDK2.5-11-PE
4 mm <sup>2</sup>	10 AWG					ZDK4-22		ZDK2.5-22-PE

#### Double deck

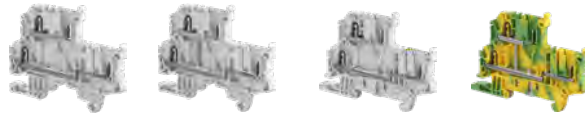

Section		Feed-through	Feed-through + ground	Ground
2.5 mm <sup>2</sup>	12 AWG	ZDK2.5-D2	ZDK2.5-D1	ZDK2.5-D2-PE
4 mm <sup>2</sup>	10 AWG			ZDK2.5-D1-PE

#### PI-Spring female plugs



Section		Closed		Closed		Closed		Closed		Closed		Closed	
2.5 mm <sup>2</sup>	12 AWG	CDK2.5	CDK2.5-E	CDK2.5-J	CDK2.5-J-E	CDK2.5-2P-J	CDK2.5-2P-J-E	CDK2.5-PE	CDK2.5-PE-E	CDK2.5-J-PE	CDK2.5-J-PE-E	CDK2.5-2P-J-PE	CDK2.5-2P-J-PE
4 mm <sup>2</sup>	10 AWG	CDK4	CDK4-E										



### Screw clamp Pluggable

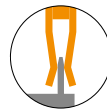

#### Single deck

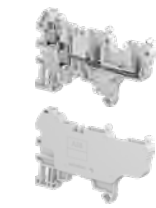

Section		Feed-through
4 mm <sup>2</sup>	10 AWG	ZDS4-22 ZDS4-22-R1

#### Screw clamp female plugs



Section		Closed	
4 mm <sup>2</sup>	10 AWG	CDS4 CDS4-R1	CDS4-E

clamp - 
 Channels for jumpering or testing - 
 test socket - 
 Blown-fuse indicator - 
 male pluggable clamp - 
 female pluggable clamp

## PI-Spring Pluggable

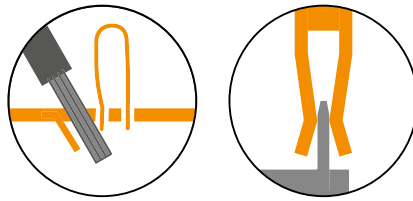

# ZD2.5-11 PI-Spring pluggable terminal blocks

## Feed-through - 5.2 mm 0.205 in spacing



2.5 mm<sup>2</sup>  
12 AWG

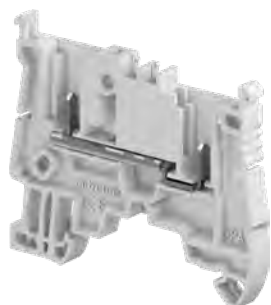

1SNK805016R0000

ZD2.5-11

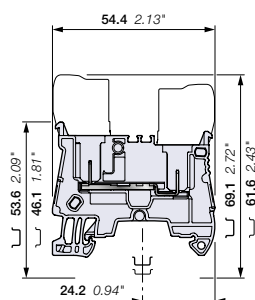

5.2 mm 0.205 in spacing

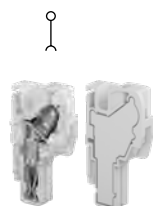

CDK2.5 CDK2.5-E



### Description

- Increase your productivity with pluggable terminal blocks: possibility of pre-produced plugs harnesses, time saving plug and play assembly, reduced transportation panels preparation and final installation, easily connect sub-assemblies together,
- Simplify and secure your installation: in site faulty connection errors are eliminated, prior connection testing is eased and reliable, test connectors (TC5) withstanding 10 000 operations are compatible for convenient testing.

### Ordering details

Description	Color	Type	Part Number	Pkg qty	Weight (1 pce) g
Feed-through 2 connections	Grey <input type="checkbox"/>	ZD2.5-11	1SNK805016R0000	50	5.66

### Main technical data

Connecting capacity	IEC	UL - CSA	Mounting instructions
<b>1 conductor per clamp</b>	Rigid: Solid/Stranded Flexible without ferrule Flexible with non insulated ferrule Flexible with insulated ferrule	0.2 ... 4 mm <sup>2</sup> 0.22 ... 2.5 mm <sup>2</sup> 0.22 ... 2.5 mm <sup>2</sup> 0.22 ... 2.5 mm <sup>2</sup>	26 ... 12 AWG 26 ... 14 AWG 26 ... 14 AWG 26 ... 14 AWG
<b>2 conductors per clamp</b>	Flexible with twin ferrule	0.22 ... 0.5 mm <sup>2</sup>	26 ... 20 AWG
<b>Rated current / Rated cross section</b>	22 A / 2.5 mm <sup>2</sup>	20 A / 12 AWG	
<b>Rated short-time withstand current (1s)</b>	300 A		
<b>Rated voltage</b>	1000 V	600 V	
<b>Impulse withstand voltage</b>	8000 V		
<b>Protection</b>	IP20	NEMA 1	

The connecting capacity data for one Rigid: Solid/Stranded, or one Flexible conductor (when applicable) is a mandatory information required by IEC, UL and CSA standards (Copper conductors). All other data are provided as supplementary information only. For more details, please consult our CB, UL or CSA certificates and technical datasheet available on <http://www.TE.com>

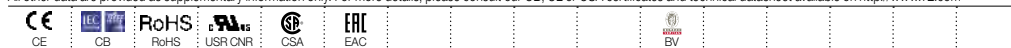

### Female plugs

Description	Color	Type	Part Number	Pkg qty	Weight (1 pce) g
Female plugs 1 pole	Grey <input type="checkbox"/>	CDK2.5	1SNK805712R0000	50	2.80
Female plugs without outer nubs - Closed 15 poles max.		CDK2.5-E	1SNK805713R0000	50	2.88

### Accessories

Description	Color	Type	Part Number	Pkg qty	Weight (1 pce) g	
1 End stops 5.2 mm 0.205 in	Dark grey <input type="checkbox"/>	BAZ1	1SNK900002R0000	50	5.30	
2 End sections 1.5 mm 0.059 in	Dark grey <input type="checkbox"/>	EDK2.5-11	1SNK805915R0000	20	1.49	
3 Jumper bars 2 poles 32 A (IEC)	Orange <input type="checkbox"/>	JB5-2	1SNK905302R0000	50	1.30	
		3 poles 32 A (IEC)	JB5-3	1SNK905303R0000	50	2.00
		4 poles 32 A (IEC)	JB5-4	1SNK905304R0000	50	2.70
		5 poles 32 A (IEC)	JB5-5	1SNK905305R0000	50	3.50
		10 poles 32 A (IEC)	JB5-10	1SNK905310R0000	30	7.10
50 poles 32 A (IEC)	JB5-50	1SNK905350R0000	10	36.00		
4 Cross spacing jumpers 3 poles 32 A (IEC)	Orange <input type="checkbox"/>	JB85-3	1SNK900603R0000	10	2.80	
5 Circuit separators 3 mm 0.118 in	Dark grey <input type="checkbox"/>	CS-R2	1SNK900106R0000	20	3.80	
6 Test adapters For test plugs DIA 2 mm 0.079 in	Dark grey <input type="checkbox"/>	TP2	1SNK900203R0000	20	1.70	
		TP4	1SNK900205R0000	20	2.40	
7 Test connectors 5.2 mm 0.205 in spacing	Dark grey <input type="checkbox"/>	TC5	1SNK900200R0000	10	5.20	
		TC5-R1	1SNK900201R0000	10	5.20	
8 Coding pegs End module, 5.2 mm 0.205 in	Dark grey <input type="checkbox"/>	COP-ZD	1SNK900636R0000	10	3.57	
9 Terminal block markers	White <input type="checkbox"/>	MC512	1SNK140000R0000	22	9.00	
		MC512PA	1SNK149999R0000	20	10.00	
		MG-CPM 13 41790	1SNB041790R0512	1960	0.236	
Universal wire markers holder	Grey <input type="checkbox"/>	UMH	1SNK900611R0000	10	0.20	

Complete list of accessories is indicated in the terminal block datasheet including end stops.

Some accessories such as jumper bars may modify the terminal block's ratings: Complete information available in the accessories section of the catalog.

Technical data valid for copper conductors only.

# ZD2.5-22 PI-Spring pluggable terminal blocks

## Feed-through - 5.2 mm 0.205 in spacing

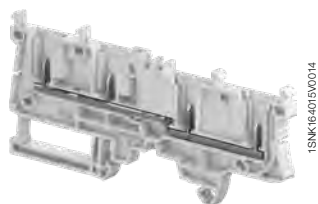

1SNK805017R0000

ZD2.5-22

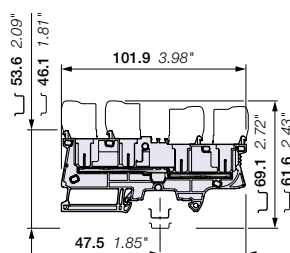

5.2 mm 0.205 in spacing

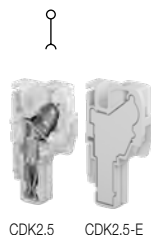

CDK2.5 CDK2.5-E

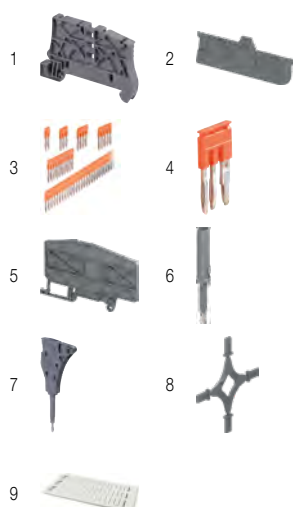

### Description

- Increase your productivity with pluggable terminal blocks: possibility of pre-produced plugs harnesses, time saving plug and play assembly, reduced transportation panels preparation and final installation, easily connect sub-assemblies together,
- Simplify and secure your installation: in site faulty connection errors are eliminated, prior connection testing is eased and reliable, test connectors (TC5) withstanding 10 000 operations are compatible for convenient testing.

### Ordering details

Description	Color	Type	Part Number	Pkg qty	Weight (1 pce) g
Feed-through 4 connections	Grey <input type="checkbox"/>	ZD2.5-22	1SNK805017R0000	50	12.00

### Main technical data

Connecting capacity	IEC	UL - CSA	Rail	TH 35-7.5, TH 35-15
1 conductor per clamp	Rigid: Solid/Stranded	0.2 ... 4 mm <sup>2</sup>	26 ... 12 AWG	
	Flexible without ferrule	0.22 ... 2.5 mm <sup>2</sup>		11 mm 0.433 in
	Flexible with non insulated ferrule	0.22 ... 2.5 mm <sup>2</sup>	26 ... 14 AWG	
	Flexible with insulated ferrule	0.22 ... 2.5 mm <sup>2</sup>	26 ... 14 AWG	
2 conductors per clamp	Flexible with twin ferrule	0.22 ... 0.5 mm <sup>2</sup>	26 ... 20 AWG	
Rated current / Rated cross section	22 A / 2.5 mm <sup>2</sup>	20 A / 12 AWG		
Rated short-time withstand current (1s)	300 A			
Rated voltage	1000 V	600 V		
Impulse withstand voltage	8000 V			
Protection	IP20	NEMA 1		

### Mounting instructions

Wire stripping length	Tool (for flexible conductor without ferrule)	Flat screwdriver
		Ø 3.5 mm Ø 0.138 in

The connecting capacity data for one Rigid: Solid/Stranded, or one Flexible conductor (when applicable) is a mandatory information required by IEC, UL and CSA standards (Copper conductors). All other data are provided as supplementary information only. For more details, please consult our CB, UL or CSA certificates and technical datasheet available on <http://www.TE.com>

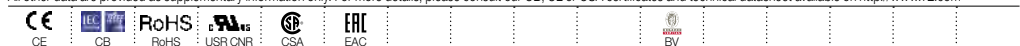

### Female plugs

Description	Color	Type	Part Number	Pkg qty	Weight (1 pce) g
Female plugs 1 pole	Grey <input type="checkbox"/>	CDK2.5	1SNK805712R0000	50	2.80
Female plugs without outer nubs - Closed		CDK2.5-E	1SNK805713R0000	50	2.88

15 poles max.

### Accessories

Description	Color	Type	Part Number	Pkg qty	Weight (1 pce) g	
1 End stops 5.2 mm 0.205 in	Dark grey <input type="checkbox"/>	BAZ1	1SNK900002R0000	50	5.30	
2 End sections 2.0 mm 0.079 in	Dark grey <input type="checkbox"/>	ED2.5-22	1SNK805917R0000	20	3.64	
3 Jumper bars	Orange <input type="checkbox"/>	2 poles 32 A (IEC)	JB5-2	1SNK905302R0000	50	1.30
		3 poles 32 A (IEC)	JB5-3	1SNK905303R0000	50	2.00
		4 poles 32 A (IEC)	JB5-4	1SNK905304R0000	50	2.70
		5 poles 32 A (IEC)	JB5-5	1SNK905305R0000	50	3.50
		10 poles 32 A (IEC)	JB5-10	1SNK905310R0000	30	7.10
		50 poles 32 A (IEC)	JB5-50	1SNK905350R0000	10	36.00
4 Cross spacing jumpers 3 poles 32 A (IEC)	Orange <input type="checkbox"/>	JB85-3	1SNK900603R0000	10	2.80	
5 Circuit separators 3 mm 0.118 in	Dark grey <input type="checkbox"/>	CS-R3	1SNK900107R0000	20	6.40	
6 Test adapters	Dark grey <input type="checkbox"/>	For test plugs DIA 2 mm 0.079 in	TP2	1SNK900203R0000	20	1.70
		For test plugs DIA 4 mm 0.157 in	TP4	1SNK900205R0000	20	2.40
7 Test connectors	Dark grey <input type="checkbox"/>	5.2 mm 0.205 in spacing	TC5	1SNK900200R0000	10	5.20
		End module, 5.2 mm 0.205 in	TC5-R1	1SNK900201R0000	10	5.20
			COP-ZD	1SNK900636R0000	10	3.57
8 Coding pegs	Dark grey <input type="checkbox"/>		MC512	1SNK140000R0000	22	9.00
			MC512PA	1SNK149999R0000	20	10.00
			MG-CPM 13 41790	1SNB041790R0512	1960	0.236
			UMH	1SNK900611R0000	10	0.20
9 Terminal block markers	White <input type="checkbox"/>	Blank card				
		Blank marker				
		Universal wire markers holder	Grey <input type="checkbox"/>			

Complete list of accessories is indicated in the terminal block datasheet including end stops.

Some accessories such as jumper bars may modify the terminal block's ratings: Complete information available in the accessories section of the catalog.

Technical data valid for copper conductors only.

1SNK16402150201



# ZD2.5-22-PE PI-Spring pluggable terminal blocks

Ground - 5.2 mm 0.205 in spacing

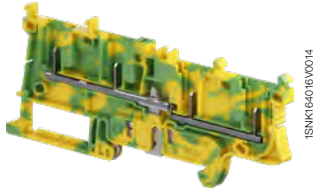

1SNK1640REV0014

ZD2.5-22-PE

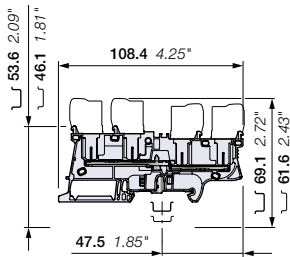

5.2 mm 0.205 in spacing

## Description

- Increase your productivity with pluggable terminal blocks: possibility of pre-produced plugs harnesses, time saving plug and play assembly, reduced transportation panels preparation and final installation, easily connect sub-assemblies together,
- Simplify and secure your installation: in site faulty connection errors are eliminated, prior connection testing is eased and reliable, test connectors (TC5) withstanding 10 000 operations are compatible for convenient testing.

## Ordering details

Description	Color	Type	Part Number	Pkg qty	Weight (1 pce) g
Ground 4 connections	Green-yellow	ZD2.5-22-PE	1SNK805156R0000	50	14.80

## Main technical data

Connecting capacity	IEC	UL - CSA	Mounting instructions		
1 conductor per clamp	Rigid: Solid/Stranded	0.2 ... 4 mm <sup>2</sup>	26 ... 12 AWG	Rail	TH 35-7.5, TH 35-15
	Flexible without ferrule	0.22 ... 2.5 mm <sup>2</sup>		Wire stripping length	11 mm 0.433 in
	Flexible with non insulated ferrule	0.22 ... 2.5 mm <sup>2</sup>	26 ... 14 AWG		Tool (for flexible conductor without ferrule)
	Flexible with insulated ferrule	0.22 ... 2.5 mm <sup>2</sup>	26 ... 14 AWG		
Rated cross section	2.5 mm <sup>2</sup>	12 AWG			
Rated short-time withstand current (1s)	300 A	396 A			
Protection	IP20	NEMA 1			

The connecting capacity data for one Rigid: Solid/Stranded, or one Flexible conductor (when applicable) is a mandatory information required by IEC, UL and CSA standards (Copper conductors). All other data are provided as supplementary information only. For more details, please consult our CB, UL or CSA certificates and technical datasheet available on <http://www.TE.com>



CDK2.5-PE CDK2.5-PE-E

## Female plugs

Description	Color	Type	Part Number	Pkg qty	Weight (1 pce) g
Female plugs 1 pole	Green-yellow	CDK2.5-PE	1SNK805750R0000	50	2.80
Female plugs without outer nubs - Closed 15 poles max.		CDK2.5-PE-E	1SNK805753R0000	50	2.88

## Accessories

Description	Color	Type	Part Number	Pkg qty	Weight (1 pce) g	
1 End stops 5.2 mm 0.205 in	Dark grey	BAZ1	1SNK900002R0000	50	5.30	
2 End sections 2.0 mm 0.079 in	Dark grey	ED2.5-22	1SNK805917R0000	20	3.64	
3 Circuit separators 3 mm 0.118 in	Dark grey	CS-R3	1SNK900107R0000	20	6.40	
4 Test adapters	Dark grey	For test plugs DIA 2 mm 0.079 in	TP2	1SNK900203R0000	20	1.70
		For test plugs DIA 4 mm 0.157 in	TP4	1SNK900205R0000	20	2.40
5 Test connectors 5.2 mm 0.205 in spacing	Dark grey	End module, 5.2 mm 0.205 in	TC5	1SNK900200R0000	10	5.20
			TC5-R1	1SNK900201R0000	10	5.20
6 Coding pegs	Dark grey	COP-ZD	1SNK900636R0000	10	3.57	
7 Terminal block markers	White	Blank card	MC512	1SNK140000R0000	22	9.00
			MC512PA	1SNK149999R0000	20	10.00
		Blank marker	MG-CPM 13 41790	1SNB041790R0512	1960	0.236
		Universal wire markers holder	Grey	UMH	1SNK900611R0000	10

Complete list of accessories is indicated in the terminal block datasheet including end stops. Some accessories such as jumper bars may modify the terminal block's ratings: Complete information available in the accessories section of the catalog.

Technical data valid for copper conductors only.

1SNK1640ZS0201

# ZDK2.5-11 PI-Spring pluggable terminal blocks

Feed-through - 5.2 mm 0.205 in spacing

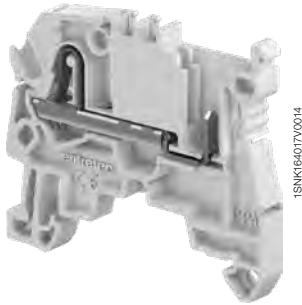

ZDK2.5-11

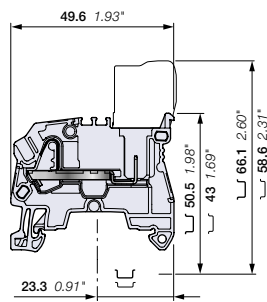

5.2 mm 0.205 in spacing

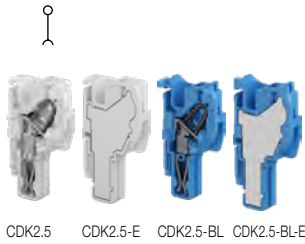

CDK2.5 CDK2.5-E CDK2.5-BL CDK2.5-BL-E



## Description

- Increase your productivity with pluggable terminal blocks: possibility of pre-produced plugs harnesses, time saving plug and play assembly, reduced transportation panels preparation and final installation, easily connect sub-assemblies together,
- Simplify and secure your installation: in site faulty connection errors are eliminated, prior connection testing is eased and reliable, test connectors (TC5) withstanding 10 000 operations are compatible for convenient testing.

## Ordering details

Description	Color	Type	Part Number	Pkg qty	Weight (1 pce) g
Feed-through 2 connections	Grey <input type="checkbox"/>	ZDK2.5-11	1SNK805015R0000	50	7.00
	Blue <input type="checkbox"/>	ZDK2.5-11-BL	1SNK805025R0000	50	7.00

## Main technical data

Connecting capacity	IEC	UL - CSA	Mounting instructions
1 conductor per clamp	Rigid: Solid/Stranded	0.2 ... 4 mm <sup>2</sup>	26 ... 12 AWG
	Flexible without ferrule	0.22 ... 2.5 mm <sup>2</sup>	26 ... 14 AWG
	Flexible with non insulated ferrule	0.22 ... 2.5 mm <sup>2</sup>	26 ... 14 AWG
	Flexible with insulated ferrule	0.22 ... 2.5 mm <sup>2</sup>	26 ... 14 AWG
2 conductors per clamp	Flexible with twin ferrule	0.22 ... 0.5 mm <sup>2</sup>	26 ... 20 AWG
Rated current / Rated cross section	24 A / 2.5 mm <sup>2</sup>	20 A / 12 AWG	
Rated short-time withstand current (1s)	300 A		
Rated voltage	1000 V	600 V	
Impulse withstand voltage	8000 V		
Protection	IP20	NEMA 1	

The connecting capacity data for one Rigid: Solid/Stranded, or one Flexible conductor (when applicable) is a mandatory information required by IEC, UL and CSA standards (Copper conductors). All other data are provided as supplementary information only. For more details, please consult our CB, UL or CSA certificates and technical datasheet available on <http://www.TE.com>



## Female plugs

Description	Color	Type	Part Number	Pkg qty	Weight (1 pce) g
Female plugs 1 pole	Grey <input type="checkbox"/>	CDK2.5	1SNK805712R0000	50	2.80
Female plugs without outer nubs - Closed		CDK2.5-E	1SNK805713R0000	50	2.88
Female plugs 1 pole	Blue <input type="checkbox"/>	CDK2.5-BL	1SNK805742R0000	50	2.80
Female plugs without outer nubs - Closed		CDK2.5-BL-E	1SNK805743R0000	50	2.88

15 poles max.

## Accessories

Description	Color	Type	Part Number	Pkg qty	Weight (1 pce) g	
1 End stops 5.2 mm 0.205 in	Dark grey <input type="checkbox"/>	BAZ1	1SNK900002R0000	50	5.30	
2 End sections 1.5 mm 0.059 in	Dark grey <input type="checkbox"/>	EDK2.5-11	1SNK805915R0000	20	1.49	
3 Jumper bars	Orange <input type="checkbox"/>	2 poles 32 A (IEC)	JB5-2	1SNK905302R0000	50	1.30
		3 poles 32 A (IEC)	JB5-3	1SNK905303R0000	50	2.00
		4 poles 32 A (IEC)	JB5-4	1SNK905304R0000	50	2.70
		5 poles 32 A (IEC)	JB5-5	1SNK905305R0000	50	3.50
		10 poles 32 A (IEC)	JB5-10	1SNK905310R0000	30	7.10
		50 poles 32 A (IEC)	JB5-50	1SNK905350R0000	10	36.00
4 Cross spacing jumpers 3 poles 32 A (IEC)	Orange <input type="checkbox"/>	JB85-3	1SNK900603R0000	10	2.80	
5 Circuit separators 3 mm 0.118 in	Dark grey <input type="checkbox"/>	CS-R2	1SNK900106R0000	20	3.80	
6 Test adapters	Dark grey <input type="checkbox"/>	For test plugs DIA 2 mm 0.079 in	TP2	1SNK900203R0000	20	1.70
		For test plugs DIA 4 mm 0.157 in	TP4	1SNK900205R0000	20	2.40
7 Test connectors	Dark grey <input type="checkbox"/>	5.2 mm 0.205 in spacing	TC5	1SNK900200R0000	10	5.20
		End module, 5.2 mm 0.205 in	TC5-R1	1SNK900201R0000	10	5.20
8 Coding pegs	Dark grey <input type="checkbox"/>	COP-ZD	1SNK900636R0000	10	3.57	
9 Terminal block markers	White <input type="checkbox"/>	Blank card	MC512	1SNK140000R0000	22	9.00
		Blank marker	MG-CPM 13 41790	1SNB041790R0512	1960	0.236
		Universal wire markers holder	UMH	1SNK900611R0000	10	0.20

Complete list of accessories is indicated in the terminal block datasheet including end stops.

Some accessories such as jumper bars may modify the terminal block's ratings: Complete information available in the accessories section of the catalog.

Technical data valid for copper conductors only.

1SNK164-0235/0201

# ZDK2.5-21 PI-Spring pluggable terminal blocks

Feed-through - 5.2 mm 0.205 in spacing

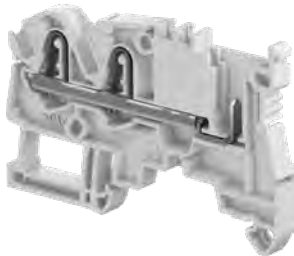

1SNK164020V0014

ZDK2.5-21

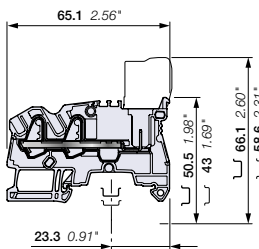

5.2 mm 0.205 in spacing



CDK2.5 CDK2.5-E

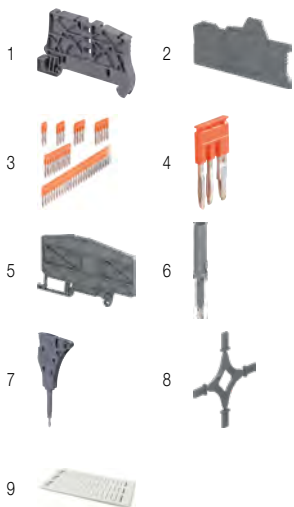

## Description

- Increase your productivity with pluggable terminal blocks: possibility of pre-produced plugs harnesses, time saving plug and play assembly, reduced transportation panels preparation and final installation, easily connect sub-assemblies together,
- Simplify and secure your installation: in site faulty connection errors are eliminated, prior connection testing is eased and reliable, test connectors (TC5) withstanding 10 000 operations are compatible for convenient testing.

## Ordering details

Description	Color	Type	Part Number	Pkg qty	Weight (1 pce) g
Feed-through 3 connections	Grey <input type="checkbox"/>	ZDK2.5-21	1SNK805014R0000	50	7.47

## Main technical data

Connecting capacity	IEC	UL - CSA	Rail	TH 35-7.5, TH 35-15	
1 conductor per clamp	Rigid: Solid/Stranded	0.2 ... 4 mm <sup>2</sup>	26 ... 12 AWG	Wire stripping length	11 mm 0.433 in
	Flexible without ferrule	0.22 ... 2.5 mm <sup>2</sup>			
	Flexible with non insulated ferrule	0.22 ... 2.5 mm <sup>2</sup>	26 ... 14 AWG		
	Flexible with insulated ferrule	0.22 ... 2.5 mm <sup>2</sup>	26 ... 14 AWG		
2 conductors per clamp	Flexible with twin ferrule	0.22 ... 0.5 mm <sup>2</sup>	26 ... 20 AWG	Tool (for flexible conductor without ferrule)	Flat screwdriver Ø 3.5 mm Ø 0.138 in
Rated current / Rated cross section		24 A / 2.5 mm <sup>2</sup>	20 A / 12 AWG		
Rated short-time withstand current (1s)		300 A			
Rated voltage		1000 V	600 V		
Impulse withstand voltage		8000 V			
Protection		IP20	NEMA 1		

The connecting capacity data for one Rigid: Solid/Stranded, or one Flexible conductor (when applicable) is a mandatory information required by IEC, UL and CSA standards (Copper conductors). All other data are provided as supplementary information only. For more details, please consult our CB, UL or CSA certificates and technical datasheet available on <http://www.TE.com>



## Female plugs

Description	Color	Type	Part Number	Pkg qty	Weight (1 pce) g
Female plugs 1 pole	Grey <input type="checkbox"/>	CDK2.5	1SNK805712R0000	50	2.80
Female plugs without outer nubs - Closed 15 poles max.		CDK2.5-E	1SNK805713R0000	50	2.88

## Accessories

Description	Color	Type	Part Number	Pkg qty	Weight (1 pce) g	
1 End stops 5.2 mm 0.205 in	Dark grey <input type="checkbox"/>	BAZ1	1SNK900002R0000	50	5.30	
2 End sections 1.5 mm 0.059 in	Dark grey <input type="checkbox"/>	EDK2.5-21	1SNK805914R0000	20	1.90	
3 Jumper bars 2 poles 32 A (IEC)	Orange <input type="checkbox"/>	JB5-2	1SNK905302R0000	50	1.30	
		3 poles 32 A (IEC)	JB5-3	1SNK905303R0000	50	2.00
		4 poles 32 A (IEC)	JB5-4	1SNK905304R0000	50	2.70
		5 poles 32 A (IEC)	JB5-5	1SNK905305R0000	50	3.50
		10 poles 32 A (IEC)	JB5-10	1SNK905310R0000	30	7.10
		50 poles 32 A (IEC)	JB5-50	1SNK905350R0000	10	36.00
4 Cross spacing jumpers 3 poles 32 A (IEC)	Orange <input type="checkbox"/>	JB85-3	1SNK900603R0000	10	2.80	
5 Circuit separators 3 mm 0.118 in	Dark grey <input type="checkbox"/>	CS-R3	1SNK900107R0000	20	6.40	
6 Test adapters For test plugs DIA 2 mm 0.079 in	Dark grey <input type="checkbox"/>	TP2	1SNK900203R0000	20	1.70	
		TP4	1SNK900205R0000	20	2.40	
7 Test connectors 5.2 mm 0.205 in spacing	Dark grey <input type="checkbox"/>	TC5	1SNK900200R0000	10	5.20	
		TC5-R1	1SNK900201R0000	10	5.20	
8 Coding pegs End module, 5.2 mm 0.205 in	Dark grey <input type="checkbox"/>	COP-ZD	1SNK900636R0000	10	3.57	
9 Terminal block markers	White <input type="checkbox"/>	MC512	1SNK140000R0000	22	9.00	
		MC512PA	1SNK149999R0000	20	10.00	
		MG-CPM 13 41790	1SNB041790R0512	1960	0.236	
Universal wire markers holder	Grey <input type="checkbox"/>	UMH	1SNK900611R0000	10	0.20	

Complete list of accessories is indicated in the terminal block datasheet including end stops. Some accessories such as jumper bars may modify the terminal block's ratings: Complete information available in the accessories section of the catalog.

Technical data valid for copper conductors only.

# ZDK2.5-22 PI-Spring pluggable terminal blocks

## Feed-through - 5.2 mm 0.205 in spacing

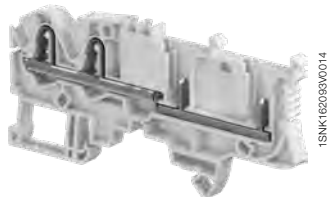

ZDK2.5-22

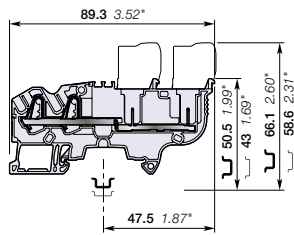

5.2 mm 0.205 in spacing

### Description

- Increase your productivity with pluggable terminal blocks: possibility of pre-produced plugs harnesses, time saving plug and play assembly, reduced transportation panels preparation and final installation, easily connect sub-assemblies together,
- Simplify and secure your installation: in site faulty connection errors are eliminated, prior connection testing is eased and reliable, test connectors (TC5) withstanding 10 000 operations are compatible for convenient testing.

### Ordering details

Description	Color	Type	Part number	Pkg qty	Weight (1 pce) g
Feed-through 4 connections	Grey <input type="checkbox"/>	ZDK2.5-22	1SNK805010R0000	50	9.60
Feed-through 4 connections	Blue <input type="checkbox"/>	ZDK2.5-22-BL	1SNK805020R0000	50	9.60

### Main technical data

Connecting capacity	IEC	UL - CSA	Mounting instructions
1 conductor per clamp	Rigid: Solid/Stranded	0.2 ... 4 mm <sup>2</sup>	26 ... 12 AWG
	Flexible without ferrule	0.22 ... 2.5 mm <sup>2</sup>	26 ... 14 AWG
	Flexible with non insulated ferrule	0.22 ... 2.5 mm <sup>2</sup>	26 ... 14 AWG
	Flexible with insulated ferrule	0.22 ... 2.5 mm <sup>2</sup>	26 ... 14 AWG
2 conductors per clamp	Flexible with twin ferrule	0.22 ... 0.5 mm <sup>2</sup>	26 ... 20 AWG
Rated current / Rated cross section		24 A / 2.5 mm <sup>2</sup>	22 A / 12 AWG
Rated short-time withstand current (1s)		300 A	
Rated voltage		1000 V	600 V
Impulse withstand voltage		8000 V	
Protection		IP20	NEMA 1

The connecting capacity data for one Rigid: Solid/Stranded, or one Flexible conductor (when applicable) is a mandatory information required by IEC, UL and CSA standards (Copper conductors). All other data are provided as supplementary information only. For more details, please consult our CB, UL or CSA certificates and technical datasheet available on <http://www.TE.com>

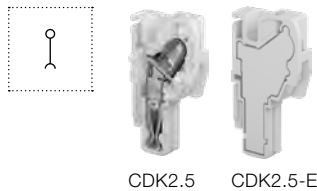

CDK2.5 CDK2.5-E

### Female plugs

Description	Color	Type	Part number	Pkg qty	Weight (1 pce) g
Female plugs 1 pole	Grey <input type="checkbox"/>	CDK2.5	1SNK805712R0000	50	2.80
Female plugs without outer nubs - Closed 15 poles max.		CDK2.5-E	1SNK805713R0000	50	2.80

### Accessories



Description	Color	Type	Part number	Pkg qty	Weight (1 pce) g	
1 End stops 5.2 mm 0.205 in	Dark grey <input type="checkbox"/>	BAZ1	1SNK900002R0000	50	5.30	
2 End sections 2.2 mm 0.087 in	Dark grey <input type="checkbox"/>	EDK2.5-22	1SNK805910R0000	20	3.15	
3 Jumper bars	Orange <input type="checkbox"/>	2 poles 32 A (IEC)	JB5-2	1SNK905302R0000	50	1.30
		3 poles 32 A (IEC)	JB5-3	1SNK905303R0000	50	2.00
		4 poles 32 A (IEC)	JB5-4	1SNK905304R0000	50	2.70
		5 poles 32 A (IEC)	JB5-5	1SNK905305R0000	50	3.50
		10 poles 32 A (IEC)	JB5-10	1SNK905310R0000	30	7.10
		50 poles 32 A (IEC)	JB5-50	1SNK905350R0000	10	36.00
4 Cross spacing jumpers 3 poles 32 A (IEC)	Orange <input type="checkbox"/>	JB85-3	1SNK900603R0000	10	2.80	
5 Circuit separators 3 mm 0.118 in	Dark grey <input type="checkbox"/>	CS-R3	1SNK900107R0000	20	6.40	
6 Test adapters	Dark grey <input type="checkbox"/>	For test plugs DIA 2 mm 0.079 in	TP2	1SNK900203R0000	20	1.70
		For test plugs DIA 4 mm 0.157 in	TP4	1SNK900205R0000	20	2.40
		5.2 mm 0.205 in spacing	TC5	1SNK900200R0000	10	5.20
7 Test connectors	Dark grey <input type="checkbox"/>	End module, 5.2 mm 0.205 in	TC5-R1	1SNK900201R0000	10	5.20
			COP-ZD	1SNK900636R0000	10	3.57
8 Coding pegs	Dark grey <input type="checkbox"/>		MG-CPM 13 41790	1SNB041790R0512	1960	0.23
			MC512	1SNK140000R0000	22	9.00
			MC512PA	1SNK149999R0000	20	10.00
			UMH	1SNK900611R0000	10	0.20
9 Terminal block markers	White <input type="checkbox"/>	Blank marker				
		Blank card				

Complete list of accessories is indicated in the terminal block datasheet including end stops.

Some accessories such as jumper bars may modify the terminal block's ratings: Complete information available in the accessories section of the catalog.

Technical data valid for copper conductors only.



# ZDK4-22 PI-Spring pluggable terminal blocks

## Feed-through - 6 mm 0.236 in spacing

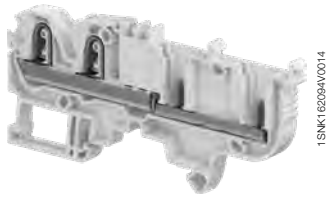

ZDK4-22

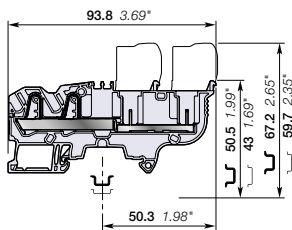

6 mm 0.236 in spacing

### Description

- Increase your productivity with pluggable terminal blocks: possibility of pre-produced plugs harnesses, time saving plug and play assembly, reduced transportation panels preparation and final installation, easily connect sub-assemblies together,
- Simplify and secure your installation: in site faulty connection errors are eliminated, prior connection testing is eased and reliable, test connectors (TC5-R1 + ES-TC6) withstanding 10 000 operations are compatible for convenient testing.

### Ordering details

Description	Color	Type	Part Number	Pkg qty	Weight (1 pce) g
Feed-through 4 connections	Grey <input type="checkbox"/>	ZDK4-22	1SNK806010R0000	50	14.30

### Main technical data

Connecting capacity		IEC	UL - CSA
1 conductor per clamp	Rigid: Solid/Stranded	0.5 ... 6 mm <sup>2</sup>	26 ... 10 AWG
	Flexible without ferrule	0.5 ... 4 mm <sup>2</sup>	26 ... 12 AWG
	Flexible with non insulated ferrule	0.5 ... 4 mm <sup>2</sup>	26 ... 12 AWG
	Flexible with insulated ferrule	0.5 ... 4 mm <sup>2</sup>	26 ... 12 AWG
2 conductors per clamp	Flexible with twin ferrule	0.5 ... 1 mm <sup>2</sup>	26 ... 18 AWG
Rated current / Rated cross section		30 A / 4 mm <sup>2</sup>	30 A / 10 AWG
Rated short-time withstand current (1s)		480 A	
Rated voltage		1000 V	600 V
Impulse withstand voltage		8000 V	
Protection		IP20	NEMA 1

### Mounting instructions

Rail		TH 35-7.5, TH 35-15
Wire stripping length		12.5 mm 0.492 in
Tool (for flexible conductor without ferrule)		Flat screwdriver Ø 3.5 mm Ø 0.138 in

The connecting capacity data for one Rigid: Solid/Stranded, or one Flexible conductor (when applicable) is a mandatory information required by IEC, UL and CSA standards (Copper conductors). All other data are provided as supplementary information only. For more details, please consult our CB, UL or CSA certificates and technical datasheet available on <http://www.TE.com>

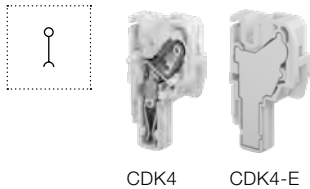
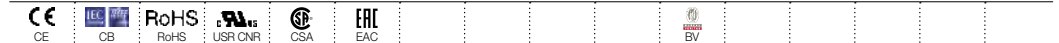

CDK4

CDK4-E

### Female plugs

Description	Color	Type	Part Number	Pkg qty	Weight (1 pce) g
Female plugs 1 pole	Grey <input type="checkbox"/>	CDK4	1SNK806712R0000	50	3.80
Female plugs without outer nubs - Closed		CDK4-E	1SNK806713R0000	50	4.50

15 poles max.

### Accessories

Description	Color	Type	Part Number	Pkg qty	Weight (1 pce) g	
1 End stops 5.2 mm 0.205 in	Dark grey <input checked="" type="checkbox"/>	BAZ1	1SNK900002R0000	50	5.30	
2 End sections 2.2 mm 0.087 in	Dark grey <input checked="" type="checkbox"/>	EDK2.5-22	1SNK805910R0000	20	3.15	
3 Jumper bars	Orange <input checked="" type="checkbox"/>	2 poles 41 A (IEC)	JB6-2	1SNK906302R0000	50	1.30
		3 poles 41 A (IEC)	JB6-3	1SNK906303R0000	50	2.10
		4 poles 41 A (IEC)	JB6-4	1SNK906304R0000	50	2.90
		5 poles 41 A (IEC)	JB6-5	1SNK906305R0000	50	3.60
		10 poles 41 A (IEC)	JB6-10	1SNK906310R0000	20	7.40
50 poles 41 A (IEC)	JB6-50	1SNK906350R0000	10	38.10		
4 Cross spacing jumpers 3 poles 32 A (IEC)	Orange <input checked="" type="checkbox"/>	JB85-3	1SNK900603R0000	10	2.80	
5 Circuit separators 3 mm 0.118 in	Dark grey <input checked="" type="checkbox"/>	CS-R3	1SNK900107R0000	20	6.40	
6 Test adapters	Dark grey <input checked="" type="checkbox"/>	For test plugs DIA 2 mm 0.079 in	TP2	1SNK900203R0000	20	1.70
		For test plugs DIA 4 mm 0.157 in	TP4	1SNK900205R0000	20	2.40
7 Test connectors	Dark grey <input checked="" type="checkbox"/>	TC5-R1	1SNK900201R0000	10	5.20	
8 Spacers 0.8 mm 0.031 in	Dark grey <input checked="" type="checkbox"/>	ES-TC6	1SNK900105R0000	10	0.80	
9 Coding pegs	Dark grey <input checked="" type="checkbox"/>		COP-ZD	1SNK900636R0000	10	3.57
		Blank marker	White <input type="checkbox"/>	MG-CPM 13 41791	1680	0.27
		Blank card		MC612	1SNK150000R0000	22
10 Terminal block markers	Grey <input type="checkbox"/>		MC612PA	1SNK159999R0000	20	11.00
		Universal wire markers holder		UMH	1SNK900611R0000	10

Complete list of accessories is indicated in the terminal block datasheet including end stops.

Some accessories such as jumper bars may modify the terminal block's ratings: Complete information available in the accessories section of the catalog.

Technical data valid for copper conductors only.



# ZDK2.5-11-PE PI-Spring pluggable terminal blocks

Ground - 5.2 mm 0.205 in spacing



1SNK164019K0014

ZDK2.5-11-PE

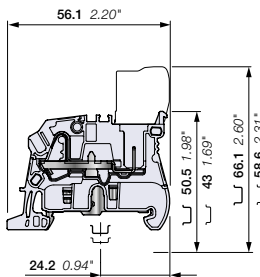

5.2 mm 0.205 in spacing



CDK2.5-PE CDK2.5-PE-E



## Description

- Increase your productivity with pluggable terminal blocks: possibility of pre-produced plugs harnesses, time saving plug and play assembly, reduced transportation panels preparation and final installation, easily connect sub-assemblies together,
- Simplify and secure your installation: in site faulty connection errors are eliminated, prior connection testing is eased and reliable, test connectors (TC5) withstanding 10 000 operations are compatible for convenient testing.

## Ordering details

Description	Color	Type	Part Number	Pkg qty	Weight (1 pce) g
Ground 2 connections	Green-yellow	ZDK2.5-11-PE	1SNK805150R0000	50	9.62

## Main technical data

Connecting capacity	IEC	UL - CSA	Mounting instructions
1 conductor per clamp	Rigid: Solid/Stranded	0.2 ... 4 mm²	26 ... 12 AWG
	Flexible without ferrule	0.22 ... 2.5 mm²	26 ... 14 AWG
	Flexible with non insulated ferrule	0.22 ... 2.5 mm²	26 ... 14 AWG
	Flexible with insulated ferrule	0.22 ... 2.5 mm²	26 ... 14 AWG
Rated cross section	2.5 mm²	12 AWG	
Rated short-time withstand current (1s)	300 A	396 A	
Protection	IP20	NEMA 1	

The connecting capacity data for one Rigid: Solid/Stranded, or one Flexible conductor (when applicable) is a mandatory information required by IEC, UL and CSA standards (Copper conductors). All other data are provided as supplementary information only. For more details, please consult our CB, UL or CSA certificates and technical datasheet available on <http://www.TE.com>

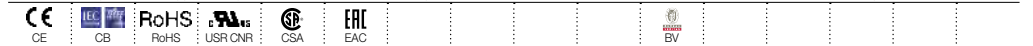

## Female plugs

Description	Color	Type	Part Number	Pkg qty	Weight (1 pce) g
Female plugs 1 pole	Green-yellow	CDK2.5-PE	1SNK805750R0000	50	2.80
Female plugs without outer nubs - Closed 15 poles max.		CDK2.5-PE-E	1SNK805753R0000	50	2.88

## Accessories

Description	Color	Type	Part Number	Pkg qty	Weight (1 pce) g	
1 End stops 5.2 mm 0.205 in	Dark grey	BAZ1	1SNK900002R0000	50	5.30	
2 End sections 1.5 mm 0.059 in	Dark grey	EDK2.5-11	1SNK805915R0000	20	1.49	
3 Circuit separators 3 mm 0.118 in	Dark grey	CS-R2	1SNK900106R0000	20	3.80	
4 Test adapters	Dark grey	For test plugs DIA 2 mm 0.079 in	TP2	1SNK900203R0000	20	1.70
		For test plugs DIA 4 mm 0.157 in	TP4	1SNK900205R0000	20	2.40
5 Test connectors 5.2 mm 0.205 in spacing	Dark grey	End module, 5.2 mm 0.205 in	TC5	1SNK900200R0000	10	5.20
			TC5-R1	1SNK900201R0000	10	5.20
6 Coding pegs	Dark grey	COP-ZD	1SNK900636R0000	10	3.57	
7 Terminal block markers	White	Blank card	MC512	1SNK140000R0000	22	9.00
			MC512PA	1SNK149999R0000	20	10.00
		Blank marker	MG-CPM 13 41790	1SNB041790R0512	1960	0.236
		Universal wire markers holder	Grey	UMH	1SNK900611R0000	10

Complete list of accessories is indicated in the terminal block datasheet including end stops. Some accessories such as jumper bars may modify the terminal block's ratings: Complete information available in the accessories section of the catalog.

Technical data valid for copper conductors only.

1SNK164024S0201

# ZDK2.5-22-PE PI-Spring pluggable terminal blocks

Feed-through - 5.2 mm 0.205 in spacing



ZDK2.5-22-PE

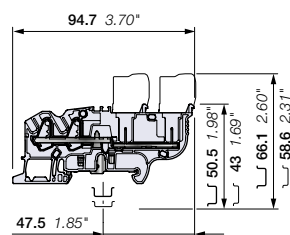

5.2 mm 0.205 in spacing

## Description

- Increase your productivity with pluggable terminal blocks: possibility of pre-produced plugs harnesses, time saving plug and play assembly, reduced transportation panels preparation and final installation, easily connect sub-assemblies together,
- Simplify and secure your installation: in site faulty connection errors are eliminated, prior connection testing is eased and reliable, test connectors (TC5) withstanding 10 000 operations are compatible for convenient testing.

## Ordering details

Description	Color	Type	Part Number	Pkg qty	Weight (1 pce) g
Ground 4 connections	Green-yellow	ZDK2.5-22-PE	1SNK805152R0000	50	14.05

## Main technical data

Connecting capacity	IEC	UL - CSA	Rail	TH 35-7.5, TH 35-15
1 conductor per clamp	Rigid: Solid/Stranded	0.2 ... 4 mm <sup>2</sup>	26 ... 12 AWG	11 mm 0.433 in
	Flexible without ferrule	0.22 ... 2.5 mm <sup>2</sup>	26 ... 14 AWG	
	Flexible with non insulated ferrule	0.22 ... 2.5 mm <sup>2</sup>	26 ... 14 AWG	
	Flexible with insulated ferrule	0.22 ... 2.5 mm <sup>2</sup>	26 ... 14 AWG	
Rated cross section	2.5 mm <sup>2</sup>	12 AWG		
Rated short-time withstand current (1s)	300 A	396 A		
Protection	IP20	NEMA 1		

## Mounting instructions

Wire stripping length	Tool (for flexible conductor without ferrule)	Flat screwdriver
		Ø 3.5 mm Ø 0.138 in

The connecting capacity data for one Rigid: Solid/Stranded, or one Flexible conductor (when applicable) is a mandatory information required by IEC, UL and CSA standards (Copper conductors). All other data are provided as supplementary information only. For more details, please consult our CB, UL or CSA certificates and technical datasheet available on <http://www.TE.com>

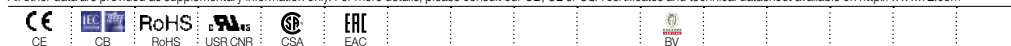

CDK2.5-PE CDK2.5-PE-E

## Female plugs

Description	Color	Type	Part Number	Pkg qty	Weight (1 pce) g
Female plugs 1 pole	Green-yellow	CDK2.5-PE	1SNK805750R0000	50	2.80
Female plugs without outer nubs - Closed 15 poles max.		CDK2.5-PE-E	1SNK805753R0000	50	2.88

## Accessories

Description	Color	Type	Part Number	Pkg qty	Weight (1 pce) g	
1 End stops 5.2 mm 0.205 in	Dark grey	BAZ1	1SNK900002R0000	50	5.30	
2 End sections 2.2 mm 0.087 in	Dark grey	EDK2.5-22	1SNK805910R0000	20	3.15	
3 Circuit separators 3 mm 0.118 in	Dark grey	CS-R3	1SNK900107R0000	20	6.40	
4 Test adapters	Dark grey	For test plugs DIA 2 mm 0.079 in	TP2	1SNK900203R0000	20	1.70
		For test plugs DIA 4 mm 0.157 in	TP4	1SNK900205R0000	20	2.40
5 Test connectors 5.2 mm 0.205 in spacing	Dark grey	End module, 5.2 mm 0.205 in	TC5	1SNK900200R0000	10	5.20
			TC5-R1	1SNK900201R0000	10	5.20
6 Coding pegs	Dark grey	COP-ZD	1SNK900636R0000	10	3.57	
7 Terminal block markers	White	Blank card	MC512	1SNK140000R0000	22	9.00
			MC512PA	1SNK149999R0000	20	10.00
		Blank marker	MG-CPM 13 41790	1SNB041790R0512	1960	0.236
		Universal wire markers holder	Grey	UMH	1SNK900611R0000	10

Complete list of accessories is indicated in the terminal block datasheet including end stops. Some accessories such as jumper bars may modify the terminal block's ratings: Complete information available in the accessories section of the catalog.

Technical data valid for copper conductors only.

# ZDK2.5-D2 PI-Spring pluggable terminal blocks

Double deck feed-through 2 circuits - 5.2 mm 0.205 in spacing

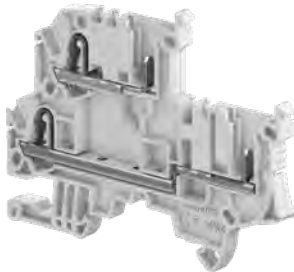

1SNK16402850014

ZDK2.5-D2

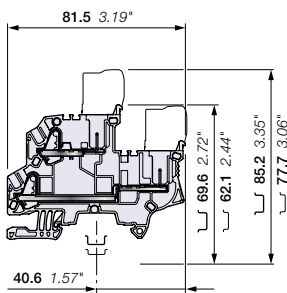

5.2 mm 0.205 in spacing

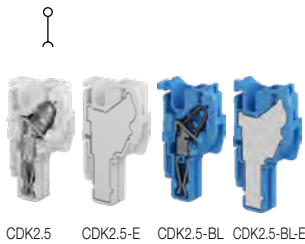

CDK2.5 CDK2.5-E CDK2.5-BL CDK2.5-BL-E



1 2 3 4 5 6 7 8

## Description

- Increase your productivity with pluggable terminal blocks: possibility of pre-produced plugs harnesses, time saving plug and play assembly, reduced transportation panels preparation and final installation, easily connect sub-assemblies together,
- Simplify and secure your installation: in site faulty connection errors are eliminated, prior connection testing is eased and reliable, test connectors (TC5) withstanding 10 000 operations are compatible for convenient testing.

## Ordering details

Description	Color	Type	Part Number	Pkg qty	Weight (1 pce) g
Feed-through double deck 4 connections	Grey <input type="checkbox"/>	ZDK2.5-D2	1SNK805213R0000	50	11.89
	Blue <input type="checkbox"/>	ZDK2.5-D2-BL	1SNK805223R0000	50	11.89

## Main technical data

Connecting capacity	IEC	UL - CSA	Mounting instructions
1 conductor per clamp	Rigid: Solid/Stranded	0.2 ... 4 mm <sup>2</sup>	26 ... 12 AWG
	Flexible without ferrule	0.22 ... 2.5 mm <sup>2</sup>	26 ... 14 AWG
	Flexible with non insulated ferrule	0.22 ... 2.5 mm <sup>2</sup>	26 ... 14 AWG
	Flexible with insulated ferrule	0.22 ... 2.5 mm <sup>2</sup>	26 ... 14 AWG
2 conductors per clamp	Flexible with twin ferrule	0.22 ... 0.5 mm <sup>2</sup>	26 ... 20 AWG
Rated current / Rated cross section	22 A / 2.5 mm <sup>2</sup>	20 A / 12 AWG	
Rated short-time withstand current (1s)	300 A		
Rated voltage	800 V	600 V	
Impulse withstand voltage	8000 V		
Protection	IP20	NEMA 1	

The connecting capacity data for one Rigid: Solid/Stranded, or one Flexible conductor (when applicable) is a mandatory information required by IEC, UL and CSA standards (Copper conductors). All other data are provided as supplementary information only. For more details, please consult our CB, UL or CSA certificates and technical datasheet available on <http://www.TE.com>

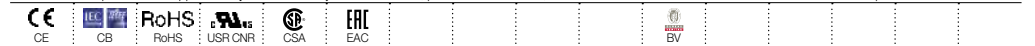

## Female plugs

Description	Color	Type	Part Number	Pkg qty	Weight (1 pce) g
Female plugs 1 pole	Grey <input type="checkbox"/>	CDK2.5	1SNK805712R0000	50	2.80
Female plugs without outer nubs - Closed		CDK2.5-E	1SNK805713R0000	50	2.88
Female plugs 1 pole	Blue <input type="checkbox"/>	CDK2.5-BL	1SNK805742R0000	50	2.80
Female plugs without outer nubs - Closed		CDK2.5-BL-E	1SNK805743R0000	50	2.88

15 poles max.

## Accessories

Description	Color	Type	Part Number	Pkg qty	Weight (1 pce) g	
1 End stops 5.2 mm 0.205 in	Dark grey <input type="checkbox"/>	BAZ1	1SNK900002R0000	50	5.30	
2 End sections 2.0 mm 0.079 in	Dark grey <input type="checkbox"/>	EDK2.5-D	1SNK805913R0000	20	3.88	
3 Jumper bars	Orange <input type="checkbox"/>	2 poles 32 A (IEC)	JB5-2	1SNK905302R0000	50	1.30
		3 poles 32 A (IEC)	JB5-3	1SNK905303R0000	50	2.00
		4 poles 32 A (IEC)	JB5-4	1SNK905304R0000	50	2.70
		5 poles 32 A (IEC)	JB5-5	1SNK905305R0000	50	3.50
		10 poles 32 A (IEC)	JB5-10	1SNK905310R0000	30	7.10
		50 poles 32 A (IEC)	JB5-50	1SNK905350R0000	10	36.00
4 Cross spacing jumpers 3 poles 32 A (IEC)	Orange <input type="checkbox"/>	JB85-3	1SNK900603R0000	10	2.80	
5 Test adapters	Dark grey <input type="checkbox"/>	For test plugs DIA 2 mm 0.079 in	TP2	1SNK900203R0000	20	1.70
		For test plugs DIA 4 mm 0.157 in	TP4	1SNK900205R0000	20	2.40
6 Test connectors	Dark grey <input type="checkbox"/>	5.2 mm 0.205 in spacing	TC5	1SNK900200R0000	10	5.20
		End module, 5.2 mm 0.205 in	TC5-R1	1SNK900201R0000	10	5.20
7 Coding pegs	Dark grey <input type="checkbox"/>	COP-ZD	1SNK900636R0000	10	3.57	
		MC512	1SNK140000R0000	22	9.00	
		MC512PA	1SNK149999R0000	20	10.00	
		MG-CPM 13 41790	1SNB041790R0512	1960	0.236	
8 Terminal block markers	White <input type="checkbox"/>	Blank card				
		Blank marker				
	Grey <input type="checkbox"/>	UMH	1SNK900611R0000	10	0.20	

Complete list of accessories is indicated in the terminal block datasheet including end stops.

Some accessories such as jumper bars may modify the terminal block's ratings: Complete information available in the accessories section of the catalog.

Technical data valid for copper conductors only.

1SNK16402850201

# ZDK2.5-D1 PI-Spring pluggable terminal blocks

## Double deck feed-through 1 circuit - 5.2 mm 0.205 in spacing

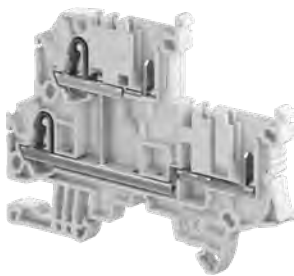

1SNK16425V0014

ZDK2.5-D1

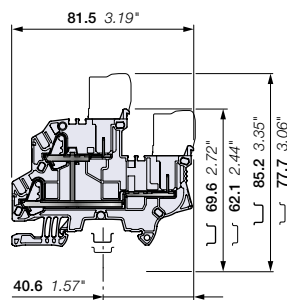

5.2 mm 0.205 in spacing

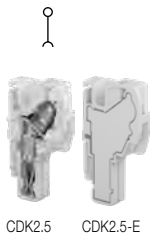

CDK2.5 CDK2.5-E

### Description

- Increase your productivity with pluggable terminal blocks: possibility of pre-produced plugs harnesses, time saving plug and play assembly, reduced transportation panels preparation and final installation, easily connect sub-assemblies together,
- Simplify and secure your installation: in site faulty connection errors are eliminated, prior connection testing is eased and reliable, test connectors (TC5) withstanding 10 000 operations are compatible for convenient testing.

### Ordering details

Description	Color	Type	Part Number	Pkg qty	Weight (1 pce) g
Feed-through double deck 4 connections	Grey	ZDK2.5-D1	1SNK805214R0000	50	12.46

### Main technical data

Connecting capacity	IEC	UL - CSA	Rail	TH 35-7.5, TH 35-15
1 conductor per clamp	Rigid: Solid/Stranded	0.2 ... 4 mm <sup>2</sup>	26 ... 12 AWG	11 mm 0.433 in
	Flexible without ferrule	0.22 ... 2.5 mm <sup>2</sup>	26 ... 14 AWG	
	Flexible with non insulated ferrule	0.22 ... 2.5 mm <sup>2</sup>	26 ... 14 AWG	
	Flexible with insulated ferrule	0.22 ... 2.5 mm <sup>2</sup>	26 ... 14 AWG	
2 conductors per clamp	Flexible with twin ferrule	0.22 ... 0.5 mm <sup>2</sup>	26 ... 20 AWG	Flat screwdriver Ø 3.5 mm Ø 0.138 in
Rated current / Rated cross section	22 A / 2.5 mm <sup>2</sup>	20 A / 12 AWG		
Rated short-time withstand current (1s)	300 A			
Rated voltage	800 V	600 V		
Impulse withstand voltage	8000 V			
Protection	IP20	NEMA 1		

The connecting capacity data for one Rigid: Solid/Stranded, or one Flexible conductor (when applicable) is a mandatory information required by IEC, UL and CSA standards (Copper conductors). All other data are provided as supplementary information only. For more details, please consult our CB, UL or CSA certificates and technical datasheet available on <http://www.TE.com>

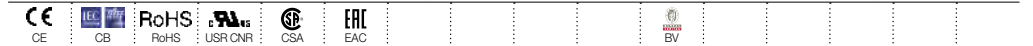

### Female plugs

Description	Color	Type	Part Number	Pkg qty	Weight (1 pce) g
Female plugs 1 pole	Grey	CDK2.5	1SNK805712R0000	50	2.80
Female plugs without outer nubs - Closed 15 poles max.		CDK2.5-E	1SNK805713R0000	50	2.88

### Accessories

Description	Color	Type	Part Number	Pkg qty	Weight (1 pce) g	
1 End stops 5.2 mm 0.205 in	Dark grey	BAZ1	1SNK900002R0000	50	5.30	
2 End sections 2.0 mm 0.079 in	Dark grey	EDK2.5-D	1SNK805913R0000	20	3.88	
3 Jumper bars 2 poles 32 A (IEC)	Orange	JB5-2	1SNK905302R0000	50	1.30	
		3 poles 32 A (IEC)	JB5-3	1SNK905303R0000	50	2.00
		4 poles 32 A (IEC)	JB5-4	1SNK905304R0000	50	2.70
		5 poles 32 A (IEC)	JB5-5	1SNK905305R0000	50	3.50
		10 poles 32 A (IEC)	JB5-10	1SNK905310R0000	30	7.10
		50 poles 32 A (IEC)	JB5-50	1SNK905350R0000	10	36.00
4 Cross spacing jumpers 3 poles 32 A (IEC)	Orange	JB85-3	1SNK900603R0000	10	2.80	
5 Test adapters For test plugs DIA 2 mm 0.079 in For test plugs DIA 4 mm 0.157 in	Dark grey	TP2	1SNK900203R0000	20	1.70	
		TP4	1SNK900205R0000	20	2.40	
6 Test connectors 5.2 mm 0.205 in spacing End module, 5.2 mm 0.205 in	Dark grey	TC5	1SNK900200R0000	10	5.20	
		TC5-R1	1SNK900201R0000	10	5.20	
7 Coding pegs	Dark grey	COP-ZD	1SNK900636R0000	10	3.57	
		MC512	1SNK140000R0000	22	9.00	
		MC512PA	1SNK149999R0000	20	10.00	
8 Terminal block markers	White	MG-CPM 13 41790	1SNB041790R0512	1960	0.236	
		Universal wire markers holder	Grey	UMH	1SNK900611R0000	10

Complete list of accessories is indicated in the terminal block datasheet including end stops. Some accessories such as jumper bars may modify the terminal block's ratings: Complete information available in the accessories section of the catalog.

Technical data valid for copper conductors only.



# ZDK2.5-D2-PE PI-Spring pluggable terminal blocks

## Double deck feed-through + ground - 5.2 mm 0.205 in spacing

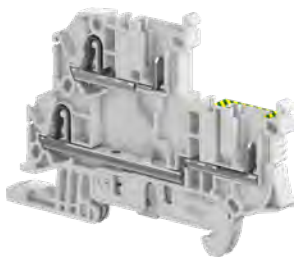

1SNK1640Z7V0014

ZDK2.5-D2-PE

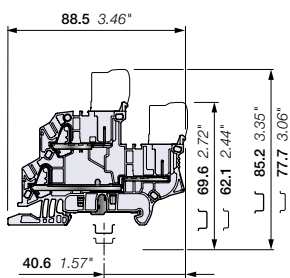

5.2 mm 0.205 in spacing

### Description

- Increase your productivity with pluggable terminal blocks: possibility of pre-produced plugs harnesses, time saving plug and play assembly, reduced transportation panels preparation and final installation, easily connect sub-assemblies together,
- Simplify and secure your installation: in site faulty connection errors are eliminated, prior connection testing is eased and reliable, test connectors (TC5) withstanding 10 000 operations are compatible for convenient testing.

### Ordering details

Description	Color	Type	Part Number	Pkg qty	Weight (1 pce) g	
Feed-through + ground	double deck 4 connections	Grey, Green-yellow	ZDK2.5-D2-PE	1SNK805212R0000	50	16.13

### Main technical data

Connecting capacity	IEC	UL - CSA
1 conductor per clamp	Rigid: Solid/Stranded	26 ... 12 AWG
	Flexible without ferrule	0.22 ... 2.5 mm <sup>2</sup>
	Flexible with non insulated ferrule	26 ... 14 AWG
	Flexible with insulated ferrule	26 ... 14 AWG
2 conductors per clamp	Flexible with twin ferrule	26 ... 20 AWG
		0.22 ... 0.5 mm <sup>2</sup>
Rated current / Rated cross section	22 A / 2.5 mm <sup>2</sup>	20 A / 12 AWG
Rated short-time withstand current (1s)	300 A	396 A
Rated voltage	800 V	600 V
Impulse withstand voltage	8000 V	
Protection	IP20	NEMA 1

### Mounting instructions

Mounting instructions	Diagram	Dimensions
Rail		TH 35-7.5, TH 35-15
Wire stripping length		11 mm 0.433 in
Tool (for flexible conductor without ferrule)		Flat screwdriver Ø 3.5 mm Ø 0.138 in

The connecting capacity data for one Rigid: Solid/Stranded, or one Flexible conductor (when applicable) is a mandatory information required by IEC, UL and CSA standards (Copper conductors). All other data are provided as supplementary information only. For more details, please consult our CB, UL or CSA certificates and technical datasheet available on <http://www.TE.com>

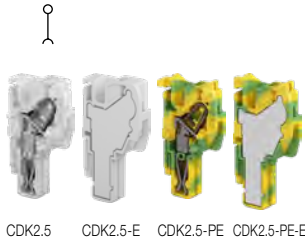
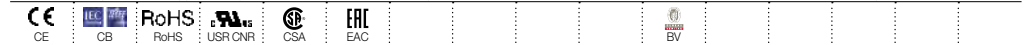

CDK2.5 CDK2.5-E CDK2.5-PE CDK2.5-PE-E

### Female plugs

Description	Color	Type	Part Number	Pkg qty	Weight (1 pce) g	
Female plugs	1 pole	Grey	CDK2.5	1SNK805712R0000	50	2.80
Female plugs without outer nubs - Closed	1 pole		CDK2.5-E	1SNK805713R0000	50	2.88
Female plugs	1 pole	Green-yellow	CDK2.5-PE	1SNK805750R0000	50	2.80
Female plugs without outer nubs - Closed	1 pole		CDK2.5-PE-E	1SNK805753R0000	50	2.88

15 poles max.

### Accessories



Description	Color	Type	Part Number	Pkg qty	Weight (1 pce) g	
1 End stops	5.2 mm 0.205 in	Dark grey	BAZ1	1SNK900002R0000	50	5.30
2 End sections	2.0 mm 0.079 in	Dark grey	EDK2.5-D	1SNK805913R0000	20	3.88
3 Jumper bars	2 poles	32 A (IEC)	JB5-2	1SNK905302R0000	50	1.30
	3 poles	32 A (IEC)	JB5-3	1SNK905303R0000	50	2.00
	4 poles	32 A (IEC)	JB5-4	1SNK905304R0000	50	2.70
	5 poles	32 A (IEC)	JB5-5	1SNK905305R0000	50	3.50
	10 poles	32 A (IEC)	JB5-10	1SNK905310R0000	30	7.10
	50 poles	32 A (IEC)	JB5-50	1SNK905350R0000	10	36.00
4 Cross spacing jumpers	3 poles	32 A (IEC)	JB85-3	1SNK900603R0000	10	2.80
5 Test adapters	For test plugs DIA 2 mm 0.079 in	Dark grey	TP2	1SNK900203R0000	20	1.70
	For test plugs DIA 4 mm 0.157 in		TP4	1SNK900205R0000	20	2.40
6 Test connectors	5.2 mm 0.205 in spacing	Dark grey	TC5	1SNK900200R0000	10	5.20
	End module, 5.2 mm 0.205 in		TC5-R1	1SNK900201R0000	10	5.20
7 Coding pegs		Dark grey	COP-ZD	1SNK900636R0000	10	3.57
		White	MC512	1SNK140000R0000	22	9.00
			MC512PA	1SNK149999R0000	20	10.00
8 Terminal block markers	Blank card		MG-CPM 13 41790	1SNB041790R0512	1960	0.236
	Blank marker		UMH	1SNK900611R0000	10	0.20

Complete list of accessories is indicated in the terminal block datasheet including end stops.

Some accessories such as jumper bars may modify the terminal block's ratings: Complete information available in the accessories section of the catalog.

Technical data valid for copper conductors only.

1SNK1640Z7V0014



# ZDK2.5-D1-PE PI-Spring pluggable terminal blocks

Double deck ground - 5.2 mm 0.205 in spacing

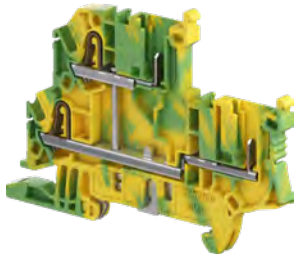

1SNK16402B0004

ZDK2.5-D1-PE

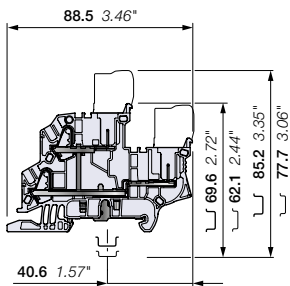

5.2 mm 0.205 in spacing



CDK2.5-PE CDK2.5-PE-E



## Description

- Increase your productivity with pluggable terminal blocks: possibility of pre-produced plugs harnesses, time saving plug and play assembly, reduced transportation panels preparation and final installation, easily connect sub-assemblies together,
- Simplify and secure your installation: in site faulty connection errors are eliminated, prior connection testing is eased and reliable, test connectors (TC5) withstanding 10 000 operations are compatible for convenient testing.

## Ordering details

Description	Color	Type	Part Number	Pkg qty	Weight (1 pce) g
Ground double deck 4 connections	Green-yellow	ZDK2.5-D1-PE	1SNK805250R0000	50	16.80

## Main technical data

Connecting capacity	IEC	UL - CSA	Mounting instructions		
1 conductor per clamp	Rigid: Solid/Stranded	0.2 ... 4 mm <sup>2</sup>	26 ... 12 AWG	Rail	TH 35-7.5, TH 35-15
	Flexible without ferrule	0.22 ... 2.5 mm <sup>2</sup>	26 ... 14 AWG	Wire stripping length	11 mm 0.433 in
	Flexible with non insulated ferrule	0.22 ... 2.5 mm <sup>2</sup>	26 ... 14 AWG		Tool (for flexible conductor without ferrule)
	Flexible with insulated ferrule	0.22 ... 2.5 mm <sup>2</sup>	26 ... 14 AWG		
Rated cross section	2.5 mm <sup>2</sup>	12 AWG			
Rated short-time withstand current (1s)	300 A	396 A			
Protection	IP20	NEMA 1			

The connecting capacity data for one Rigid: Solid/Stranded, or one Flexible conductor (when applicable) is a mandatory information required by IEC, UL and CSA standards (Copper conductors). All other data are provided as supplementary information only. For more details, please consult our CB, UL or CSA certificates and technical datasheet available on <http://www.TE.com>

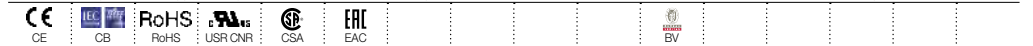

## Female plugs

Description	Color	Type	Part Number	Pkg qty	Weight (1 pce) g
Female plugs 1 pole	Green-yellow	CDK2.5-PE	1SNK805750R0000	50	2.80
Female plugs without outer nubs - Closed 15 poles max.		CDK2.5-PE-E	1SNK805753R0000	50	2.88

## Accessories

Description	Color	Type	Part Number	Pkg qty	Weight (1 pce) g	
1 End stops 5.2 mm 0.205 in	Dark grey	BAZ1	1SNK900002R0000	50	5.30	
2 End sections 2.0 mm 0.079 in	Dark grey	EDK2.5-D	1SNK805913R0000	20	3.88	
3 Test adapters	Dark grey	For test plugs DIA 2 mm 0.079 in	TP2	1SNK900203R0000	20	1.70
		For test plugs DIA 4 mm 0.157 in	TP4	1SNK900205R0000	20	2.40
4 Test connectors 5.2 mm 0.205 in spacing	Dark grey	End module, 5.2 mm 0.205 in	TC5	1SNK900200R0000	10	5.20
			TC5-R1	1SNK900201R0000	10	5.20
5 Coding pegs	Dark grey	COP-ZD	1SNK900636R0000	10	3.57	
6 Terminal block markers	White	MC512	1SNK140000R0000	22	9.00	
	Grey	UMH	1SNK149999R0000	20	10.00	
	Grey	UMH	1SNK900611R0000	10	0.20	

Complete list of accessories is indicated in the terminal block datasheet including end stops. Some accessories such as jumper bars may modify the terminal block's ratings: Complete information available in the accessories section of the catalog.

Technical data valid for copper conductors only.

# CDK2.5 PI-Spring female plugs

## Female plug - 5.2 mm 0.205 in spacing

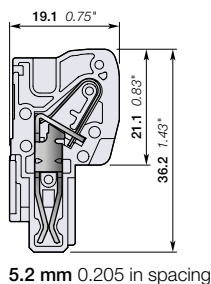
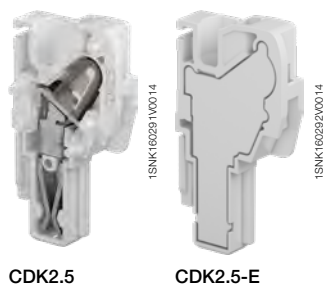

### Description

- Create your own female plug assemblies without any special tools, easily snap together multiple plugs for optimal ergonomics and quick assembly,
- Increase your flexibility: eliminate stock of pre-configured female plugs, easily add an extra plug in case of needed modification,
- Reduce your stock of unitary plugs up to 30%: only two plug variants are required to compose your own subsets of plugs from 2 to 15 poles.

### Ordering details

Description	Color	Type	Part number	Pkg qty	Weight (1 pce) g
Female plugs	Grey	CDK2.5	1SNK805712R0000	50	2.80
	Blue	CDK2.5-BL	1SNK805742R0000	50	2.80
	Green-Yellow	CDK2.5-PE	1SNK805750R0000	50	2.80
Female plugs without outer nubs - Closed	Grey	CDK2.5-E	1SNK805713R0000	50	2.80
	Blue	CDK2.5-BL-E	1SNK805743R0000	50	2.80
	Green-Yellow	CDK2.5-PE-E	1SNK805753R0000	50	2.80

### Main technical data

Connecting capacity		IEC	UL - CSA	Mounting instructions	
1 conductor per clamp	Rigid: Solid/Stranded	0.2 ... 4 mm²	26 ... 12 AWG	Rail	
	Flexible without ferrule	0.22 ... 2.5 mm²		Wire stripping length	11 mm 0.433 in
	Flexible with non insulated ferrule	0.22 ... 2.5 mm²	26 ... 14 AWG	Tool (for flexible conductor without ferrule)	Flat screwdriver Ø 3.5 mm Ø 0.138 in
	Flexible with insulated ferrule	0.22 ... 2.5 mm²	26 ... 14 AWG		
2 conductors per clamp	Flexible with twin ferrule	0.22 ... 0.5 mm²	26 ... 20 AWG		
Rated current / Rated cross section		24 A / 2.5 mm²	22 A / 12 AWG		
Rated short-time withstand current (1s)		300 A			
Rated voltage		1000 V	600 V		
Impulse withstand voltage		8000 V			
Protection		IP20	NEMA 1		

The connecting capacity data for one Rigid: Solid/Stranded, or one Flexible conductor (when applicable) is a mandatory information required by IEC, UL and CSA standards (Copper conductors). All other data are provided as supplementary information only. For more details, please consult our CB, UL or CSA certificates and technical datasheet available on <http://www.TE.com>

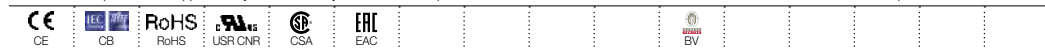

### Mounting instructions



15 poles max.



### Accessories

Description	Color	Type	Part number	Pkg qty	Weight (1 pce) g
1 Locking devices	Black	VR-ZD	1SNK900637R0000	50	0.7
2 Cable clamp	Dark grey	PT-ZD	1SNK900660R0000	50	1.04
3 Terminal block markers	White	MG-CPM 13 41790	1SNB041790R0512	1960	0.23
		MG-CPMFA 43196	1SNB043196R0012	350	2.56
		MC512	1SNK140000R0000	22	9.00
		MC512PA	1SNK149999R0000	20	10.00
	Universal wire markers holder	Grey	UMH	1SNK900611R0000	10

Complete list of accessories is indicated in the terminal block datasheet including end stops. Some accessories such as jumper bars may modify the terminal block's ratings: Complete information available in the accessories section of the catalog.

Technical data valid for copper conductors only.

1SNK164005S0201

# CDK2.5-J PI-Spring female plugs

## Female plug - 5.2 mm 0.205 in spacing

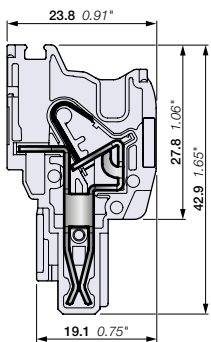
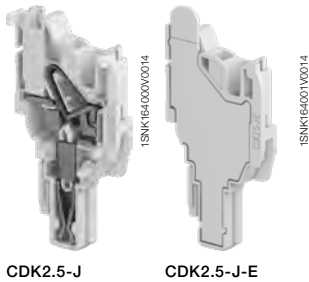

5.2 mm 0.205 in spacing

### Description

- Create your own female plug assemblies without any special tools, easily snap together multiple plugs for optimal ergonomics and quick assembly,
- Increase your flexibility: eliminate stock of pre-configured female plugs, easily add an extra plug in case of needed modification,
- Reduce your stock of unitary plugs up to 30%: only two plug variants are required to compose your own subsets of plugs from 2 to 15 poles.

Description	Color	Type	Part Number	Pkg qty	Weight (1 pce)
Female plugs	Grey	CDK2.5-J	1SNK805738R0000	50	4.08
	Blue	CDK2.5-J-BL	1SNK805744R0000	50	4.08
	Green-yellow	CDK2.5-J-PE	1SNK805748R0000	50	4.08
Female plugs without outer nubs - Closed	Grey	CDK2.5-J-E	1SNK805739R0000	50	4.34
	Blue	CDK2.5-J-BL-E	1SNK805745R0000	50	4.34
	Green-yellow	CDK2.5-J-PE-E	1SNK805749R0000	50	4.34

### Main technical data

Connecting capacity	IEC	UL - CSA	Mounting instructions
1 conductor per clamp	Rigid: Solid/Stranded	0.2 ... 4 mm²	Rail Wire stripping length  11 mm / 0.433 in
	Flexible without ferrule	0.22 ... 2.5 mm²	
	Flexible with non insulated ferrule	0.22 ... 2.5 mm²	
	Flexible with insulated ferrule	0.22 ... 2.5 mm²	
2 conductors per clamp	Flexible with twin ferrule	0.22 ... 0.5 mm²	Tool (for flexible conductor without ferrule)  Flat screwdriver Ø 3.5 mm / Ø 0.138 in
Rated current / Rated cross section	24 A / 2.5 mm²	20 A / 12 AWG	
Rated short-time withstand current (1s)	300 A		
Rated voltage	800 V	600 V	
Impulse withstand voltage	8000 V		
Protection	IP20	NEMA 1	

The connecting capacity data for one Rigid: Solid/Stranded, or one Flexible conductor (when applicable) is a mandatory information required by IEC, UL and CSA standards (Copper conductors). All other data are provided as supplementary information only. For more details, please consult our CB, UL or CSA certificates and technical datasheet available on <http://www.TE.com>



### Mounting instructions



### Accessories

Description	Color	Type	Part Number	Pkg qty	Weight (1 pce)
1 Jumper bars	Orange	2 poles 32 A (IEC)	JB5-2	1SNK905302R0000	50 / 1.30
		3 poles 32 A (IEC)	JB5-3	1SNK905303R0000	50 / 2.00
		4 poles 32 A (IEC)	JB5-4	1SNK905304R0000	50 / 2.70
		5 poles 32 A (IEC)	JB5-5	1SNK905305R0000	50 / 3.50
		10 poles 32 A (IEC)	JB5-10	1SNK905310R0000	30 / 7.10
		50 poles 32 A (IEC)	JB5-50	1SNK905350R0000	10 / 36.00
2 Test adapters	Dark grey	For test plugs DIA 2 mm 0.079 in	TP2	1SNK900203R0000	20 / 1.70
		For test plugs DIA 4 mm 0.157 in	TP4	1SNK900205R0000	20 / 2.40
3 Test connectors	Dark grey	5.2 mm 0.205 in spacing	TC5	1SNK900200R0000	10 / 5.20
		End module, 5.2 mm 0.205 in	TC5-R1	1SNK900201R0000	10 / 5.20
4 Locking devices	Black	VR-ZD	1SNK900637R0000	50 / 0.7	
5 Strain Relief	Dark grey	PT-ZD	1SNK900660R0000	50 / 1.04	
6 Terminal block markers	White	Blank card	MC512	1SNK140000R0000	22 / 9.00
			MC512PA	1SNK149999R0000	20 / 10.00
	Blank strip label	MG-CPMFA 43196	1SNB043196R0012	400 / 2.562	
	Blank marker	MG-CPM 13 41790	1SNB041790R0512	1960 / 0.236	
	Grey	UMH	1SNK900611R0000	10 / 0.20	

Complete list of accessories is indicated in the terminal block datasheet including end stops.

Some accessories such as jumper bars may modify the terminal block's ratings: Complete information available in the accessories section of the catalog.

Technical data valid for copper conductors only.

# CDK2.5-2P-J PI-Spring female plugs

## Female plug - 5.2 mm 0.205 in spacing

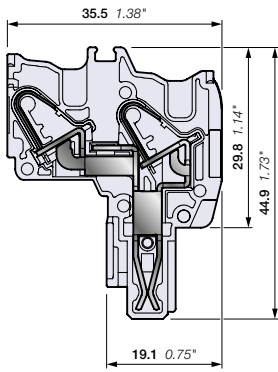
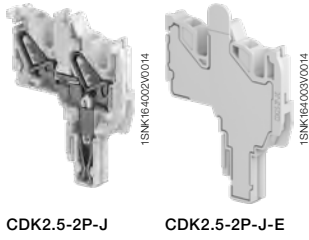

5.2 mm 0.205 in spacing

### Description

- Create your own female plug assemblies without any special tools, easily snap together multiple plugs for optimal ergonomics and quick assembly,
- Increase your flexibility: eliminate stock of pre-configured female plugs, easily add an extra plug in case of needed modification,
- Reduce your stock of unitary plugs up to 30%: only two plug variants are required to compose your own subsets of plugs from 2 to 15 poles.

Description	Color	Type	Part Number	Pkg qty	Weight (1 pce) g
Female plugs	Grey	<input type="checkbox"/> CDK2.5-2P-J	1SNK805740R0000	50	5.37
	Blue	<input type="checkbox"/> CDK2.5-2P-J-BL	1SNK805746R0000	50	5.37
	Green-yellow	<input type="checkbox"/> CDK2.5-2P-J-PE	1SNK805751R0000	50	5.37
Female plugs without outer nubs - Closed	Grey	<input type="checkbox"/> CDK2.5-2P-J-E	1SNK805741R0000	50	5.74
	Blue	<input type="checkbox"/> CDK2.5-2P-J-BL-E	1SNK805747R0000	50	5.74
	Green-yellow	<input type="checkbox"/> CDK2.5-2P-J-PE-E	1SNK805752R0000	50	5.74

### Main technical data

Connecting capacity	IEC	UL - CSA	Rail			
1 conductor per clamp	Rigid: Solid/Stranded	0.2 ... 4 mm²	26 ... 12 AWG	Wire stripping length		11 mm 0.433 in
	Flexible without ferrule	0.22 ... 2.5 mm²				
	Flexible with non insulated ferrule	0.22 ... 2.5 mm²	26 ... 14 AWG			
	Flexible with insulated ferrule	0.22 ... 2.5 mm²	26 ... 14 AWG			
2 conductors per clamp	Flexible with twin ferrule	0.22 ... 0.5 mm²	26 ... 20 AWG	Tool (for flexible conductor without ferrule)		Flat screwdriver Ø 3.5 mm Ø 0.138 in
Rated current / Rated cross section	24 A / 2.5 mm²	20 A / 12 AWG				
Rated short-time withstand current (1s)	300 A					
Rated voltage	500 V	600 V				
Impulse withstand voltage	6000 V					
Protection	IP20	NEMA 1				

The connecting capacity data for one Rigid: Solid/Stranded, or one Flexible conductor (when applicable) is a mandatory information required by IEC, UL and CSA standards (Copper conductors). All other data are provided as supplementary information only. For more details, please consult our CB, UL or CSA certificates and technical datasheet available on <http://www.TE.com>



### Mounting instructions

### Mounting instructions



### Accessories



Description	Color	Type	Part Number	Pkg qty	Weight (1 pce) g	
1 Jumper bars	Orange	2 poles 32 A (IEC)	JB5-2	1SNK905302R0000	50	1.30
		3 poles 32 A (IEC)	JB5-3	1SNK905303R0000	50	2.00
		4 poles 32 A (IEC)	JB5-4	1SNK905304R0000	50	2.70
		5 poles 32 A (IEC)	JB5-5	1SNK905305R0000	50	3.50
		10 poles 32 A (IEC)	JB5-10	1SNK905310R0000	30	7.10
		50 poles 32 A (IEC)	JB5-50	1SNK905350R0000	10	36.00
2 Test adapters	Dark grey	For test plugs DIA 2 mm 0.079 in	TP2	1SNK900203R0000	20	1.70
		For test plugs DIA 4 mm 0.157 in	TP4	1SNK900205R0000	20	2.40
3 Test connectors	Dark grey	5.2 mm 0.205 in spacing	TC5	1SNK900200R0000	10	5.20
		End module, 5.2 mm 0.205 in	TC5-R1	1SNK900201R0000	10	5.20
4 Locking devices	Black	VR-ZD	1SNK900637R0000	50	0.7	
5 Strain Relief	Dark grey	PT-ZD	1SNK900660R0000	50	1.04	
6 Terminal block markers	White	MC512	1SNK140000R0000	22	9.00	
		MC512PA	1SNK149999R0000	20	10.00	
	Blank strip label	MG-CPMFA 43196	1SNB043196R0012	400	2.562	
	Blank marker	MG-CPM 13 41790	1SNB041790R0512	1960	0.236	
	Universal wire markers holder	Grey	UMH	1SNK900611R0000	10	0.20

Complete list of accessories is indicated in the terminal block datasheet including end stops.

Some accessories such as jumper bars may modify the terminal block's ratings: Complete information available in the accessories section of the catalog.

Technical data valid for copper conductors only.

1SNK1640350201

# CDK4 PI-Spring female plugs

## Female plug - 6 mm 0.236 in spacing

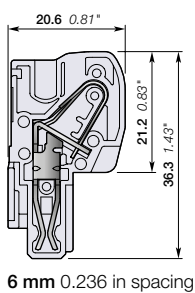
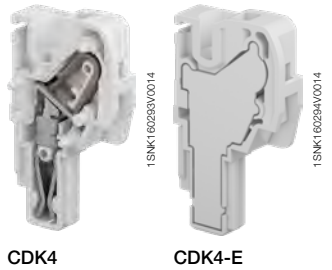

### Description

- Create your own female plug assemblies without any special tools, easily snap together multiple plugs for optimal ergonomics and quick assembly,
- Increase your flexibility: eliminate stock of pre-configured female plugs, easily add an extra plug in case of needed modification,
- Reduce your stock of unitary plugs up to 30%: only two plug variants are required to compose your own subsets of plugs from 2 to 15 poles.

### Ordering details

Description	Color	Type	Part Number	Pkg qty	Weight (1 pce) g
Female plugs	Grey <input type="checkbox"/>	CDK4	1SNK806712R0000	50	3.80
Female plugs without outer nubs - Closed		CDK4-E	1SNK806713R0000	50	4.50

### Main technical data

Connecting capacity		IEC	UL - CSA	Mounting instructions	
1 conductor per clamp	Rigid: Solid/Stranded	0.5 ... 6 mm <sup>2</sup>	26 ... 10 AWG	Wire stripping length	12.5 mm 0.492 in
	Flexible without ferrule	0.5 ... 4 mm <sup>2</sup>			
	Flexible with non insulated ferrule	0.5 ... 4 mm <sup>2</sup>	26 ... 12 AWG	Tool (for flexible conductor without ferrule)	Flat screwdriver Ø 3.5 mm Ø 0.138 in
	Flexible with insulated ferrule	0.5 ... 4 mm <sup>2</sup>	26 ... 12 AWG		
2 conductors per clamp	Flexible with twin ferrule	0.5 ... 1 mm <sup>2</sup>	26 ... 18 AWG		
Rated current / Rated cross section		30 A / 4 mm <sup>2</sup>	30 A / 10 AWG		
Rated short-time withstand current (1s)		480 A			
Rated voltage		1000 V	600 V		
Impulse withstand voltage		8000 V			
Protection		IP20	NEMA 1		

The connecting capacity data for one Rigid: Solid/Stranded, or one Flexible conductor (when applicable) is a mandatory information required by IEC, UL and CSA standards (Copper conductors). All other data are provided as supplementary information only. For more details, please consult our CB, UL or CSA certificates and technical datasheet available on <http://www.TE.com>

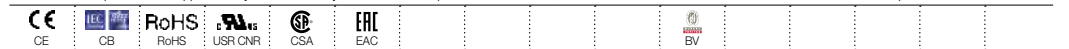

### Mounting instructions



### Accessories

Description	Color	Type	Part Number	Pkg qty	Weight (1 pce) g
1 Locking devices 9.4 mm 0.370 in spacing	Black <input checked="" type="checkbox"/>	VR-ZD	1SNK900637R0000	50	0.7
2 Cable Clamp 9.4 mm 0.370 in spacing	Dark grey <input checked="" type="checkbox"/>	PT-ZD	1SNK900660R0000	50	1.04
3 Terminal block markers	White <input type="checkbox"/>	MG-CPM 13 41791	1SNB041791R0612	1680	0.27
		MG-CPMFA 43196	1SNB043196R0012	350	2.56
		MC612	1SNK150000R0000	22	10.00
		MC612PA	1SNK159999R0000	20	11.00
	Universal wire markers holder	Grey <input type="checkbox"/>	UMH	1SNK900611R0000	10

Complete list of accessories is indicated in the terminal block datasheet including end stops. Some accessories such as jumper bars may modify the terminal block's ratings: Complete information available in the accessories section of the catalog.

Technical data valid for copper conductors only.



## Screw clamp Pluggable

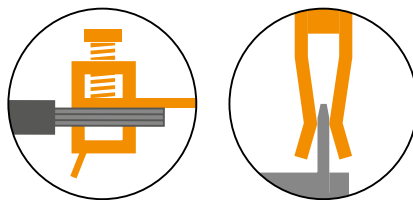

# ZDS4-22 Screw clamp pluggable terminal blocks

Feed-through - 5.2 mm 0.205 in spacing

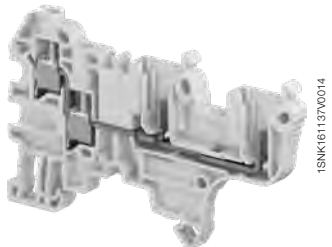

ZDS4-22

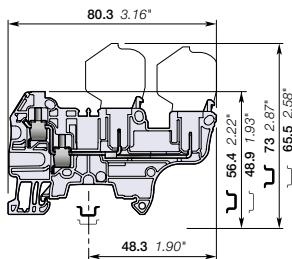

5.2 mm 0.205 in spacing

## Description

- Increase your productivity with pluggable terminal blocks: possibility of pre-produced plugs harnesses, time saving plug and play assembly, reduced transportation panels preparation and final installation, easily connect sub-assemblies together,
- Simplify and secure your installation: in site faulty connection errors are eliminated, prior connection testing is eased and reliable, test connectors (TC5) withstanding 10 000 operations are compatible for convenient testing.

## Ordering details

Description	Color	Type	Part Number	Pkg qty	Weight (1 pce) g
Feed-through 4 connections	Grey <input type="checkbox"/>	ZDS4-22	1SNK805013R0000	50	10.80

## Main technical data

Connecting capacity		IEC	UL - CSA
1 conductor per clamp	Rigid: Solid/Stranded	0.2 ... 4 mm <sup>2</sup>	24 ... 10 AWG
	Flexible without ferrule	0.22 ... 4 mm <sup>2</sup>	24 ... 10 AWG
	Flexible with non insulated ferrule	0.22 ... 4 mm <sup>2</sup>	24 ... 10 AWG
	Flexible with insulated ferrule	0.22 ... 2.5 mm <sup>2</sup>	24 ... 12 AWG
	Gauge	A3-B3	
2 conductors per clamp	Rigid: Solid/Stranded	0.2 ... 1.5 mm <sup>2</sup>	24 ... 16 AWG
	Flexible without ferrule	0.22 ... 1.5 mm <sup>2</sup>	24 ... 16 AWG
	Flexible with twin ferrule	0.22 ... 1.5 mm <sup>2</sup>	24 ... 16 AWG
Rated current / Rated cross section		29 A / 4 mm <sup>2</sup>	28 A / 10 AWG
Rated short-time withstand current (1s)		480 A	
Rated voltage		800 V	300 V
Impulse withstand voltage		8000 V	
Protection		IP20	NEMA 1

## Mounting instructions

Rail		TH 35-7.5, TH 35-15
Wire stripping length		10.5 mm 0.413 in
Tool		Flat screwdriver Ø 3.5 mm Ø 0.138 in
Torque		0.6 Nm ± 0.1 5.31 lb.in ± 0.885

The connecting capacity data for one Rigid: Solid/Stranded, or one Flexible conductor (when applicable) is a mandatory information required by IEC, UL and CSA standards (Copper conductors). All other data are provided as supplementary information only. For more details, please consult our CB, UL or CSA certificates and technical datasheet available on <http://www.TE.com>

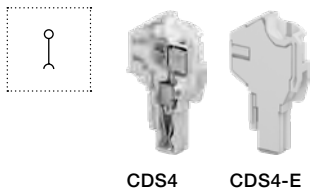
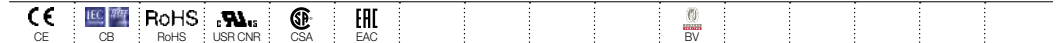

CDS4 CDS4-E

## Female plugs

Description	Color	Type	Part Number	Pkg qty	Weight (1 pce) g
Female plugs 1 pole	Grey <input type="checkbox"/>	CDS4	1SNK805714R0000	50	3.90
Female plugs without outer nubs - Closed		CDS4-E	1SNK805715R0000	50	4.10

15 poles max.

## Accessories



Description	Color	Type	Part Number	Pkg qty	Weight (1 pce) g	
1 End stops 10 mm 0.394 in	Dark grey <input type="checkbox"/>	BAM4	1SNK900001R0000	50	14.00	
2 End sections 0.8 mm 0.031 in	Dark grey <input type="checkbox"/>	EDS4-22	1SNK805911R0000	20	1.85	
3 Jumper bars	Orange <input type="checkbox"/>	2 poles 32 A (IEC)	JB5-2	1SNK905302R0000	50	1.30
		3 poles 32 A (IEC)	JB5-3	1SNK905303R0000	50	2.00
		4 poles 32 A (IEC)	JB5-4	1SNK905304R0000	50	2.70
		5 poles 32 A (IEC)	JB5-5	1SNK905305R0000	50	3.50
		10 poles 32 A (IEC)	JB5-10	1SNK905310R0000	30	7.10
50 poles 32 A (IEC)		JB5-50	1SNK905350R0000	10	36.00	
4 Circuit separators 3 mm 0.118 in	Dark grey <input type="checkbox"/>	CS-R3	1SNK900107R0000	20	6.40	
5 Test adapters	Dark grey <input type="checkbox"/>	For test plugs DIA 2 mm 0.079 in	TP2	1SNK900203R0000	20	1.70
		For test plugs DIA 4 mm 0.157 in	TP4	1SNK900205R0000	20	2.40
6 Test connectors	Dark grey <input type="checkbox"/>	5.2 mm 0.205 in spacing	TC5	1SNK900200R0000	10	5.20
		End module, 5.2 mm 0.205 in	TC5-R1	1SNK900201R0000	10	5.20
7 Coding pegs	Dark grey <input type="checkbox"/>	COP-ZD	1SNK900636R0000	10	3.57	
8 Terminal block markers	White <input type="checkbox"/>	Blank marker	MG-CPM 13 41790	1SNB041790R0512	1960	0.23
		Blank card	MC512	1SNK140000R0000	22	9.00
			MC512PA	1SNK149999R0000	20	10.00
Universal wire markers holder	Grey <input type="checkbox"/>	UMH	1SNK900611R0000	10	0.20	

Complete list of accessories is indicated in the terminal block datasheet including end stops. Some accessories such as jumper bars may modify the terminal block's ratings: Complete information available in the accessories section of the catalog.

Technical data valid for copper conductors only.

# CDS4 Screw clamp female plugs

## Female plug - 5.2 mm 0.205 in spacing

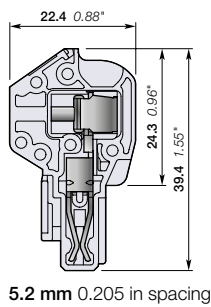
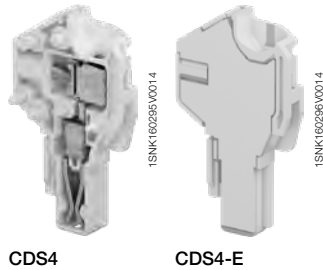
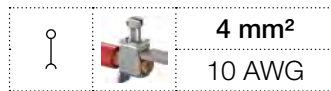

### Description

- Create your own female plug assemblies without any special tools, easily snap together multiple plugs for optimal ergonomics and quick assembly,
- Increase your flexibility: eliminate stock of pre-configured female plugs, easily add an extra plug in case of needed modification,
- Reduce your stock of unitary plugs up to 30%: only two plug variants are required to compose your own subsets of plugs from 2 to 15 poles.

### Ordering details

Description	Color	Type	Part Number	Pkg qty	Weight (1 pce) g
Female plugs	Grey <input type="checkbox"/>	CDS4	1SNK805714R0000	50	3.90
Female plugs without outer nubs - Closed		CDS4-E	1SNK805715R0000	50	4.10

### Main technical data

Connecting capacity		IEC	UL - CSA	Mounting instructions	
1 conductor per clamp	Rigid: Solid/Stranded	0.2 ... 4 mm <sup>2</sup>	24 ... 10 AWG	Rail	
	Flexible without ferrule	0.22 ... 4 mm <sup>2</sup>		Wire stripping length	10.5 mm 0.413 in
	Flexible with non insulated ferrule	0.22 ... 4 mm <sup>2</sup>	24 ... 10 AWG		
	Flexible with insulated ferrule	0.22 ... 2.5 mm <sup>2</sup>	24 ... 12 AWG		
	Gauge	A3-B3			
2 conductors per clamp	Rigid: Solid/Stranded	0.2 ... 1.5 mm <sup>2</sup>	24 ... 16 AWG	Tool	Flat screwdriver Ø 3.5 mm Ø 0.138 in
	Flexible without ferrule	0.22 ... 1.5 mm <sup>2</sup>			
	Flexible with twin ferrule	0.22 ... 1.5 mm <sup>2</sup>	24 ... 16 AWG		
Rated current / Rated cross section		29 A / 4 mm <sup>2</sup>	28 A / 10 AWG	Torque	0.6 Nm ± 0.1 5.31 lb.in ± 0.885
Rated short-time withstand current (1s)		480 A			
Rated voltage		800 V	300 V		
Impulse withstand voltage		8000 V			
Protection		IP20	NEMA 1		

The connecting capacity data for one Rigid: Solid/Stranded, or one Flexible conductor (when applicable) is a mandatory information required by IEC, UL and CSA standards (Copper conductors). All other data are provided as supplementary information only. For more details, please consult our CB, UL or CSA certificates and technical datasheet available on <http://www.TE.com>

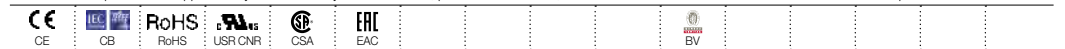

### Mounting instructions



### Accessories

Description	Color	Type	Part Number	Pkg qty	Weight (1 pce) g
1 Locking devices	Black <input checked="" type="checkbox"/>	VR-ZD	1SNK900637R0000	50	0.7
2 Cable Clamp	Dark grey <input checked="" type="checkbox"/>	PT-ZD	1SNK900660R0000	50	1.04
3 Terminal block markers	White <input type="checkbox"/>	MG-CPM 13 41790	1SNB041790R0512	1960	0.23
		MG-CPMFA 43196	1SNB043196R0012	350	2.56
		MC512	1SNK140000R0000	22	9.00
		MC512PA	1SNK149999R0000	20	10.00
	Universal wire markers holder	Grey <input type="checkbox"/>	UMH	1SNK900611R0000	10

Complete list of accessories is indicated in the terminal block datasheet including end stops. Some accessories such as jumper bars may modify the terminal block's ratings: Complete information available in the accessories section of the catalog.

Technical data valid for copper conductors only.

# ZDS4-22-R1 Screw clamp pluggable terminal blocks

Feed-through - 6 mm 0.236 in spacing

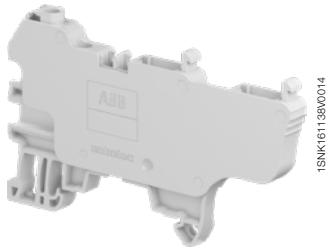

ZDS4-22-R1

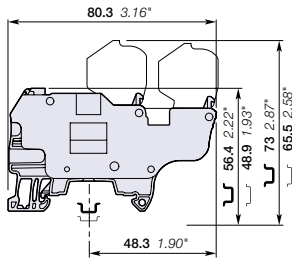

6 mm 0.236 in spacing

## Description

- Increase your productivity with pluggable terminal blocks: possibility of pre-produced plugs harnesses, time saving plug and play assembly, reduced transportation panels preparation and final installation, easily connect sub-assemblies together,
- Simplify and secure your installation: in site faulty connection errors are eliminated, prior connection testing is eased and reliable, test connectors (TC5-R1 + ES-TC6) withstanding 10 000 operations are compatible for convenient testing.

## Ordering details

Description	Color	Type	Part Number	Pkg qty	Weight (1 pce) g
Feed-through 4 connections	Grey <input type="checkbox"/>	ZDS4-22-R1	1SNK806013R0000	40	12.60

## Main technical data

Connecting capacity		IEC	UL - CSA
1 conductor per clamp	Rigid: Solid/Stranded	0.2 ... 4 mm²	24 ... 10 AWG
	Flexible without ferrule	0.22 ... 4 mm²	24 ... 10 AWG
	Flexible with non insulated ferrule	0.22 ... 4 mm²	24 ... 10 AWG
	Flexible with insulated ferrule	0.22 ... 4 mm²	24 ... 10 AWG
	Gauge	A3-B3	
2 conductors per clamp	Rigid: Solid/Stranded	0.2 ... 1.5 mm²	24 ... 16 AWG
	Flexible without ferrule	0.22 ... 1.5 mm²	24 ... 16 AWG
	Flexible with twin ferrule	0.22 ... 1.5 mm²	24 ... 16 AWG
Rated current / Rated cross section		29 A / 4 mm²	28 A / 10 AWG
Rated short-time withstand current (1s)		480 A	
Rated voltage		800 V	300 V
Impulse withstand voltage		8000 V	
Protection		IP20	NEMA 1

## Mounting instructions

Rail		TH 35-7.5, TH 35-15
Wire stripping length		10.5 mm 0.413 in
Tool		Flat screwdriver Ø 3.5 mm Ø 0.138 in
Torque		0.6 Nm ± 0.1 5.31 lb.in ± 0.885

The connecting capacity data for one Rigid: Solid/Stranded, or one Flexible conductor (when applicable) is a mandatory information required by IEC, UL and CSA standards (Copper conductors). All other data are provided as supplementary information only. For more details, please consult our CB, UL or CSA certificates and technical datasheet available on <http://www.TE.com>

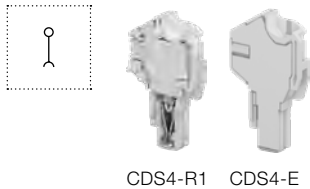
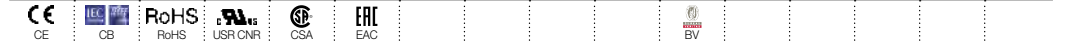

CDS4-R1 CDS4-E

## Female plugs

Description	Color	Type	Part Number	Pkg qty	Weight (1 pce) g
Female plugs 1 pole	Grey <input type="checkbox"/>	CDS4-R1	1SNK806714R0000	50	4.10
Female plugs without outer nubs - Closed		CDS4-E	1SNK805715R0000	50	4.10

15 poles max.

## Accessories

Description	Color	Type	Part Number	Pkg qty	Weight (1 pce) g	
1 End stops 10 mm 0.394 in	Dark grey <input type="checkbox"/>	BAM4	1SNK900001R0000	50	14.00	
2 Jumper bars	Orange <input type="checkbox"/>	2 poles 41 A (IEC)	JB6-2	1SNK906302R0000	50	1.30
		3 poles 41 A (IEC)	JB6-3	1SNK906303R0000	50	2.10
		4 poles 41 A (IEC)	JB6-4	1SNK906304R0000	50	2.90
		5 poles 41 A (IEC)	JB6-5	1SNK906305R0000	50	3.60
		10 poles 41 A (IEC)	JB6-10	1SNK906310R0000	20	7.40
		50 poles 41 A (IEC)	JB6-50	1SNK906350R0000	10	38.10
3 Circuit separators 3 mm 0.118 in	Dark grey <input type="checkbox"/>	CS-R3	1SNK900107R0000	20	6.40	
4 Test adapters	Dark grey <input type="checkbox"/>	TP2	1SNK900203R0000	20	1.70	
	Dark grey <input type="checkbox"/>	TP4	1SNK900205R0000	20	2.40	
5 Test connectors End module, 5.2 mm 0.205 in	Dark grey <input type="checkbox"/>	TC5-R1	1SNK900201R0000	10	5.20	
6 Spacers 0.8 mm 0.031 in	Dark grey <input type="checkbox"/>	ES-TC6	1SNK900105R0000	10	0.80	
7 Coding pegs	Dark grey <input type="checkbox"/>	COP-ZD	1SNK900636R0000	10	3.57	
8 Terminal block markers	White <input type="checkbox"/>	Blank marker	MG-CPM 13 41791	1SNB041791R0612	1680	0.27
		Blank card	MC612	1SNK150000R0000	22	10.00
			MC612PA	1SNK159999R0000	20	11.00
		Universal wire markers holder	Grey <input type="checkbox"/>	UMH	1SNK900611R0000	10

Complete list of accessories is indicated in the terminal block datasheet including end stops.

Some accessories such as jumper bars may modify the terminal block's ratings: Complete information available in the accessories section of the catalog.

Technical data valid for copper conductors only.

# CDS4-R1 Screw clamp female plugs

## Female plug - 6 mm 0.236 in spacing

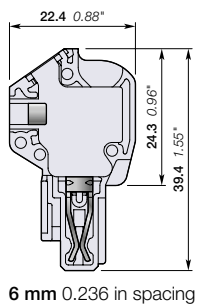
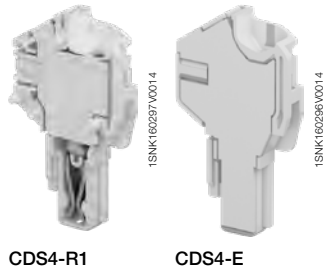
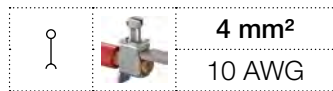

### Description

- Create your own female plug assemblies without any special tools, easily snap together multiple plugs for optimal ergonomics and quick assembly,
- Increase your flexibility: eliminate stock of pre-configured female plugs, easily add an extra plug in case of needed modification,
- Reduce your stock of unitary plugs up to 30%: only two plug variants are required to compose your own subsets of plugs from 2 to 15 poles.

### Ordering details

Description	Color	Type	Part Number	Pkg qty	Weight (1 pce) g
Female plugs	Grey <input type="checkbox"/>	CDS4-R1	1SNK806714R0000	50	4.10
Female plugs without outer nubs - Closed		CDS4-E	1SNK805715R0000	50	4.10

### Main technical data

Connecting capacity		IEC	UL - CSA	Mounting instructions	
1 conductor per clamp	Rigid: Solid/Stranded	0.2 ... 4 mm²	24 ... 10 AWG	Rail	
	Flexible without ferrule	0.22 ... 4 mm²		Wire stripping length	10.5 mm 0.413 in
	Flexible with non insulated ferrule	0.22 ... 4 mm²	24 ... 10 AWG		
	Flexible with insulated ferrule	0.22 ... 4 mm²	24 ... 10 AWG		
	Gauge	A3-B3			
2 conductors per clamp	Rigid: Solid/Stranded	0.2 ... 1.5 mm²	24 ... 16 AWG	Tool	Flat screwdriver Ø 3.5 mm Ø 0.138 in
	Flexible without ferrule	0.22 ... 1.5 mm²			
	Flexible with twin ferrule	0.22 ... 1.5 mm²	24 ... 16 AWG		
Rated current / Rated cross section		29 A / 4 mm²	28 A / 10 AWG	Torque	0.6 Nm ± 0.1 5.31 lb.in ± 0.885
Rated short-time withstand current (1s)		480 A			
Rated voltage		800 V	300 V		
Impulse withstand voltage		8000 V			
Protection		IP20	NEMA 1		

The connecting capacity data for one Rigid: Solid/Stranded, or one Flexible conductor (when applicable) is a mandatory information required by IEC, UL and CSA standards (Copper conductors). All other data are provided as supplementary information only. For more details, please consult our CB, UL or CSA certificates and technical datasheet available on <http://www.TE.com>

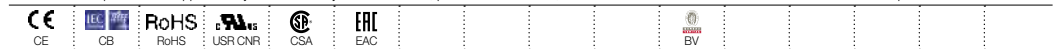

### Mounting instructions



### Accessories

Description	Color	Type	Part Number	Pkg qty	Weight (1 pce) g
1 Locking devices	Black <input checked="" type="checkbox"/>	VR-ZD	1SNK900637R0000	50	0.7
2 Cable Clamp	Dark grey <input checked="" type="checkbox"/>	PT-ZD	1SNK900660R0000	50	1.04
3 Terminal block markers	White <input type="checkbox"/>	MG-CPM 13 41791	1SNB041791R0612	1680	0.27
		MG-CPMFA 43196	1SNB043196R0012	350	2.56
		MC612	1SNK150000R0000	22	10.00
		MC612PA	1SNK159999R0000	20	11.00
	Universal wire markers holder	Grey <input type="checkbox"/>	UMH	1SNK900611R0000	10

Complete list of accessories is indicated in the terminal block datasheet including end stops. Some accessories such as jumper bars may modify the terminal block's ratings: Complete information available in the accessories section of the catalog.

Technical data valid for copper conductors only.



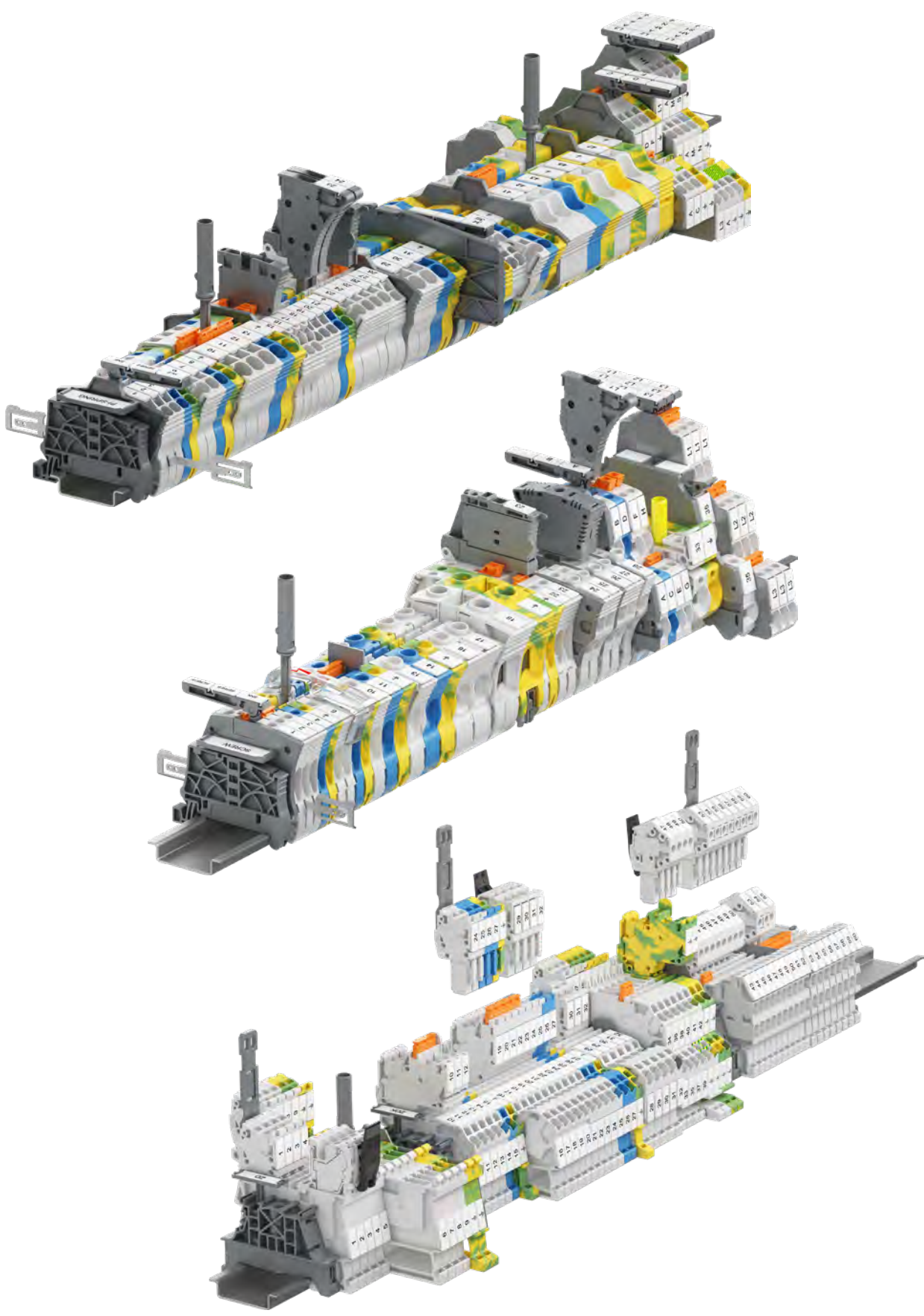

## SNK series, terminal block accessories

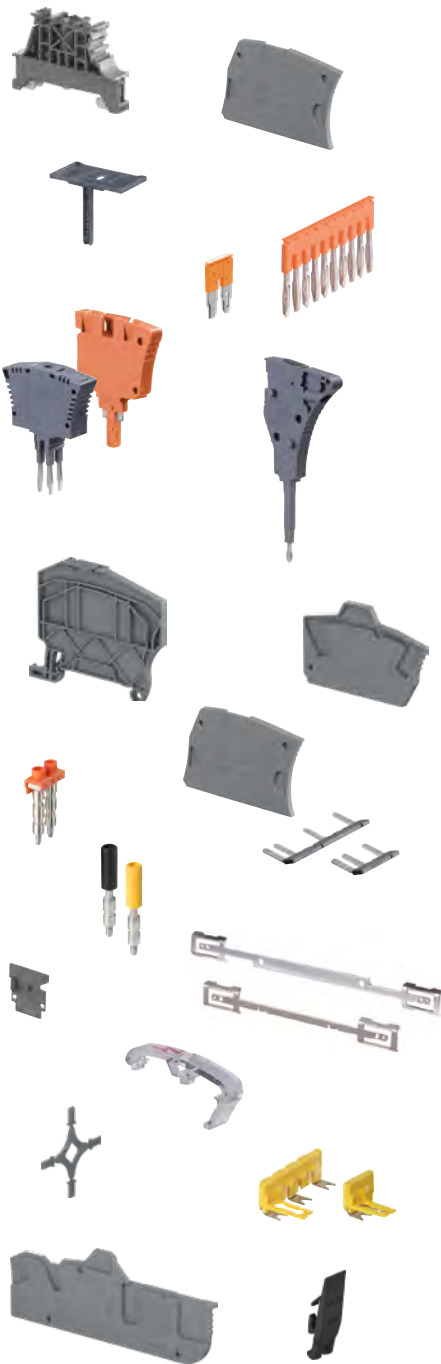

### Common terminal block accessories

Mounting rail	PR	196-198
Screw end stops	BAM4, BAZH1	199
Screwless end stops	BAZ1	200
Label holders	LH, LH-R1	201
	LH-J	202
Screwless jumper bars	JB5	203
	JB6	204
	JB8	205
	JB10	206
	JB12	207
Cross spacing jumpers	JB85-3	208
Test adapters	TP2, TP4	209
Test connectors	TC5	210
Component plugs	PG5-R2	211
	PG5, PG5-R1	212
Screwdrivers	TO	213
Crimping tools	PS	213

### PI-Spring terminal block accessories

End sections	EK	214-216
Circuit separators	CS-R2, CS-R3	217-218
Shield connectors	SHBP, SHB	219

### Screw clamp terminal block accessories

End sections	ES	220-221
Screw jumper bars	JB8	222
	JB16, JB22	223
	JB26	224
	BJMI31, BJMI36	225
Lateral jumper bars	PC8, PC81	226
Circuit separator	CS, CS-R1	227
Shield connectors	SHBS, SHB	228
Protecting covers	PL	229
	CO, KCO	230
Short circuit bridges	SC-JB8	231
Test sockets	AJS9	232

### Pluggable terminal block accessories

End sections	EDK, EDS	233-234
Coding pegs	COP	235
Locking devices	VR	235

# PR mounting rail

## Common terminal block accessories



1SNK160017S0201

PR30

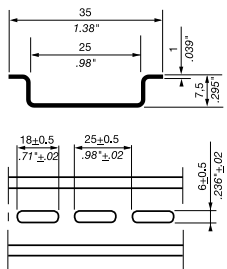

2000 mm 78.74 in spacing

### Description

- Pre-punched symmetrical mounting rail,
- The slotted holes ease the mounting and allow to use existing and/or numerous fixings,
- Particularly well designed for fixing onto back-plates and for terminal assemblies of small dimensions.

### Ordering details

Description	Color	Type	Part Number	Pkg meter	Weight (1 pce) <b>g</b>
Prepunched rail		PR30	1SNA173220R0500	2	328.00

Please note that for all rails: 1 part number equal 1 meter (39 in). Packing of 2 meters (78 in) minimum. Check that your order quantity is a multiple of 2.

### Main technical data

Material	Zinc plating and passivation steel				
Rail	TH 35-7.5				
	IEC	UL - CSA			
Equivalent E-Cu cross section	All the main technical data provided are "manufacturer" values.				
RoHS	RoHS				

### Mounting instructions

- In order to guarantee the performances and security of your installation, please ensure the rail and its fixings can withstand the static and dynamic loads of the components mounted on it;
- To prevent the rail from flexing (1 mm 0.039 in rail thickness only), fixing is recommended every 250 mm 9.84 in;
- To prevent any issues during mounting, screw heads used for rail fixing should not protrude from the rail (7,5 mm 0.295 in rail height only).



1SNK160017S0201

PR3.Z2

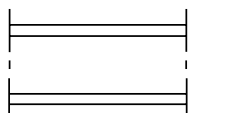
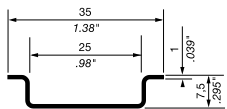

2000 mm 78.74 in spacing

### Description

- Symmetrical mounting rail complying with IEC60715,
- Particularly well designed for fixing onto back-plates and for terminal assemblies of small dimensions.

### Ordering details

Description	Color	Type	Part Number	Pkg meter	Weight (1 pce) <b>g</b>
		PR3.Z2	1SNA174300R1700	2	718.00

Please note that for all rails: 1 part number equal 1 meter (39 in). Packing of 2 meters (78 in) minimum. Check that your order quantity is a multiple of 2.

### Main technical data

Material	Zinc plating and passivation steel				
Rail	TH 35-7.5				
	IEC	UL - CSA			
Equivalent E-Cu cross section	16 mm <sup>2</sup>				
	All the main technical data provided are "manufacturer" values.				
RoHS	RoHS				

### Mounting instructions

- In order to guarantee the performances and security of your installation, please ensure the rail and its fixings can withstand the static and dynamic loads of the components mounted on it;
- To prevent the rail from flexing (1 mm 0.039 in rail thickness only), fixing is recommended every 250 mm 9.84 in;
- To prevent any issues during mounting, screw heads used for rail fixing should not protrude from the rail (7,5 mm 0.295 in rail height only).

Technical data valid for copper conductors only.

# PR mounting rail

## Common terminal block accessories



1SNA600073F0000

PR3.G2

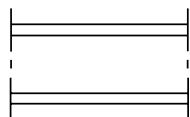
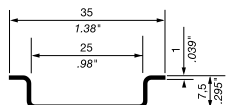

2000 mm 78.74 in spacing

### Description

- Symmetrical mounting rail made of galvanised steel, complying with IEC60715,
- Particularly well designed for fixing onto back-plates and for terminal assemblies of small dimensions.

### Ordering details

Description	Color	Type	Part Number	Pkg meter	Weight (1 pce) g
		PR3.G2	1SNA164800R0300	2	718.00

Please note that for all rails: 1 part number equal 1 meter (39 in). Packing of 2 meters (78 in) minimum. Check that your order quantity is a multiple of 2.

### Main technical data

Material	Galvanised steel		
Rail	TH 35-7.5		
	IEC	UL - CSA	
Equivalent E-Cu cross section	16 mm <sup>2</sup>		

All the main technical data provided are "manufacturer" values.

RoHS																			
RoHS																			

### Mounting instructions

- In order to guarantee the performances and security of your installation, please ensure the rail and its fixings can withstand the static and dynamic loads of the components mounted on it;
- To prevent the rail from flexing (1 mm 0.039 in rail thickness only), fixing is recommended every 250 mm 9.84 in;
- To prevent any issues during mounting, screw heads used for rail fixing should not protrude from the rail (7,5 mm 0.295 in rail height only).



1SNA600074F0000

PR50

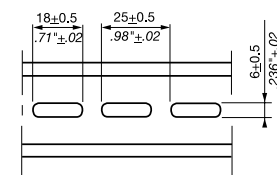
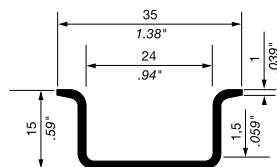

2000 mm 78.74 in spacing

### Description

- Pre-punched symmetrical mounting rail,
- The slotted holes ease the mounting and allow to use existing and/or numerous fixings.

### Ordering details

Description	Color	Type	Part Number	Pkg meter	Weight (1 pce) g
Prepunched rail		PR50	1SNA178529R0400	2	1288.00

Please note that for all rails: 1 part number equal 1 meter (39 in). Packing of 2 meters (78 in) minimum. Check that your order quantity is a multiple of 2.

### Main technical data

Material	Zinc plating and passivation steel		
Rail	TH 35-15		
	IEC	UL - CSA	
Equivalent E-Cu cross section			

All the main technical data provided are "manufacturer" values.

RoHS																			
RoHS																			

### Mounting instructions

- In order to guarantee the performances and security of your installation, please ensure the rail and its fixings can withstand the static and dynamic loads of the components mounted on it;
- To prevent the rail from flexing, fixing is recommended every 700 mm 27.6 in;
- In order to increase the accessibility of your terminal assembly, we recommend the use of our rail offset brackets EM45 (order code 1SNA008521R2600) for a 45° orientation of the rail.

Technical data valid for copper conductors only.

# PR mounting rail

## Common terminal block accessories

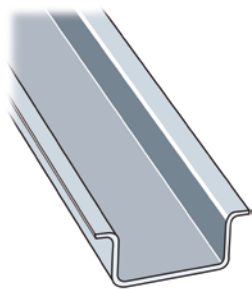

1SNK160041S0201

PR5

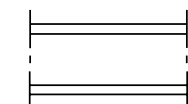
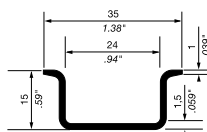

2000 mm 78.74 in spacing

### Description

- Symmetrical mounting rail.

### Ordering details

Description	Color	Type	Part Number	Pkg meter	Weight (1 pce) g
		PR5	1SNA168700R2200	2	1200.00

Please note that for all rails: 1 part number equal 1 meter (39 in). Packing of 2 meters (78 in) minimum. Check that your order quantity is a multiple of 2.

### Main technical data

Material	Zinc plating and passivation steel
Rail	TH 35-15

	IEC	UL - CSA
--	-----	----------

### Equivalent E-Cu cross section

All the main technical data provided are "manufacturer" values.

RoHS									
RoHS									

### Mounting instructions

- In order to guarantee the performances and security of your installation, please ensure the rail and its fixings can withstand the static and dynamic loads of the components mounted on it;
- To prevent the rail from flexing, fixing is recommended every 700 mm 27.6 in;
- In order to increase the accessibility of your terminal assembly, we recommend the use of our rail offset brackets EM45 (order code 1SNA008521R2600) for a 45° orientation of the rail.



1SNK160041S0201

PR4

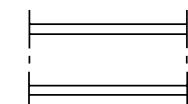
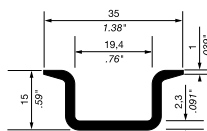

2000 mm 78.74 in spacing

### Description

- Symmetrical mounting rail complying with IEC60715,
- The rigidity of the rail is maximised by the 2.3 mm 0.090 in thickness of the rail, and by its solid, non slotted construction,
- PR4 TH 35-15 is the most rigid mounting rail solution and it can support

### Ordering details

Description	Color	Type	Part Number	Pkg meter	Weight (1 pce) g
Recommended for SNK ground terminal blocks up to 35 mm² 2 AWG		PR4	1SNA168500R1200	2	915.00

Please note that for all rails: 1 part number equal 1 meter (39 in). Packing of 2 meters (78 in) minimum. Check that your order quantity is a multiple of 2.

### Main technical data

Material	Zinc plating and passivation steel
Rail	TH 35-15

	IEC	UL - CSA
--	-----	----------

### Equivalent E-Cu cross section

All the main technical data provided are "manufacturer" values.

RoHS									
RoHS									

### Mounting instructions

- In order to guarantee the performances and security of your installation, please ensure the rail and its fixings can withstand the static and dynamic loads of the components mounted on it;
- To prevent the rail from flexing, fixing is recommended every 700 mm 27.6 in;
- In order to increase the accessibility of your terminal assembly, we recommend the use of our rail offset brackets EM45 (order code 1SNA008521R2600) for a 45° orientation of the rail.

Technical data valid for copper conductors only.





## Screw end stops

### Common terminal block accessories

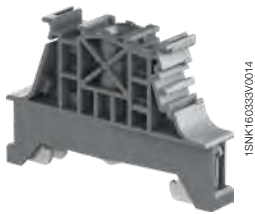

1SNK160333V0014

BAM4

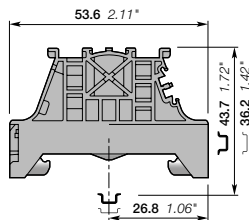

10 mm 0.394 in spacing

#### Mounting instructions



## BAM4 screw end stops

### Description

- Give efficient support to the SNK terminal blocks assemblies thanks to the BAM4 double gripping rail contact,
- Ease the assemblies identification with the BAM4 marking location compatible with all SNK markers and labels.

### Ordering details

Description	Color	Type	Part Number	Pkg qty	Weight (1 pce) g
10 mm 0.394 in spacing	Dark grey	BAM4	1SNK900001R0000	50	14.00

### Main technical data

Material specifications	Insulating material	Polyamide	Rail		TH 35-7.5, TH 35-15
	Flammability	V0	Tool		Flat screwdriver Ø 5.5 mm Ø 0.217 in
	NF F 16 101	I2F2	Torque		0.9 Nm ± 0.1 7.08 lb.in ± 0.88
Ambient temperature min/max	Service IEC 60068-2-1	-55 ... +110 °C -67 ... +230 °F			
	Storage	-55 ... +110 °C -67 ... +230 °F			
	Installing	-5 ... +40 °C +23 ... +104 °F			

### Mounting instructions

All the main technical data provided are "manufacturer" values

RoHS	RoHS								
------	------	--	--	--	--	--	--	--	--

### Accessories

Description	Color	Type	Part Number	Pkg qty	Weight (1 pce) g	
Terminal block markers compatible with MG3	White <input type="checkbox"/>	MG-CPM 13 41791	1SNB041791R0612	1680	0.27	
Blank card	In polycarbonate	MC812	1SNK160000R0000	22	10.00	
	In polyamide	MC812PA	1SNK169999R0000	20	14.00	
Label holder	Dark grey <input checked="" type="checkbox"/>	10 mm 0.394 in width	LH	1SNK900605R0000	50	0.60
		19.5 mm 0.768 in width	LH-R1	1SNK900607R0000	50	1.10
Universal wire markers holder	Grey <input type="checkbox"/>	UMH	1SNK900611R0000	10	0.20	

## BAZH1 screw end stops

### Description

- Give efficient support to the SNK double deck or power terminal blocks assemblies thanks to the BAZH1 double gripping rail contact,
- Ease the assemblies identification with label holders.

### Ordering details

Description	Color	Type	Part Number	Pkg qty	Weight (1 pce) g
10 mm 0.394 in spacing	Dark grey	BAZH1	1SNK900102R0000	20	24.00

### Main technical data

Material specifications	Insulating material	Polyamide	Rail		TH 35-7.5
	Flammability	V0	Tool		Flat screwdriver Ø 5.5 mm Ø 0.217 in
	NF F 16 101	I2F2	Torque		1.3 Nm ± 0.1 11.4 lb.in ± 0.88
Ambient temperature min/max	Service IEC 60068-2-1	-55 ... +110 °C -67 ... +230 °F			
	Storage	-55 ... +110 °C -67 ... +230 °F			
	Installing	-5 ... +40 °C +23 ... +104 °F			

### Mounting instructions

All the main technical data provided are "manufacturer" values

RoHS	RoHS								
------	------	--	--	--	--	--	--	--	--

### Accessories

Description	Color	Type	Part Number	Pkg qty	Weight (1 pce) g	
Terminal block markers compatible with MG3	White <input type="checkbox"/>	MG-CPM 13 41791	1SNB041791R0612	1680	0.27	
Blank card	In polycarbonate	MC812	1SNK160000R0000	22	10.00	
	In polyamide	MC812PA	1SNK169999R0000	20	14.00	
Label holder	Dark grey <input checked="" type="checkbox"/>	10 mm 0.394 in width	LH	1SNK900605R0000	50	0.60
		19.5 mm 0.768 in width	LH-R1	1SNK900607R0000	50	1.10
Universal wire markers holder	Grey <input type="checkbox"/>	UMH	1SNK900611R0000	10	0.20	

Technical data valid for copper conductors only.

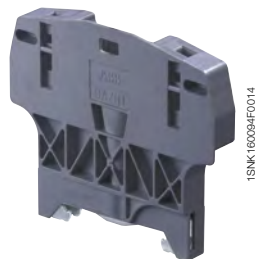

1SNK160094R0014

BAZH1

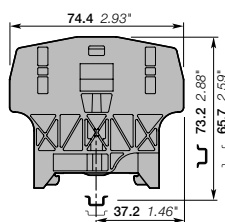

10 mm 0.394 in spacing



## Label holder

### Common terminal block accessories



1SNK1603340014

LH  
10 mm 0.394 in spacing

## LH label holder

### Description

- Easily identify your terminal blocks assembly with white or yellow labels,
- Adjustable in height for best visibility,
- Compatible with all SNK end stops.

### Ordering details

Description	Color	Type	Part Number	Pkg qty	Weight (1 pce) g
10 mm 0.394 in width	Dark grey <input checked="" type="checkbox"/>	LH	1SNK900605R0000	50	0.60

### Main technical data

Material specifications	Insulating material Flammability NF F 16 101	Polyamide V0 I2F2			
Ambient temperature min/max	Service IEC 60068-2-1	-55 ... +110 °C	-67 ... +230 °F		
	Storage	-55 ... +110 °C	-67 ... +230 °F		
	Installing	-5 ... +40 °C	+23 ... +104 °F		

All the main technical data provided are "manufacturer" values

RoHS  
RoHS

### Accessories

Description	Color	Type	Part Number	Pkg qty	Weight (1 pce) g
Self-adhesive precut blank label compatible with HTP500	White <input type="checkbox"/>	MCLH	1SNK900630R0000	25	10.00
Self-adhesive precut blank label compatible with HTP500	White <input type="checkbox"/>	RCPEAD-TT	1SNA235158R0100	25	9.80
	Yellow <input type="checkbox"/>	RCPEAD-TT-YL	1SNA235159R0200	25	12.10
Pre-printed cover marker	Transparent <input checked="" type="checkbox"/>	EPR2	1SNA399726R0700	10	4.00
Precut blank label compatible with MG3	White <input type="checkbox"/>	MG-TAR 45490	1SNB045490R8530	1650	0.371
Self-adhesive precut blank label compatible with MG3	Yellow <input type="checkbox"/>	MG-TAA 49448	1SNB049448R8530	825	0.55
	White <input type="checkbox"/>	MG-TAA 49498	1SNB049498R8530	825	0.55
Self-adhesive precut blank label compatible with HTP500	Yellow <input type="checkbox"/>	MCLH-YL	1SNK900633R0000	25	10.00



1SNK1603350014

LH  
19.5 mm 0.768 in spacing

## LH-R1 label holder

### Description

- Easily identify your terminal blocks assembly with white or yellow labels,
- Adjustable in height for best visibility,
- Compatible with all SNK end stops.

### Ordering details

Description	Color	Type	Part Number	Pkg qty	Weight (1 pce) g
19.5 mm 0.768 in width	Dark grey <input checked="" type="checkbox"/>	LH-R1	1SNK900607R0000	50	1.10

### Main technical data

Material specifications	Insulating material Flammability NF F 16 101	Polyamide V0 I2F2			
Ambient temperature min/max	Service IEC 60068-2-1	-55 ... +110 °C	-67 ... +230 °F		
	Storage	-55 ... +110 °C	-67 ... +230 °F		
	Installing	-5 ... +40 °C	+23 ... +104 °F		

All the main technical data provided are "manufacturer" values

RoHS  
RoHS

### Accessories

Description	Color	Type	Part Number	Pkg qty	Weight (1 pce) g
Self-adhesive precut blank label compatible with HTP500	White <input type="checkbox"/>	MCLH-R1	1SNK900631R0000	25	10.00
Precut blank label compatible with AMS600	White <input type="checkbox"/>	RCPEB	1SNA178430R0500	1	
	Transparent <input checked="" type="checkbox"/>	EPR1	1SNA178431R2200	1	0.05
Self-adhesive precut blank label compatible with HTP500	White <input type="checkbox"/>	PIB2-TT	1SNA235155R2600	25	9.70
	Yellow <input type="checkbox"/>	PIB2-TT-YL	1SNA235157R2000	25	9.40
Precut blank label compatible with MG3	White <input type="checkbox"/>	MG-TAR 45194	1SNB045194R1735	900	0.62
Self-adhesive precut blank label compatible with MG3	Yellow <input type="checkbox"/>	MG-TAA 49148	1SNB049148R1735	450	0.91
	White <input type="checkbox"/>	MG-TAA 49198	1SNB049198R1735	450	0.91
Self-adhesive precut blank label compatible with HTP500	Yellow <input type="checkbox"/>	MCLH-R1-YL	1SNK900634R0000	25	10.00

Technical data valid for copper conductors only.

### Mounting instructions



## Label holder

### Common terminal block accessories



1SNK1603470014

LH

4.8 mm 0.189 in spacing

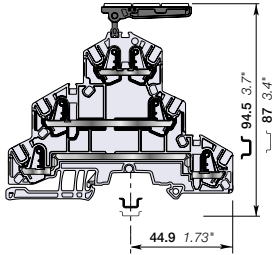

## LH-J label holder

### Description

Easily identify your block with three standard 5.2 mm 0.205 in spacing SNK markers. It fits in the jumper channel of the SNK terminal blocks.

### Ordering details

Description	Color	Type	Part Number	Pkg qty	Weight (1 pce) g
Rotating label holder with three SNK markers housings - 4.8 mm 0.189 in spacing	Dark grey <input checked="" type="checkbox"/>	LH-J	1SNK900606R0000	100	0.73

### Main technical data

Material specifications	Insulating material	Polyamide			
	Flammability	V0			
	NF F 16 101	I2F2			
Ambient temperature min/max	Service IEC 60068-2-1	-55 ... +110 °C	-67 ... +230 °F		
	Storage	-55 ... +110 °C	-67 ... +230 °F		
	Installing	-5 ... +40 °C	+23 ... +104 °F		

All the main technical data provided are "manufacturer" values

<b>RoHS</b>	<input checked="" type="checkbox"/>				
RoHS					

### Accessories

Description	Color	Type	Part Number	Pkg qty	Weight (1 pce) g
Blank marker compatible with MG3	White <input type="checkbox"/>	MG-CPM 13 41790	1SNB041790R0512	1960	0.23
Blank card compatible with HTP500	White <input type="checkbox"/>	MC512	1SNK140000R0000	22	9.00
	White <input type="checkbox"/>	MC512PA	1SNK149999R0000	20	10.00
Universal wire markers holder 5.2 mm 0.205 in spacing	Grey <input type="checkbox"/>	UMH	1SNK900611R0000	10	0.20

Technical data valid for copper conductors only.

# JB5 screwless jumper bars

## Common terminal block accessories



1SNK160143F0014

JB5  
5.2 mm 0.205 in spacing

### Description

Facilitate & secure your jumper bar assembly process:

- Screwless mounting,
- Pre-cut poles for alternated jumpering between terminal blocks,
- Insulated,
- Positive locking,
- Perfectly adapted to low level electrical contact (20mA, 50mV).

### Ordering details

Description		Color	Type	Part Number	Pkg qty	Weight (1 pce) g
5.2 mm 0.205 in spacing	2 poles	Orange	JB5-2	1SNK905302R0000	50	1.30
	3 poles		JB5-3	1SNK905303R0000	50	2.00
	4 poles		JB5-4	1SNK905304R0000	50	2.70
	5 poles		JB5-5	1SNK905305R0000	50	3.50
	10 poles		JB5-10	1SNK905310R0000	30	7.10
	50 poles		JB5-50	1SNK905350R0000	10	36.00

### Main technical data

<b>Material specifications</b>	Insulating material	Polyamide		
	Flammability	V0		
<b>Ambient temperature min/max</b>	NF F 16 101	I2F3		
	Service IEC 60068-2-1	-55 ... +110 °C	-67 ... +230 °F	
	Storage	-55 ... +110 °C	-67 ... +230 °F	
	Installing	-5 ... +40 °C	+23 ... +104 °F	
		<b>IEC</b>	<b>UL - CSA</b>	<b>Ex e</b>
<b>Rated current</b>		32 A	30 A	
<b>Rated voltage</b>	1 - Standard use	1000 V	600 V	Please consult us
	2 - Cut extremities	800 V	300 V	
	3 - Cut poles	630 V	300 V	
	4 - Alternated poles	400 V	150 V	
	5 - Alternated poles with cut extremities	400 V	150 V	
<b>Impulse withstand voltage</b>		8000 V		
<b>Protection</b>		IP20	NEMA 1	
All the main technical data are indicative "manufacturer" values.				
	<b>RoHS</b>			
	RoHS			

### Mounting instructions

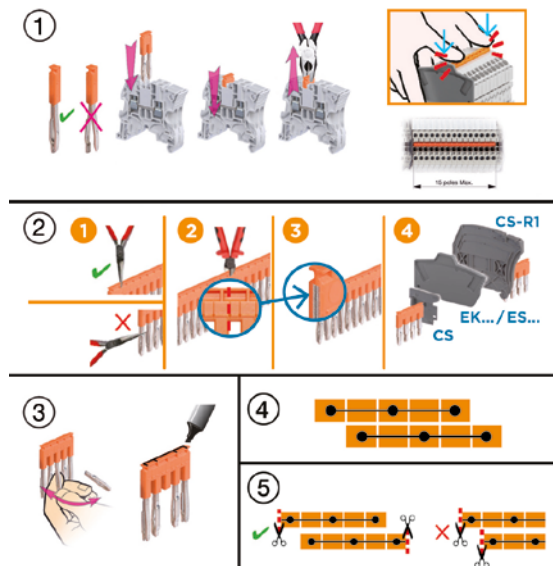

#### 1 - Standard use

#### 2 - Cut extremities

For voltage rating > 50 V and Uimp > 2.5 KV, the below accessories must be installed on the cut side of the jumper to guarantee IP20 and voltage rating:

ZS...	Feed-through	CS circuit separator
ZK...	Double deck / triple deck	ES... end section
	All functions	EK... end section

Ensure a good straight cut by positioning the cutting tool on the vertical snicks of the insulated part of the jumper.

15 poles max. recommended for convenient mounting.

#### 3 - Cut poles

#### 4 - Alternated poles

#### 5 - Alternated poles with cut extremities

When using cut jumpers, cut extremities should be placed oppositely to allow end sections / circuit separators placement at each cut extremities.

For all other applications, please consult us.

Technical data valid for copper conductors only.



# JB6 screwless jumper bars

## Common terminal block accessories



1SNK160143P0014

**JB6**  
6 mm 0.236 in spacing

### Description

Facilitate & secure your jumper bar assembly process:

- Screwless mounting,
- Pre-cut poles for alternated jumpering between terminal blocks,
- Insulated,
- Positive locking,
- Perfectly adapted to low level electrical contact (20mA, 50mV).

### Ordering details

Description		Color	Type	Part Number	Pkg qty	Weight (1 pce) g
6 mm 0.236 in spacing	2 poles	Orange	JB6-2	1SNK906302R0000	50	1.30
	3 poles		JB6-3	1SNK906303R0000	50	2.10
	4 poles		JB6-4	1SNK906304R0000	50	2.90
	5 poles		JB6-5	1SNK906305R0000	50	3.60
	10 poles		JB6-10	1SNK906310R0000	20	7.40
	50 poles		JB6-50	1SNK906350R0000	10	38.10

### Main technical data

<b>Material specifications</b>	Insulating material	Polyamide		
	Flammability	V0		
	NF F 16 101	I2F3		
<b>Ambient temperature min/max</b>	Service IEC 60068-2-1	-55 ... +110 °C	-67 ... +230 °F	
	Storage	-55 ... +110 °C	-67 ... +230 °F	
	Installing	-5 ... +40 °C	+23 ... +104 °F	
		<b>IEC</b>	<b>UL - CSA</b>	<b>Ex e</b>
<b>Rated current</b>		41 A	30 A	
<b>Rated voltage</b>	1 - Standard use	1000 V	600 V	Please consult our dedicated certificates
	2 - Cut extremities	800 V	300 V	
	3 - Cut poles	630 V	300 V	
	4 - Alternated poles	400 V	150 V	
	5 - Alternated poles with cut extremities	400 V	150 V	
<b>Impulse withstand voltage</b>		8000 V		
<b>Protection</b>		IP20	NEMA 1	
All the main technical data are indicative "manufacturer" values.				
	<b>RoHS</b> RoHS			

### Mounting instructions

**1 - Standard use**

**2 - Cut extremities**  
For voltage rating > 50 V and Uimp > 2.5 KV, the below accessories must be installed on the cut side of the jumper to guarantee IP20 and voltage rating:

ZS...	Feed-through	CS circuit separator
ZK...	Double deck / triple deck	ES... end section
	All functions	EK... end section

Ensure a good straight cut by positioning the cutting tool on the vertical snicks of the insulated part of the jumper.

15 poles max. recommended for convenient mounting.

**3 - Cut poles**

**4 - Alternated poles**

**5 - Alternated poles with cut extremities**  
When using cut jumpers, cut extremities should be placed oppositely to allow end sections / circuit separators placement at each cut extremities.

For all other applications, please consult us.

Technical data valid for copper conductors only.

1SNK160029S0201

# JB8 screwless jumper bars

## Common terminal block accessories



1SNK160146P0014

**JB8**  
8 mm 0.315 in spacing

### Description

Facilitate & secure your jumper bar assembly process:

- Screwless mounting,
- Pre-cut poles for alternated jumpering between terminal blocks,
- Insulated,
- Positive locking,
- Perfectly adapted to low level electrical contact (20mA, 50mV).

### Ordering details

Description		Color	Type	Part Number	Pkg qty	Weight (1 pce) g
8 mm 0.315 in spacing	2 poles	Orange	JB8-2	1SNK908302R0000	50	2.70
	3 poles		JB8-3	1SNK908303R0000	50	4.10
	4 poles		JB8-4	1SNK908304R0000	50	5.60
	5 poles		JB8-5	1SNK908305R0000	40	7.00
	10 poles		JB8-10	1SNK908310R0000	20	14.20

### Main technical data

Material specifications	Insulating material	Polyamide		
	Flammability	V0		
	NF F 16 101	I2F3		
Ambient temperature min/max	Service IEC 60068-2-1	-55 ... +110 °C	-67 ... +230 °F	
	Storage	-55 ... +110 °C	-67 ... +230 °F	
	Installing	-5 ... +40 °C	+23 ... +104 °F	
		<b>IEC</b>	<b>UL - CSA</b>	<b>Ex e</b>
Rated current		57 A	42 A	
Rated voltage	1 - Standard use	1000 V	600 V	693 V
	2 - Cut extremities	800 V	300 V	440 V
	3 - Cut poles	630 V	300 V	440 V
	4 - Alternated poles	630 V	150 V	352 V
	5 - Alternated poles with cut extremities	630 V	150 V	352 V
Impulse withstand voltage		6000 V		
Protection		IP20	NEMA 1	
All the main technical data are indicative "manufacturer" values.				
	<b>RoHS</b>			
	RoHS			

### Mounting instructions

①

②

③

④

⑤

**1 - Standard use**

**2 - Cut extremities**  
For voltage rating > 50 V and Uimp > 2.5 KV, the below accessories must be installed on the cut side of the jumper to guarantee IP20 and voltage rating:

ZS...	Feed-through	CS circuit separator
	Double deck / triple deck	ES... end section
ZK...	All functions	EK... end section

Ensure a good straight cut by positioning the cutting tool on the vertical snicks of the insulated part of the jumper.

**3 - Cut poles**

**4 - Alternated poles**

**5 - Alternated poles with cut extremities**  
When using cut jumpers, cut extremities should be placed oppositely to allow end sections / circuit separators placement at each cut extremities.

For all other applications, please consult us.

Technical data valid for copper conductors only.

# JB10 screwless jumper bars

## Common terminal block accessories



1SNK16014BFT014

**JB10**  
10 mm 0.394 in spacing

### Description

Facilitate & secure your jumper bar assembly process:

- Screwless mounting,
- Pre-cut poles for alternated jumpering between terminal blocks,
- Insulated,
- Positive locking,
- Perfectly adapted to low level electrical contact (20mA, 50mV).

### Ordering details

Description		Color	Type	Part Number	Pkg qty	Weight (1 pce) g
10 mm 0.394 in spacing	2 poles	Orange	JB10-2	1SNK910302R0000	50	4.60
	3 poles		JB10-3	1SNK910303R0000	50	7.10
	4 poles		JB10-4	1SNK910304R0000	40	9.40
	5 poles		JB10-5	1SNK910305R0000	30	12.00
	10 poles		JB10-10	1SNK910310R0000	20	24.00

### Main technical data

Material specifications	Insulating material	Polyamide		
	Flammability	V0		
	NF F 16 101	I2F3		
Ambient temperature min/max	Service IEC 60068-2-1	-55 ... +110 °C	-67 ... +230 °F	
	Storage	-55 ... +110 °C	-67 ... +230 °F	
	Installing	-5 ... +40 °C	+23 ... +104 °F	
Rated current		IEC	UL - CSA	Ex e
		76 A	67 A	
Rated voltage	1 - Standard use	1000 V	600 V	693 V
	2 - Cut extremities	800 V	300 V	440 V
	3 - Cut poles	630 V	300 V	440 V
	4 - Alternated poles	400 V	150 V	275 V
	5 - Alternated poles with cut extremities	250 V	150 V	176 V
Impulse withstand voltage		6000 V		
Protection		IP20	NEMA 1	
All the main technical data are indicative "manufacturer" values.				
	RoHS			
	RoHS			

### Mounting instructions

**1 - Standard use**

**2 - Cut extremities**  
For voltage rating > 50 V and Uimp > 2.5 KV, the below accessories must be installed on the cut side of the jumper to guarantee IP20 and voltage rating:

ZS...	Feed-through	CS circuit separator
	Double deck / triple deck	ES... end section
ZK...	All functions	EK... end section

Ensure a good straight cut by positioning the cutting tool on the vertical snicks of the insulated part of the jumper.

**3 - Cut poles**

**4 - Alternated poles**

**5 - Alternated poles with cut extremities**  
When using cut jumpers, cut extremities should be placed oppositely to allow end sections / circuit separators placement at each cut extremities.

For all other applications, please consult us.

Technical data valid for copper conductors only.

# JB12 screwless jumper bars

## Common terminal block accessories



1SNK160239V0014

**JB12**  
12 mm 0.472 in spacing

### Description

Facilitate & secure your jumper bar assembly process:

- Screwless mounting,
- Pre-cut poles for alternated jumpering between terminal blocks,
- Insulated,
- Positive locking,
- Perfectly adapted to low level electrical contact (20mA, 50mV).

### Ordering details

Description	Color	Type	Part Number	Pkg qty	Weight (1 pce) g
12 mm 0.472 in spacing	Orange	JB12-2	1SNK912302R0000	50	4.90
		JB12-3	1SNK912303R0000	50	7.60
		JB12-5	1SNK912305R0000	20	12.90

### Main technical data

Material specifications	Insulating material	Polyamide		
	Flammability	V0		
	NF F 16 101	I2F2		
Ambient temperature min/max	Service IEC 60068-2-1	-55 ... +110 °C	-67 ... +230 °F	
	Storage	-55 ... +110 °C	-67 ... +230 °F	
	Installing	-5 ... +40 °C	+23 ... +104 °F	
		IEC	UL - CSA	Ex e
Rated current		76 A	67 A	
Rated voltage	1 - Standard use	1000 V	600 V	693 V
	2 - Cut extremities	800 V	300 V	440 V
	3 - Cut poles	630 V	300 V	440 V
	4 - Alternated poles	320 V	150 V	220 V
	5 - Alternated poles with cut extremities	250 V	150 V	176 V
Impulse withstand voltage		6000 V		
Protection		IP20	NEMA 1	
All the main technical data are indicative "manufacturer" values.				
	RoHS			
	RoHS			

### Mounting instructions

**1**

**2**

**3**

**4**

**5**

**1 - Standard use**

**2 - Cut extremities**  
For voltage rating > 50 V and Uimp > 2.5 KV, the below accessories must be installed on the cut side of the jumper to guarantee IP20 and voltage rating:

ZS...	Feed-through	CS circuit separator
	Double deck / triple deck	ES... end section
ZK...	All functions	EK... end section

Ensure a good straight cut by positioning the cutting tool on the vertical snicks of the insulated part of the jumper.

**3 - Cut poles**

**4 - Alternated poles**

**5 - Alternated poles with cut extremities**  
When using cut jumpers, cut extremities should be placed oppositely to allow end sections / circuit separators placement at each cut extremities.

For all other applications, please consult us.

Technical data valid for copper conductors only.

# JB85-3 cross spacing jumpers

## Common terminal block accessories



**JB85**  
8 mm 0.315 in spacing

### Description

- Allows power distribution between terminal blocks with different spacing,
- JB5-3, JB6-3 and JB8-3 can be used as cross spacing jumpers (see selection table on mounting instructions below).

### Ordering details

Description	Color	Type	Part Number	Pkg qty	Weight (1 pce)
Cross spacing jumpers : 3 poles	Orange	JB85-3	1SNK900603R0000	10	2.80 g

### Main technical data

Material specifications	Insulating material	Polyamide		
	Flammability	V0		
	NF F 16 101	I2F3		
Ambient temperature min/max	Service IEC 60068-2-1	-55 ... +110 °C	-67 ... +230 °F	
	Storage	-55 ... +110 °C	-67 ... +230 °F	
	Installing	-5 ... +40 °C	+23 ... +104 °F	
Rated current		IEC : 32 A	UL - CSA : 30 A	Ex e Please consult our dedicated certificates
Rated voltage	Standard use	1000 V	600 V	
	Cut extremities	800 V	300 V	
	Cut poles	630 V	300 V	
Impulse withstand voltage		8000 V		
Protection		IP20	NEMA 1	

All the main technical data provided are "manufacturer" values

RoHS	RoHS								
------	------	--	--	--	--	--	--	--	--

### Mounting instructions

Cross spacing jumper selection between A and B terminal blocks with different spacing.

	B	5.2 mm	6 mm	8 mm
A				
6 mm		JB5.3	-	-
8 mm		JB85.3	JB85.3	-
10 mm		JB85.3	JB85.3	JB8.3
12 mm		JB85.3	JB6.3	-

Yellow cell: for ZS and ZK terminal blocks

Blue cell: for ZS terminal blocks only

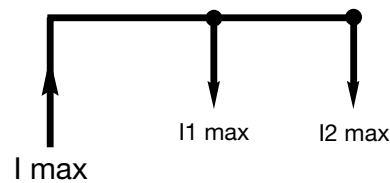

$$I1 \text{ max} + I2 \text{ max} \leq I \text{ max}$$

$$I1 \text{ max} \leq I \text{ rated terminal block}$$

$$I2 \text{ max} \leq I \text{ rated terminal block}$$

Technical data valid for copper conductors only.



## Test adapters

### Common terminal block accessories



TP  
7.6 mm 0.299 in spacing

#### Mounting instructions

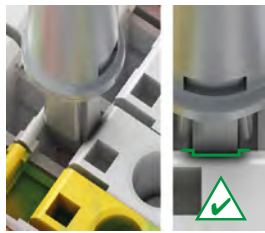

## TP2 test adapters

### Description

- Insulated test adapter that enables individual voltage control,
- Direct plug-in solution into the jumpers channels,
- Compatible with standard isolated or non isolated test plugs DIA 2 mm 0.079 in and 2.3 mm 0.090 in,
- Withstand more than 10000 operations according to TE Connectivity test standards.

### Ordering details

Description	Color	Type	Part Number	Pkg qty	Weight (1 pce)
For test plugs DIA 2 mm 0.079 in	Dark grey	TP2	1SNK900203R0000	20	1.70

### Main technical data

Material specifications	Insulating material	Polyamide		
	Flammability	V0		
	NF F 16 101	I2F2		
Ambient temperature min/max	Service IEC 60068-2-1	-55 ... +110 °C	-67 ... +230 °F	
	Storage	-55 ... +110 °C	-67 ... +230 °F	
	Installing	-5 ... +40 °C	+23 ... +104 °F	
		<b>IEC</b>	<b>UL - CSA</b>	<b>Ex e</b>
Rated current		10 A		
Rated voltage	Standard use	1000 V	600 V	Not authorized
Impulse withstand voltage		8000 V		
Protection		IP20	NEMA 1	
All the main technical data provided are "manufacturer" values				
RoHS				
RoHS				



TP  
7.6 mm 0.299 in spacing

#### Mounting instructions

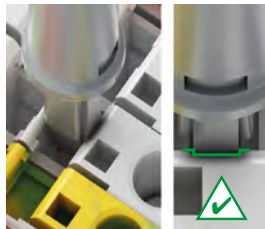

## TP4 test adapters

### Description

- Isolated test adapter that enables individual voltage control,
- Direct plug-in solution into the jumpers channels,
- Compatible with standard isolated or non isolated test plugs DIA 4 mm 0.157 in,
- Withstand more than 10000 operations according to TE Connectivity test standards.

### Ordering details

Description	Color	Type	Part Number	Pkg qty	Weight (1 pce)
For test plugs DIA 4 mm 0.157 in	Dark grey	TP4	1SNK900205R0000	20	2.40

### Main technical data

Material specifications	Insulating material	Polyamide		
	Flammability	V0		
	NF F 16 101	I2F2		
Ambient temperature min/max	Service IEC 60068-2-1	-55 ... +110 °C	-67 ... +230 °F	
	Storage	-55 ... +110 °C	-67 ... +230 °F	
	Installing	-5 ... +40 °C	+23 ... +104 °F	
		<b>IEC</b>	<b>UL - CSA</b>	<b>Ex e</b>
Rated current		16 A		
Rated voltage	Standard use	1000 V	600 V	Not authorized
Impulse withstand voltage		8000 V		
Protection		IP20	NEMA 1	
All the main technical data provided are "manufacturer" values				
RoHS				
RoHS				

Technical data valid for copper conductors only.

# TC5 test connectors

## Common terminal block accessories



5.2 mm 0.205 in spacing

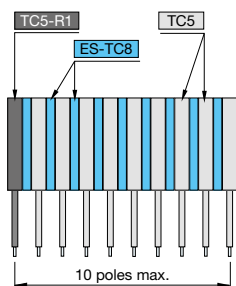
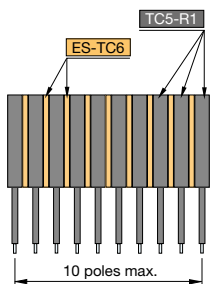
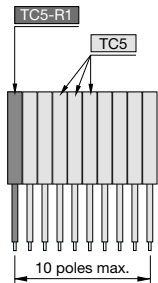



PT-3

### Description

Ease the testing of terminal block assemblies:

- Make your own test connector assembly with our modular solution mixing various spacings,
- Direct plug-in solution into the jumpers channels,
- Withstand more than 10000 operations according to TE Connectivity test standards.

### Main technical data

Connecting capacity		IEC	UL - CSA	Mounting instructions		
1 conductor per clamp	Rigid: Solid/Stranded	0.2 ... 1.5 mm <sup>2</sup>		Rail	Wire stripping length 	8 mm 0.314 in
	Flexible without ferrule	0.22 ... 1.5 mm <sup>2</sup>				
	Flexible with non insulated ferrule	0.22 ... 1.5 mm <sup>2</sup>		Tool 	Flat screwdriver Ø 2.5 mm Ø 0.098 in	
	Flexible with insulated ferrule	0.22 ... 1.5 mm <sup>2</sup>				
	Gauge	A1-B1		Torque 	0.5 Nm ± 0.1 3.43 lb.in ± 0.885	
2 conductors per clamp	Rigid: Solid/Stranded	0.2 ... 0.75 mm <sup>2</sup>				
	Flexible without ferrule	0.22 ... 0.75 mm <sup>2</sup>				
	Flexible with twin ferrule	0.22 ... 0.75 mm <sup>2</sup>				
Rated current / Rated cross section		16 A / 1.5 mm <sup>2</sup>				
Rated short-time withstand current (1s)		180 A				
Rated voltage		1000 V				
Impulse withstand voltage		8000 V				
Protection		IP20	NEMA 1			

The connecting capacity data for one Rigid: Solid/Stranded, or one Flexible conductor (when applicable) is a mandatory information required by IEC, UL and CSA standards (Copper conductors). All other data are provided as supplementary information only. For more details, please consult our CB, UL or CSA certificates and technical datasheet available on <http://www.TE.com>

Material specifications		Insulating material	Polyamide	
Flammability		NF F 16 101	V0	
Ambient temperature min/max		Service IEC 60068-2-1	-55 ... +110 °C	-67 ... +230 °F
		Storage	-55 ... +110 °C	-67 ... +230 °F
		Installing	-5 ... +40 °C	+23 ... +104 °F

All the main technical data provided are "manufacturer" values



### Ordering details

#### Test connectors for 5.2 mm 0.205 in spacing terminal blocks

Description	Color	Type	Part Number	Pkg qty	Weight (1 pce) g
Test connectors 5.2 mm 0.205 in spacing	Dark grey	TC5	1SNK900200R0000	10	5.20
End module, 5.2 mm 0.205 in		TC5-R1	1SNK900201R0000	10	5.20

### Ordering details

#### Test connectors for 6 mm 0.236 in spacing terminal blocks

Description	Color	Type	Part Number	Pkg qty	Weight (1 pce) g
Test connectors End module, 5.2 mm 0.205 in	Dark grey	TC5-R1	1SNK900201R0000	10	5.20
Spacers 0.8 mm 0.031 in spacing		ES-TC6	1SNK900105R0000	10	0.80

### Ordering details

#### Test connectors for 8 mm 0.315 in spacing terminal blocks

Description	Color	Type	Part Number	Pkg qty	Weight (1 pce) g
Test connectors 5.2 mm 0.205 in spacing	Dark grey	TC5	1SNK900200R0000	10	5.20
End module, 5.2 mm 0.205 in		TC5-R1	1SNK900201R0000	10	5.20
Spacers 2.8 mm 0.110 in spacing		ES-TC8	1SNK900104R0000	10	1.40

### Accessories

Description	Color	Type	Part Number	Pkg qty	Weight (1 pce) g
Cable clamps	Dark grey	PT-3	1SNK900625R0000	20	1.00
Terminal block markers	White	MG-CPM 13 41790	1SNB041790R0512	1960	0.23
		MC512	1SNK140000R0000	22	9.00
		MC512PA	1SNK149999R0000	20	10.00
Universal wire markers holder	Grey	UMH	1SNK900611R0000	10	0.20

Technical data valid for copper conductors only.

## Component plugs

### Common terminal block accessories

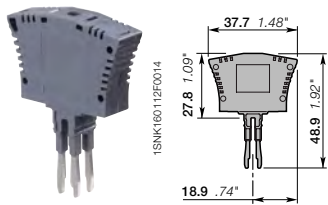

#### PG5

9.95 mm 0.392 in spacing

#### Mounting instructions

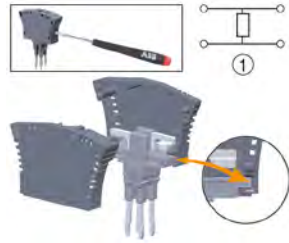

- Open the PG5-R2 with a flat screw-driver DIA . 3.5 mm 0.138 in,
- Use a soldering iron to fix your component,
- Close the PG5-R2,
- Plug-in in the terminal blocks jumper channels.

## PG5-R2 component plugs

#### Description

- Component holder compatible with 5.2 mm 0.205 in spacing ZS4 feed-through terminal blocks,
- Fit components 16 x 16 x 8.5 mm 0.630 x 0.630 x 0.335 in (not supplied with plug) such as resistors, diodes, varistance,
- Direct plug-in into the terminal blocks jumper channels,
- Maximum dissipated power: 2 W.

#### Ordering details

Description	Color	Type	Part Number	Pkg qty	Weight (1 pce) g
Components insertion between 2 blocks	Dark grey <input checked="" type="checkbox"/>	PG5-R2	1SNK900403R0000	20	8.00

#### Main technical data

Material specifications	Insulating material	Polyamide			
	Flammability	V0			
	NF F 16 101	I2F2			
Ambient temperature min/max	Service IEC 60068-2-1	-55 ... +110 °C	-67 ... +230 °F		
	Storage	-55 ... +110 °C	-67 ... +230 °F		
	Installing	-5 ... +40 °C	+23 ... +104 °F		
		IEC	UL - CSA		
Rated current					
Rated voltage		250 V			
Impulse withstand voltage		4000 V			
Protection		IP20	NEMA 1		

All the main technical data provided are "manufacturer" values

	RoHS				
	RoHS				

#### Accessories

Description	Color	Type	Part Number	Pkg qty	Weight (1 pce) g	
Terminal block markers	White <input type="checkbox"/>	MG-CPM 13 41790	1SNB041790R0512	1960	0.23	
Blank card		In polycarbonate	MC512	1SNK140000R0000	22	9.00
		Blank card	MC512PA	1SNK149999R0000	20	10.00
Universal wire markers holder	Grey <input type="checkbox"/>	UMH	1SNK900611R0000	10	0.20	

Technical data valid for copper conductors only.

## Component plugs

### Common terminal block accessories

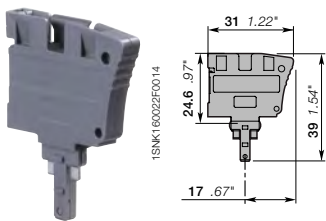

PG5

5.2 mm 0.205 in spacing

#### Mounting instructions



– Direct plug-in in disconnect with plug terminal block

## PG5 component plugs

#### Description

- Ease the components installation ( components not supplied with plug ) with our quick plug-in mounting system which avoids soldering process,
- Accept 8.8 x 3.2 mm 0.346 x 0.125 in components such as resistors, diodes or subminiature fuses (fully encapsulated),
- Maximum dissipated power: 1 W.

#### Ordering details

Description	Color	Type	Part Number	Pkg qty	Weight (1 pce)
Components in series with circuit	Dark grey <input checked="" type="checkbox"/>	PG5	1SNK900401R0000	20	3.50

#### Main technical data

Material specifications	Insulating material	Polyamide	
	Flammability	V0	
	NF F 16 101	I2F2	
Ambient temperature min/max	Service IEC 60068-2-1	-55 ... +110 °C	-67 ... +230 °F
	Storage	-55 ... +110 °C	-67 ... +230 °F
	Installing	-5 ... +40 °C	+23 ... +104 °F
		IEC	UL - CSA
Rated current	400 V		150 V
Rated voltage	6000 V		
Impulse withstand voltage	IP20		NEMA 1
Protection			

All the main technical data provided are "manufacturer" values

RoHS

#### Accessories

Description	Color	Type	Part Number	Pkg qty	Weight (1 pce)
Terminal block markers	White <input type="checkbox"/>	MG-CPM 13 41790	1SNB041790R0512	1960	0.23
Blank card	In polycarbonate	MC512	1SNK140000R0000	22	9.00
		MC512PA	1SNK149999R0000	20	10.00
Universal wire markers holder	Grey <input type="checkbox"/>	UMH	1SNK900611R0000	10	0.20

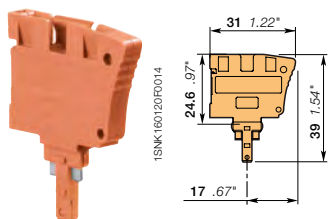

PG5

5.2 mm 0.205 in spacing

#### Mounting instructions



- PG5-R1 totally inserted: closed circuit,
- PG5-R1 inserted in central position: open circuit, plug secured in isolated central position

## PG5-R1 disconnect plugs

#### Description

Allow disconnect function when associated with the disconnect with plug terminal blocks.

#### Ordering details

Description	Color	Type	Part Number	Pkg qty	Weight (1 pce)
Equipped with linking bar	Orange <input checked="" type="checkbox"/>	PG5-R1	1SNK900402R0000	20	3.50

#### Main technical data

Material specifications	Insulating material	Polyamide	
	Flammability	V0	
	NF F 16 101	I2F3	
Ambient temperature min/max	Service IEC 60068-2-1	-55 ... +110 °C	-67 ... +230 °F
	Storage	-55 ... +110 °C	-67 ... +230 °F
	Installing	-5 ... +40 °C	+23 ... +104 °F
		IEC	UL - CSA
Rated current	18 A		20 A
Rated voltage	400 V		150 V
Impulse withstand voltage	6000 V		
Protection	IP20		NEMA 1

All the main technical data provided are "manufacturer" values

RoHS

#### Accessories

Description	Color	Type	Part Number	Pkg qty	Weight (1 pce)
Terminal block markers	White <input type="checkbox"/>	MG-CPM 13 41790	1SNB041790R0512	1960	0.23
Blank card	In polycarbonate	MC512	1SNK140000R0000	22	9.00
		MC512PA	1SNK149999R0000	20	10.00
Universal wire markers holder	Grey <input type="checkbox"/>	UMH	1SNK900611R0000	10	0.20

Technical data valid for copper conductors only.

## Tools

### Common terminal block accessories



TO

1SNK1600242F0014

## TO screwdrivers

### Description

Flat head screwdriver

### Ordering details

Description	Color	Type	Part Number	Pkg qty	Weight (1 pce) g
Insulated screwdriver 1000V IEC dimensions 3.5 x 100 mm 0.138 x 3.94 in		TO3.5-100-INS	1SNK900644R0000	1	37.00
screwdriver 3.5 x 50 mm 0.138 x 1.97 in		TO3.5-50	1SNK900640R0000	12	22.00
screwdriver 3.5 x 50 mm 0.138 x 1.97 in Angled 60°		TO3.5-50-A	1SNK900659R0000	12	21.6
screwdriver 4 x 100 mm 0.157 x 3.94 in		TO4-100	1SNK900641R0000	1	42.00
screwdriver 5.5 x 125 mm 0.216 x 4.92 in		TO5.5-125	1SNK900642R0000	1	75.50
screwdriver 6.5 x 150 mm 0.256 x 5.90 in		TO6.5-150	1SNK900643R0000	1	121.00



PS

1SNK160127F0014

## PS crimping tools

### Description

- Crimp flexible conductors equipped with ferrules from 0.08 to 10 mm<sup>2</sup> 28 AWG to 7 AWG,
- Semi-automatic crimping tool.

### Ordering details

Description	Color	Type	Part Number	Pkg qty	Weight (1 pce) g
180 mm 7.09 in length		PS-3	1SNK900650R0000	1	380.00

Technical data valid for copper conductors only.



## End sections

### PI-Spring terminal block accessories



1SNK160233V0014

EK2.5

### EK2.5 end sections

#### Description

- Unique dark grey color that fits all terminal blocks colours and ease the identification of circuits within your terminal block assemblies,
- Compatible with ZK2.5, ZK2.5-PE, ZK4, ZK4-PE, ZK6 and ZK6-PE PI-Spring screwless terminal blocks.

#### Ordering details

Description	Color	Type	Part Number	Pkg qty	Weight (1 pce) g
2 mm 0.079 in spacing	Dark grey	EK2.5	1SNK705910R0000	20	1.80



1SNK160233V0014

EK2.5-3P

### EK2.5-3P end sections

#### Description

- Unique dark grey color that fits all terminal blocks colours and ease the identification of circuits within your terminal block assemblies,
- Compatible with ZK2.5-3P, ZK2.5-PE-3P, ZK4-3P, ZK4-PE-3P, ZK2.5-S..., ZK2.5-SP and ZK2.5-SF... PI-Spring screwless terminal blocks.

#### Ordering details

Description	Color	Type	Part Number	Pkg qty	Weight (1 pce) g
2 mm 0.079 in spacing	Dark grey	EK2.5-3P	1SNK705911R0000	20	2.40



1SNK160233V0014

EK2.5-4P

### EK2.5-4P end sections

#### Description

- Unique dark grey color that fits all terminal blocks colours and ease the identification of circuits within your terminal block assemblies,
- Compatible with ZK2.5-4P, ZK2.5-PE-4P, ZK4-4P and ZK4-PE-4P PI-Spring screwless terminal blocks.

#### Ordering details

Description	Color	Type	Part Number	Pkg qty	Weight (1 pce) g
2 mm 0.079 in spacing	Dark grey	EK2.5-4P	1SNK705912R0000	20	2.70

### Main technical data

Material specifications	Insulating material	Polyamide			
	Flammability	V0			
	NF F 16 101	I2F2			
Ambient temperature min/max	Service IEC 60068-2-1	-55 ... +110 °C	-67 ... +230 °F		
	Storage	-55 ... +110 °C	-67 ... +230 °F		
	Installing	-5 ... +40 °C	+23 ... +104 °F		

All the main technical data provided are "manufacturer" values.

	RoHS				
	RoHS				

Technical data valid for copper conductors only.

1SNK160064S0201

## End sections

### PI-Spring terminal block accessories



1SNK160339V0014

EK2.5-S-4P

### EK2.5-S-4P end sections

#### Description

- Unique dark grey color that fits all terminal blocks colours and ease the identification of circuits within your terminal block assemblies,
- Compatible with ZK2.5-S-4P, ZK2.5-SP-4P, ZK2.5-CH-4P... PI-Spring screwless terminal blocks.

#### Ordering details

Description	Color	Type	Part Number	Pkg qty	Weight (1 pce) g
2 mm 0.079 in spacing	Dark grey	EK2.5-S-4P	1SNK705913R0000	20	2.94

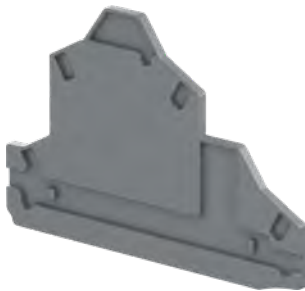

1SNK160237V0014

EK2.5-D2

### EK2.5-D2 end sections

#### Description

- Compatible with ZK2.5-D2, ZK2.5-D2-PE, ZK2.5-D1 and ZK2.5-D1-PE PI-Spring screwless terminal blocks.

#### Ordering details

Description	Color	Type	Part Number	Pkg qty	Weight (1 pce) g
2 mm 0.079 in spacing	Dark grey	EK2.5-D2	1SNK705960R0000	20	3.40



1SNK160346V0014

EK2.5-T3

### EK2.5-T3 end sections

#### Description

- Compatible with ZK2.5-T3, ZK2.5-T1, ZK2.5-T1-PE, ZK2.5-L-L-PE and ZK2.5-L-N-PE PI-Spring screwless terminal blocks.

#### Ordering details

Description	Color	Type	Part Number	Pkg qty	Weight (1 pce) g
0.8 mm 0.031 in spacing	Dark grey	EK2.5-T3	1SNK705961R0000	20	4.76

### Main technical data

Material specifications	Insulating material	Polyamide			
	Flammability	V0			
	NF F 16 101	I2F2			
Ambient temperature min/max	Service IEC 60068-2-1	-55 ... +110 °C	-67 ... +230 °F		
	Storage	-55 ... +110 °C	-67 ... +230 °F		
	Installing	-5 ... +40 °C	+23 ... +104 °F		

All the main technical data provided are "manufacturer" values.

	RoHS								
	RoHS								

Technical data valid for copper conductors only.

## End sections

### PI-Spring terminal block accessories



1SNK160238W0014

EK6-3P

### EK6-3P end sections

#### Description

– Compatible with ZK6-3P and ZK6-PE-3P PI-Spring screwless terminal blocks.

#### Ordering details

Description	Color	Type	Part Number	Pkg qty	Weight (1 pce) g
2 mm 0.079 in spacing	Dark grey	EK6-3P	1SNK708911R0000	20	2.80



1SNK160238W0014

EK10

### EK10 end sections

#### Description

– Compatible with ZK10, ZK10-PE, ZK16 and ZK16-PE PI-Spring screwless terminal blocks.

#### Ordering details

Description	Color	Type	Part Number	Pkg qty	Weight (1 pce) g
2 mm 0.079 in spacing	Dark grey	EK10	1SNK710910R0000	20	3.30



1SNK160318W0014

EK10-3P

### EK10-3P end sections

#### Description

– Unique dark grey color that fits all terminal blocks colours and ease the identification of circuits within your terminal block assemblies,  
– Compatible with ZK10-3P, ZK10-PE-3P, ZK16-3P, ZK16-PE-3P... PI-Spring screwless terminal blocks.

#### Ordering details

Description	Color	Type	Part Number	Pkg qty	Weight (1 pce) g
2 mm 0.079 in spacing	Dark grey	EK10-3P	1SNK710911R0000	20	4.5

### Main technical data

Material specifications	Insulating material	Polyamide			
	Flammability	V0			
	NF F 16 101	I2F2			
Ambient temperature min/max	Service IEC 60068-2-1	-55 ... +110 °C	-67 ... +230 °F		
	Storage	-55 ... +110 °C	-67 ... +230 °F		
	Installing	-5 ... +40 °C	+23 ... +104 °F		

All the main technical data provided are "manufacturer" values.

RoHS					
RoHS					

Technical data valid for copper conductors only.

1SNK160095S0201

# Circuit separators

## PI-Spring terminal blocks accessories



1SNK160240014

CS-R2

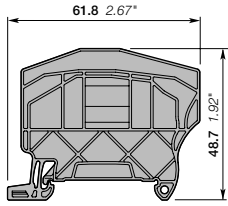

3 mm 0.118 in spacing

## CS-R2 circuit separators

### Description

- Compact circuits separator solution (only 3mm spacing) which provides a convenient visual identification of the several circuits within terminal assemblies,
- Unique top marking possibility that can replace the conventional solution of "end stop with label holder" for demanding applications with high space constraints, - Compatible with all PI-spring feed-through and ground terminal blocks up to 8 mm spacing,
- Mounting on DIN3-TH35 rail.

### Ordering details

Description	Color	Type	Part Number	Pkg qty	Weight (1 pce) g
3 mm 0.118 in spacing	Dark grey <input checked="" type="checkbox"/>	CS-R2	1SNK900106R0000	20	3.80

### Main technical data

Material specifications	Insulating material	Polyamide			
	Flammability	V0			
	NF F 16 101	I2F2			
Ambient temperature min/max	Service IEC 60068-2-1	-55 ... +110 °C	-67 ... +230 °F		
	Storage	-55 ... +110 °C	-67 ... +230 °F		
	Installing	-5 ... +40 °C	+23 ... +104 °F		

All the main technical data provided are "manufacturer" values

	<b>RoHS</b>				
	RoHS				

### Accessories

Description	Color	Type	Part Number	Pkg qty	Weight (1 pce) g
Terminal block markers	White <input type="checkbox"/>	MG-CPM 13 41791	1SNB041791R0612	1680	0.27
Labels	Yellow <input checked="" type="checkbox"/>	MG-VYT 46415	1SNB046415R0615	5250	0.04
	White <input type="checkbox"/>	MG-VYT 46915	1SNB046915R0615	5250	0.05
Blank card	In polycarbonate				
	Blank card		MC612	1SNK15000R0000	22
Universal wire markers holder	Grey <input type="checkbox"/>	UMH	1SNK900611R0000	10	0.20

Technical data valid for copper conductors only.



1SNK160241V0014

CS-R3

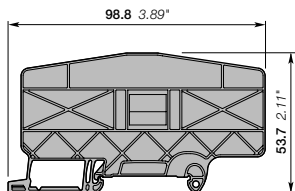

3 mm 0.118 in spacing

## CS-R3 circuit separators

### Description

- Compact circuits separator solution (only 3mm spacing) which provides a convenient visual identification of the several circuits within terminal assemblies,
- Unique top marking possibility that can replace the conventional solution of "end stop with label holder" for demanding applications with high space constraints,
- Compatible with all single deck PI-spring terminal blocks and ZS10-ST...terminal blocks ,
- Mounting on DIN3-TH35 rail.

### Ordering details

Description	Color	Type	Part Number	Pkg qty	Weight (1 pce) g
3 mm 0.118 in spacing	Dark grey <input checked="" type="checkbox"/>	CS-R3	1SNK900107R0000	20	6.40

### Main technical data

Material specifications	Insulating material	Polyamide			
	Flammability	V0			
	NF F 16 101	I2F2			
Ambient temperature min/max	Service IEC 60068-2-1	-55 ... +110 °C	-67 ... +230 °F		
	Storage	-55 ... +110 °C	-67 ... +230 °F		
	Installing	-5 ... +40 °C	+23 ... +104 °F		

All the main technical data provided are "manufacturer" values

RoHS <input checked="" type="checkbox"/>										
--	--	--	--	--	--	--	--	--	--	--

### Accessories

Description	Color	Type	Part Number	Pkg qty	Weight (1 pce) g	
Terminal block markers	White <input type="checkbox"/>	MG-CPM 13 41790	1SNB041790R0512	1960	0.23	
		MG-CPM 13 41791	1SNB041791R0612	1680	0.27	
Labels	Yellow <input checked="" type="checkbox"/>	MG-VYT 46415	1SNB046415R0615	5250	0.04	
	White <input type="checkbox"/>	MG-VYT 46915	1SNB046915R0615	5250	0.05	
Blank card	White <input type="checkbox"/>	In polycarbonate	MC512	1SNK140000R0000	22	9.00
		Blank card	MC512PA	1SNK149999R0000	20	10.00
		In polycarbonate	MC612	1SNK150000R0000	22	10.00
		Blank card	MC612PA	1SNK159999R0000	20	11.00
Universal wire markers holder 5.2 mm 0.205 in spacing	Grey <input type="checkbox"/>	UMH	1SNK900611R0000	10	0.20	

Technical data valid for copper conductors only.



## Shield connectors

### PI-Spring terminal block accessories



SHBP/SHB

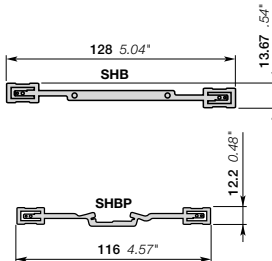

## SHBP/SHB shield connectors for PI-Spring terminal blocks

### Description

- Ensure the continuity of your shield connection,
- Various connection solutions available: RILS cable ties, soldering, quick-connect.

### Ordering details

Description	Color	Type	Part Number	Pkg qty	Weight (1 pce) g
Compatible with ZK2.5 and ZK2.5-S terminal blocks		SHBP	1SNK900601R0000	20	4.10
Compatible with ZS and ZK double deck terminal blocks:		SHB	1SNK900602R0000	20	4.90

### Main technical data

Material specifications	Insulating material				
	Flammability				
Ambient temperature min/max	NF F 16 101				
	Service IEC 60068-2-1	-55 ... +110 °C	-67 ... +230 °F		
	Storage	-55 ... +110 °C	-67 ... +230 °F		
	Installing	-5 ... +40 °C	+23 ... +104 °F		

SHBP	IEC	UL - CSA	Ex e
Rated voltage	100 V		50 V

All the main technical data provided are "manufacturer" values

	RoHS								
	RoHS								

### Accessories for screw clamp and PI-Spring terminal blocks

Description	Color	Type	Part Number	Pkg qty	Weight (1 pce) g
Cable ties	For SNK shield connector	RILS	1SNK900627R0000	10	0.30

### Mounting instructions



- SHBS is directly fixed on the terminal block,
- SHB is fixed on the ES4-D2 end section,
- SHBP is directly fixed on the terminal block,
- Connect the cable shielding on the shielding connector with:
  - RILS cable ties,
  - quick-connect (the shield connector needs to be prepared),
  - soldering iron.

Technical data valid for copper conductors only.

## End sections

### Screw clamp terminal block accessories



1SNK161019R0014

ES4

## ES4 end sections

### Description

- Unique dark grey color that fits all terminal blocks colours and ease the identification of circuits within your terminal block assemblies,
- Compatible with feed-through, ground and disconnect screw clamp terminal blocks.

### Ordering details

Description	Color	Type	Part Number	Pkg qty	Weight (1 pce) g
2.2 mm 0.087 in spacing	Dark grey	ES4	1SNK505910R0000	20	2.20



1SNK160229W0014

ES6-3S

## ES6-3S end sections

### Description

- Compatible with ZS6-3S and ZS6-3S-PE terminal blocks.

### Ordering details

Description	Color	Type	Part Number	Pkg qty	Weight (1 pce) g
2.2 mm 0.087 in spacing	Dark grey	ES6-3S	1SNK505912R0000	20	2.50



1SNK160230V0014

ES6-4S

## ES6-4S end sections

### Description

- Compatible with ZS6-4S, ZS6-4S-PE, ZS6-S-4S-T2 and ZS4-PE-R2 terminal blocks.

### Ordering details

Description	Color	Type	Part Number	Pkg qty	Weight (1 pce) g
2.2 mm 0.087 in spacing	Dark grey	ES6-4S	1SNK505911R0000	20	3.10



1SNK161012F0014

ES4-D2

## ES4-D2 end sections

### Description

- Unique dark grey color that fits all terminal blocks colours and ease the identification of circuits within your terminal block assemblies,
- Compatible with double deck screw clamp terminal blocks

### Ordering details

Description	Color	Type	Part Number	Pkg qty	Weight (1 pce) g
2.55 mm 0.100 in spacing	Dark grey	ES4-D2	1SNK505960R0000	20	4.10

### Main technical data

Material specifications	Insulating material	Polyamide			
	Flammability	V0			
	NF F 16 101	I2F2			
Ambient temperature min/max	Service IEC 60068-2-1	-55 ... +110 °C	-67 ... +230 °F		
	Storage	-55 ... +110 °C	-67 ... +230 °F		
	Installing	-5 ... +40 °C	+23 ... +104 °F		
All the main technical data provided are "manufacturer" values.					
	RoHS				
	RoHS				

Technical data valid for copper conductors only.

## End sections

### Screw clamp terminal block accessories



1SNK16023V0014

ES4-T3

### ES4-T3 end sections

#### Description

- Compatible with ZS4-T3 terminal block.

#### Ordering details

Description	Color	Type	Part Number	Pkg qty	Weight (1 pce) g
0.8 mm 0.031 in spacing	Dark grey	ES4-T3	1SNK505961R0000	20	4.20



1SNK161026F0014

ES4-SF

### ES4-SF end sections

#### Description

- Compatible with fuse ZS4-SF1... and disconnect screw clamp terminal blocks ZS4-S-R3.

#### Ordering details

Description	Color	Type	Part Number	Pkg qty	Weight (1 pce) g
1.5 mm 0.059 in spacing	Dark grey	ES4-SF	1SNK508960R0000	20	1.80



1SNK160231W0014

ES4-D2-SF1

### ES4-D2-SF1 end sections

#### Description

- Compatible with ZS4-D2-SF1 ... terminal blocks.

#### Ordering details

Description	Color	Type	Part Number	Pkg qty	Weight (1 pce) g
2.5 mm 0.098 in spacing	Dark grey	ES4-D2-SF1	1SNK508911R0000	20	5.00

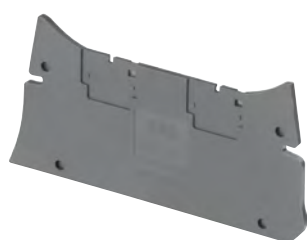

1SNK16102ZF0014

ES10-ST

### ES10-ST end sections

#### Description

- Unique dark grey color that fits all test disconnect terminal blocks ZS10-ST... and ease the identification of circuits within your terminal block assemblies,
- Also compatible with ZS10-R1 and ZS10-PE-R1.

#### Ordering details

Description	Color	Type	Part Number	Pkg qty	Weight (1 pce) g
2 mm 0.079 in spacing	Dark grey	ES10-ST	1SNK508910R0000	20	3.5

#### Accessories

Description	Color	Type	Part Number	Pkg qty	Weight (1 pce) g
Circuit separators	Dark grey	CS	1SNK900101R0000	20	0.20

#### Main technical data

Material specifications	Insulating material	Polyamide			
	Flammability	V0			
	NF F 16 101	I2F2			
Ambient temperature min/max	Service IEC 60068-2-1	-55 ... +110 °C	-67 ... +230 °F		
	Storage	-55 ... +110 °C	-67 ... +230 °F		
	Installing	-5 ... +40 °C	+23 ... +104 °F		

All the main technical data provided are "manufacturer" values.

	RoHS				
	RoHS				

Technical data valid for copper conductors only.

# Screw jumper bars

## Screw clamp terminal block accessories



1SNK1602 12F0014

**JB8**  
8 mm 0.315 in spacing

### Mounting instructions

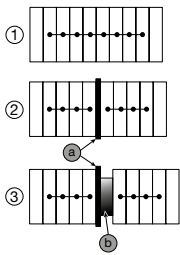

- 1 - Rated voltage: 160 V (IEC) / Not authorized (UL)
  - 2 - Rated voltage: 320 V (IEC) / Not authorized (UL)
  - 3 - Rated voltage: 1000 V (IEC) / 300 V (UL)
- a - End section ES10-ST  
b - End stop BAZ1

## JB8 jumper bars

### Description

Insulated jumper bar with screw mounting.

### Ordering details

Description		Color	Type	Part Number	Pkg qty	Weight (1 pce)
8 mm 0.315 in spacing	2 poles	Orange	JB8-2-R1	1SNK908902R0000	10	7.6
	3 poles		JB8-3-R1	1SNK908903R0000	10	11.6
	4 poles		JB8-4-R1	1SNK908904R0000	10	15.5
	5 poles		JB8-5-R1	1SNK908905R0000	10	19.4
	10 poles		JB8-10-R1	1SNK908910R0000	10	39.00

### Main technical data

<b>Material specifications</b>	Insulating material Flammability NF F 16 101	Polyamide V0 I2F3	Rail	
<b>Ambient temperature min/max</b>	Service IEC 60068-2-1	-55 ... +110 °C -67 ... +230 °F	Tool	Flat screwdriver Ø 3.5 mm Ø 0.138 in
	Storage	-55 ... +110 °C -67 ... +230 °F	Torque	0.7 Nm ± 0.1 6.2 lb.in ± 0.88
	Installing	-5 ... +40 °C +23 ... +104 °F		
<b>Rated current</b>		<b>IEC</b> 50 A	<b>UL - CSA</b> 51 A	<b>Ex e</b>
<b>Rated voltage</b>	Standard use	160 V		
	Alternated poles			Not authorized
<b>Impulse withstand voltage</b>				
<b>Protection</b>		IP20	NEMA 1	
All the main technical data provided are "manufacturer" values				
	<b>RoHS</b> RoHS			

Technical data valid for copper conductors only.

# Screw jumper bars

## Screw clamp terminal block accessories



1SNK16012AF0014

**JB16**  
16 mm 0.630 in spacing

### Mounting instructions



- With flat pliers, cut out the partitions on the terminal block insulating body. Be careful to not cut out the jumpered terminal blocks partitions at both ends of the assembly in order to maintain the IP20, Nema1 protection and insulation.
- Install the jumper bar with the recommended tool and torque.

## JB16 jumper bars

### Description

Insulated jumper bar with screw mounting.

### Ordering details

Description		Color	Type	Part Number	Pkg qty	Weight (1 pce) g
16 mm 0.630 in spacing	2 poles	Orange	JB16-2	1SNK916302R0000	10	10.00
	3 poles		JB16-3	1SNK916303R0000	10	16.00
	4 poles		JB16-4	1SNK916304R0000	10	22.00
	5 poles		JB16-5	1SNK916305R0000	10	28.00
	10 poles		JB16-10	1SNK916310R0000	10	56.60

### Main technical data

<b>Material specifications</b>	Insulating material	Polyamide		Rail	
	Flammability	V0		Tool	
	NF F 16 101	I2F3			
<b>Ambient temperature min/max</b>	Service IEC 60068-2-1	-55 ... +110 °C	-67 ... +230 °F	Torque	
	Storage	-55 ... +110 °C	-67 ... +230 °F		
	Installing	-5 ... +40 °C	+23 ... +104 °F		
<b>Rated current</b>		<b>IEC</b>	<b>UL - CSA</b>	<b>Ex e</b>	
<b>Rated voltage</b>	Standard use	125 A	150 A		
		1000 V	600 V		
	Alternated poles			Not authorized	
<b>Impulse withstand voltage</b>		8000 V			
<b>Protection</b>		IP20	NEMA 1		
All the main technical data provided are "manufacturer" values					
	<b>RoHS</b>				
	RoHS				

## JB22 jumper bars

### Description

Screw jumper bars



1SNK160100F0014

**JB22**  
22 mm 0.866 in spacing

### Mounting instructions



- With flat pliers, cut out the partitions on the terminal block insulating body. Be careful to not cut out the jumpered terminal blocks partitions at both ends of the assembly in order to maintain the IP20, Nema1 protection and insulation.
- Install the jumper bar with the recommended tool and torque.

### Ordering details

Description		Color	Type	Part Number	Pkg qty	Weight (1 pce) g
22 mm 0.866 in spacing	2 poles		JB22-2	1SNK922302R0000	5	27.00
	3 poles		JB22-3	1SNK922303R0000	5	43.30
	5 poles		JB22-5	1SNK922305R0000	5	76.10
	10 poles		JB22-10	1SNK922310R0000	5	157.40

### Main technical data

<b>Material specifications</b>	Insulating material	Polyamide		Rail	
	Flammability	V0		Tool	
	NF F 16 101	I2F3			
<b>Ambient temperature min/max</b>	Service IEC 60068-2-1	-55 ... +110 °C	-67 ... +230 °F	Torque	
	Storage	-55 ... +110 °C	-67 ... +230 °F		
	Installing	-5 ... +40 °C	+23 ... +104 °F		
<b>Rated current</b>		<b>IEC</b>	<b>UL - CSA</b>	<b>Ex e</b>	
<b>Rated voltage</b>	Standard use	192 A	175 A		
		1000 V	600 V	630 V	
	Alternated poles			Not authorized	
<b>Impulse withstand voltage</b>		8000 V			
<b>Protection</b>		IP20			
All the main technical data provided are "manufacturer" values					
	<b>RoHS</b>				
	RoHS				

Technical data valid for copper conductors only.



# Screw jumper bars

## Screw clamp terminal block accessories



1SNK160100F0014

**JB26**  
26 mm 1.024 in spacing

## JB26 jumper bars

### Description

Screw jumper bars

### Ordering details

Description		Color	Type	Part Number	Pkg qty	Weight (1 pce) g
26 mm 1.02 in spacing	2 poles		JB26-2	1SNK926302R0000	5	41.20
	3 poles		JB26-3	1SNK926303R0000	5	65.70
	5 poles		JB26-5	1SNK926305R0000	5	115.70
	10 poles		JB26-10	1SNK926310R0000	5	241.50

### Mounting instructions

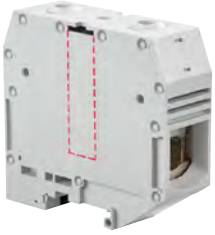

- With flat pliers, cut out the partitions on the terminal block insulating body. Be careful to not cut out the jumpered terminal blocks partitions at both ends of the assembly in order to maintain the IP20, Nema1 protection and insulation,
- Install the jumper bar with the recommended tool and torque.

### Main technical data

<b>Material specifications</b>	Insulating material			Rail		
	Flammability			Tool		Allen key Ø 4 mm Ø 0.157 in
	NF F 16 101			Torque		2 Nm ± 0.4 17.7 lb.in ± 3.54
<b>Ambient temperature min/max</b>	Service IEC 60068-2-1	-55 ... +110 °C	-67 ... +230 °F			
	Storage	-55 ... +110 °C	-67 ... +230 °F			
	Installing	-5 ... +40 °C	+23 ... +104 °F			
<b>Rated current</b>		IEC	UL - CSA	<b>Ex e</b>		
		232 A	230 A			
<b>Rated voltage</b>	Standard use	1000 V	600 V	630 V		
	Alternated poles			Not authorized		
<b>Impulse withstand voltage</b>		8000 V				
<b>Protection</b>		IP20				
All the main technical data provided are "manufacturer" values						
	<b>RoHS</b>					
	RoHS					

Technical data valid for copper conductors only.

## Screw jumper bars

### Screw clamp terminal block accessories



1SNK160100F0014

**BJMI31**

31 mm 1.22 in spacing

#### Mounting instructions



- With flat pliers, cut out the partitions on the terminal block insulating body. Be careful not to cut out the jumpered terminal blocks partitions at both ends of the assembly in order to maintain the IP20, Nema1 protection and insulation.
- Install the jumper bar with the recommended tool and torque.

## BJMI31 jumper bars

### Description

Screw jumper bars

### Ordering details

Description	Color	Type	Part Number	Pkg qty	Weight (1 pce) g
31mm 1.220 in spacing		2 poles	BJMI31.2	1	120.00
		3 poles	BJMI31.3	1	190.00

### Main technical data

<b>Material specifications</b>	Insulating material		Rail		
	Flammability		Tool		Allen key Ø 5 mm
	NF F 16 101				Ø 0.196 in 3 Nm ± 0.4 26.55 lb.in ± 3.54
<b>Ambient temperature min/max</b>	Service IEC 60068-2-1	-55 ... +110 °C	-67 ... +230 °F		
	Storage	-55 ... +110 °C	-67 ... +230 °F		
	Installing	-5 ... +40 °C	+23 ... +104 °F		
		<b>IEC</b>	<b>UL - CSA</b>	<b>Ex e</b>	
<b>Rated current</b>		309 A	445 A		
<b>Rated voltage</b>	Standard use	1000 V	600 V		
		Alternated poles		Not authorized	
<b>Impulse withstand voltage</b>		8000 V			
<b>Protection</b>		IP20			

All the main technical data provided are "manufacturer" values

	<b>RoHS</b>				
	RoHS				



1SNK160100F0014

**BJMI36**

36 mm 1.42 in spacing

#### Mounting instructions



- With flat pliers, cut out the partitions on the terminal block insulating body. Be careful not to cut out the jumpered terminal blocks partitions at both ends of the assembly in order to maintain the IP20, Nema1 protection and insulation.
- Install the jumper bar with the recommended tool and torque.

## BJMI36 jumper bars

### Description

Screw jumper bars

### Ordering details

Description	Color	Type	Part Number	Pkg qty	Weight (1 pce) g
36mm 1.417 in spacing		2 poles	BJMI36.2	1	170.00
		3 poles	BJMI36.3	1	260.00

### Main technical data

<b>Material specifications</b>	Insulating material		Rail		
	Flammability		Tool		Allen key Ø 5 mm
	NF F 16 101				Ø 0.196 in 3 Nm ± 0.4 26.55 lb.in ± 3.54
<b>Ambient temperature min/max</b>	Service IEC 60068-2-1	-55 ... +110 °C	-67 ... +230 °F		
	Storage	-55 ... +110 °C	-67 ... +230 °F		
	Installing	-5 ... +40 °C	+23 ... +104 °F		
		<b>IEC</b>	<b>UL - CSA</b>	<b>Ex e</b>	
<b>Rated current</b>		415 A	620 A		
<b>Rated voltage</b>	Standard use	1000 V	600 V		
		Alternated poles		Not authorized	
<b>Impulse withstand voltage</b>		8000 V			
<b>Protection</b>		IP20			

All the main technical data provided are "manufacturer" values

	<b>RoHS</b>				
	RoHS				

Technical data valid for copper conductors only.

## Lateral jumper bars

### Screw clamp terminal block accessories



1SNK160112PC014

PC8

8 mm 0.315 in spacing

#### Mounting instructions for ZS10-ST...

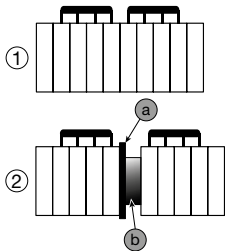

1 - Rated voltage: 630 V (IEC) / 150 V (UL)

2 - Rated voltage: 630 V (IEC) / 300 V (UL)

a - End section ES10-ST

b - End stop BAZ1

## PC8 lateral jumper bars

### Description

IP20 Comb jumper bars,

- direct insertion in the screw clamp before tightening the screws, above the eventual conductor (if conductor used with ferrule, we recommend the use of long ferrule for optimized mounting ergonomony with test disconnect terminal blocks),
- Multiple versions available in pre-cut poles for test disconnect terminal blocks applications.

### Ordering details

Description	Color	Type	Part Number	Pkg qty	Weight (1 pce) g
<b>Lateral jumper bars</b>					
8 mm 0.315 in spacing	Black ■	PC8-2	1SNA116538R1700	10	3.00
		PC8-3	1SNA116539R1000	10	4.00
		PC8-4	1SNA116540R2500	10	6.00
		PC8-10	1SNA163313R2400	10	14.00

### Lateral jumper bars pre-cut poles

Description	Color	Type	Part Number	Pkg qty	Weight (1 pce) g
<b>Lateral jumper bars pre-cut poles</b>					
8 mm 0.315 in spacing	Black ■	PC8-R1	1SNA400711R0600	10	6.60
		PC8-R2	1SNA400712R0700	10	7.80
		PC8-R3	1SNA400713R0000	10	9.00
		PC8-R4	1SNA400724R0300	10	4.50
		PC8-R5	1SNA400842R0000	10	6.60
		PC8-R6	1SNA400843R0000	10	6.60
		PC8-R7	1SNA400849R0000	10	6.60
		PC8-R8	1SNA400850R0000	10	7.80

### Main technical data

Material specifications	Insulating material	Polyamide			
	Flammability	V0			
	NF F 16 101	I2F3			
Ambient temperature min/max	Service IEC 60068-2-1	-55 ... +110 °C	-67 ... +230 °F		
	Storage	-55 ... +110 °C	-67 ... +230 °F		
	Installing	-5 ... +40 °C	+23 ... +104 °F		

All the main technical data provided are "manufacturer" values

RoHS  
RoHS



1SNK160537PC014

PC81

8 mm 0.315 in spacing

## PC81 lateral jumper bars

### Description

Comb-type jumper bar, allows the connection of consecutive blocks or not by one compression clamp connection.

### Ordering details

Description	Color	Type	Part Number	Pkg qty	Weight (1 pce) g
8 mm 0.315 in spacing	Grey □	PC81-10	1SNA173523R1100	10	5.00

### Main technical data

Material specifications	Insulating material	Brass/polyamide			
	Flammability	V0			
	NF F 16 101	I2F3			
Ambient temperature min/max	Service IEC 60068-2-1	-55 ... +110 °C	-67 ... +230 °F		
	Storage	-55 ... +110 °C	-67 ... +230 °F		
	Installing	-5 ... +40 °C	-23 ... +104 °F		

All the main technical data provided are "manufacturer" values

RoHS  
RoHS

Technical data valid for copper conductors only.

## Circuit separators

### Screw clamp terminal block accessories



1SNK160002R0014

CS  
0 mm 0 in spacing

#### Mounting instructions



## CS circuit separators

### Description

- The CS circuit separator avoids the derating of terminal blocks when cut jumper bars JB are used,
- Compatible with feed-through terminal blocks up to 16 mm<sup>2</sup> 4 AWG,
- Without spacing loss.

### Ordering details

Description	Color	Type	Part Number	Pkg qty	Weight (1 pce) g
0 mm 0 in spacing	Dark grey	CS	1SNK900101R0000	20	0.20

### Main technical data

Material specifications	Insulating material	Polyamide									
	Flammability	V0									
Ambient temperature min/max	NF F 16 101	I2F2									
	Service IEC 60068-2-1	-55 ... +110 °C	-67 ... +230 °F								
	Storage	-55 ... +110 °C	-67 ... +230 °F								
	Installing	-5 ... +40 °C	+23 ... +104 °F								
All the main technical data provided are "manufacturer" values											
<table border="1"> <tr> <td>RoHS</td> <td>RoHS</td> <td></td> <td></td> <td></td> <td></td> </tr> </table>						RoHS	RoHS				
RoHS	RoHS										



1SNK160003R0014

CS-R1

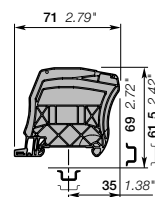

3 mm 0.118 in spacing

## CS-R1 circuit separators

### Description

- Ease the visual identification of the several circuits within your terminal block assemblies,
- Compatible with feed-through terminal blocks up to 35 mm<sup>2</sup> 0 AWG,
- Intermediate cover holder for CO protective cover,
- Mounting on DIN3-TH35 rail.

### Ordering details

Description	Color	Type	Part Number	Pkg qty	Weight (1 pce) g
3 mm 0.118 in spacing	Dark grey	CS-R1	1SNK900103R0000	20	5.20

### Main technical data

Material specifications	Insulating material	Polyamide									
	Flammability	V0									
Ambient temperature min/max	NF F 16 101	I2F2									
	Service IEC 60068-2-1	-55 ... +110 °C	-67 ... +230 °F								
	Storage	-55 ... +110 °C	-67 ... +230 °F								
	Installing	-5 ... +40 °C	+23 ... +104 °F								
All the main technical data provided are "manufacturer" values											
<table border="1"> <tr> <td>RoHS</td> <td>RoHS</td> <td></td> <td></td> <td></td> <td></td> </tr> </table>						RoHS	RoHS				
RoHS	RoHS										

#### Mounting instructions



### Accessories

Description	Color	Type	Part Number	Pkg qty	Weight (1 pce) g
Terminal block markers	White <input type="checkbox"/>	MG-CPM 13 41790	1SNB041790R0512	1960	0.23
Blank card		MC512	1SNK140000R0000	22	9.00
		MC512PA	1SNK149999R0000	20	10.00
Universal wire markers holder	Grey <input type="checkbox"/>	UMH	1SNK900611R0000	10	0.20

Technical data valid for copper conductors only.

## Shield connectors

### Screw clamp terminal block accessories



1SNK16014RF0014

SHBS/SHB

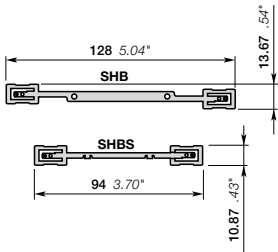

## SHBS/SHB shield connectors

### Description

- Ensure the continuity of your shield connection,
- Various connection solutions available: RILS cable ties, soldering, quick-connect.

### Ordering details

Description	Color	Type	Part Number	Pkg qty	Weight (1 pce) g
Compatible with ZS feed-through terminal blocks		SHBS	1SNK900600R0000	20	3.50
Compatible with ZS and ZK double deck terminal blocks		SHB	1SNK900602R0000	20	4.90

### Main technical data

Material specifications	Insulating material				
	Flammability				
Ambient temperature min/max	Service IEC 60068-2-1	-55 ... +110 °C	-67 ... +230 °F		
	Storage	-55 ... +110 °C	-67 ... +230 °F		
	Installing	-5 ... +40 °C	+23 ... +104 °F		

<b>SHBS</b>	<b>IEC</b>	<b>UL - CSA</b>	<b>Ex e</b>
<b>Rated voltage</b>	320 V		125 V

All the main technical data provided are "manufacturer" values

<b>RoHS</b>									
RoHS									

### Accessories for screw clamp and PI-Spring terminal blocks

Description	Color	Type	Part Number	Pkg qty	Weight (1 pce) g
Cable ties	For SNK shield connector	RILS	1SNK900627R0000	10	0.30

### Mounting instructions



- SHBS is directly fixed on the terminal block,
- SHB is fixed on the ES4-D2 end section,
- SHBP is directly fixed on the terminal block,
- Connect the cable shielding on the shielding connector with:
  - RILS cable ties,
  - quick-connect (the shield connector needs to be prepared),
  - soldering iron.

Technical data valid for copper conductors only.



# PL protecting covers

## Screw clamp terminal block accessories



1SNK16006R0014

PL

### Mounting instructions



- The mounting of the PL does not require a screwdriver,
- The dismounting of the PL requires a screwdriver DIA .4 mm 0.160 in, the screwdriver must be positioned in the cover centered hole.

### Description

- Prohibit access to the screw clamps,
- Indicate live circuits.

### Ordering details

Description	Color	Type	Part Number	Pkg qty	Weight (1 pce) g
5.2 mm 0.205 in spacing	Transparent <input checked="" type="checkbox"/>	PL5	1SNK900618R0000	10	1.50
6 mm 0.236 in spacing		PL6	1SNK900619R0000	10	1.80
8 mm 0.315 in spacing		PL8	1SNK900620R0000	10	2.60
10 mm 0.394 in spacing		PL10	1SNK900621R0000	10	3.10
16 mm 0.630 in spacing		PL16	1SNK900622R0000	10	4.60

### Main technical data

Material specifications	Insulating material	Polycarbonate	
	Flammability	V2	
Ambient temperature min/max	NF F 16 101		
	Service IEC 60068-2-1	-55 ... +110 °C	-67 ... +230 °F
	Storage	-55 ... +110 °C	-67 ... +230 °F
	Installing	-5 ... +40 °C	+23 ... +104 °F

### Mounting instructions

Tool		Flat screwdriver Ø 4 mm Ø 0.157 in
------	--	--

All the main technical data provided are "manufacturer" values

	<b>RoHS</b> RoHS																		
--	---------------------	--	--	--	--	--	--	--	--	--	--	--	--	--	--	--	--	--	--

Technical data valid for copper conductors only.

1SNK160021S0201

## Protecting covers

### Screw clamp terminal block accessories



1SNK160110FC0014

CO

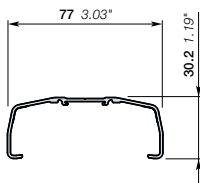

## CO protecting covers

### Description

- Restrict access to your assembly with the protecting cover CO installed with KCO mounting kit (2 end stops, 2 sealing accessories),
- Compatible with SNK feed-through terminal blocks up to 35 mm<sup>2</sup> 0 AWG.

### Ordering details

Description	Color	Type	Part Number	Pkg qty	Weight (1 pce)
1 m 39.4 in length	Transparent <input checked="" type="checkbox"/>	CO	1SNK900604R0000	1	300.00

### Main technical data

Material specifications	Insulating material	PVC			
	Flammability	V0			
Ambient temperature min/max	Service IEC 60068-2-1	-55 ... +80 °C	-67 ... +176 °F		
	Storage	-55 ... +80 °C	-67 ... +176 °F		
	Installing	-5 ... +40 °C	+23 ... +104 °F		

All the main technical data provided are "manufacturer" values

RoHS  
RoHS

### Accessories

Description	Color	Type	Part Number	Pkg qty	Weight (1 pce)
Protecting cover kits	Dark grey <input checked="" type="checkbox"/>	KCO	1SNK900624R0000	1	47.80
Label	White <input type="checkbox"/>	PAM43020	1SNA235106R2600	20	27.00

### Mounting instructions



- Restrict access to the circuit by sealing the cover:
- Drill on the CO center line at 5 mm 0.197 in from the extremity with 5 mm 0.197 in diameter drill,
  - Pass the sealing collar through the CO and KCO holes.



1SNK160144F0014

KCO

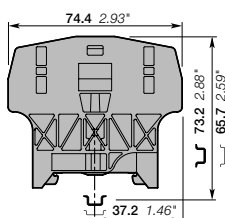

## KCO protecting cover kits

### Description

Mount your protecting cover with the KCO versatile mounting kit (2 end stops, 2 sealing accessories):

- Maintain the cover,
- Reliably seal the access to the terminal assembly if needed,
- Use it as well as an end stop.

### Ordering details

Description	Color	Type	Part Number	Pkg qty	Weight (1 pce)
Mounting kit for cover CO	Dark grey <input checked="" type="checkbox"/>	KCO	1SNK900624R0000	1	47.80

### Main technical data

Material specifications	Insulating material	Polyamide		Rail	G32, TH 35-7.5, TH 35-15, TH 15-5.5
	Flammability	V0		Tool	Flat screwdriver Ø 4 mm Ø 0.157 in
Ambient temperature min/max	Service IEC 60068-2-1	-55 ... +110 °C	-67 ... +230 °F		
	Storage	-55 ... +110 °C	-67 ... +230 °F		
	Installing	-5 ... +40 °C	+23 ... +104 °F		

All the main technical data provided are "manufacturer" values

RoHS  
RoHS

Technical data valid for copper conductors only.

## Short circuit bridges

### Screw clamp terminal block accessories



SC-JB8

8 mm 0.315 in spacing



1SNK160231R0014

## SC-JB8 short circuit bridges

### Description

- Allow safe short-circuiting of current Transformers circuits,
- Insulated,
- Fully operated by screwdriver,
- Short circuited fixed position secured thanks to AJS9 tightening,
- Adapted hook shape maintains the bridge on the terminal block in the non short-circuited position,
- The orange version can be used as fixed jumpers.

### Ordering details

Description		Color	Type	Part Number	Pkg qty	Weight (1 pce) g
8 mm 0.315 in spacing	2 poles	Yellow 	SC-JB8-2	1SNK900652R0000	25	2.00
	3 poles		SC-JB8-3	1SNK900653R0000	25	3.4
	4 poles		SC-JB8-4	1SNK900654R0000	25	4.7
	3/5 poles		SC-JB8-5	1SNK900655R0000	25	4.7
	3 poles		Orange 	SC-JB8-3-OR	1SNK900657R0000	25
	4 poles	SC-JB8-4-OR		1SNK900658R0000	25	

### Main technical data

<b>Material specifications</b>	Insulating material	Polyamide	
	Flammability	V0	
	NF F 16 101	I2F3	
<b>Ambient temperature min/max</b>	Service IEC 60068-2-1	-55 ... +110 °C	-67 ... +230 °F
	Storage	-55 ... +110 °C	-67 ... +230 °F
	Installing	-5 ... +40 °C	+23 ... +104 °F

All the main technical data provided are "manufacturer" values

	<b>RoHS</b>																		
	RoHS																		

Technical data valid for copper conductors only.



## End sections

### Pluggable terminal block accessories



1SNK805910R0000

EDK2.5-22

## EDK2.5-22 end sections

### Description

– Compatible with ZDK2.5-22 and ZDK4-22 pluggable terminal blocks.

Description	Color	Type	Part Number	Pkg qty	Weight 1 pce g
2.2 mm 0.087 in spacing	Dark grey	■ EDK2.5-22	1SNK805910R0000	20	3.08



1SNK805914R0000

EDK2.5-21

## EDK2.5-21 end sections

### Description

– Compatible with ZDK2.5-11, ZDK2.5-11-BL and ZDK2.5-11-PE pluggable terminal blocks.

Description	Color	Type	Part Number	Pkg qty	Weight 1 pce g
1.5 mm 0.059 in spacing	Dark grey	■ EDK2.5-21	1SNK805914R0000	20	1.90



1SNK805915R0000

EDK2.5-11

## EDK2.5-11 end sections

### Description

– Compatible with ZDK2.5-11 pluggable terminal blocks.

Description	Color	Type	Part Number	Pkg qty	Weight 1 pce g
1.5 mm 0.059 in spacing	Dark grey	■ EDK2.5-11	1SNK805915R0000	20	1.49



1SNK805913R0000

EDK2.5-D

## EDK2.5-D end sections

### Description

– Compatible with ZDK2.5-D2, ZDK2.5-D2-BL, ZDK2.5-D1, ZDK2.5-D1-PE and ZDK2.5-D2-PE pluggable terminal blocks.

Description	Color	Type	Part Number	Pkg qty	Weight 1 pce g
2 mm 0.079 in spacing	Dark grey	■ EDK2.5-D	1SNK805913R0000	20	3.88

### Main technical data

Material specifications	Insulating material	Polyamide		
	Flammability	V0		
	NF F 16 101	I2F2		
Ambient temperature min/max	Service IEC 60068-2-1	-55 ... +110 °C	-67 ... +230 °C	
	Storage	-55 ... +110 °C	-67 ... +230 °C	
	Installing	-5 ... +40 °C	+23 ... +104 °C	

All the main technical data provided are "manufacturer" values.

RoHS  
RoHS

Technical data valid for copper conductors only.



## End sections

### Pluggable terminal block accessories



1SNK164028W0014

## ED2.5-22 end sections

### Description

– Compatible with ZD2.5-22 and ZD2.5-22-PE pluggable terminal blocks.

### Ordering details

Description	Color	Type	Part Number	Pkg qty	Weight (1 pce) g
2 mm 0.079 in spacing	Dark grey 	ED2.5-22	1SNK805917R0000	20	3.64

ED2.5-22



1SNK163020W0014

## EDS4-22 end sections

### Description

– Compatible with ZDS4-22 pluggable terminal block.

### Ordering details

Description	Color	Type	Part Number	Pkg qty	Weight (1 pce) g
0.8 mm 0.031 in spacing	Dark grey 	EDS4-22	1SNK805911R0000	20	1.85

EDS4-22

### Main technical data

Material specifications	Insulating material	Polyamide	
	Flammability	V0	
	NF F 16 101	I2F2	
Ambient temperature min/max	Service IEC 60068-2-1	-55 ... +110 °C	-67 ... +230 °C
	Storage	-55 ... +110 °C	-67 ... +230 °C
	Installing	-5 ... +40 °C	+23 ... +104 °C

All the main technical data provided are "manufacturer" values.

RoHS																			
RoHS																			

Technical data valid for copper conductors only.

1SNK164034S0201

# Coding pegs - Locking devices

## Pluggable terminal block accessories



COP

### COP coding pegs

#### Description

– The coding pegs prevent plugs to be inserted into the wrong circuit.

#### Ordering details

Description	Color	Type	Part Number	Pkg qty	Weight (1 pce) g
	Dark grey ■	COP-ZD	1SNK900636R0000	10	3.57

#### Main technical data

Material specifications	Insulating material	Polyamide	
	Flammability	V0	
	NF F 16 101	I2F2	
Ambient temperature min/max	Service IEC 60068-2-1	-55 ... +110 °C	-67 ... +230 °F
	Storage	-55 ... +110 °C	-67 ... +230 °F
	Installing	-5 ... +40 °C	+23 ... +104 °F

All the main technical data provided are "manufacturer" values.

	RoHS								
	RoHS								

#### Mounting instructions

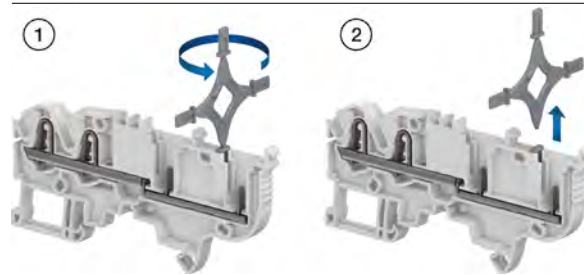

VR

9.4 mm 0.370 in spacing

### VR locking devices

#### Description

- Automatic locking providing excellent plug withstand in case of accidental pulling,
- Lock safely one or two CDK or CDS plugs on ZDK and ZDS pluggable terminal blocks,
- Install one VR... up to 8 poles plugs assembly and two VR... up to 15 poles assembly.

#### Ordering details

Description	Color	Type	Part Number	Pkg qty	Weight (1 pce) g
9.4 mm 0.370 in spacing	Black ■	VR-ZD	1SNK900637R0000	50	6.5

#### Main technical data

Material specifications	Insulating material	Polyacetal	
	Flammability	HB	
	NF F 16 101		
Ambient temperature min/max	Service IEC 60068-2-1	-55 ... +110 °C	-67 ... +230 °F
	Storage	-55 ... +110 °C	-67 ... +230 °F
	Installing	-5 ... +40 °C	+23 ... +104 °F

All the main technical data provided are "manufacturer" values.

	RoHS								
	RoHS								

#### Mounting instructions

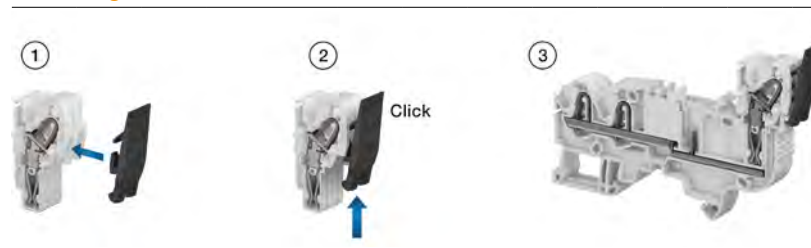

Technical data valid for copper conductors only.



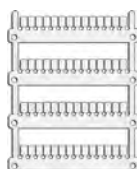

Selection guide	238-239
MG3 thermal transfer printer	240-241
AMS 600 and AMS 250 plotter	242-243

### Terminal block markers

5.2 mm 0.205 in spacing

<b>MC512, MG-CPM-13</b>	Blank card in polycarbonate	244
<b>MC512PA</b>	Blank card in polyamide	245
	Pre-printed marker card for horizontal terminal block assembly	246-247
	Pre-printed marker card for vertical terminal block assembly	248-249

6 mm 0.236 in spacing

<b>MC612, MG-CPM-13</b>	Blank card in polycarbonate	250
<b>MC612PA</b>	Blank card in polyamide	251
	Pre-printed marker card for horizontal terminal block assembly	252-253
	Pre-printed marker card for vertical terminal block assembly	254

8 mm 0.315 in spacing

<b>MC812, MC812PA</b>	Blank card	256
<b>MC812PA</b>	Pre-printed marker card for horizontal terminal block assembly	257-258
	Pre-printed marker card for vertical terminal block assembly	259-260

### Markers

<b>UMH</b>	Universal wire markers holder	261
<b>MG2-TDMO</b>	Clip-on blank wire marker	261
<b>MG-TAR, MG-TAA</b>	Markers for components	262
<b>MG-TAPW</b>	Markers for components	263
<b>MCLH</b>	Label	264

### Marking systems

<b>HTP500</b>	Consumable	265
<b>MG3</b>	Thermal transfer printer	266
<b>AMS</b>	Plotter	267-268

For versatile applications



<b>Marking systems</b>	<b>MG3</b>
<b>Technology</b>	Thermal transfer
<b>Printing mode</b>	Manual
<b>Printing speed</b>	Medium
<b>Printing quality</b>	300 x 600 dpi
<b>1 ribbon or ink cartridge printing capacity</b>	~ 160 000, MG-CPM (5 x 10 mm markers)
<b>Printing color available (monochrome)</b>	Black / Red / Blue / Green / White
<b>Terminal block markers material</b>	Polycarbonate
<b>Terminal block markers</b>	
SNK series terminal blocks blank markers polyamide	–
SNK series terminal blocks blank markers polycarbonate	MG-CPM
SNK series terminal blocks blank markers PVC	MG-CPMF
<b>End stop markers</b>	2 marker types
<b>Other terminal blocks manufacturers blank markers</b>	15 manufacturers
<b>Wires and cables markers</b>	4 marker types
<b>Components and equipment markers</b>	9 marker types



## For basic marking applications



### AMS 600 - AMS 250

Plotter

Manual

Low

300 x 300 dpi

~ 230 000 markers (with 3 characters per markers)

Black

Polyamide

MC...PA

–

–

4 marker types

5 manufacturers

1 marker type

9 marker types



## The versatile, compact and robust marking system

MARKINGenius® MG3 is a high resolution printer based on thermal transfer technology for producing high quality identification and labelling for terminal blocks, cables and all equipment mounted in electrical panels.

Compact, ergonomic, clean and quiet, MARKINGenius® MG3 may be conveniently located in an office or workshop or easily transported in the field.

Thermal transfer technology uses heat to transfer characters or symbols onto a plastic marker through an ink ribbon. Besides the excellent printing quality, there is no drying time and the markers are instantly usable.

With the MG3 thermal transfer printer, forget about drying times and clogged print head problems.

## Combined simplicity, performance and make savings

### Facilitate your printing process

**Compact design** (382 x 230 x 230 mm) facilitates use in workshops or in the field.

**Easy to install and use:** comprehensive quick-start kit. Intuitive software with easy data import and entry.

**Versatile:** many different media available: plastic markers, stickers, labels etc.

### Save time and consumables

#### Gain time with a short printing process:

12 seconds cycle. Carriage loading and unloading operation is fast and simple.

**Economic:** up to 300 000 markers with one ribbon. Partially printed marker card may be reused to avoid wastage.

**No drying time:** printed markers are immediately ready to use.

### Experience quality

**High Quality printing:** 300 x 600 dpi for image or graphic printing.

**Robust:** all moving parts are in metal.



High quality printing



Short printing cycle of 12 seconds



Economic: up to 300 000 markers with one ribbon



Many media types available for printing

## MG3 thermal transfer printer

### Components of the kit

The MG3 printer is delivered with a comprehensive set of accessories for getting started quickly

Kit (Part number: 1SNB419001R0000) including:

- 1 Thermal transfer printer
- 1 Software CD
- 1 Power supply cable
- 1 USB cable
- 1 Installation, operating, maintenance and user documentation
- 1 Protective cover
- 1 Ribbon take up spool
- 1 MG2-QTB support plate for terminal block markers (MG-CPM-01, 02, 03, 04, 07)
- 1 MG2-PWC support plate for wire and cable markers (MG-TPM)
- 1 MG2-PLT support plate for wire and cable markers (MG-TPMF) and various labels and signs
- 1 MG2-ETB Support plate for SNK series terminal block markers (MG-CPM-13)
- 1 MG2-ETR Black printing ribbon.



### Genius Pro software

The Genius Pro software application benefits from long experience in the field and requires the operator to have only basic skills in order to use it. It is application-oriented and provides fast and easy data entry including a dynamic full-size media preview giving an accurate representation of the current job.

Features / characteristics:

- More than ten types of counter such as \*.txt, \*.cad, \*.dbf, \*.xls can be imported
- AutoCAD, Elcad, Spac and Excel import
- MATRIX, ACS and Simplo conversion
- Optimised printing of media for cables, terminal blocks, control gear, connectors, push buttons, components, panels and self-adhesive labels
- Specially developed proprietary Genius font and also Windows fonts
- Designs customised media
- Vector, drawing and clip art printing
- Free upgrades for each new release
- Microsoft® Windows® XP, Windows Vista®, Windows 2000 SP4®, Windows 7®.

## AMS 600 and AMS 250 plotter

The universal standard for printing jobs



### AMS 600

#### Universal printing plotter

Compatible with all original manufacturer terminal block markers (polyamide), it can also print other identification supports such as: wire and cable markers, push buttons, panels... This plotter offers a large working area, hosting up to 4 different support plates for one plot job.

#### Error detection mode

The A3 panel automatically recognises the support plate and avoids the need to select marking elements, it also warns the user when the support is wrongly installed.

#### Dry out protection system

Pens are prevented from drying out thanks to AMS 600 integrated pen station.



### AMS 250

#### Compact

This A4 plotter is smaller than AMS 600 and is more suited to a cluttered environment.

## Automatic installation

The installation program starts automatically. The computer just needs to be rebooted after it has finished and printing can start.

## What you see is what you get !

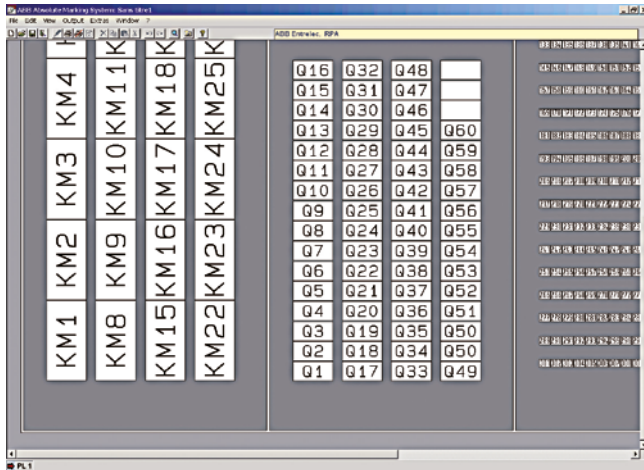

User friendly  
Microsoft® Windows® software

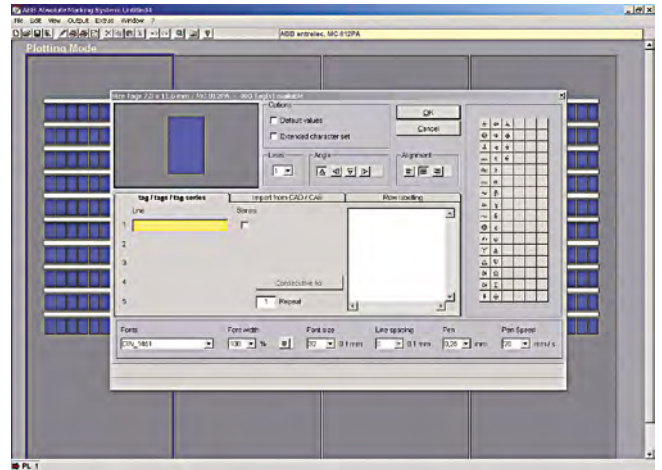

Time saving: data import function  
from CAD, TXT and Excel® files



### New special ink disposable plotter pens ED-R

- Disposable pens ED-R almost never clog, they are ideal for use in particularly dry environments.
- These pens are filled with the permanent ink ED, most suitable for marking various plastic surfaces.
- The ED ink should only be used on plastic material. Do not clean or touch with aggressive fluids.
- For applications outside of the control panel the ink P 2.0 is more suitable and durable.



## Terminal block markers

Blank card in polycarbonate - 5.2 mm 0.205 in spacing



MC512

### MC512 terminal block markers

#### Description

- MC512 marker card in polycarbonate for high marking quality, durability and speed when marked with the HTP500 printer,
- Excellent marking durability in the most severe environments,
- Improved marking visibility thanks to the increased marking surface +20% (12 mm 0.472 in).

#### Main technical data

Material	Flammability	Maximum printed digits				Dimensions	
		mm		inches			
Polycarbonate	V0	Horizontal	3	Vertical	8	4.8 x 12	0.189 x 0.472

#### Ordering details

Description	Number of markers per card	Color	Type	Part Number	Pkg card	Weight (1 pce) g
Blank card	45	White <input type="checkbox"/>	MC512	1SNK140000R0000	22	9.00
		Yellow <input checked="" type="checkbox"/>	MC512-YL	1SNK140004R0000	22	9.00



HTP500-V2

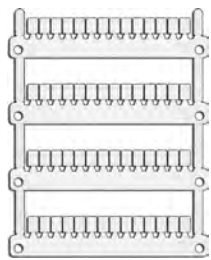

MG-CPM-13

### MG-CPM-13 terminal block markers

#### Description

- MG-CPM-13 41790 and 41740 markers are used for marking 5.2 mm 0.205 in spacing SNK terminal blocks,
- Provide an elevate mechanical robustness, high dimensional stability and are halogen free,
- Single application on terminal block,
- 35 cards per packing

#### Main technical data

Material	Flammability	Maximum printed digits				Dimensions	
		mm		inches			
Polycarbonate	V2	Horizontal	3	Vertical	8	4.8 x 12	0.196 x 0.472

#### Ordering details

Description	Number of markers per card	Color	Type	Part Number	Pkg marker	Weight (1 pce) g
Blank card	56	White <input type="checkbox"/>	MG-CPM 13 41790	1SNB041790R0512	1960	0.232
		Yellow <input checked="" type="checkbox"/>	MG-CPM 13 41740	1SNB041740R0512	1960	0.232

#### Marking systems

Description	Type	Part Number	Pkg qty	Weight (1 pce) g
Thermal transfer printer	MG3 KIT	1SNB419001R0000	1	12600.00

#### Marking systems accessories

Description	Type	Part Number	Pkg qty	Weight (1 pce) g
Support plate for MG-CPM-13	MG2-ETB 991016	1SNB991016R0000	1	100.00



MG3 KIT

## Terminal block markers

Blank card in polyamide - 5.2 mm 0.205 in spacing



MC512PA



AMS 600

### MC512PA terminal block markers

#### Description

- MC512PA marker card in polyamide to be marked on AMS 600 marking table for medium scale volumes and standard industrial applications,
- Terminal blocks are directly independent after strip mounting,
- Improved marking visibility thanks to the increased marking surface +20% (12 mm 0.472 in).

#### Main technical data

Material	Flammability	Maximum printed digits				Dimensions	
		Horizontal	Vertical	Horizontal	Vertical	mm	inches
Polyamide	V2	3	8	4.8 x 12	0.189 x 0.472		

#### Ordering details

Description	Number of markers per card	Color	Type	Part Number	Pkg card	Weight (1 pce) g
Blank card	100	White <input type="checkbox"/>	MC512PA	1SNK149999R0000	20	10.00

#### Marking systems

Description	Type	Part Number	Pkg qty	Weight (1 pce) g
AMS plotter	AMS 600 KIT	1SNA360000R2400	1	12600.00

#### Marking systems accessories

Description	Type	Part Number	Pkg qty	Weight (1 pce) g
Marking support plate for MC PA marker cards (3 MC PA marker cards per plate)	SPRC 30-3	1SNA360039R1700	1	300.00

# MC512PA terminal block markers

## Pre-printed marker card for horizontal terminal block assembly



MC512PA



5.2 mm 0.205 in spacing

### Description

Save printing time with our large pre-printed cards offer with pre-printed numbers, letters or symbols.

### Main technical data

Material	Flammability	Dimensions	
		mm	inches
Polyamide	V2	4.8 x 12	0.189 x 0.472

### Ordering details

Description	Number of markers per card	Color	Type	Part Number	Pkg card	Weight (1 pce) g
0->9 (x10)	100	White <input type="checkbox"/>	MC512PA	1SNK140091R0000	1	10.00
1->10 (x10)	100	White <input type="checkbox"/>	MC512PA	1SNK140011R0000	1	10.00
11->20 (x10)	100	White <input type="checkbox"/>	MC512PA	1SNK140021R0000	1	10.00
21->30 (x10)	100	White <input type="checkbox"/>	MC512PA	1SNK140031R0000	1	10.00
31->40 (x10)	100	White <input type="checkbox"/>	MC512PA	1SNK140041R0000	1	10.00
41->50 (x10)	100	White <input type="checkbox"/>	MC512PA	1SNK140051R0000	1	10.00
51->60 (x10)	100	White <input type="checkbox"/>	MC512PA	1SNK140061R0000	1	10.00
61->70 (x10)	100	White <input type="checkbox"/>	MC512PA	1SNK140071R0000	1	10.00
71->80 (x10)	100	White <input type="checkbox"/>	MC512PA	1SNK140081R0000	1	10.00
81->90 (x10)	100	White <input type="checkbox"/>	MC512PA	1SNK140083R0000	1	10.00
91->100 (x10)	100	White <input type="checkbox"/>	MC512PA	1SNK140101R0000	1	10.00
101->110 (x10)	100	White <input type="checkbox"/>	MC512PA	1SNK140111R0000	1	10.00
111->120 (x10)	100	White <input type="checkbox"/>	MC512PA	1SNK140121R0000	1	10.00
121->130 (x10)	100	White <input type="checkbox"/>	MC512PA	1SNK140131R0000	1	10.00
131->140 (x10)	100	White <input type="checkbox"/>	MC512PA	1SNK140141R0000	1	10.00
141->150 (x10)	100	White <input type="checkbox"/>	MC512PA	1SNK140151R0000	1	10.00
151->160 (x10)	100	White <input type="checkbox"/>	MC512PA	1SNK140161R0000	1	10.00
161->170 (x10)	100	White <input type="checkbox"/>	MC512PA	1SNK140171R0000	1	10.00
171->180 (x10)	100	White <input type="checkbox"/>	MC512PA	1SNK140181R0000	1	10.00
181->190 (x10)	100	White <input type="checkbox"/>	MC512PA	1SNK140191R0000	1	10.00
191->200 (x10)	100	White <input type="checkbox"/>	MC512PA	1SNK140201R0000	1	10.00
1->100	100	White <input type="checkbox"/>	MC512PA	1SNK145011R0000	1	10.00
101->200	100	White <input type="checkbox"/>	MC512PA	1SNK145021R0000	1	10.00
201->300	100	White <input type="checkbox"/>	MC512PA	1SNK145031R0000	1	10.00
301->400	100	White <input type="checkbox"/>	MC512PA	1SNK145041R0000	1	10.00
401->500	100	White <input type="checkbox"/>	MC512PA	1SNK145051R0000	1	10.00
501->600	100	White <input type="checkbox"/>	MC512PA	1SNK145061R0000	1	10.00
601->700	100	White <input type="checkbox"/>	MC512PA	1SNK145071R0000	1	10.00
701->800	100	White <input type="checkbox"/>	MC512PA	1SNK145081R0000	1	10.00
801->900	100	White <input type="checkbox"/>	MC512PA	1SNK145091R0000	1	10.00
A (x100)	100	White <input type="checkbox"/>	MC512PA	1SNK146011R0000	1	10.00
B (x100)	100	White <input type="checkbox"/>	MC512PA	1SNK146021R0000	1	10.00
C (x100)	100	White <input type="checkbox"/>	MC512PA	1SNK146031R0000	1	10.00
D (x100)	100	White <input type="checkbox"/>	MC512PA	1SNK146041R0000	1	10.00
E (x100)	100	White <input type="checkbox"/>	MC512PA	1SNK146051R0000	1	10.00
F (x100)	100	White <input type="checkbox"/>	MC512PA	1SNK146061R0000	1	10.00
G (x100)	100	White <input type="checkbox"/>	MC512PA	1SNK146071R0000	1	10.00
H (x100)	100	White <input type="checkbox"/>	MC512PA	1SNK146081R0000	1	10.00
I (x100)	100	White <input type="checkbox"/>	MC512PA	1SNK146091R0000	1	10.00
J (x100)	100	White <input type="checkbox"/>	MC512PA	1SNK146101R0000	1	10.00
K (x100)	100	White <input type="checkbox"/>	MC512PA	1SNK146111R0000	1	10.00
L (x100)	100	White <input type="checkbox"/>	MC512PA	1SNK146121R0000	1	10.00
M (x100)	100	White <input type="checkbox"/>	MC512PA	1SNK146131R0000	1	10.00
N (x100)	100	White <input type="checkbox"/>	MC512PA	1SNK146141R0000	1	10.00
O (x100)	100	White <input type="checkbox"/>	MC512PA	1SNK146151R0000	1	10.00
P (x100)	100	White <input type="checkbox"/>	MC512PA	1SNK146161R0000	1	10.00
Q (x100)	100	White <input type="checkbox"/>	MC512PA	1SNK146171R0000	1	10.00
R (x100)	100	White <input type="checkbox"/>	MC512PA	1SNK146181R0000	1	10.00
S (x100)	100	White <input type="checkbox"/>	MC512PA	1SNK146191R0000	1	10.00
T (x100)	100	White <input type="checkbox"/>	MC512PA	1SNK146201R0000	1	10.00
U (x100)	100	White <input type="checkbox"/>	MC512PA	1SNK146211R0000	1	10.00
V (x100)	100	White <input type="checkbox"/>	MC512PA	1SNK146221R0000	1	10.00
W (x100)	100	White <input type="checkbox"/>	MC512PA	1SNK146231R0000	1	10.00
X (x100)	100	White <input type="checkbox"/>	MC512PA	1SNK146241R0000	1	10.00
Y (x100)	100	White <input type="checkbox"/>	MC512PA	1SNK146251R0000	1	10.00

Continue on next page →

1SNK160004S0201 - Rev. A

## MC512PA terminal block markers

### Pre-printed marker card for horizontal terminal block assembly



MC512PA



5.2 mm 0.205 in spacing

#### Ordering details

Description	Number of markers per card	Color	Type	Part Number	Pkg card	Weight (1 pce) g
← Continuation of previous page						
Z (x100)	100	White	MC512PA	1SNK146261R0000	1	10.00
0 (x100)	100	White	MC512PA	1SNK147001R0000	1	10.00
1 (x100)	100	White	MC512PA	1SNK147011R0000	1	10.00
2 (x100)	100	White	MC512PA	1SNK147021R0000	1	10.00
3 (x100)	100	White	MC512PA	1SNK147031R0000	1	10.00
4 (x100)	100	White	MC512PA	1SNK147041R0000	1	10.00
5 (x100)	100	White	MC512PA	1SNK147051R0000	1	10.00
6 (x100)	100	White	MC512PA	1SNK147061R0000	1	10.00
7 (x100)	100	White	MC512PA	1SNK147071R0000	1	10.00
8 (x100)	100	White	MC512PA	1SNK147081R0000	1	10.00
9 (x100)	100	White	MC512PA	1SNK147091R0000	1	10.00
+ (x100)	100	White	MC512PA	1SNK148001R0000	1	10.00
- (x100)	100	White	MC512PA	1SNK148011R0000	1	10.00
~ (x100)	100	White	MC512PA	1SNK148021R0000	1	10.00
= (x100)	100	White	MC512PA	1SNK148031R0000	1	10.00
≠ (x100)	100	White	MC512PA	1SNK148041R0000	1	10.00
L1 (x100)	100	White	MC512PA	1SNK148051R0000	1	10.00
L2 (x100)	100	White	MC512PA	1SNK148061R0000	1	10.00
L3 (x100)	100	White	MC512PA	1SNK148071R0000	1	10.00
PE (x100)	100	White	MC512PA	1SNK148091R0000	1	10.00
U1 (x100)	100	White	MC512PA	1SNK148101R0000	1	10.00
U2 (x100)	100	White	MC512PA	1SNK148111R0000	1	10.00
U3 (x100)	100	White	MC512PA	1SNK148121R0000	1	10.00
V1 (x100)	100	White	MC512PA	1SNK148131R0000	1	10.00
V2 (x100)	100	White	MC512PA	1SNK148141R0000	1	10.00
V3 (x100)	100	White	MC512PA	1SNK148151R0000	1	10.00
W1 (x100)	100	White	MC512PA	1SNK148161R0000	1	10.00
W2 (x100)	100	White	MC512PA	1SNK148171R0000	1	10.00
W3 (x100)	100	White	MC512PA	1SNK148181R0000	1	10.00
L1-L2-L3-N-PE (x20)	100	White	MC512PA	1SNK149001R0000	1	10.00
U1-U2-U3-V1-V2-V3-W1-W2-W3 (x10) + U1 (x10)	100	White	MC512PA	1SNK149011R0000	1	10.00

# MC512PA terminal block markers

## Pre-printed marker card for vertical terminal block assembly



MC512PA



5.2 mm 0.205 in spacing

### Description

Save printing time with our large pre-printed cards offer with pre-printed numbers, letters or symbols.

### Main technical data

Material	Flammability	Dimensions	
		mm	inches
Polyamide	V2	4.8 x 12	0.189 x 0.472

### Ordering details

Description	Number of markers per card	Color	Type	Part Number	Pkg card	Weight (1 pce) g
0->9 (x10)	100	White <input type="checkbox"/>	MC512PA	1SNK140092R0000	1	10.00
1->10 (x10)	100	White <input type="checkbox"/>	MC512PA	1SNK140012R0000	1	10.00
11->20 (x10)	100	White <input type="checkbox"/>	MC512PA	1SNK140022R0000	1	10.00
21->30 (x10)	100	White <input type="checkbox"/>	MC512PA	1SNK140032R0000	1	10.00
31->40 (x10)	100	White <input type="checkbox"/>	MC512PA	1SNK140042R0000	1	10.00
41->50 (x10)	100	White <input type="checkbox"/>	MC512PA	1SNK140052R0000	1	10.00
51->60 (x10)	100	White <input type="checkbox"/>	MC512PA	1SNK140062R0000	1	10.00
61->70 (x10)	100	White <input type="checkbox"/>	MC512PA	1SNK140072R0000	1	10.00
71->80 (x10)	100	White <input type="checkbox"/>	MC512PA	1SNK140082R0000	1	10.00
81->90 (x10)	100	White <input type="checkbox"/>	MC512PA	1SNK140084R0000	1	10.00
91->100 (x10)	100	White <input type="checkbox"/>	MC512PA	1SNK140102R0000	1	10.00
101->110 (x10)	100	White <input type="checkbox"/>	MC512PA	1SNK140112R0000	1	10.00
111->120 (x10)	100	White <input type="checkbox"/>	MC512PA	1SNK140122R0000	1	10.00
121->130 (x10)	100	White <input type="checkbox"/>	MC512PA	1SNK140132R0000	1	10.00
131->140 (x10)	100	White <input type="checkbox"/>	MC512PA	1SNK140142R0000	1	10.00
141->150 (x10)	100	White <input type="checkbox"/>	MC512PA	1SNK140152R0000	1	10.00
151->160 (x10)	100	White <input type="checkbox"/>	MC512PA	1SNK140162R0000	1	10.00
161->170 (x10)	100	White <input type="checkbox"/>	MC512PA	1SNK140172R0000	1	10.00
171->180 (x10)	100	White <input type="checkbox"/>	MC512PA	1SNK140182R0000	1	10.00
181->190 (x10)	100	White <input type="checkbox"/>	MC512PA	1SNK140192R0000	1	10.00
191->200 (x10)	100	White <input type="checkbox"/>	MC512PA	1SNK140202R0000	1	10.00
1->100	100	White <input type="checkbox"/>	MC512PA	1SNK145012R0000	1	10.00
101->200	100	White <input type="checkbox"/>	MC512PA	1SNK145022R0000	1	10.00
201->300	100	White <input type="checkbox"/>	MC512PA	1SNK145032R0000	1	10.00
301->400	100	White <input type="checkbox"/>	MC512PA	1SNK145042R0000	1	10.00
401->500	100	White <input type="checkbox"/>	MC512PA	1SNK145052R0000	1	10.00
501->600	100	White <input type="checkbox"/>	MC512PA	1SNK145062R0000	1	10.00
601->700	100	White <input type="checkbox"/>	MC512PA	1SNK145072R0000	1	10.00
701->800	100	White <input type="checkbox"/>	MC512PA	1SNK145082R0000	1	10.00
801->900	100	White <input type="checkbox"/>	MC512PA	1SNK145092R0000	1	10.00
901->1000	100	White <input type="checkbox"/>	MC512PA	1SNK145102R0000	1	10.00
A (x100)	100	White <input type="checkbox"/>	MC512PA	1SNK146012R0000	1	10.00
B (x100)	100	White <input type="checkbox"/>	MC512PA	1SNK146022R0000	1	10.00
C (x100)	100	White <input type="checkbox"/>	MC512PA	1SNK146032R0000	1	10.00
D (x100)	100	White <input type="checkbox"/>	MC512PA	1SNK146042R0000	1	10.00
E (x100)	100	White <input type="checkbox"/>	MC512PA	1SNK146052R0000	1	10.00
F (x100)	100	White <input type="checkbox"/>	MC512PA	1SNK146062R0000	1	10.00
G (x100)	100	White <input type="checkbox"/>	MC512PA	1SNK146072R0000	1	10.00
H (x100)	100	White <input type="checkbox"/>	MC512PA	1SNK146082R0000	1	10.00
I (x100)	100	White <input type="checkbox"/>	MC512PA	1SNK146092R0000	1	10.00
J (x100)	100	White <input type="checkbox"/>	MC512PA	1SNK146102R0000	1	10.00
K (x100)	100	White <input type="checkbox"/>	MC512PA	1SNK146112R0000	1	10.00
L (x100)	100	White <input type="checkbox"/>	MC512PA	1SNK146122R0000	1	10.00
M (x100)	100	White <input type="checkbox"/>	MC512PA	1SNK146132R0000	1	10.00
N (x100)	100	White <input type="checkbox"/>	MC512PA	1SNK146142R0000	1	10.00
O (x100)	100	White <input type="checkbox"/>	MC512PA	1SNK146152R0000	1	10.00
P (x100)	100	White <input type="checkbox"/>	MC512PA	1SNK146162R0000	1	10.00
Q (x100)	100	White <input type="checkbox"/>	MC512PA	1SNK146172R0000	1	10.00
R (x100)	100	White <input type="checkbox"/>	MC512PA	1SNK146182R0000	1	10.00
S (x100)	100	White <input type="checkbox"/>	MC512PA	1SNK146192R0000	1	10.00
T (x100)	100	White <input type="checkbox"/>	MC512PA	1SNK146202R0000	1	10.00
U (x100)	100	White <input type="checkbox"/>	MC512PA	1SNK146212R0000	1	10.00
V (x100)	100	White <input type="checkbox"/>	MC512PA	1SNK146222R0000	1	10.00

Continue on next page →

1SNK16005S0201 - Rev. A



# MC512PA terminal block markers

## Pre-printed marker card for vertical terminal block assembly



MC512PA



5.2 mm 0.205 in spacing

### Ordering details

Description	Number of markers per card	Color	Type	Part Number	Pkg card	Weight (1 pce) g
← Continuation of previous page						
W (x100)	100	White <input type="checkbox"/>	MC512PA	1SNK146232R0000	1	10.00
X (x100)	100	White <input type="checkbox"/>	MC512PA	1SNK146242R0000	1	10.00
Y (x100)	100	White <input type="checkbox"/>	MC512PA	1SNK146252R0000	1	10.00
Z (x100)	100	White <input type="checkbox"/>	MC512PA	1SNK146262R0000	1	10.00
0 (x100)	100	White <input type="checkbox"/>	MC512PA	1SNK147002R0000	1	10.00
1 (x100)	100	White <input type="checkbox"/>	MC512PA	1SNK147012R0000	1	10.00
2 (x100)	100	White <input type="checkbox"/>	MC512PA	1SNK147022R0000	1	10.00
3 (x100)	100	White <input type="checkbox"/>	MC512PA	1SNK147032R0000	1	10.00
4 (x100)	100	White <input type="checkbox"/>	MC512PA	1SNK147042R0000	1	10.00
5 (x100)	100	White <input type="checkbox"/>	MC512PA	1SNK147052R0000	1	10.00
6 (x100)	100	White <input type="checkbox"/>	MC512PA	1SNK147062R0000	1	10.00
7 (x100)	100	White <input type="checkbox"/>	MC512PA	1SNK147072R0000	1	10.00
8 (x100)	100	White <input type="checkbox"/>	MC512PA	1SNK147082R0000	1	10.00
9 (x100)	100	White <input type="checkbox"/>	MC512PA	1SNK147092R0000	1	10.00
+ (x100)	100	White <input type="checkbox"/>	MC512PA	1SNK148002R0000	1	10.00
- (x100)	100	White <input type="checkbox"/>	MC512PA	1SNK148012R0000	1	10.00
~ (x100)	100	White <input type="checkbox"/>	MC512PA	1SNK148022R0000	1	10.00
= (x100)	100	White <input type="checkbox"/>	MC512PA	1SNK148032R0000	1	10.00
± (x100)	100	White <input type="checkbox"/>	MC512PA	1SNK148042R0000	1	10.00
L1 (x100)	100	White <input type="checkbox"/>	MC512PA	1SNK148052R0000	1	10.00
L2 (x100)	100	White <input type="checkbox"/>	MC512PA	1SNK148062R0000	1	10.00
L3 (x100)	100	White <input type="checkbox"/>	MC512PA	1SNK148072R0000	1	10.00
PE (x100)	100	White <input type="checkbox"/>	MC512PA	1SNK148092R0000	1	10.00
U1 (x100)	100	White <input type="checkbox"/>	MC512PA	1SNK148102R0000	1	10.00
U2 (x100)	100	White <input type="checkbox"/>	MC512PA	1SNK148112R0000	1	10.00
U3 (x100)	100	White <input type="checkbox"/>	MC512PA	1SNK148122R0000	1	10.00
V1 (x100)	100	White <input type="checkbox"/>	MC512PA	1SNK148132R0000	1	10.00
V2 (x100)	100	White <input type="checkbox"/>	MC512PA	1SNK148142R0000	1	10.00
V3 (x100)	100	White <input type="checkbox"/>	MC512PA	1SNK148152R0000	1	10.00
W1 (x100)	100	White <input type="checkbox"/>	MC512PA	1SNK148162R0000	1	10.00
W2 (x100)	100	White <input type="checkbox"/>	MC512PA	1SNK148172R0000	1	10.00
W3 (x100)	100	White <input type="checkbox"/>	MC512PA	1SNK148182R0000	1	10.00
+24V (x100)	100	White <input type="checkbox"/>	MC512PA	1SNK148192R0000	1	10.00
+48V (x100)	100	White <input type="checkbox"/>	MC512PA	1SNK148202R0000	1	10.00
-24V (x100)	100	White <input type="checkbox"/>	MC512PA	1SNK148212R0000	1	10.00
-48V (x100)	100	White <input type="checkbox"/>	MC512PA	1SNK148222R0000	1	10.00
L1-L2-L3-N-PE (x20)	100	White <input type="checkbox"/>	MC512PA	1SNK149002R0000	1	10.00
U1-U2-U3-V1-V2-V3-W1-W2-W3 (x10) + U1 (x10)	100	White <input type="checkbox"/>	MC512PA	1SNK149012R0000	1	10.00

## Terminal block markers

Blank card in polycarbonate - 6 mm 0.236 in spacing



MC612



HTP500-V2

### MC612 terminal block markers

#### Description

- MC612 marker card in polycarbonate for high marking quality, durability and speed when marked with the HTP500 printer,
- Excellent marking durability in the most severe environments,
- Improved marking visibility thanks to the increased marking surface +20% (12 mm 0.472 in).

#### Main technical data

Material	Flammability	Maximum printed digits				Dimensions	
		mm		inches			
Polycarbonate	V0	Horizontal	3	Vertical	8	5.6 x 12	0.220 x 0.472

#### Ordering details

Description	Number of markers per card	Color	Type	Part number	Pkg	Weight
						card
Blank card	39	White <input type="checkbox"/>	MC612	1SNK150000R0000	22	10.00
		Yellow <input checked="" type="checkbox"/>	MC612-YL	1SNK150004R0000	22	10.00

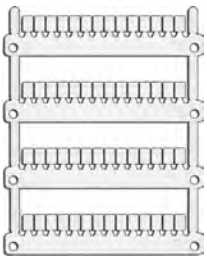

MG-CPM-13



MG3 KIT

### MG-CPM-13 terminal block markers

#### Description

- MG-CPM-13 41791 and 41741 markers are used for marking 6 mm 0.236 in spacing SNK terminal blocks,
- Provide an elevate mechanical robustness, high dimensional stability and are halogen free,
- Single application on terminal block,
- 35 cards per packing.

#### Main technical data

Material	Flammability	Maximum printed digits				Dimensions	
		mm		inches			
Polycarbonate	V0	Horizontal	3	Vertical	8	5.6 x 12	0.236 x 0.472

#### Ordering details

Description	Number of markers per card	Color	Type	Part number	Pkg	Weight
						marker
Blank card	48	White <input type="checkbox"/>	MG-CPM 13 41791	1SNB041791R0612	1680	0.273
		Yellow <input checked="" type="checkbox"/>	MG-CPM 13 41741	1SNB041741R0612	1680	0.273

#### Marking systems

Description	Type	Part number	Pkg	Weight
			qty	(1 pce) g
Thermal transfer printer	MG3 KIT	1SNB419001R0000	1	12600.00

#### Marking systems accessories

Description	Type	Part number	Pkg	Weight
			qty	(1 pce) g
Support plate for MG-CPM-13	MG2-ETB 991016	1SNB991016R0000	1	100.00

## Terminal block markers

Blank card in polyamide - 6 mm 0.236 in spacing



MC612



AMS 600

### MC612PA terminal block markers

#### Description

- MC612PA marker card in polyamide to be marked on AMS 600 marking table for medium scale volumes and standard industrial applications,
- Terminal blocks are directly independent after strip mounting,
- Improved marking visibility thanks to the increased marking surface +20% (12 mm 0.472 in).

#### Main technical data

Material	Flammability	Maximum printed digits		Dimensions	
		Horizontal	Vertical	mm	inches
Polyamide	V2	3	8	5.6 x 12	0.220 x 0.472

#### Ordering details

Description	Number of markers per card	Color	Type	Part Number	Pkg card	Weight (1 pce) g
Blank card	100	White <input type="checkbox"/>	MC612PA	1SNK159999R0000	20	11.00

#### Marking systems

Description	Type	Part Number	Pkg qty	Weight (1 pce) g
AMS plotter	AMS 600 KIT	1SNA360000R2400	1	12600.00

#### Marking systems accessories

Description	Type	Part Number	Pkg qty	Weight (1 pce) g
Marking support plate for MC PA marker cards (3 MC PA marker cards per plate)	SPRC 30-3	1SNA360039R1700	1	300.00

# MC612PA terminal block markers

## Pre-printed marker card for horizontal terminal block assembly



MC612PA



6 mm 0.236 in spacing

### Description

Save printing time with our large pre-printed cards offer with pre-printed numbers, letters or symbols.

### Main technical data

Material	Flammability	Dimensions	
		mm	inches
Polyamide	V2	5.6 x 12	0.220 x 0.472

### Ordering details

Description	Number of markers per card	Color	Type	Part Number	Pkg card	Weight (1 pce) g
0->9 (x10)	100	White <input type="checkbox"/>	MC612PA	1SNK150091R0000	1	11.00
1->10 (x10)	100	White <input type="checkbox"/>	MC612PA	1SNK150011R0000	1	11.00
11->20 (x10)	100	White <input type="checkbox"/>	MC612PA	1SNK150021R0000	1	11.00
21->30 (x10)	100	White <input type="checkbox"/>	MC612PA	1SNK150031R0000	1	11.00
31->40 (x10)	100	White <input type="checkbox"/>	MC612PA	1SNK150041R0000	1	11.00
41->50 (x10)	100	White <input type="checkbox"/>	MC612PA	1SNK150051R0000	1	11.00
51->60 (x10)	100	White <input type="checkbox"/>	MC612PA	1SNK150061R0000	1	11.00
61->70 (x10)	100	White <input type="checkbox"/>	MC612PA	1SNK150071R0000	1	11.00
71->80 (x10)	100	White <input type="checkbox"/>	MC612PA	1SNK150081R0000	1	11.00
81->90 (x10)	100	White <input type="checkbox"/>	MC612PA	1SNK150083R0000	1	11.00
91->100 (x10)	100	White <input type="checkbox"/>	MC612PA	1SNK150101R0000	1	11.00
101->110 (x10)	100	White <input type="checkbox"/>	MC612PA	1SNK150111R0000	1	11.00
111->120 (x10)	100	White <input type="checkbox"/>	MC612PA	1SNK150121R0000	1	11.00
121->130 (x10)	100	White <input type="checkbox"/>	MC612PA	1SNK150131R0000	1	11.00
131->140 (x10)	100	White <input type="checkbox"/>	MC612PA	1SNK150141R0000	1	11.00
141->150 (x10)	100	White <input type="checkbox"/>	MC612PA	1SNK150151R0000	1	11.00
151->160 (x10)	100	White <input type="checkbox"/>	MC612PA	1SNK150161R0000	1	11.00
161->170 (x10)	100	White <input type="checkbox"/>	MC612PA	1SNK150171R0000	1	11.00
171->180 (x10)	100	White <input type="checkbox"/>	MC612PA	1SNK150181R0000	1	11.00
181->190 (x10)	100	White <input type="checkbox"/>	MC612PA	1SNK150191R0000	1	11.00
191->200 (x10)	100	White <input type="checkbox"/>	MC612PA	1SNK150201R0000	1	11.00
1->100	100	White <input type="checkbox"/>	MC612PA	1SNK155011R0000	1	11.00
101->200	100	White <input type="checkbox"/>	MC612PA	1SNK155021R0000	1	11.00
201->300	100	White <input type="checkbox"/>	MC612PA	1SNK155031R0000	1	11.00
301->400	100	White <input type="checkbox"/>	MC612PA	1SNK155041R0000	1	11.00
401->500	100	White <input type="checkbox"/>	MC612PA	1SNK155051R0000	1	11.00
501->600	100	White <input type="checkbox"/>	MC612PA	1SNK155061R0000	1	11.00
601->700	100	White <input type="checkbox"/>	MC612PA	1SNK155071R0000	1	11.00
701->800	100	White <input type="checkbox"/>	MC612PA	1SNK155081R0000	1	11.00
801->900	100	White <input type="checkbox"/>	MC612PA	1SNK155091R0000	1	11.00
A (x100)	100	White <input type="checkbox"/>	MC612PA	1SNK156011R0000	1	11.00
B (x100)	100	White <input type="checkbox"/>	MC612PA	1SNK156021R0000	1	11.00
C (x100)	100	White <input type="checkbox"/>	MC612PA	1SNK156031R0000	1	11.00
D (x100)	100	White <input type="checkbox"/>	MC612PA	1SNK156041R0000	1	11.00
E (x100)	100	White <input type="checkbox"/>	MC612PA	1SNK156051R0000	1	11.00
F (x100)	100	White <input type="checkbox"/>	MC612PA	1SNK156061R0000	1	11.00
G (x100)	100	White <input type="checkbox"/>	MC612PA	1SNK156071R0000	1	11.00
H (x100)	100	White <input type="checkbox"/>	MC612PA	1SNK156081R0000	1	11.00
I (x100)	100	White <input type="checkbox"/>	MC612PA	1SNK156091R0000	1	11.00
J (x100)	100	White <input type="checkbox"/>	MC612PA	1SNK156101R0000	1	11.00
K (x100)	100	White <input type="checkbox"/>	MC612PA	1SNK156111R0000	1	11.00
L (x100)	100	White <input type="checkbox"/>	MC612PA	1SNK156121R0000	1	11.00
M (x100)	100	White <input type="checkbox"/>	MC612PA	1SNK156131R0000	1	11.00
N (x100)	100	White <input type="checkbox"/>	MC612PA	1SNK156141R0000	1	11.00
O (x100)	100	White <input type="checkbox"/>	MC612PA	1SNK156151R0000	1	11.00
P (x100)	100	White <input type="checkbox"/>	MC612PA	1SNK156161R0000	1	11.00
Q (x100)	100	White <input type="checkbox"/>	MC612PA	1SNK156171R0000	1	11.00
R (x100)	100	White <input type="checkbox"/>	MC612PA	1SNK156181R0000	1	11.00
S (x100)	100	White <input type="checkbox"/>	MC612PA	1SNK156191R0000	1	11.00
T (x100)	100	White <input type="checkbox"/>	MC612PA	1SNK156201R0000	1	11.00
U (x100)	100	White <input type="checkbox"/>	MC612PA	1SNK156211R0000	1	11.00
V (x100)	100	White <input type="checkbox"/>	MC612PA	1SNK156221R0000	1	11.00
W (x100)	100	White <input type="checkbox"/>	MC612PA	1SNK156231R0000	1	11.00

Continue on next page →

1SNK160007S0201 - Rev. A

## MC612PA terminal block markers

Pre-printed marker card for horizontal terminal block assembly



MC612PA



6 mm 0.236 in spacing

### Ordering details

Description	Number of markers per card	Color	Type	Part Number	Pkg card	Weight (1 pce)
← Continuation of previous page						
X (x100)	100	White <input type="checkbox"/>	MC612PA	1SNK156241R0000	1	11.00
Y (x100)	100	White <input type="checkbox"/>	MC612PA	1SNK156251R0000	1	11.00
Z (x100)	100	White <input type="checkbox"/>	MC612PA	1SNK156261R0000	1	11.00
0 (x100)	100	White <input type="checkbox"/>	MC612PA	1SNK157001R0000	1	11.00
1 (x100)	100	White <input type="checkbox"/>	MC612PA	1SNK157011R0000	1	11.00
2 (x100)	100	White <input type="checkbox"/>	MC612PA	1SNK157021R0000	1	11.00
3 (x100)	100	White <input type="checkbox"/>	MC612PA	1SNK157031R0000	1	11.00
4 (x100)	100	White <input type="checkbox"/>	MC612PA	1SNK157041R0000	1	11.00
5 (x100)	100	White <input type="checkbox"/>	MC612PA	1SNK157051R0000	1	11.00
6 (x100)	100	White <input type="checkbox"/>	MC612PA	1SNK157061R0000	1	11.00
7 (x100)	100	White <input type="checkbox"/>	MC612PA	1SNK157071R0000	1	11.00
8 (x100)	100	White <input type="checkbox"/>	MC612PA	1SNK157081R0000	1	11.00
9 (x100)	100	White <input type="checkbox"/>	MC612PA	1SNK157091R0000	1	11.00
+ (x100)	100	White <input type="checkbox"/>	MC612PA	1SNK158001R0000	1	11.00
- (x100)	100	White <input type="checkbox"/>	MC612PA	1SNK158011R0000	1	11.00
~ (x100)	100	White <input type="checkbox"/>	MC612PA	1SNK158021R0000	1	11.00
= (x100)	100	White <input type="checkbox"/>	MC612PA	1SNK158031R0000	1	11.00
Ground (x100)	100	White <input type="checkbox"/>	MC612PA	1SNK158041R0000	1	11.00
L1 (x100)	100	White <input type="checkbox"/>	MC612PA	1SNK158051R0000	1	11.00
L2 (x100)	100	White <input type="checkbox"/>	MC612PA	1SNK158061R0000	1	11.00
L3 (x100)	100	White <input type="checkbox"/>	MC612PA	1SNK158071R0000	1	11.00
PE (x100)	100	White <input type="checkbox"/>	MC612PA	1SNK158091R0000	1	11.00
U1 (x100)	100	White <input type="checkbox"/>	MC612PA	1SNK158101R0000	1	11.00
U2 (x100)	100	White <input type="checkbox"/>	MC612PA	1SNK158111R0000	1	11.00
U3 (x100)	100	White <input type="checkbox"/>	MC612PA	1SNK158121R0000	1	11.00
V1 (x100)	100	White <input type="checkbox"/>	MC612PA	1SNK158131R0000	1	11.00
V2 (x100)	100	White <input type="checkbox"/>	MC612PA	1SNK158141R0000	1	11.00
V3 (x100)	100	White <input type="checkbox"/>	MC612PA	1SNK158151R0000	1	11.00
W1 (x100)	100	White <input type="checkbox"/>	MC612PA	1SNK158161R0000	1	11.00
W2 (x100)	100	White <input type="checkbox"/>	MC612PA	1SNK158171R0000	1	11.00
W3 (x100)	100	White <input type="checkbox"/>	MC612PA	1SNK158181R0000	1	11.00
L1-L2-L3-N-PE (x20)	100	White <input type="checkbox"/>	MC612PA	1SNK159001R0000	1	11.00
U1-U2-U3-V1-V2-V3-W1-W2-W3 (x10) + U1 (x10)	100	White <input type="checkbox"/>	MC612PA	1SNK159011R0000	1	11.00



# MC612PA terminal block markers

## Pre-printed marker card for vertical terminal block assembly



MC612PA



6 mm 0.236 in spacing

### Description

Save printing time with our large pre-printed cards offer with pre-printed numbers, letters or symbols.

### Main technical data

Material	Flammability	Dimensions	
		mm	inches
Polyamide	V2	5.6 x 12	0.220 x 0.472

### Ordering details

Description	Number of markers per card	Color	Type	Part Number	Pkg card	Weight (1 pce) g
0->9 (x10)	100	White <input type="checkbox"/>	MC612PA	1SNK150092R0000	1	11.00
1->10 (x10)	100	White <input type="checkbox"/>	MC612PA	1SNK150012R0000	1	11.00
11->20 (x10)	100	White <input type="checkbox"/>	MC612PA	1SNK150022R0000	1	11.00
21->30 (x10)	100	White <input type="checkbox"/>	MC612PA	1SNK150032R0000	1	11.00
31->40 (x10)	100	White <input type="checkbox"/>	MC612PA	1SNK150042R0000	1	11.00
41->50 (x10)	100	White <input type="checkbox"/>	MC612PA	1SNK150052R0000	1	11.00
51->60 (x10)	100	White <input type="checkbox"/>	MC612PA	1SNK150062R0000	1	11.00
61->70 (x10)	100	White <input type="checkbox"/>	MC612PA	1SNK150072R0000	1	11.00
71->80 (x10)	100	White <input type="checkbox"/>	MC612PA	1SNK150082R0000	1	11.00
81->90 (x10)	100	White <input type="checkbox"/>	MC612PA	1SNK150084R0000	1	11.00
91->100 (x10)	100	White <input type="checkbox"/>	MC612PA	1SNK150102R0000	1	11.00
101->110 (x10)	100	White <input type="checkbox"/>	MC612PA	1SNK150112R0000	1	11.00
111->120 (x10)	100	White <input type="checkbox"/>	MC612PA	1SNK150122R0000	1	11.00
121->130 (x10)	100	White <input type="checkbox"/>	MC612PA	1SNK150132R0000	1	11.00
131->140 (x10)	100	White <input type="checkbox"/>	MC612PA	1SNK150142R0000	1	11.00
141->150 (x10)	100	White <input type="checkbox"/>	MC612PA	1SNK150152R0000	1	11.00
151->160 (x10)	100	White <input type="checkbox"/>	MC612PA	1SNK150162R0000	1	11.00
161->170 (x10)	100	White <input type="checkbox"/>	MC612PA	1SNK150172R0000	1	11.00
171->180 (x10)	100	White <input type="checkbox"/>	MC612PA	1SNK150182R0000	1	11.00
181->190 (x10)	100	White <input type="checkbox"/>	MC612PA	1SNK150192R0000	1	11.00
191->200 (x10)	100	White <input type="checkbox"/>	MC612PA	1SNK150202R0000	1	11.00
1->100	100	White <input type="checkbox"/>	MC612PA	1SNK155012R0000	1	11.00
101->200	100	White <input type="checkbox"/>	MC612PA	1SNK155022R0000	1	11.00
201->300	100	White <input type="checkbox"/>	MC612PA	1SNK155032R0000	1	11.00
301->400	100	White <input type="checkbox"/>	MC612PA	1SNK155042R0000	1	11.00
401->500	100	White <input type="checkbox"/>	MC612PA	1SNK155052R0000	1	11.00
501->600	100	White <input type="checkbox"/>	MC612PA	1SNK155062R0000	1	11.00
601->700	100	White <input type="checkbox"/>	MC612PA	1SNK155072R0000	1	11.00
701->800	100	White <input type="checkbox"/>	MC612PA	1SNK155082R0000	1	11.00
801->900	100	White <input type="checkbox"/>	MC612PA	1SNK155092R0000	1	11.00
901->1000	100	White <input type="checkbox"/>	MC612PA	1SNK155102R0000	1	11.00
A (x100)	100	White <input type="checkbox"/>	MC612PA	1SNK156012R0000	1	11.00
B (x100)	100	White <input type="checkbox"/>	MC612PA	1SNK156022R0000	1	11.00
C (x100)	100	White <input type="checkbox"/>	MC612PA	1SNK156032R0000	1	11.00
D (x100)	100	White <input type="checkbox"/>	MC612PA	1SNK156042R0000	1	11.00
E (x100)	100	White <input type="checkbox"/>	MC612PA	1SNK156052R0000	1	11.00
F (x100)	100	White <input type="checkbox"/>	MC612PA	1SNK156062R0000	1	11.00
G (x100)	100	White <input type="checkbox"/>	MC612PA	1SNK156072R0000	1	11.00
H (x100)	100	White <input type="checkbox"/>	MC612PA	1SNK156082R0000	1	11.00
I (x100)	100	White <input type="checkbox"/>	MC612PA	1SNK156092R0000	1	11.00
J (x100)	100	White <input type="checkbox"/>	MC612PA	1SNK156102R0000	1	11.00
K (x100)	100	White <input type="checkbox"/>	MC612PA	1SNK156112R0000	1	11.00
L (x100)	100	White <input type="checkbox"/>	MC612PA	1SNK156122R0000	1	11.00
M (x100)	100	White <input type="checkbox"/>	MC612PA	1SNK156132R0000	1	11.00
N (x100)	100	White <input type="checkbox"/>	MC612PA	1SNK156142R0000	1	11.00
O (x100)	100	White <input type="checkbox"/>	MC612PA	1SNK156152R0000	1	11.00
P (x100)	100	White <input type="checkbox"/>	MC612PA	1SNK156162R0000	1	11.00
Q (x100)	100	White <input type="checkbox"/>	MC612PA	1SNK156172R0000	1	11.00
R (x100)	100	White <input type="checkbox"/>	MC612PA	1SNK156182R0000	1	11.00
S (x100)	100	White <input type="checkbox"/>	MC612PA	1SNK156192R0000	1	11.00
T (x100)	100	White <input type="checkbox"/>	MC612PA	1SNK156202R0000	1	11.00
U (x100)	100	White <input type="checkbox"/>	MC612PA	1SNK156212R0000	1	11.00
V (x100)	100	White <input type="checkbox"/>	MC612PA	1SNK156222R0000	1	11.00
W (x100)	100	White <input type="checkbox"/>	MC612PA	1SNK156232R0000	1	11.00
X (x100)	100	White <input type="checkbox"/>	MC612PA	1SNK156242R0000	1	11.00

Continue on next page →

1SNK160008S0201 - Rev. A

## MC612PA terminal block markers

### Pre-printed marker card for vertical terminal block assembly



MC612PA



6 mm 0.236 in spacing

#### Ordering details

Description	Number of markers per card	Color	Type	Part Number	Pkg card	Weight (1 pce) g
← Continuation of previous page						
Y (x100)	100	White	<input type="checkbox"/> MC612PA	1SNK156252R0000	1	11.00
Z (x100)	100	White	<input type="checkbox"/> MC612PA	1SNK156262R0000	1	11.00
0 (x100)	100	White	<input type="checkbox"/> MC612PA	1SNK157002R0000	1	11.00
1 (x100)	100	White	<input type="checkbox"/> MC612PA	1SNK157012R0000	1	11.00
2 (x100)	100	White	<input type="checkbox"/> MC612PA	1SNK157022R0000	1	11.00
3 (x100)	100	White	<input type="checkbox"/> MC612PA	1SNK157032R0000	1	11.00
4 (x100)	100	White	<input type="checkbox"/> MC612PA	1SNK157042R0000	1	11.00
5 (x100)	100	White	<input type="checkbox"/> MC612PA	1SNK157052R0000	1	11.00
6 (x100)	100	White	<input type="checkbox"/> MC612PA	1SNK157062R0000	1	11.00
7 (x100)	100	White	<input type="checkbox"/> MC612PA	1SNK157072R0000	1	11.00
8 (x100)	100	White	<input type="checkbox"/> MC612PA	1SNK157082R0000	1	11.00
9 (x100)	100	White	<input type="checkbox"/> MC612PA	1SNK157092R0000	1	11.00
+ (x100)	100	White	<input type="checkbox"/> MC612PA	1SNK158002R0000	1	11.00
- (x100)	100	White	<input type="checkbox"/> MC612PA	1SNK158012R0000	1	11.00
~ (x100)	100	White	<input type="checkbox"/> MC612PA	1SNK158022R0000	1	11.00
= (x100)	100	White	<input type="checkbox"/> MC612PA	1SNK158032R0000	1	11.00
± (x100)	100	White	<input type="checkbox"/> MC612PA	1SNK158042R0000	1	11.00
L1 (x100)	100	White	<input type="checkbox"/> MC612PA	1SNK158052R0000	1	11.00
L2 (x100)	100	White	<input type="checkbox"/> MC612PA	1SNK158062R0000	1	11.00
L3 (x100)	100	White	<input type="checkbox"/> MC612PA	1SNK158072R0000	1	11.00
PE (x100)	100	White	<input type="checkbox"/> MC612PA	1SNK158092R0000	1	11.00
U1 (x100)	100	White	<input type="checkbox"/> MC612PA	1SNK158102R0000	1	11.00
U2 (x100)	100	White	<input type="checkbox"/> MC612PA	1SNK158112R0000	1	11.00
U3 (x100)	100	White	<input type="checkbox"/> MC612PA	1SNK158122R0000	1	11.00
V1 (x100)	100	White	<input type="checkbox"/> MC612PA	1SNK158132R0000	1	11.00
V2 (x100)	100	White	<input type="checkbox"/> MC612PA	1SNK158142R0000	1	11.00
V3 (x100)	100	White	<input type="checkbox"/> MC612PA	1SNK158152R0000	1	11.00
W1 (x100)	100	White	<input type="checkbox"/> MC612PA	1SNK158162R0000	1	11.00
W2 (x100)	100	White	<input type="checkbox"/> MC612PA	1SNK158172R0000	1	11.00
W3 (x100)	100	White	<input type="checkbox"/> MC612PA	1SNK158182R0000	1	11.00
+24V (x100)	100	White	<input type="checkbox"/> MC612PA	1SNK158192R0000	1	11.00
+48V (x100)	100	White	<input type="checkbox"/> MC612PA	1SNK158202R0000	1	11.00
-24V (x100)	100	White	<input type="checkbox"/> MC612PA	1SNK158212R0000	1	11.00
-48V (x100)	100	White	<input type="checkbox"/> MC612PA	1SNK158222R0000	1	11.00
L1-L2-L3-N-PE (x20)	100	White	<input type="checkbox"/> MC612PA	1SNK159002R0000	1	11.00
U1-U2-U3-V1-V2-V3-W1-W2-W3 (x10) + U1 (x10)	100	White	<input type="checkbox"/> MC612PA	1SNK159012R0000	1	11.00

## MC812 terminal block markers

Blank card in polycarbonate or polyamide - 8 mm 0.315 in spacing



MC812



HTP500-V2

## MC812 terminal block markers

### Description

- MC812 marker card in polycarbonate for high marking quality, durability and speed when marked with the HTP500 printer,
- Excellent marking durability in the most severe environments,
- Improved marking visibility thanks to the increased marking surface +20% (12 mm 0.472 in)

### Main technical data

Material	Flammability	Maximum printed digits				Dimensions	
		mm		inches			
Polycarbonate	V0	Horizontal	4	Vertical	8	7.6 x 12	0.299 x 0.472

### Ordering details

Description	Number of markers per card	Color	Type	Part number	Pkg card	Weight (1 pce) g
Blank card	30	White <input type="checkbox"/>	MC812	1SNK160000R0000	22	10.00
		Yellow <input checked="" type="checkbox"/>	MC812-YL	1SNK160004R0000	22	10.00



MC812PA



AMS 600

## MC812PA terminal block markers

### Description

- MC812PA marker card in polyamide to be marked on AMS 600 marking table for medium scale volumes and standard industrial applications,
- Terminal blocks are directly independent after strip mounting,
- Improved marking visibility thanks to the increased marking surface +20% (12 mm 0.472 in)

### Main technical data

Material	Flammability	Maximum printed digits				Dimensions	
		mm		inches			
Polyamide	V2	Horizontal	3	Vertical	8	7.6 x 12	0.299 x 0.472

### Ordering details

Description	Number of markers per card	Color	Type	Part number	Pkg card	Weight (1 pce) g
Blank card	100	White <input type="checkbox"/>	MC812PA	1SNK169999R0000	20	14.00

### Marking systems

Description	Type	Part number	Pkg qty	Weight (1 pce) g
AMS plotter	AMS 600 KIT	1SNA360000R2400	1	12600.00

### Marking systems accessories

Description	Type	Part number	Pkg qty	Weight (1 pce) g
Marking support plate for MC PA marker cards (3 MC PA marker cards per plate)	SPRC 30-3	1SNA360039R1700	1	300.00

# MC812PA terminal block markers

## Pre-printed marker card for horizontal terminal block assembly



MC812PA



8 mm 0.315 in spacing

### Description

Save printing time with our large pre-printed cards offer with pre-printed numbers, letters or symbols.

### Main technical data

Material	Flammability	Dimensions	
		mm	inches
Polyamide	V2	7.6 x 12	0.299 x 0.472

### Ordering details

Description	Number of markers per card	Color	Type	Part Number	Pkg card	Weight (1 pce) g
0->9 (x10)	100	White <input type="checkbox"/>	MC812PA	1SNK160091R0000	1	14.00
1->10 (x10)	100	White <input type="checkbox"/>	MC812PA	1SNK160011R0000	1	14.00
11->20 (x10)	100	White <input type="checkbox"/>	MC812PA	1SNK160021R0000	1	14.00
21->30 (x10)	100	White <input type="checkbox"/>	MC812PA	1SNK160031R0000	1	14.00
31->40 (x10)	100	White <input type="checkbox"/>	MC812PA	1SNK160041R0000	1	14.00
41->50 (x10)	100	White <input type="checkbox"/>	MC812PA	1SNK160051R0000	1	14.00
51->60 (x10)	100	White <input type="checkbox"/>	MC812PA	1SNK160061R0000	1	14.00
61->70 (x10)	100	White <input type="checkbox"/>	MC812PA	1SNK160071R0000	1	14.00
71->80 (x10)	100	White <input type="checkbox"/>	MC812PA	1SNK160081R0000	1	14.00
81->90 (x10)	100	White <input type="checkbox"/>	MC812PA	1SNK160083R0000	1	14.00
91->100 (x10)	100	White <input type="checkbox"/>	MC812PA	1SNK160101R0000	1	14.00
101->110 (x10)	100	White <input type="checkbox"/>	MC812PA	1SNK160111R0000	1	14.00
111->120 (x10)	100	White <input type="checkbox"/>	MC812PA	1SNK160121R0000	1	14.00
121->130 (x10)	100	White <input type="checkbox"/>	MC812PA	1SNK160131R0000	1	14.00
131->140 (x10)	100	White <input type="checkbox"/>	MC812PA	1SNK160141R0000	1	14.00
141->150 (x10)	100	White <input type="checkbox"/>	MC812PA	1SNK160151R0000	1	14.00
151->160 (x10)	100	White <input type="checkbox"/>	MC812PA	1SNK160161R0000	1	14.00
161->170 (x10)	100	White <input type="checkbox"/>	MC812PA	1SNK160171R0000	1	14.00
171->180 (x10)	100	White <input type="checkbox"/>	MC812PA	1SNK160181R0000	1	14.00
181->190 (x10)	100	White <input type="checkbox"/>	MC812PA	1SNK160191R0000	1	14.00
191->200 (x10)	100	White <input type="checkbox"/>	MC812PA	1SNK160201R0000	1	14.00
1->100	100	White <input type="checkbox"/>	MC812PA	1SNK165011R0000	1	14.00
101->200	100	White <input type="checkbox"/>	MC812PA	1SNK165021R0000	1	14.00
201->300	100	White <input type="checkbox"/>	MC812PA	1SNK165031R0000	1	14.00
301->400	100	White <input type="checkbox"/>	MC812PA	1SNK165041R0000	1	14.00
401->500	100	White <input type="checkbox"/>	MC812PA	1SNK165051R0000	1	14.00
501->600	100	White <input type="checkbox"/>	MC812PA	1SNK165061R0000	1	14.00
601->700	100	White <input type="checkbox"/>	MC812PA	1SNK165071R0000	1	14.00
701->800	100	White <input type="checkbox"/>	MC812PA	1SNK165081R0000	1	14.00
801->900	100	White <input type="checkbox"/>	MC812PA	1SNK165091R0000	1	14.00
A (x100)	100	White <input type="checkbox"/>	MC812PA	1SNK166011R0000	1	14.00
B (x100)	100	White <input type="checkbox"/>	MC812PA	1SNK166021R0000	1	14.00
C (x100)	100	White <input type="checkbox"/>	MC812PA	1SNK166031R0000	1	14.00
D (x100)	100	White <input type="checkbox"/>	MC812PA	1SNK166041R0000	1	14.00
E (x100)	100	White <input type="checkbox"/>	MC812PA	1SNK166051R0000	1	14.00
F (x100)	100	White <input type="checkbox"/>	MC812PA	1SNK166061R0000	1	14.00
G (x100)	100	White <input type="checkbox"/>	MC812PA	1SNK166071R0000	1	14.00
H (x100)	100	White <input type="checkbox"/>	MC812PA	1SNK166081R0000	1	14.00
I (x100)	100	White <input type="checkbox"/>	MC812PA	1SNK166091R0000	1	14.00
J (x100)	100	White <input type="checkbox"/>	MC812PA	1SNK166101R0000	1	14.00
K (x100)	100	White <input type="checkbox"/>	MC812PA	1SNK166111R0000	1	14.00
L (x100)	100	White <input type="checkbox"/>	MC812PA	1SNK166121R0000	1	14.00
M (x100)	100	White <input type="checkbox"/>	MC812PA	1SNK166131R0000	1	14.00
N (x100)	100	White <input type="checkbox"/>	MC812PA	1SNK166141R0000	1	14.00
O (x100)	100	White <input type="checkbox"/>	MC812PA	1SNK166151R0000	1	14.00
P (x100)	100	White <input type="checkbox"/>	MC812PA	1SNK166161R0000	1	14.00
Q (x100)	100	White <input type="checkbox"/>	MC812PA	1SNK166171R0000	1	14.00
R (x100)	100	White <input type="checkbox"/>	MC812PA	1SNK166181R0000	1	14.00
S (x100)	100	White <input type="checkbox"/>	MC812PA	1SNK166191R0000	1	14.00
T (x100)	100	White <input type="checkbox"/>	MC812PA	1SNK166201R0000	1	14.00
U (x100)	100	White <input type="checkbox"/>	MC812PA	1SNK166211R0000	1	14.00
V (x100)	100	White <input type="checkbox"/>	MC812PA	1SNK166221R0000	1	14.00

Continue on next page →

1SNK160010S0201 - Rev. A

## MC812PA terminal block markers

Pre-printed marker card for horizontal terminal block assembly



MC812PA



8 mm 0.315 in spacing

### Ordering details

Description	Number of markers per card	Color	Type	Part Number	Pkg card	Weight (1 pce) g
← Continuation of previous page						
W (x100)	100	White <input type="checkbox"/>	MC812PA	1SNK166231R0000	1	14.00
X (x100)	100	White <input type="checkbox"/>	MC812PA	1SNK166241R0000	1	14.00
Y (x100)	100	White <input type="checkbox"/>	MC812PA	1SNK166251R0000	1	14.00
Z (x100)	100	White <input type="checkbox"/>	MC812PA	1SNK166261R0000	1	14.00
0 (x100)	100	White <input type="checkbox"/>	MC812PA	1SNK167001R0000	1	14.00
1 (x100)	100	White <input type="checkbox"/>	MC812PA	1SNK167011R0000	1	14.00
2 (x100)	100	White <input type="checkbox"/>	MC812PA	1SNK167021R0000	1	14.00
3 (x100)	100	White <input type="checkbox"/>	MC812PA	1SNK167031R0000	1	14.00
4 (x100)	100	White <input type="checkbox"/>	MC812PA	1SNK167041R0000	1	14.00
5 (x100)	100	White <input type="checkbox"/>	MC812PA	1SNK167051R0000	1	14.00
6 (x100)	100	White <input type="checkbox"/>	MC812PA	1SNK167061R0000	1	14.00
7 (x100)	100	White <input type="checkbox"/>	MC812PA	1SNK167071R0000	1	14.00
8 (x100)	100	White <input type="checkbox"/>	MC812PA	1SNK167081R0000	1	14.00
9 (x100)	100	White <input type="checkbox"/>	MC812PA	1SNK167091R0000	1	14.00
+ (x100)	100	White <input type="checkbox"/>	MC812PA	1SNK168001R0000	1	14.00
- (x100)	100	White <input type="checkbox"/>	MC812PA	1SNK168011R0000	1	14.00
~ (x100)	100	White <input type="checkbox"/>	MC812PA	1SNK168021R0000	1	14.00
= (x100)	100	White <input type="checkbox"/>	MC812PA	1SNK168031R0000	1	14.00
≠ (x100)	100	White <input type="checkbox"/>	MC812PA	1SNK168041R0000	1	14.00
L1 (x100)	100	White <input type="checkbox"/>	MC812PA	1SNK168051R0000	1	14.00
L2 (x100)	100	White <input type="checkbox"/>	MC812PA	1SNK168061R0000	1	14.00
L3 (x100)	100	White <input type="checkbox"/>	MC812PA	1SNK168071R0000	1	14.00
PE (x100)	100	White <input type="checkbox"/>	MC812PA	1SNK168091R0000	1	14.00
U1 (x100)	100	White <input type="checkbox"/>	MC812PA	1SNK168101R0000	1	14.00
U2 (x100)	100	White <input type="checkbox"/>	MC812PA	1SNK168111R0000	1	14.00
U3 (x100)	100	White <input type="checkbox"/>	MC812PA	1SNK168121R0000	1	14.00
V1 (x100)	100	White <input type="checkbox"/>	MC812PA	1SNK168131R0000	1	14.00
V2 (x100)	100	White <input type="checkbox"/>	MC812PA	1SNK168141R0000	1	14.00
V3 (x100)	100	White <input type="checkbox"/>	MC812PA	1SNK168151R0000	1	14.00
W1 (x100)	100	White <input type="checkbox"/>	MC812PA	1SNK168161R0000	1	14.00
W2 (x100)	100	White <input type="checkbox"/>	MC812PA	1SNK168171R0000	1	14.00
W3 (x100)	100	White <input type="checkbox"/>	MC812PA	1SNK168181R0000	1	14.00
L1-L2-L3-N-PE (x20)	100	White <input type="checkbox"/>	MC812PA	1SNK169001R0000	1	14.00
U1-U2-U3-V1-V2-V3-W1-W2-W3 (x10) + U1 (x10)	100	White <input type="checkbox"/>	MC812PA	1SNK169011R0000	1	14.00



# MC812PA terminal block markers

## Pre-printed marker card for vertical terminal block assembly



MC812PA



8 mm 0.315 in spacing

### Description

Save printing time with our large pre-printed cards offer with pre-printed numbers, letters or symbols.

### Main technical data

Material	Flammability	Dimensions	
		mm	inches
Polyamide	V2	7.6 x 12	0.299 x 0.472

### Ordering details

Description	Number of markers per card	Color	Type	Part Number	Pkg card	Weight (1 pce) g
0->9 (x10)	100	White <input type="checkbox"/>	MC812PA	1SNK160092R0000	1	14.00
1->10 (x10)	100	White <input type="checkbox"/>	MC812PA	1SNK160012R0000	1	14.00
11->20 (x10)	100	White <input type="checkbox"/>	MC812PA	1SNK160022R0000	1	14.00
21->30 (x10)	100	White <input type="checkbox"/>	MC812PA	1SNK160032R0000	1	14.00
31->40 (x10)	100	White <input type="checkbox"/>	MC812PA	1SNK160042R0000	1	14.00
41->50 (x10)	100	White <input type="checkbox"/>	MC812PA	1SNK160052R0000	1	14.00
51->60 (x10)	100	White <input type="checkbox"/>	MC812PA	1SNK160062R0000	1	14.00
61->70 (x10)	100	White <input type="checkbox"/>	MC812PA	1SNK160072R0000	1	14.00
71->80 (x10)	100	White <input type="checkbox"/>	MC812PA	1SNK160082R0000	1	14.00
81->90 (x10)	100	White <input type="checkbox"/>	MC812PA	1SNK160084R0000	1	14.00
91->100 (x10)	100	White <input type="checkbox"/>	MC812PA	1SNK160102R0000	1	14.00
101->110 (x10)	100	White <input type="checkbox"/>	MC812PA	1SNK160112R0000	1	14.00
111->120 (x10)	100	White <input type="checkbox"/>	MC812PA	1SNK160122R0000	1	14.00
121->130 (x10)	100	White <input type="checkbox"/>	MC812PA	1SNK160132R0000	1	14.00
131->140 (x10)	100	White <input type="checkbox"/>	MC812PA	1SNK160142R0000	1	14.00
141->150 (x10)	100	White <input type="checkbox"/>	MC812PA	1SNK160152R0000	1	14.00
151->160 (x10)	100	White <input type="checkbox"/>	MC812PA	1SNK160162R0000	1	14.00
161->170 (x10)	100	White <input type="checkbox"/>	MC812PA	1SNK160172R0000	1	14.00
171->180 (x10)	100	White <input type="checkbox"/>	MC812PA	1SNK160182R0000	1	14.00
181->190 (x10)	100	White <input type="checkbox"/>	MC812PA	1SNK160192R0000	1	14.00
191->200 (x10)	100	White <input type="checkbox"/>	MC812PA	1SNK160202R0000	1	14.00
1->100	100	White <input type="checkbox"/>	MC812PA	1SNK165012R0000	1	14.00
101->200	100	White <input type="checkbox"/>	MC812PA	1SNK165022R0000	1	14.00
201->300	100	White <input type="checkbox"/>	MC812PA	1SNK165032R0000	1	14.00
301->400	100	White <input type="checkbox"/>	MC812PA	1SNK165042R0000	1	14.00
401->500	100	White <input type="checkbox"/>	MC812PA	1SNK165052R0000	1	14.00
501->600	100	White <input type="checkbox"/>	MC812PA	1SNK165062R0000	1	14.00
601->700	100	White <input type="checkbox"/>	MC812PA	1SNK165072R0000	1	14.00
701->800	100	White <input type="checkbox"/>	MC812PA	1SNK165082R0000	1	14.00
801->900	100	White <input type="checkbox"/>	MC812PA	1SNK165092R0000	1	14.00
901->1000	100	White <input type="checkbox"/>	MC812PA	1SNK165102R0000	1	14.00
A (x100)	100	White <input type="checkbox"/>	MC812PA	1SNK166012R0000	1	14.00
B (x100)	100	White <input type="checkbox"/>	MC812PA	1SNK166022R0000	1	14.00
C (x100)	100	White <input type="checkbox"/>	MC812PA	1SNK166032R0000	1	14.00
D (x100)	100	White <input type="checkbox"/>	MC812PA	1SNK166042R0000	1	14.00
E (x100)	100	White <input type="checkbox"/>	MC812PA	1SNK166052R0000	1	14.00
F (x100)	100	White <input type="checkbox"/>	MC812PA	1SNK166062R0000	1	14.00
G (x100)	100	White <input type="checkbox"/>	MC812PA	1SNK166072R0000	1	14.00
H (x100)	100	White <input type="checkbox"/>	MC812PA	1SNK166082R0000	1	14.00
I (x100)	100	White <input type="checkbox"/>	MC812PA	1SNK166092R0000	1	14.00
J (x100)	100	White <input type="checkbox"/>	MC812PA	1SNK166102R0000	1	14.00
K (x100)	100	White <input type="checkbox"/>	MC812PA	1SNK166112R0000	1	14.00
L (x100)	100	White <input type="checkbox"/>	MC812PA	1SNK166122R0000	1	14.00
M (x100)	100	White <input type="checkbox"/>	MC812PA	1SNK166132R0000	1	14.00
N (x100)	100	White <input type="checkbox"/>	MC812PA	1SNK166142R0000	1	14.00
O (x100)	100	White <input type="checkbox"/>	MC812PA	1SNK166152R0000	1	14.00
P (x100)	100	White <input type="checkbox"/>	MC812PA	1SNK166162R0000	1	14.00
Q (x100)	100	White <input type="checkbox"/>	MC812PA	1SNK166172R0000	1	14.00
R (x100)	100	White <input type="checkbox"/>	MC812PA	1SNK166182R0000	1	14.00
S (x100)	100	White <input type="checkbox"/>	MC812PA	1SNK166192R0000	1	14.00
T (x100)	100	White <input type="checkbox"/>	MC812PA	1SNK166202R0000	1	14.00
U (x100)	100	White <input type="checkbox"/>	MC812PA	1SNK166212R0000	1	14.00
V (x100)	100	White <input type="checkbox"/>	MC812PA	1SNK166222R0000	1	14.00

Continue on next page →

1SNK160011S0201 - Rev. A

## MC812PA terminal block markers

Pre-printed marker card for vertical terminal block assembly



MC812PA



8 mm 0.315 in spacing

### Ordering details

Description	Number of markers per card	Color	Type	Part Number	Pkg card	Weight (1 pce) g
← Continuation of previous page						
W (x100)	100	White <input type="checkbox"/>	MC812PA	1SNK166232R0000	1	14.00
X (x100)	100	White <input type="checkbox"/>	MC812PA	1SNK166242R0000	1	14.00
Y (x100)	100	White <input type="checkbox"/>	MC812PA	1SNK166252R0000	1	14.00
Z (x100)	100	White <input type="checkbox"/>	MC812PA	1SNK166262R0000	1	14.00
0 (x100)	100	White <input type="checkbox"/>	MC812PA	1SNK167002R0000	1	14.00
1 (x100)	100	White <input type="checkbox"/>	MC812PA	1SNK167012R0000	1	14.00
2 (x100)	100	White <input type="checkbox"/>	MC812PA	1SNK167022R0000	1	14.00
3 (x100)	100	White <input type="checkbox"/>	MC812PA	1SNK167032R0000	1	14.00
4 (x100)	100	White <input type="checkbox"/>	MC812PA	1SNK167042R0000	1	14.00
5 (x100)	100	White <input type="checkbox"/>	MC812PA	1SNK167052R0000	1	14.00
6 (x100)	100	White <input type="checkbox"/>	MC812PA	1SNK167062R0000	1	14.00
7 (x100)	100	White <input type="checkbox"/>	MC812PA	1SNK167072R0000	1	14.00
8 (x100)	100	White <input type="checkbox"/>	MC812PA	1SNK167082R0000	1	14.00
9 (x100)	100	White <input type="checkbox"/>	MC812PA	1SNK167092R0000	1	14.00
+ (x100)	100	White <input type="checkbox"/>	MC812PA	1SNK168002R0000	1	14.00
- (x100)	100	White <input type="checkbox"/>	MC812PA	1SNK168012R0000	1	14.00
~ (x100)	100	White <input type="checkbox"/>	MC812PA	1SNK168022R0000	1	14.00
= (x100)	100	White <input type="checkbox"/>	MC812PA	1SNK168032R0000	1	14.00
± (x100)	100	White <input type="checkbox"/>	MC812PA	1SNK168042R0000	1	14.00
L1 (x100)	100	White <input type="checkbox"/>	MC812PA	1SNK168052R0000	1	14.00
L2 (x100)	100	White <input type="checkbox"/>	MC812PA	1SNK168062R0000	1	14.00
L3 (x100)	100	White <input type="checkbox"/>	MC812PA	1SNK168072R0000	1	14.00
PE (x100)	100	White <input type="checkbox"/>	MC812PA	1SNK168092R0000	1	14.00
U1 (x100)	100	White <input type="checkbox"/>	MC812PA	1SNK168102R0000	1	14.00
U2 (x100)	100	White <input type="checkbox"/>	MC812PA	1SNK168112R0000	1	14.00
U3 (x100)	100	White <input type="checkbox"/>	MC812PA	1SNK168122R0000	1	14.00
V1 (x100)	100	White <input type="checkbox"/>	MC812PA	1SNK168132R0000	1	14.00
V2 (x100)	100	White <input type="checkbox"/>	MC812PA	1SNK168142R0000	1	14.00
V3 (x100)	100	White <input type="checkbox"/>	MC812PA	1SNK168152R0000	1	14.00
W1 (x100)	100	White <input type="checkbox"/>	MC812PA	1SNK168162R0000	1	14.00
W2 (x100)	100	White <input type="checkbox"/>	MC812PA	1SNK168172R0000	1	14.00
W3 (x100)	100	White <input type="checkbox"/>	MC812PA	1SNK168182R0000	1	14.00
+24V (x100)	100	White <input type="checkbox"/>	MC812PA	1SNK168192R0000	1	14.00
+48V (x100)	100	White <input type="checkbox"/>	MC812PA	1SNK168202R0000	1	14.00
-24V (x100)	100	White <input type="checkbox"/>	MC812PA	1SNK168212R0000	1	14.00
-48V (x100)	100	White <input type="checkbox"/>	MC812PA	1SNK168222R0000	1	14.00
L1-L2-L3-N-PE (x20)	100	White <input type="checkbox"/>	MC812PA	1SNK169002R0000	1	14.00
U1-U2-U3-V1-V2-V3-W1-W2-W3 (x10) + U1 (x10)	100	White <input type="checkbox"/>	MC812PA	1SNK169012R0000	1	14.00

# UMH universal wire markers holder - MG2-TDMO clip-on blank wire marker

## Markers and marking systems



5.2 mm 0.205 in spacing

### Mounting instructions



Install the UMH on the terminal blocks (strip mounting) and slide on the wire markers.

## UMH universal wire markers holder

### Description

- Compatible with MG2 - TDMO wire markers and most of the wire markers available on the market (wire markers not supplied with UMH);
- Quickly put it on any SNK terminal blocks and accessories: strip mounting of 10 parts for 5.2 mm 0.205 in spacing, unitary mounting for other spacings.

### Ordering details

Description	Color	Type	Part Number	Pkg qty	Weight (1 pce) g
5.2 mm 0.205 in spacing	Grey <input type="checkbox"/>	UMH	1SNK900611R0000	10	0.20

### Main technical data

Material specifications	Insulating material	Polyamide		
	Flammability	V0		
	NF F 16 101	I2F2		
Ambient temperature min/max	Service IEC 60068-2-1	-55 ... +110 °C	-67 ... +230 °F	
	Storage	-55 ... +110 °C	-67 ... +230 °F	
	Installing	-5 ... +40 °C	-23 ... +104 °F	

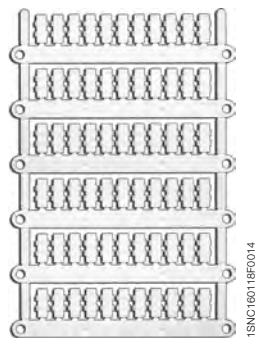

MG2-TDMO

## MG2-TDMO clip-on blank wire marker

### Description

- Rigid Polycarbonate marker to be directly printed and snapped on the wire or the UMH wire marker holder,
- Print with support plate MG2-PTM.

### Main technical data

Material	Flammability	Temperature range
PC	V0	-40°C ... +140°C, - 22°F ... +176°F

### Ordering details

Dimensions mm	in	Number of markers per card	Color	Type	Part Number	SW code	Pkg qty	Weight (1 pce) g
<b>MG2-TDMO-01</b>								
4 x 12	0.157 x 0.472	40	White <input type="checkbox"/>	MG2-TDMO-01	40390	1SNB040390R0412	125	880
4 x 16	0.157 x 0.630	40	White <input type="checkbox"/>	MG2-TDMO-01	40391	1SNB040391R0416	128	880
4 x 12	0.157 x 0.472	40	Yellow <input checked="" type="checkbox"/>	MG2-TDMO-01	40340	1SNB040340R0412	125	800
4 x 16	0.157 x 0.630	40	Yellow <input checked="" type="checkbox"/>	MG2-TDMO-01	40341	1SNB040341R0416	128	800
<b>MG2-TDMO-02</b>								
4 x 12	0.157 x 0.472	40	White <input type="checkbox"/>	MG2-TDMO-02	40490	1SNB040490R0412	126	640
4 x 16	0.157 x 0.630	40	White <input type="checkbox"/>	MG2-TDMO-02	40491	1SNB040491R0416	129	640
4 x 12	0.157 x 0.472	40	Yellow <input checked="" type="checkbox"/>	MG2-TDMO-02	40440	1SNB040440R0412	126	640
4 x 16	0.157 x 0.630	40	Yellow <input checked="" type="checkbox"/>	MG2-TDMO-02	40441	1SNB040441R0416	129	640
<b>MG2-TDMO-03</b>								
4 x 12	0.157 x 0.472	40	White <input type="checkbox"/>	MG2-TDMO-03	40590	1SNB040590R0412	127	560
4 x 16	0.157 x 0.630	40	White <input type="checkbox"/>	MG2-TDMO-03	40591	1SNB040591R0416	130	560
4 x 12	0.157 x 0.472	40	Yellow <input checked="" type="checkbox"/>	MG2-TDMO-03	40540	1SNB040540R0412	127	560
4 x 16	0.157 x 0.630	40	Yellow <input checked="" type="checkbox"/>	MG2-TDMO-03	40541	1SNB040541R0416	130	560

### Marking system

MG3 KIT	AMS 250	AMS 600	HTP500		
<input checked="" type="checkbox"/>	<input type="checkbox"/>	<input type="checkbox"/>	<input type="checkbox"/>		
Description	Support status	Type	Part Number	Pkg qty	Weight (1 pce) g
<b>Support plate</b>					
Support plate for cable tags MG2-TDMO & MG-TDM 4x16mm	Purchased separately	MG2-PTM 991010	1SNB991010R0000	1	116.00



MG3 KIT

## Markers for components

### Markers and marking systems

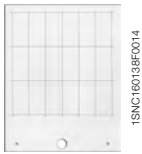

MG-TAR

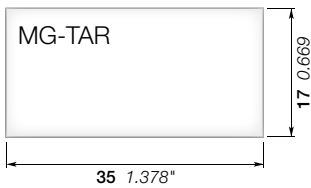
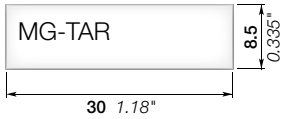

## MG-TAR markers for components

### Description

Identify your terminal blocks assembly with the precut blank label adapted to the LH label holders.

### Ordering details

Description	Nb. of markers per card	Nb. of card by package	Color	Type	Part Number	SW code	Pkg	Weight
For LH label holder	33	50	White <input type="checkbox"/>	MG-TAR 45490	1SNB045490R8530	720	marker	1 marker <b>g</b>
For LH-R1 label holder	18	50		MG-TAR 45194	1SNB045194R1735	711		900 0.628

### Main technical data

Material specifications	Insulating material	Rigid PVC					
	Flammability	V0					
	NF F 16 101						
Ambient temperature min/max	Service IEC 60068-2-1	-30 ... +80 °C	-22 ... +176 °F				
	Storage	-30 ... +80 °C	-22 ... +176 °F				
	Installing	+10 ... +40 °C	+50 ... +104 °F				



MG-TAA

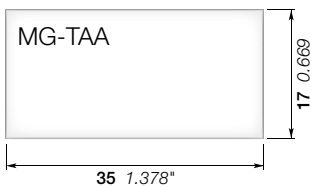
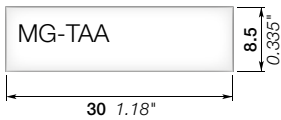

## MG-TAA markers for components

### Description

Identify your terminal blocks assembly with the self adhesive label adapted to the LH label holders.

### Ordering details

Description	Nb. of markers per card	Nb. of card by package	Color	Type	Part Number	SW code	Pkg	Weight
For LH label holder	33	25	White <input type="checkbox"/>	MG-TAA 49498	1SNB049498R8530	33	marker	1 marker <b>g</b>
	33	25	Yellow <input type="checkbox"/>	MG-TAA 49448	1SNB049448R8530	33		825 0.55
For LH-R1 label holder	18	25	White <input type="checkbox"/>	MG-TAA 49198	1SNB049198R1735	711		450 0.91
	18	25	Yellow <input type="checkbox"/>	MG-TAA 49148	1SNB049148R1735	711		450 0.91

### Main technical data

Material specifications	Insulating material	Rigid PVC					
	Flammability	V0					
	NF F 16 101						
Ambient temperature min/max	Service IEC 60068-2-1	-30 ... +80 °C	-22 ... +176 °F				
	Storage	-30 ... +80 °C	-22 ... +176 °F				
	Installing	+10 ... +40 °C	+50 ... +104 °F				



### Marking system & accessories

Description	Color	Type	Part Number	Pkg	Weight
Thermal transfer printer	Grey <input type="checkbox"/>	MG3 KIT	1SNB419001R0000	1	12600 (1 pce) <b>g</b>

## Markers for components

### Markers and marking systems



MG-TAPW

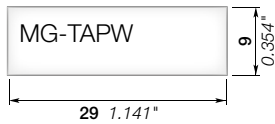

## MG-TAPW markers for components

### Description

Identify your terminal blocks assembly with the precut blank label adapted to the LH label holders.

### Ordering details

Description	Nb. of markers per card	Nb. of card by package	Color	Type	Part Number	SW code	Pkg	Weight
For LH label holder	30	50	White <input type="checkbox"/>	MG-TAPW 49096	1SNB049096R0929	363	marker	1 marker g
	30	50	Yellow <input type="checkbox"/>	MG-TAPW 49046	1SNB049046R0929	363	marker	1 marker g

### Main technical data

Material specifications	Insulating material	Rigid PVC				
	Flammability	V0				
Ambient temperature min/max	NF F 16 101					
	Service IEC 60068-2-1	-30 ... +80 °C	-22 ... +176 °F			
	Storage	-30 ... +80 °C	-22 ... +176 °F			
	Installing	+10 ... +40 °C	+50 ... +104 °F			



### Marking system & accessories

Description	Color	Type	Part Number	Pkg	Weight
Thermal transfer printer	Grey <input type="checkbox"/>	MG3 KIT	1SNB419001R0000	1 qty	(1 pce) g 12600

1SNK160100S0201



# Label

## Markers and marking systems

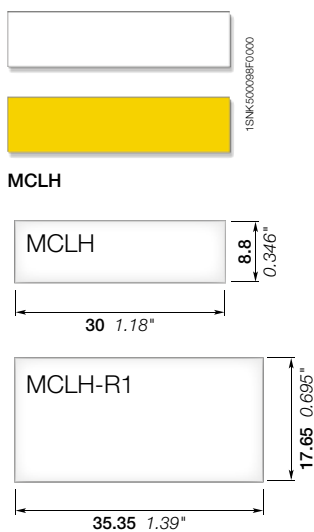

### MCLH label

#### Description

Identify your terminal blocks assembly with the self adhesive label adapted to the LH label holders.

#### Ordering details

Description	Nb. of markers per card	Nb. of card by package	Color	Type	Part Number	SW code	Pkg	Weight
For LH label holder	36	25	White □	MCLH	1SNK900630R0000		card	1 card <b>g</b>
			Yellow ■	MCLH-YL	1SNK900633R0000		25	10.00
For LH-R1 label holder	15	25	White □	MCLH-R1	1SNK900631R0000		25	10.00
			Yellow ■	MCLH-R1-YL	1SNK900634R0000		25	10.00

#### Main technical data

Material specifications	Insulating material	PVC + adhesive acrylic				
	Flammability	V0				
	NF F 16 101					
Ambient temperature min/max	Service IEC 60068-2-1	-55 ... +110 °C	-67 ... +230 °F			
	Storage	-55 ... +110 °C	-67 ... +230 °F			
	Installing	-5 ... +40 °C	+23 ... +104 °F			

#### Marking system & accessories

Description	Color	Type	Part Number	Pkg	Weight
1 Plotter		AMS 600 KIT	1SNA36000R2400	1	12600.00
2 Support plate for AMS		SPRC 21	1SNA360031R0600	1	851.00

Complete list of accessories is indicated in the terminal block datasheet including end stops. Some accessories such as jumper bars may modify the terminal block's ratings: Complete information available in the accessories section of the catalog.

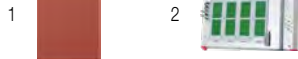

# HTP500 thermal transfer printer

## Consumables



HTP500-CLEAN



HTP500-FEED



HTP500-PL2



RIB-B

### Feeders and support plates

Description	Color	Type	Part Number	Pkg qty	Weight (1 pce) g
Universal feeder for marker cards		HTP500-FEED	1SNA235703R0400	1	
Support plate for TE Connectivity terminal block markers		HTP500-PL2	1SNA235705R0600	1	
Universal support plate for wire markers		HTP500-PL	1SNA235704R0500	1	

### Accessories

Description	Color	Type	Part Number	Pkg qty	Weight (1 pce) g
Black ribbon cassette		RIB-B	1SNA235710R0600	3	
Red ribbon cassette for identification plates and adhesive labels		RIB-R	1SNA235711R2300	3	
Red ribbon cassette for terminal blocks and wire markers		RIB-RS	1SNA235718R0200	3	
Cleaning cassette		HTP500-CLEAN	1SNA235714R2600	1	
Standard cleaning roll ø18		HTP500-ROLL	1SNA235715R2700	1	
Printing head		HTP500-PRINT	1SNA235716R2000	1	
Dust cover for HTP500 and AMS 600 systems		DUST COVER	1SNA360161R1500	1	
Wooden box for HTP500-V2 KIT		HTP500-WB	1SNA235717R2100	1	
Software CD		HTS500	1SNA235702R0300	1	
Support table		HTP500-BAS	1SNA235706R0700	1	
Power supply cable		HTP500-PW	1SNA235709R1200	1	

# MG3 thermal transfer printer

## Kit and accessories



MG3 KIT

### Description

- Versatile,
- Compact and robust,
- Easy to install and use.

### Ordering details

Description	Color	Type	Part Number	Pkg pce	Weight (1 pce) g
MG3 Thermal transfer printer KIT		MG3 KIT	1SNB419001R0000	1	12600.00
<b>List of items included in the KIT:</b>					
1 MG3 Thermal transfer printer		MG3			
1 Software CD		MG3 SOFTWARE			
1 Power supply cable		MG3 POWER			
1 USB cable		MG3 USB			
1 Protective cover		MG2 COVE 991680			
1 Ribbon take up spool		MG2-CRB 991654			
1 Black monochrome ribbon		MG2-ETR 991600			
1 Support plate for cable tags MG-TPM		MG2-PWC 991000			
1 Support plate for labels, cables, plates and various markers		MG2-PLT 991002			
1 Support plate for terminal block markers MG-CPM-01(5x10 and 5x15),02,03,04,07		MG2-QTB 991011			
1 Support plate for SNK series terminal block markers (MG-CPM-13)		MG2-ETB 991016			



Support plate MG2-...

### Support plates

Description	Color	Type	Part Number	Pkg pce	Weight (1 pce) g
Support template for:					
Cable tags MG-TPM		MG2-PWC 991000	1SNB991000R0000	1	148.00
Labels, cable tags, plates and various markers		MG2-PLT 991002	1SNB991002R0000	1	148.00
Terminal block markers MG-CPM-05,12		MG2-WTB 991004	1SNB991004R0000	1	151.00
Terminal block markers MG-CPM-06		MG2-STB 991005	1SNB991005R0000	1	158.00
Terminal block markers MG-CPM-10		MG2-CTB 991006	1SNB991006R0000	1	156.00
Cable tags MG-TDM (4x12 mm)		MG2-PTD 991007	1SNB991007R0000	1	126.00
Terminal block markers MG-CPM-01 (5x7 mm)		MG2-MTB 991008	1SNB991008R0000	1	149.00
Cable tags MG2-TDMO and MG-TDM (4x16 mm)		MG2-PTM 991010	1SNB991010R0000	1	116.00
Terminal block markers MG-CPM-01 (5x10 and 5x15 mm),02,03,04,07		MG2-QTB 991011	1SNB991011R0000	1	120.00
Terminal block markers TE Connectivity RC and MC series		MG2-ABM 991012	1SNB991012R0000	1	146.00
Terminal block markers MG-CPM-09		MG2-LTB 991013	1SNB991013R0000	1	128.00
Terminal block markers SNK series MG-CPM-13		MG2-ETB 991016	1SNB991016R0000	1	100.00

### PET blank cover for support plate

Description	Color	Type	Part Number	Pkg pce	Weight (1 pce) g
PET blank for support plate MG2-PWC		MG2-TWC 991502	1SNB991502R0000	3	16.70
PET blank for support plate MG2-PLT		MG2-TLT 991522	1SNB991522R0000	3	14.70
PET blank for support plate MG2-PTD		MG2-TTD 991563	1SNB991563R0000	3	11.70
PET blank for support plate MG2-MTB		MG2-TMT 991513	1SNB991513R0000	3	12.00
PET blank for support plate MG2-WTB		MG2-TWT 991542	1SNB991542R0000	3	12.00
PET blank for support plate MG2-STB		MG2-TST 991552	1SNB991552R0000	3	21.50
PET blank for support plate MG2-CTB		MG2-TCT 991562	1SNB991562R0000	3	12.00
PET blank for support plate MG2-QTB		MG2-TGT 991532	1SNB991532R0000	3	11.70
PET blank for support plate MG2-ETB		MG2-TTB 991512	1SNB991512R0000	3	10.70

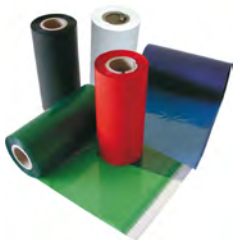

Ribbons MG2-ETR...

### Accessories

Description	Color	Type	Part Number	Pkg pce	Weight (1 pce) g
Print head cleaning kit		MG2-CKP 991670	1SNB991670R0000	1	336.00
Black monochrome ribbon	Black ■	MG2-ETR 991600	1SNB991600R0000	1	227.00
Blue monochrome ribbon	Blue ■	MG2-ETR 991601	1SNB991601R0000	1	229.00
Red monochrome ribbon	Red ■	MG2-ETR 991602	1SNB991602R0000	1	255.00
Green monochrome ribbon	Green ■	MG2-ETR 991603	1SNB991603R0000	1	247.00
White monochrome ribbon	White □	MG2-ETR 991606	1SNB991606R0000	1	333.00

# AMS plotter

## Kit and accessories



AMS 600

### AMS 600

#### Description

- For basic marking applications,
- Economic,
- Full-size format,
- Print original manufacturers' markers.

#### Ordering details

Description	Color	Type	Part Number	Pkg pce	Weight (1 pce) g
AMS 600 Plotter KIT		AMS 600 KIT	1SNA36000R2400	1	12600
<b>List of items included in the KIT:</b>					
1 AMS 600 plotter pen printer		AMS 600			
1 Software CD		AMS SOFTWARE			
1 Power supply cable		AMS POWER			
1 USB cable		AMS USB			
1 Support plate for RC / MC / RCTT / WMTT / BA4 / RCT		SPRC1			
1 Support plate for MC...PA		SPRC 30-3			
1 Plotter pen Ø 0.25 mm .01 in		AMS PEN 0.25			
1 Plotter pen Ø 0.35 mm .014 in		AMS PEN 0.35			
5 Ink cartridges		AMS INK CARTRIDGES			
1 Cleaner fluid		AMS CLEANER FLUID			
1 Cleaner kit		AMS CLEANER KIT			



AMS 250

### AMS 250

#### Description

- Basic needs,
- Economic,
- Half-size format
- Compatible with most of AMS 600 accessories.

#### Ordering details

Description	Color	Type	Part Number	Pkg pce	Weight (1 pce) g
AMS 250 Plotter KIT		AMS 250 BASIC KIT	1SNA36000R2500	1	8800
<b>List of items included in the KIT:</b>					
1 AMS 250 plotter pen printer		AMS 250 BASIC			
1 Software CD		AMS SOFTWARE			
1 Power supply cable		AMS POWER			
1 USB cable		AMS USB			
1 Support plate for BA4 / MC / RC / RCAL / RCT / RCTT		SPRC2			
1 Disposable plotter pen Ø 0.25 mm .01 in EDR ink		DISPOSABLE AMS PEN ED-R 0.25			
1 Disposable plotter pen Ø 0.35 mm .014 in EDR ink		DISPOSABLE AMS PEN ED-R 0.35			

# AMS plotter Kit and accessories

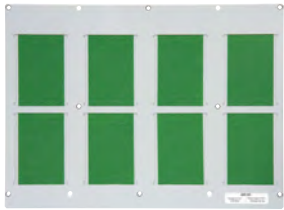

SPRC1



SPRC2

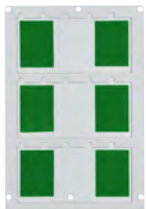

SPRC30-3

## Support plates for TE Connectivity markers

Description	Compatibility		Type	Part Number	Pkg pce	Weight (1 pce) g
	AMS 500 AMS 600	AMS 250				
Support plates for:						
RC/MC/RCTT/WMTT/BA4/RCT full format	●		SPRC 1	1SNA360010R1500	1	1500.00
RC/MC/RCTT/WMTT/BA4/RCT		●	SPRC 2	1SNA360011R1500	1	600.00
RB strips	●	●	SPRC 4	1SNA360014R0500	1	300.00
RTM7-9	●		SPRC 5	1SNA360015R0600	1	1700.00
PIB	●	●	SPRC 13	1SNA360023R0600	1	260.00
BA5-50	●	●	SPRC 14	1SNA360024R0700	1	300.00
RC-X10A	●	●	SPRC 15	1SNA360025R0000	1	300.00
2 RC cards	●	●	SPRC 16	1SNA360026R0100	1	300.00
WM markers	●	●	SPRC 26	1SNA360036R0300	1	300.00
PAM strip	●	●	SPRC 27	1SNA360037R0400	1	300.00
RPCV markers	●	●	SPRC 28	1SNA360040R2300	1	300.00
RCL, P, W510	●	●	SPRC 29	1SNA360038R1500	1	300.00
MC... PA	●	●	SPRC 30-3	1SNA360039R1700	1	500.00
A4 universal support plate	●	●	SPRC 21	1SNA360031R0600	1	500.00

## Support plates for other manufacturers

Description	Compatibility		Type	Part Number	Pkg pce	Weight (1 pce) g
	AMS 500 AMS 600	AMS 250				
Support plates for markers:						
Wieland	●	●	SPRC 6	1SNA360016R0700	1	350.00
Weidmüller	●	●	SPRC 7	1SNA360017R0000	1	400.00
Phoenix ZBM 5/6	●	●	SPRC 8	1SNA360018R1100	1	300.00
Phoenix ZB	●	●	SPRC 9	1SNA360019R1200	1	300.00
Allen Bradley WRZ	●	●	SPRC 10	1SNA360020R1700	1	330.00
Wago mini WSB5	●	●	SPRC 11	1SNA360021R0400	1	300.00

## Accessories

Description	Diameter Color	Type	Part Number	Pkg pce	Weight (1 pce) g	
Plotter pen P 2.0 black ink	Ø 0.18 mm 0.007 in	Red ■	AMS PEN 0.18	1SNA360103R1400	1	15.00
	Ø 0.25 mm 0.01 in	White □	AMS PEN 0.25	1SNA360100R2500	1	15.00
	Ø 0.35 mm 0.014 in	Yellow ■	AMS PEN 0.35	1SNA360101R1200	1	15.00
	Ø 0.50 mm 0.02 in	Brown ■	AMS PEN 0.50	1SNA360104R1500	1	26.00
	Ø 0.70 mm 0.028 in	Blue ■	AMS PEN 0.70	1SNA360105R1600	1	26.00
	Ø 1.00 mm 0.039 in	Orange ■	AMS PEN 1.00	1SNA360106R1700	1	26.00
Disposable plotter pen P 2.0 black ink	Ø 0.25 mm 0.01 in	White □	DISPOSABLE AMS PEN 0.25	1SNA360120R1000	1	24.00
	Ø 0.35 mm 0.014 in	Yellow ■	DISPOSABLE AMS PEN 0.35	1SNA360121R0500	1	24.00
Disposable plotter pen ED-R black ink	Ø 0.18 mm 0.007 in	Red ■	DISPOSABLE AMS PEN ED-R 0.18	1SNA360124R1000	1	24.00
	Ø 0.25 mm 0.01 in	White □	DISPOSABLE AMS PEN ED-R 0.25	1SNA360122R1000	1	24.00
	Ø 0.35 mm 0.014 in	Yellow ■	DISPOSABLE AMS PEN ED-R 0.35	1SNA360123R0500	1	24.00
5 ink cartridges 1 ml		AMS INK CARTRIDGES	1SNA360150R2600	1	18.00	
2 cleaner fluid bottles, 2x10 ml		AMS CLEANER FLUID	1SNA360155R1700	1	40.00	
Cleaner kit including: 1 rinse bottle and 1 blotting paper		AMS CLEANER KIT	1SNA360156R1000	1	34.00	
Dust cover		DUST COVER	1SNA360161R1500	1	200.00	
Service kit for pen maintenance		SERVICE KIT FOR AMS 600	1SNA360162R1600	1	12.00	
Self-adhesive support for support plate SPRC 1		SPDST1	1SNA360163R1700	1	70.00	
Plotter head for AMS 600 including 1 printing module, 1 pen holder and 1 dust cover		PEN HOLDER	1SNA360098R1200	1	85.00	



AMS PEN



AMS CLEANER KIT



AMS INK CARTRIDGES





# Index

## Part Number classification

Part Number	Type	Page	Part Number	Type	Page	Part Number	Type	Page
1SNA113542R1000	PC5-2	105	1SNA360156R1000	AMS CLEANER KIT	268	1SNK140084R0000	MC512PA	248
1SNA113544R1200	PC5-10	105	1SNA360161R1500	DUST COVER	265	1SNK140091R0000	MC512PA	246
1SNA116538R1700	PC8-2	226	1SNA360162R1600	SERVICE KIT FOR AMS 500	268	1SNK140092R0000	MC512PA	248
1SNA116539R1000	PC8-3	226	1SNA360163R1700	SPDST1	268	1SNK140101R0000	MC512PA	246
1SNA116540R2500	PC8-4	226	1SNA399726R0700	EPR2	201	1SNK140102R0000	MC512PA	248
1SNA163313R2400	PC8-10	155	1SNA399787R0500	CPBP2	92	1SNK140111R0000	MC512PA	246
1SNA164800R0300	PR3.G2	197	1SNA399788R1600	CPBP1	91	1SNK140112R0000	MC512PA	248
1SNA168500R1200	PR4	198	1SNA400711R0600	PC8-R1	153	1SNK140121R0000	MC512PA	246
1SNA168672R1100	TGA8	120	1SNA400712R0700	PC8-R2	155	1SNK140122R0000	MC512PA	248
1SNA168673R1200	TGA8	120	1SNA400713R0000	PC8-R3	155	1SNK140131R0000	MC512PA	246
1SNA168674R1300	TGA8	120	1SNA400724R0300	PC8-R4	155	1SNK140132R0000	MC512PA	248
1SNA168675R1400	ANT	120	1SNA400842R0000	PC8-R5	155	1SNK140141R0000	MC512PA	246
1SNA168700R2200	PR5	198	1SNA400843R0000	PC8-R6	155	1SNK140142R0000	MC512PA	248
1SNA173220R0500	PR30	196	1SNA400849R0000	PC8-R7	155	1SNK140151R0000	MC512PA	246
1SNA173523R1100	PC81-10	120	1SNA400850R0000	PC8-R8	155	1SNK140152R0000	MC512PA	248
1SNA174300R1700	PR3.Z2	196	1SNB040340R0412	MG2-TDMO-01 40340	261	1SNK140161R0000	MC512PA	246
1SNA178430R0500	RCPBEB	201	1SNB040341R0416	MG2-TDMO-01 40341	261	1SNK140162R0000	MC512PA	248
1SNA178431R2200	EPR1	201	1SNB040390R0412	MG2-TDMO-01 40390	261	1SNK140171R0000	MC512PA	246
1SNA178529R0400	PR50	197	1SNB040391R0416	MG2-TDMO-01 40391	261	1SNK140172R0000	MC512PA	248
1SNA179371R1600	CN5	120	1SNB040440R0412	MG2-TDMO-02 40440	261	1SNK140181R0000	MC512PA	246
1SNA179726R0200	AJS9	152	1SNB040441R0416	MG2-TDMO-02 40441	261	1SNK140182R0000	MC512PA	248
1SNA206053R0700	BJMI31.2	91	1SNB040490R0412	MG2-TDMO-02 40490	261	1SNK140191R0000	MC512PA	246
1SNA206054R0000	BJMI31.3	91	1SNB040491R0416	MG2-TDMO-02 40491	261	1SNK140192R0000	MC512PA	248
1SNA206126R2500	BJMI36.2	92	1SNB040540R0412	MG2-TDMO-03 40540	261	1SNK140201R0000	MC512PA	246
1SNA206223R0600	BJMI36.3	92	1SNB040541R0416	MG2-TDMO-03 40541	261	1SNK140202R0000	MC512PA	248
1SNA206680R1500	AJS9-BK	154	1SNB040590R0412	MG2-TDMO-03 40590	261	1SNK145011R0000	MC512PA	246
1SNA206681R0200	AJS9-GN	154	1SNB040591R0416	MG2-TDMO-03 40591	261	1SNK145012R0000	MC512PA	248
1SNA206682R0300	AJS9-GR	154	1SNB041740R0512	MG-CPM 13 41740	244	1SNK145021R0000	MC512PA	246
1SNA206683R0400	AJS9-BL	154	1SNB041741R0612	MG-CPM 13 41741	250	1SNK145022R0000	MC512PA	248
1SNA206720R1400	AJS9-RD	154	1SNB041790R0512	MG-CPM 13 41790	21	1SNK145031R0000	MC512PA	246
1SNA206721R0100	AL4-M3	152	1SNB041791R0612	MG-CPM 13 41791	30	1SNK145032R0000	MC512PA	248
1SNA206765R0000	AJS9-WH	154	1SNB043196R0012	MG-CPMFA 43196	185	1SNK145041R0000	MC512PA	246
1SNA206772R0000	AJS9-PR	154	1SNB045194R1735	MG-TAR 45194	201	1SNK145042R0000	MC512PA	248
1SNA206782R0000	AJS9-BR	154	1SNB045490R8530	MG-TAR 45490	201	1SNK145051R0000	MC512PA	246
1SNA235106R2600	PAM43020	230	1SNB046415R0615	MG-VYT 46415	217	1SNK145052R0000	MC512PA	248
1SNA235155R2600	PIB2-TT	201	1SNB046915R0615	MG-VYT 46915	217	1SNK145061R0000	MC512PA	246
1SNA235157R2000	PIB2-TT-YL	201	1SNB049046R0929	MG-TAPW 49046	263	1SNK145062R0000	MC512PA	248
1SNA235158R0100	RCPEAD-TT	201	1SNB049096R0929	MG-TAPW 49096	263	1SNK145102R0000	MC512PA	246
1SNA235159R0200	RCPEAD-TT-YL	201	1SNB049148R1735	MG-TAA 49148	201	1SNK145072R0000	MC512PA	248
1SNA235702R0300	HTS500	265	1SNB049198R1735	MG-TAA 49198	201	1SNK145081R0000	MC512PA	246
1SNA235703R0400	HTP500-FEED	265	1SNB049448R8530	MG-TAA 49448	201	1SNK145082R0000	MC512PA	248
1SNA235704R0500	HTP500-PL	265	1SNB049498R8530	MG-TAA 49498	201	1SNK145091R0000	MC512PA	246
1SNA235705R0600	HTP500-PL2	265	1SNB419001R0000	MG3 KIT	244	1SNK145092R0000	MC512PA	248
1SNA235706R0700	HTP500-BAS	265	1SNB991000R0000	MG2-PWC 991000	266	1SNK145102R0000	MC512PA	246
1SNA235709R1200	HTP500-PW	265	1SNB991002R0000	MG2-PLT 991002	266	1SNK146011R0000	MC512PA	248
1SNA235710R0600	RIB-B	265	1SNB991004R0000	MG2-WTB 991004	266	1SNK146012R0000	MC512PA	246
1SNA235711R2300	RIB-R	265	1SNB991005R0000	MG2-STB 991005	266	1SNK146021R0000	MC512PA	248
1SNA235714R2600	HTP500-CLEAN	265	1SNB991006R0000	MG2-CTB 991006	266	1SNK146022R0000	MC512PA	246
1SNA235715R2700	HTP500-ROLL	265	1SNB991007R0000	MG2-PTD 991007	266	1SNK146031R0000	MC512PA	248
1SNA235716R2000	HTP500-PRINT	265	1SNB991008R0000	MG2-MTB 991008	266	1SNK146032R0000	MC512PA	246
1SNA235717R2100	HTP500-WB	265	1SNB991010R0000	MG2-PTM 991010	261	1SNK146041R0000	MC512PA	248
1SNA235718R0200	RIB-RS	265	1SNB991011R0000	MG2-QTB 991011	266	1SNK146042R0000	MC512PA	246
1SNA238000R1600	RC1010	91	1SNB991012R0000	MG2-ABM 991012	266	1SNK146051R0000	MC512PA	248
1SNA360000R2400	AMS 600 KIT	245	1SNB991013R0000	MG2-LTB 991013	266	1SNK146052R0000	MC512PA	246
1SNA360000R2500	AMS 250 BASIC KIT	267	1SNB991016R0000	MG2-ETB 991016	244	1SNK146061R0000	MC512PA	248
1SNA360010R1500	SPRC 1	268	1SNB991502R0000	MG2-TWC 991502	266	1SNK146062R0000	MC512PA	246
1SNA360011R1500	SPRC 2	268	1SNB991512R0000	MG2-TTB 991512	266	1SNK146071R0000	MC512PA	248
1SNA360014R0500	SPRC 4	268	1SNB991513R0000	MG2-TMT 991513	266	1SNK146072R0000	MC512PA	246
1SNA360015R0600	SPRC 5	268	1SNB991522R0000	MG2-TLT 991522	266	1SNK146081R0000	MC512PA	248
1SNA360016R0700	SPRC 6	268	1SNB991532R0000	MG2-TGT 991532	266	1SNK146082R0000	MC512PA	246
1SNA360017R0000	SPRC 7	268	1SNB991542R0000	MG2-TWT 991542	266	1SNK146091R0000	MC512PA	248
1SNA360018R1100	SPRC 8	268	1SNB991552R0000	MG2-TST 991552	266	1SNK146092R0000	MC512PA	246
1SNA360019R1200	SPRC 9	268	1SNB991562R0000	MG2-TCT 991562	266	1SNK146101R0000	MC512PA	248
1SNA360020R1700	SPRC 10	268	1SNB991563R0000	MG2-TTD 991563	266	1SNK146102R0000	MC512PA	246
1SNA360021R0400	SPRC 11	268	1SNB991600R0000	MG2-ETR 991600	266	1SNK146111R0000	MC512PA	248
1SNA360023R0600	SPRC 13	268	1SNB991601R0000	MG2-ETR 991601	266	1SNK146112R0000	MC512PA	246
1SNA360024R0700	SPRC 14	268	1SNB991602R0000	MG2-ETR 991602	266	1SNK146121R0000	MC512PA	248
1SNA360025R0000	SPRC 15	268	1SNB991603R0000	MG2-ETR 991603	266	1SNK146122R0000	MC512PA	246
1SNA360026R0100	SPRC 16	268	1SNB991606R0000	MG2-ETR 991606	266	1SNK146131R0000	MC512PA	248
1SNA360031R0600	SPRC 21	264	1SNB991670R0000	MG2-CKP 991670	266	1SNK146132R0000	MC512PA	246
1SNA360036R0300	SPRC 26	268	1SNK140000R0000	MC512	21	1SNK146141R0000	MC512PA	248
1SNA360037R0400	SPRC 27	268	1SNK140004R0000	MC512-YL	244	1SNK146142R0000	MC512PA	246
1SNA360038R1500	SPRC 29	268	1SNK140011R0000	MC512PA	246	1SNK146151R0000	MC512PA	248
1SNA360039R1700	SPRC 30-3	245	1SNK140012R0000	MC512PA	248	1SNK146152R0000	MC512PA	246
1SNA360040R2300	SPRC 28	268	1SNK140021R0000	MC512PA	246	1SNK146161R0000	MC512PA	248
1SNA360098R1200	PEN HOLDER	268	1SNK140022R0000	MC512PA	248	1SNK146162R0000	MC512PA	246
1SNA360100R2500	AMS PEN 0.25	268	1SNK140031R0000	MC512PA	246	1SNK146171R0000	MC512PA	248
1SNA360101R1200	AMS PEN 0.35	268	1SNK140032R0000	MC512PA	248	1SNK146172R0000	MC512PA	246
1SNA360103R1400	AMS PEN 0.18	268	1SNK140041R0000	MC512PA	246	1SNK146181R0000	MC512PA	248
1SNA360104R1500	AMS PEN 0.50	268	1SNK140042R0000	MC512PA	248	1SNK146182R0000	MC512PA	246
1SNA360105R1600	AMS PEN 0.70	268	1SNK140051R0000	MC512PA	246	1SNK146191R0000	MC512PA	248
1SNA360106R1700	AMS PEN 1.00	268	1SNK140052R0000	MC512PA	248	1SNK146192R0000	MC512PA	246
1SNA360120R1000	DISPOSABLE AMS PEN 0.25	268	1SNK140061R0000	MC512PA	246	1SNK146201R0000	MC512PA	248
1SNA360121R0500	DISPOSABLE AMS PEN 0.35	268	1SNK140062R0000	MC512PA	248	1SNK146202R0000	MC512PA	246
1SNA360122R1000	DISPOSABLE AMS PEN ED-R.0.25	268	1SNK140071R0000	MC512PA	246	1SNK146211R0000	MC512PA	248
1SNA360123R0500	DISPOSABLE AMS PEN ED-R.0.35	268	1SNK140072R0000	MC512PA	248	1SNK146212R0000	MC512PA	246
1SNA360124R1000	DISPOSABLE AMS PEN ED-R.0.18	268	1SNK140081R0000	MC512PA	246	1SNK146221R0000	MC512PA	248
1SNA360150R2600	AMS INK CARTRIDGES	268	1SNK140082R0000	MC512PA	248	1SNK146222R0000	MC512PA	246
1SNA360155R1700	AMS CLEANER FLUID	268	1SNK140083R0000	MC512PA	246	1SNK146231R0000	MC512PA	248





# Index

## Part Number classification

Part Number	Type	Page	Part Number	Type	Page	Part Number	Type	Page
1SNK160072R0000	MC812PA	259	1SNK166212R0000	MC812PA	259	1SNK505212R0000	ZS4-T3	146
1SNK160081R0000	MC812PA	257	1SNK166221R0000	MC812PA	257	1SNK505214R0000	ZS4-D-CH-UD	148
1SNK160082R0000	MC812PA	259	1SNK166222R0000	MC812PA	259	1SNK505215R0000	ZS4-D-CH-DU	149
1SNK160083R0000	MC812PA	257	1SNK166231R0000	MC812PA	258	1SNK505220R0000	ZS4-D2-BL	136
1SNK160084R0000	MC812PA	259	1SNK166232R0000	MC812PA	260	1SNK505230R0000	ZS4-D2-OR	136
1SNK160091R0000	MC812PA	257	1SNK166241R0000	MC812PA	258	1SNK505310R0000	ZS4-S	105
1SNK160092R0000	MC812PA	259	1SNK166242R0000	MC812PA	260	1SNK505311R0000	ZS4-S-T2	106
1SNK160101R0000	MC812PA	257	1SNK166251R0000	MC812PA	258	1SNK505312R0000	ZS4-S-T2.3	106
1SNK160102R0000	MC812PA	259	1SNK166252R0000	MC812PA	260	1SNK505313R0000	ZS4-SP	112
1SNK160111R0000	MC812PA	257	1SNK166261R0000	MC812PA	258	1SNK505314R0000	ZS4-SP-T2	113
1SNK160112R0000	MC812PA	259	1SNK166262R0000	MC812PA	260	1SNK505315R0000	ZS4-D2-S	142
1SNK160121R0000	MC812PA	257	1SNK167001R0000	MC812PA	258	1SNK505316R0000	ZS4-D2-S-T2	143
1SNK160122R0000	MC812PA	259	1SNK167002R0000	MC812PA	260	1SNK505320R0000	ZS4-S-BL	105
1SNK160131R0000	MC812PA	257	1SNK167011R0000	MC812PA	258	1SNK505321R0000	ZS4-S-T2-BL	106
1SNK160132R0000	MC812PA	259	1SNK167012R0000	MC812PA	260	1SNK505330R0000	ZS4-S-OR	105
1SNK160141R0000	MC812PA	257	1SNK167021R0000	MC812PA	258	1SNK505331R0000	ZS4-S-T2-OR	106
1SNK160142R0000	MC812PA	259	1SNK167022R0000	MC812PA	260	1SNK505910R0000	ES4	80
1SNK160151R0000	MC812PA	257	1SNK167031R0000	MC812PA	258	1SNK505911R0000	ES6-4S	83
1SNK160152R0000	MC812PA	259	1SNK167032R0000	MC812PA	260	1SNK505912R0000	ES6-3S	82
1SNK160161R0000	MC812PA	257	1SNK167041R0000	MC812PA	258	1SNK505960R0000	ES4-D2	136
1SNK160162R0000	MC812PA	259	1SNK167042R0000	MC812PA	260	1SNK505961R0000	ES4-T3	146
1SNK160171R0000	MC812PA	257	1SNK167051R0000	MC812PA	258	1SNK506010R0000	ZS6	81
1SNK160172R0000	MC812PA	259	1SNK167052R0000	MC812PA	260	1SNK506011R0000	ZS6-3S	82
1SNK160181R0000	MC812PA	257	1SNK167061R0000	MC812PA	258	1SNK506012R0000	ZS6-4S	83
1SNK160182R0000	MC812PA	259	1SNK167062R0000	MC812PA	260	1SNK506013R0000	ZS4-R2	130
1SNK160191R0000	MC812PA	257	1SNK167071R0000	MC812PA	258	1SNK506020R0000	ZS6-BL	81
1SNK160192R0000	MC812PA	259	1SNK167072R0000	MC812PA	260	1SNK506021R0000	ZS6-3S-BL	82
1SNK160201R0000	MC812PA	257	1SNK167081R0000	MC812PA	258	1SNK506022R0000	ZS6-4S-BL	83
1SNK160202R0000	MC812PA	259	1SNK167082R0000	MC812PA	260	1SNK506030R0000	ZS6-OR	81
1SNK165011R0000	MC812PA	257	1SNK167091R0000	MC812PA	258	1SNK506060R0000	ZS6-YL	81
1SNK165012R0000	MC812PA	259	1SNK167092R0000	MC812PA	260	1SNK506061R0000	ZS6-GN	81
1SNK165021R0000	MC812PA	257	1SNK168001R0000	MC812PA	258	1SNK506062R0000	ZS6-RD	81
1SNK165022R0000	MC812PA	259	1SNK168002R0000	MC812PA	260	1SNK506063R0000	ZS6-PR	81
1SNK165031R0000	MC812PA	257	1SNK168011R0000	MC812PA	258	1SNK506064R0000	ZS6-BR	81
1SNK165032R0000	MC812PA	259	1SNK168012R0000	MC812PA	260	1SNK506065R0000	ZS6-WH	81
1SNK165041R0000	MC812PA	257	1SNK168021R0000	MC812PA	258	1SNK506066R0000	ZS6-BK	81
1SNK165042R0000	MC812PA	259	1SNK168022R0000	MC812PA	260	1SNK506067R0000	ZS6-3S-YL	82
1SNK165051R0000	MC812PA	257	1SNK168031R0000	MC812PA	258	1SNK506068R0000	ZS6-4S-YL	83
1SNK165052R0000	MC812PA	259	1SNK168032R0000	MC812PA	260	1SNK506150R0000	ZS6-PE	81
1SNK165061R0000	MC812PA	257	1SNK168041R0000	MC812PA	258	1SNK506151R0000	ZS6-3S-PE	82
1SNK165062R0000	MC812PA	259	1SNK168042R0000	MC812PA	260	1SNK506152R0000	ZS6-4S-PE	83
1SNK165071R0000	MC812PA	257	1SNK168051R0000	MC812PA	258	1SNK506153R0000	ZS4-PE-R2	131
1SNK165072R0000	MC812PA	259	1SNK168052R0000	MC812PA	260	1SNK506210R0000	ZS6-D2	138
1SNK165081R0000	MC812PA	257	1SNK168061R0000	MC812PA	258	1SNK506211R0000	ZS6-D1	139
1SNK165082R0000	MC812PA	259	1SNK168062R0000	MC812PA	260	1SNK506212R0000	ZS6-D2-PE	140
1SNK165091R0000	MC812PA	257	1SNK168071R0000	MC812PA	258	1SNK506213R0000	ZS4-T3-R1	147
1SNK165092R0000	MC812PA	259	1SNK168072R0000	MC812PA	260	1SNK506214R0000	ZS6-D1-RD	139
1SNK165102R0000	MC812PA	257	1SNK168091R0000	MC812PA	258	1SNK506220R0000	ZS6-D2-BL	138
1SNK166011R0000	MC812PA	257	1SNK168092R0000	MC812PA	260	1SNK506230R0000	ZS6-D2-OR	138
1SNK166012R0000	MC812PA	259	1SNK168101R0000	MC812PA	258	1SNK506250R0000	ZS6-D1-PE	138
1SNK166021R0000	MC812PA	257	1SNK168102R0000	MC812PA	260	1SNK506260R0000	ZS6-D2-YL	138
1SNK166022R0000	MC812PA	259	1SNK168111R0000	MC812PA	258	1SNK506262R0000	ZS6-D2-RD	138
1SNK166031R0000	MC812PA	257	1SNK168112R0000	MC812PA	260	1SNK506265R0000	ZS6-D2-WH	138
1SNK166032R0000	MC812PA	259	1SNK168121R0000	MC812PA	258	1SNK506266R0000	ZS6-D2-BK	138
1SNK166041R0000	MC812PA	257	1SNK168122R0000	MC812PA	260	1SNK506310R0000	ZS4-S-R1	107
1SNK166042R0000	MC812PA	259	1SNK168131R0000	MC812PA	258	1SNK506311R0000	ZS4-S-T2-R1	108
1SNK166051R0000	MC812PA	257	1SNK168132R0000	MC812PA	260	1SNK506312R0000	ZS4-S-T2.3-R1	108
1SNK166052R0000	MC812PA	259	1SNK168141R0000	MC812PA	258	1SNK506313R0000	ZS4-SP-R1	114
1SNK166061R0000	MC812PA	257	1SNK168142R0000	MC812PA	260	1SNK506314R0000	ZS4-SP-T2-R1	115
1SNK166062R0000	MC812PA	259	1SNK168151R0000	MC812PA	258	1SNK506315R0000	ZS6-S	109
1SNK166071R0000	MC812PA	257	1SNK168152R0000	MC812PA	260	1SNK506316R0000	ZS6-S-4S-T2	110
1SNK166072R0000	MC812PA	259	1SNK168161R0000	MC812PA	258	1SNK506320R0000	ZS4-S-R1-BL	107
1SNK166081R0000	MC812PA	257	1SNK168162R0000	MC812PA	260	1SNK506321R0000	ZS4-S-T2-R1-BL	108
1SNK166082R0000	MC812PA	259	1SNK168171R0000	MC812PA	258	1SNK506322R0000	ZS6-S-BL	109
1SNK166091R0000	MC812PA	257	1SNK168172R0000	MC812PA	260	1SNK506330R0000	ZS4-S-R1-OR	107
1SNK166092R0000	MC812PA	259	1SNK168181R0000	MC812PA	258	1SNK506331R0000	ZS4-S-T2-R1-OR	108
1SNK166101R0000	MC812PA	257	1SNK168182R0000	MC812PA	260	1SNK506410R0000	ZS4-SF	126
1SNK166102R0000	MC812PA	259	1SNK168192R0000	MC812PA	260	1SNK506411R0000	ZS4-SF-T2	127
1SNK166111R0000	MC812PA	257	1SNK168202R0000	MC812PA	260	1SNK506412R0000	ZS4-SF-R1	128
1SNK166112R0000	MC812PA	259	1SNK168212R0000	MC812PA	260	1SNK506413R0000	ZS4-SF-R2	129
1SNK166121R0000	MC812PA	257	1SNK168222R0000	MC812PA	260	1SNK506414R0000	ZS4-S-R2	132
1SNK166122R0000	MC812PA	259	1SNK169001R0000	MC812PA	258	1SNK506415R0000	ZS4-SF-R3	128
1SNK166131R0000	MC812PA	257	1SNK169002R0000	MC812PA	260	1SNK506416R0000	ZS4-SF-R4	129
1SNK166132R0000	MC812PA	259	1SNK169011R0000	MC812PA	258	1SNK508010R0000	ZS10	84
1SNK166141R0000	MC812PA	257	1SNK169012R0000	MC812PA	260	1SNK508011R0000	ZS10-R1	152
1SNK166142R0000	MC812PA	259	1SNK169999R0000	MC812PA	30	1SNK508013R0000	ZS4-R1	124
1SNK166151R0000	MC812PA	257	1SNK505010R0000	ZS4	80	1SNK508020R0000	ZS10-BL	84
1SNK166152R0000	MC812PA	259	1SNK505020R0000	ZS4-BL	80	1SNK508030R0000	ZS10-OR	84
1SNK166161R0000	MC812PA	257	1SNK505030R0000	ZS4-OR	80	1SNK508060R0000	ZS10-YL	84
1SNK166162R0000	MC812PA	259	1SNK505060R0000	ZS4-YL	80	1SNK508061R0000	ZS10-GN	84
1SNK166171R0000	MC812PA	257	1SNK505061R0000	ZS4-GN	80	1SNK508062R0000	ZS10-RD	84
1SNK166172R0000	MC812PA	259	1SNK505062R0000	ZS4-RD	80	1SNK508063R0000	ZS10-PR	84
1SNK166181R0000	MC812PA	257	1SNK505063R0000	ZS4-PR	80	1SNK508064R0000	ZS10-BR	84
1SNK166182R0000	MC812PA	259	1SNK505064R0000	ZS4-BR	80	1SNK508065R0000	ZS10-WH	84
1SNK166191R0000	MC812PA	257	1SNK505065R0000	ZS4-WH	80	1SNK508066R0000	ZS10-BK	84
1SNK166192R0000	MC812PA	259	1SNK505066R0000	ZS4-BK	80	1SNK508150R0000	ZS10-PE	84
1SNK166201R0000	MC812PA	257	1SNK505150R0000	ZS4-PE	80	1SNK508151R0000	ZS10-PE-R1	153
1SNK166202R0000	MC812PA	259	1SNK505210R0000	ZS4-D2	136	1SNK508310R0000	ZS10-ST	154
1SNK166211R0000	MC812PA	257	1SNK505211R0000	ZS4-D1	137	1SNK508311R0000	ZS10-ST-T4	152

Index\_1SNK160027C0206

# Index

## Part Number classification

Part Number	Type	Page	Part Number	Type	Page	Part Number	Type	Page
1SNK508312R0000	ZS10-ST-1	152	1SNK705220R0000	ZK2.5-D2-BL	56	1SNK805213R0000	ZDK2.5-D2	181
1SNK508315R0000	ZS10-S	111	1SNK705250R0000	ZK2.5-D1-PE	56	1SNK805214R0000	ZDK2.5-D1	182
1SNK508316R0000	ZS10-SP	116	1SNK705310R0000	ZK2.5-S	49	1SNK805223R0000	ZDK2.5-D2-BL	181
1SNK508320R0000	ZS10-S-BL	111	1SNK705311R0000	ZK2.5-SP	52	1SNK805250R0000	ZDK2.5-D1-PE	184
1SNK508410R0000	ZS4-SF1	120	1SNK705312R0000	ZK2.5-S-4P	50	1SNK805712R0000	CDK2.5	172
1SNK508411R0000	ZS4-SF1-T2	121	1SNK705313R0000	ZK2.5-SP-4P	53	1SNK805713R0000	CDK2.5-E	172
1SNK508412R0000	ZS4-SF1-R1	122	1SNK705320R0000	ZK2.5-S-BL	49	1SNK805714R0000	CDS4	190
1SNK508413R0000	ZS4-SF1-R2	123	1SNK705321R0000	ZK2.5-S-4P-BL	50	1SNK805715R0000	CDS4-E	190
1SNK508414R0000	ZS4-SF1-R3	122	1SNK705330R0000	ZK2.5-S-OR	49	1SNK805738R0000	CDK2.5-J	186
1SNK508415R0000	ZS4-SF1-R4	123	1SNK705331R0000	ZK2.5-S-4P-OR	50	1SNK805739R0000	CDK2.5-J-E	186
1SNK508416R0000	ZS4-S-R3	125	1SNK705510R0000	ZK2.5-T3	60	1SNK805740R0000	CDK2.5-2P-J	187
1SNK508417R0000	ZS10-S-R2	135	1SNK705511R0000	ZK2.5-T1	61	1SNK805741R0000	CDK2.5-2P-J-E	187
1SNK508418R0000	ZS10-SF	133	1SNK705512R0000	ZK2.5-L-L-PE	62	1SNK805742R0000	CDK2.5-BL	175
1SNK508419R0000	ZS4-S-R3-T2	125	1SNK705513R0000	ZK2.5-L-N-PE	63	1SNK805743R0000	CDK2.5-BL-E	175
1SNK508421R0000	ZS10-SF-R1	134	1SNK705550R0000	ZK2.5-T1-PE	60	1SNK805744R0000	CDK2.5-J-BL	186
1SNK508422R0000	ZS10-SF-R3	134	1SNK705710R0000	ZK2.5-CH-4P-LR	65	1SNK805745R0000	CDK2.5-J-BL-E	186
1SNK508423R0000	ZS4-D2-SF1-R1	145	1SNK705711R0000	ZK2.5-CH-4P-RL	66	1SNK805746R0000	CDK2.5-2P-J-BL	187
1SNK508424R0000	ZS4-D2-SF1-R3	145	1SNK705910R0000	EK2.5	21	1SNK805747R0000	CDK2.5-2P-J-BL-E	187
1SNK508425R0000	ZS4-D2-SF1	144	1SNK705911R0000	EK2.5-3P	22	1SNK805748R0000	CDK2.5-J-PE	186
1SNK508430R0000	ZS4-SF1-OR	120	1SNK705912R0000	EK2.5-4P	23	1SNK805749R0000	CDK2.5-J-PE-E	186
1SNK508910R0000	ES10-ST	152	1SNK705913R0000	EK2.5-S-4P	50	1SNK805750R0000	CDK2.5-PE	174
1SNK508911R0000	ES4-D2-SF1	144	1SNK705960R0000	EK2.5-D2	56	1SNK805751R0000	CDK2.5-2P-J-PE	187
1SNK508960R0000	ES4-SF	120	1SNK705961R0000	EK2.5-T3	60	1SNK805752R0000	CDK2.5-2P-J-PE-E	187
1SNK510010R0000	ZS16	85	1SNK706010R0000	ZK4	24	1SNK805753R0000	CDK2.5-PE-E	174
1SNK510020R0000	ZS16-BL	85	1SNK706011R0000	ZK4-3P	25	1SNK805910R0000	EDK2.5-22	177
1SNK510030R0000	ZS16-OR	85	1SNK706012R0000	ZK4-4P	26	1SNK805911R0000	EDS4-22	190
1SNK510150R0000	ZS16-PE	85	1SNK706020R0000	ZK4-BL	24	1SNK805913R0000	EDK2.5-D	181
1SNK512010R0000	ZS25	86	1SNK706021R0000	ZK4-3P-BL	25	1SNK805914R0000	EDK2.5-21	176
1SNK512020R0000	ZS25-BL	86	1SNK706022R0000	ZK4-4P-BL	26	1SNK805915R0000	EDK2.5-11	172
1SNK512060R0000	ZS25-YL	86	1SNK706030R0000	ZK4-OR	24	1SNK805917R0000	ED2.5-22	173
1SNK512150R0000	ZS25-PE	86	1SNK706031R0000	ZK4-3P-OR	25	1SNK806010R0000	ZDK4-22	178
1SNK516010R0000	ZS35	87	1SNK706032R0000	ZK4-4P-OR	26	1SNK806013R0000	ZDS4-22-R1	192
1SNK516011R0000	ZS50	88	1SNK706060R0000	ZK4-YL	24	1SNK806712R0000	CDK4	178
1SNK516020R0000	ZS35-BL	87	1SNK706062R0000	ZK4-RD	24	1SNK806713R0000	CDK4-E	178
1SNK516021R0000	ZS50-BL	88	1SNK706066R0000	ZK4-BK	24	1SNK806714R0000	CDS4-R1	192
1SNK516030R0000	ZS35-OR	87	1SNK706150R0000	ZK4-PE	24	1SNK900001R0000	BAM4	80
1SNK516060R0000	ZS50-YL	88	1SNK706151R0000	ZK4-PE-3P	25	1SNK900002R0000	BAZ1	30
1SNK516063R0000	ZS50-RD	88	1SNK706152R0000	ZK4-PE-4P	26	1SNK900101R0000	CDS	80
1SNK516064R0000	ZS50-BK	88	1SNK706310R0000	ZK2.5-S-R1	51	1SNK900102R0000	BAZH1	56
1SNK516150R0000	ZS35-PE	87	1SNK706410R0000	ZK2.5-SF	51	1SNK900103R0000	CS-R1	80
1SNK516151R0000	ZS50-PE	88	1SNK706411R0000	ZK2.5-SF-R1	55	1SNK900104R0000	ES-TC8	27
1SNK516170R0000	ZS35-PEN	101	1SNK706412R0000	ZK2.5-SF-R3	55	1SNK900105R0000	ES-TC6	24
1SNK522010R0000	ZS70	89	1SNK708010R0000	ZK6	27	1SNK900106R0000	CS-R2	21
1SNK522020R0000	ZS70-BL	89	1SNK708011R0000	ZK6-3P	28	1SNK900107R0000	CS-R3	30
1SNK522060R0000	ZS70-YL	89	1SNK708020R0000	ZK6-BL	27	1SNK900200R0000	TC5	21
1SNK522150R0000	ZS70-PE	89	1SNK708021R0000	ZK6-3P-BL	28	1SNK900201R0000	TC5-R1	21
1SNK526010R0000	ZS95	90	1SNK708030R0000	ZK6-OR	27	1SNK900203R0000	TP2	30
1SNK526020R0000	ZS95-BL	90	1SNK708031R0000	ZK6-3P-OR	28	1SNK900205R0000	TP4	30
1SNK526060R0000	ZS95-YL	90	1SNK708060R0000	ZK6-YL	27	1SNK900401R0000	PG5	52
1SNK526150R0000	ZS95-PE	90	1SNK708062R0000	ZK6-RD	27	1SNK900402R0000	PG5-R1	52
1SNK531010R0000	ZS150	91	1SNK708066R0000	ZK6-BK	27	1SNK900403R0000	PG5-R2	211
1SNK531020R0000	ZS150-BL	91	1SNK708150R0000	ZK6-PE	27	1SNK900600R0000	SHBS	80
1SNK531060R0000	ZS150-YL	91	1SNK708151R0000	ZK6-PE-3P	28	1SNK900601R0000	SHBP	21
1SNK536010R0000	ZS240	92	1SNK708911R0000	EK6-3P	28	1SNK900602R0000	SHB	56
1SNK536020R0000	ZS240-BL	92	1SNK710010R0000	ZK10	29	1SNK900603R0000	JB85-3	21
1SNK536060R0000	ZS240-YL	92	1SNK710011R0000	ZK10-3P	31	1SNK900604R0000	CO	155
1SNK705010R0000	ZK2.5	21	1SNK710020R0000	ZK10-BL	29	1SNK900605R0000	LH	199
1SNK705011R0000	ZK2.5-3P	22	1SNK710021R0000	ZK10-3P-BL	31	1SNK900606R0000	LH-J	56
1SNK705012R0000	ZK2.5-4P	23	1SNK710030R0000	ZK10-OR	29	1SNK900607R0000	LH-R1	199
1SNK705020R0000	ZK2.5-BL	21	1SNK710063R0000	ZK10-PV	30	1SNK900611R0000	UMH	30
1SNK705021R0000	ZK2.5-3P-BL	22	1SNK710064R0000	ZK10-3P-PV	32	1SNK900618R0000	PL5	80
1SNK705022R0000	ZK2.5-4P-BL	23	1SNK710065R0000	ZK10-PV-BL	30	1SNK900619R0000	PL6	81
1SNK705030R0000	ZK2.5-OR	21	1SNK710067R0000	ZK10-3P-PV-BL	32	1SNK900620R0000	PL8	84
1SNK705031R0000	ZK2.5-3P-OR	22	1SNK710150R0000	ZK10-PE	30	1SNK900621R0000	PL10	85
1SNK705032R0000	ZK2.5-4P-OR	23	1SNK710151R0000	ZK10-PE-3P	32	1SNK900622R0000	PL16	87
1SNK705060R0000	ZK2.5-YL	21	1SNK710910R0000	EK10	29	1SNK900624R0000	KCO	155
1SNK705061R0000	ZK2.5-GN	21	1SNK710911R0000	EK10-3P	31	1SNK900625R0000	PT-3	210
1SNK705062R0000	ZK2.5-RD	21	1SNK712010R0000	ZK16	33	1SNK900627R0000	RLLS	219
1SNK705065R0000	ZK2.5-WH	21	1SNK712011R0000	ZK16-3P	35	1SNK900630R0000	MCLH	201
1SNK705066R0000	ZK2.5-BK	21	1SNK712020R0000	ZK16-BL	33	1SNK900631R0000	MCLH-R1	201
1SNK705067R0000	ZK2.5-3P-YL	22	1SNK712021R0000	ZK16-3P-BL	35	1SNK900633R0000	MCLH-YL	201
1SNK705068R0000	ZK2.5-3P-GN	22	1SNK712063R0000	ZK16-PV	34	1SNK900634R0000	MCLH-R1-YL	201
1SNK705069R0000	ZK2.5-3P-RD	22	1SNK712064R0000	ZK16-3P-PV	36	1SNK900636R0000	COP-ZD	172
1SNK705072R0000	ZK2.5-3P-WH	22	1SNK712065R0000	ZK16-PV-BL	34	1SNK900637R0000	VR-ZD	185
1SNK705073R0000	ZK2.5-3P-BK	22	1SNK712067R0000	ZK16-3P-PV-BL	36	1SNK900640R0000	TO3.5-50	213
1SNK705074R0000	ZK2.5-4P-YL	23	1SNK712150R0000	ZK16-PE	34	1SNK900641R0000	TO4-100	213
1SNK705075R0000	ZK2.5-4P-GN	23	1SNK712151R0000	ZK16-PE-3P	36	1SNK900642R0000	TO5.5-125	213
1SNK705076R0000	ZK2.5-4P-RD	23	1SNK805010R0000	ZDK2.5-22	177	1SNK900643R0000	TO6.5-150	213
1SNK705079R0000	ZK2.5-4P-WH	23	1SNK805013R0000	ZDS4-22	190	1SNK900644R0000	TO3.5-100-INS	213
1SNK705080R0000	ZK2.5-4P-BK	23	1SNK805014R0000	ZDK2.5-21	176	1SNK900650R0000	PS-3	213
1SNK705150R0000	ZK2.5-PE	21	1SNK805015R0000	ZDK2.5-11	175	1SNK900652R0000	SC-JB8-2	152
1SNK705151R0000	ZK2.5-PE-3P	22	1SNK805016R0000	ZD2.5-11	172	1SNK900653R0000	SC-JB8-3	156
1SNK705152R0000	ZK2.5-PE-4P	23	1SNK805017R0000	ZD2.5-22	173	1SNK900654R0000	SC-JB8-4	156
1SNK705210R0000	ZK2.5-D	56	1SNK805020R0000	ZDK2.5-22-BL	177	1SNK900655R0000	SC-JB8-5	231
1SNK705211R0000	ZK2.5-D1	57	1SNK805025R0000	ZDK2.5-11-BL	175	1SNK900657R0000	SC-JB8-3-OR	231
1SNK705212R0000	ZK2.5-D2-PE	58	1SNK805150R0000	ZDK2.5-11-PE	179	1SNK900658R0000	SC-JB8-4-OR	231
1SNK705213R0000	ZK2.5-D-CH-UD	67	1SNK805152R0000	ZDK2.5-22-PE	180	1SNK900659R0000	TO3.5-50-A	213
1SNK705214R0000	ZK2.5-D-CH-DU	68	1SNK805156R0000	ZD2.5-22-PE	174	1SNK900660R0000	PT-ZD	185
1SNK705219R0000	ZK2.5-D-CH2-DU-RL	69	1SNK805212R0000	ZDK2.5-D2-PE	183	1SNK905302R0000	JB5-2	21





# Index

## Part Number classification

Part Number	Type	Page	Part Number	Type	Page	Part Number	Type	Page
1SNK905303R0000	JB5-3	21						
1SNK905304R0000	JB5-4	21						
1SNK905305R0000	JB5-5	21						
1SNK905310R0000	JB5-10	21						
1SNK905350R0000	JB5-50	21						
1SNK906302R0000	JB6-2	24						
1SNK906303R0000	JB6-3	24						
1SNK906304R0000	JB6-4	24						
1SNK906305R0000	JB6-5	24						
1SNK906310R0000	JB6-10	24						
1SNK906350R0000	JB6-50	24						
1SNK908302R0000	JB8-2	27						
1SNK908303R0000	JB8-3	27						
1SNK908304R0000	JB8-4	27						
1SNK908305R0000	JB8-5	27						
1SNK908310R0000	JB8-10	27						
1SNK908902R0000	JB8-2-R1	154						
1SNK908903R0000	JB8-3-R1	154						
1SNK908904R0000	JB8-4-R1	154						
1SNK908905R0000	JB8-5-R1	154						
1SNK908910R0000	JB8-10-R1	154						
1SNK910302R0000	JB10-2	29						
1SNK910303R0000	JB10-3	29						
1SNK910304R0000	JB10-4	29						
1SNK910305R0000	JB10-5	29						
1SNK910310R0000	JB10-10	29						
1SNK912302R0000	JB12-2	30						
1SNK912303R0000	JB12-3	30						
1SNK912305R0000	JB12-5	30						
1SNK916302R0000	JB16-2	87						
1SNK916303R0000	JB16-3	87						
1SNK916304R0000	JB16-4	87						
1SNK916305R0000	JB16-5	87						
1SNK916310R0000	JB16-10	87						
1SNK922302R0000	JB22-2	89						
1SNK922303R0000	JB22-3	89						
1SNK922305R0000	JB22-5	89						
1SNK922310R0000	JB22-10	89						
1SNK926302R0000	JB26-2	90						
1SNK926303R0000	JB26-3	90						
1SNK926305R0000	JB26-5	90						
1SNK926310R0000	JB26-10	90						

# Index

## Type classification

Type	Part Number	Page	Type	Part Number	Page	Type	Part Number	Page
AJS9	1SNA179726R0200	152	ES4-T3	1SNK505961R0000	146	1SNK140122R0000	248	
AJS9-BK	1SNA206680R1500	154	ES6-3S	1SNK505912R0000	82	1SNK140131R0000	246	
AJS9-BL	1SNA206683R0400	154	ES6-4S	1SNK505911R0000	83	1SNK140132R0000	248	
AJS9-BR	1SNA206782R0000	154	ES-TC6	1SNK900105R0000	24	1SNK140141R0000	246	
AJS9-GN	1SNA206681R0200	154	ES-TC8	1SNK900104R0000	27	1SNK140142R0000	248	
AJS9-GR	1SNA206682R0300	154	HTP500-BAS	1SNA235706R0700	265	1SNK140151R0000	246	
AJS9-PR	1SNA206772R0000	154	HTP500-CLEAN	1SNA235714R2600	265	1SNK140152R0000	248	
AJS9-RD	1SNA206720R1400	154	HTP500-FEED	1SNA235703R0400	265	1SNK140161R0000	246	
AJS9-WH	1SNA206765R0000	154	HTP500-PL	1SNA235704R0500	265	1SNK140162R0000	248	
AL4-M3	1SNA206721R0100	152	HTP500-PL2	1SNA235705R0600	265	1SNK140171R0000	246	
AMS 250 BASIC KIT	1SNA360000R2500	267	HTP500-PRINT	1SNA235716R2000	265	1SNK140172R0000	248	
AMS 600 KIT	1SNA360000R2400	245	HTP500-PW	1SNA235709R1200	265	1SNK140181R0000	246	
AMS CLEANER FLUID	1SNA360155R1700	268	HTP500-ROLL	1SNA235715R2700	265	1SNK140182R0000	248	
AMS CLEANER KIT	1SNA360156R1000	268	HTP500-WB	1SNA235717R2100	265	1SNK140191R0000	246	
AMS INK CARTRIDGES	1SNA360150R2600	268	HTS500	1SNA235702R0300	265	1SNK140192R0000	248	
AMS PEN 0.18	1SNA360103R1400	268	JB10-10	1SNK910310R0000	29	1SNK140201R0000	246	
AMS PEN 0.25	1SNA360100R2500	268	JB10-2	1SNK910302R0000	29	1SNK140202R0000	248	
AMS PEN 0.35	1SNA360101R1200	268	JB10-3	1SNK910303R0000	29	1SNK145011R0000	246	
AMS PEN 0.50	1SNA360104R1500	268	JB10-4	1SNK910304R0000	29	1SNK145012R0000	248	
AMS PEN 0.70	1SNA360105R1600	268	JB10-5	1SNK910305R0000	29	1SNK145021R0000	246	
AMS PEN 1.00	1SNA360106R1700	268	JB12-2	1SNK912302R0000	30	1SNK145022R0000	248	
ANT	1SNA168675R1400	120	JB12-3	1SNK912303R0000	30	1SNK145031R0000	246	
BAM4	1SNK900001R0000	80	JB12-5	1SNK912305R0000	30	1SNK145032R0000	248	
BAZ1	1SNK900002R0000	30	JB16-10	1SNK916310R0000	87	1SNK145041R0000	246	
BAZH1	1SNK900102R0000	56	JB16-2	1SNK916302R0000	87	1SNK145042R0000	248	
BJM131.2	1SNA206053R0700	91	JB16-3	1SNK916303R0000	87	1SNK145051R0000	246	
BJM131.3	1SNA206054R0000	91	JB16-4	1SNK916304R0000	87	1SNK145052R0000	248	
BJM136.2	1SNA206126R2500	92	JB16-5	1SNK916305R0000	87	1SNK145061R0000	246	
BJM136.3	1SNA206223R0600	92	JB22-10	1SNK922310R0000	89	1SNK145062R0000	248	
CDK2.5	1SNK805712R0000	172	JB22-2	1SNK922302R0000	89	1SNK145071R0000	246	
CDK2.5-2P-J	1SNK805740R0000	187	JB22-3	1SNK922303R0000	89	1SNK145072R0000	248	
CDK2.5-2P-J-BL	1SNK805746R0000	187	JB22-5	1SNK922305R0000	89	1SNK145081R0000	246	
CDK2.5-2P-J-BL-E	1SNK805747R0000	187	JB26-10	1SNK926310R0000	90	1SNK145082R0000	248	
CDK2.5-2P-J-E	1SNK805741R0000	187	JB26-2	1SNK926302R0000	90	1SNK145091R0000	246	
CDK2.5-2P-J-PE	1SNK805751R0000	187	JB26-3	1SNK926303R0000	90	1SNK145092R0000	248	
CDK2.5-2P-J-PE-E	1SNK805752R0000	187	JB26-5	1SNK926305R0000	90	1SNK145102R0000	246	
CDK2.5-BL	1SNK805742R0000	175	JB5-10	1SNK905310R0000	21	1SNK146011R0000	246	
CDK2.5-BL-E	1SNK805743R0000	175	JB5-2	1SNK905302R0000	21	1SNK146012R0000	248	
CDK2.5-E	1SNK805713R0000	172	JB5-3	1SNK905303R0000	21	1SNK146021R0000	246	
CDK2.5-J	1SNK805738R0000	186	JB5-4	1SNK905304R0000	21	1SNK146022R0000	248	
CDK2.5-J-BL	1SNK805744R0000	186	JB5-5	1SNK905305R0000	21	1SNK146031R0000	246	
CDK2.5-J-BL-E	1SNK805745R0000	186	JB5-50	1SNK905350R0000	21	1SNK146032R0000	248	
CDK2.5-J-E	1SNK805739R0000	186	JB6-10	1SNK906310R0000	24	1SNK146041R0000	246	
CDK2.5-J-PE	1SNK805748R0000	186	JB6-2	1SNK906302R0000	24	1SNK146042R0000	248	
CDK2.5-J-PE-E	1SNK805749R0000	186	JB6-3	1SNK906303R0000	24	1SNK146051R0000	246	
CDK2.5-PE	1SNK805750R0000	174	JB6-4	1SNK906304R0000	24	1SNK146052R0000	248	
CDK2.5-PE-E	1SNK805753R0000	174	JB6-5	1SNK906305R0000	24	1SNK146061R0000	246	
CDK4	1SNK806712R0000	178	JB6-50	1SNK906350R0000	24	1SNK146062R0000	248	
CDK4-E	1SNK806713R0000	178	JB8-10	1SNK908310R0000	27	1SNK146071R0000	246	
CDS4	1SNK805714R0000	190	JB8-10-R1	1SNK908310R0000	154	1SNK146072R0000	248	
CDS4-E	1SNK805715R0000	190	JB8-2	1SNK908302R0000	27	1SNK146081R0000	246	
CDS4-R1	1SNK806714R0000	192	JB8-2-R1	1SNK908302R0000	154	1SNK146082R0000	248	
CN5	1SNA179371R1600	120	JB8-3	1SNK908303R0000	27	1SNK146091R0000	246	
CO	1SNK900604R0000	155	JB8-3-R1	1SNK908303R0000	154	1SNK146092R0000	248	
COP-ZD	1SNK900636R0000	172	JB8-4	1SNK908304R0000	27	1SNK146101R0000	246	
CPBP1	1SNA399788R1600	91	JB8-4-R1	1SNK908304R0000	154	1SNK146102R0000	248	
CPBP2	1SNA399787R0500	92	JB8-5	1SNK908305R0000	27	1SNK146111R0000	246	
CS	1SNK900101R0000	80	JB85-3	1SNK900603R0000	21	1SNK146112R0000	248	
CS-R1	1SNK900103R0000	80	JB8-5-R1	1SNK908905R0000	154	1SNK146121R0000	246	
CS-R2	1SNK900106R0000	21	KCO	1SNK900624R0000	155	1SNK146122R0000	248	
CS-R3	1SNK900107R0000	30	LH	1SNK900605R0000	199	1SNK146131R0000	246	
DISPOSABLE AMS PEN 0.25	1SNA360120R1000	268	LH-J	1SNK900606R0000	56	1SNK146132R0000	248	
DISPOSABLE AMS PEN 0.35	1SNA360121R0500	268	LH-R1	1SNK900607R0000	199	1SNK146141R0000	246	
DISPOSABLE AMS PEN ED-R 0.18	1SNA360124R1000	268	MC512	1SNK140000R0000	21	1SNK146142R0000	248	
DISPOSABLE AMS PEN ED-R 0.25	1SNA360122R1000	268	MC512PA	1SNK140011R0000	246	1SNK146151R0000	246	
DISPOSABLE AMS PEN ED-R 0.35	1SNA360123R0500	268		1SNK140012R0000	248	1SNK146152R0000	248	
DUST COVER	1SNA360161R1500	265		1SNK140021R0000	246	1SNK146161R0000	246	
ED2.5-22	1SNK805917R0000	173		1SNK140022R0000	248	1SNK146162R0000	248	
EDK2.5-11	1SNK805915R0000	172		1SNK140031R0000	246	1SNK146171R0000	246	
EDK2.5-21	1SNK805914R0000	176		1SNK140032R0000	248	1SNK146172R0000	248	
EDK2.5-22	1SNK805910R0000	177		1SNK140041R0000	246	1SNK146181R0000	246	
EDK2.5-D	1SNK805913R0000	181		1SNK140042R0000	248	1SNK146182R0000	248	
EDS4-22	1SNK805911R0000	190		1SNK140051R0000	246	1SNK146191R0000	246	
EK10	1SNK710910R0000	29		1SNK140052R0000	248	1SNK146192R0000	248	
EK10-3P	1SNK710911R0000	31		1SNK140061R0000	246	1SNK146201R0000	246	
EK2.5	1SNK705910R0000	21		1SNK140062R0000	248	1SNK146202R0000	248	
EK2.5-3P	1SNK705911R0000	22		1SNK140071R0000	246	1SNK146211R0000	246	
EK2.5-4P	1SNK705912R0000	23		1SNK140072R0000	248	1SNK146212R0000	248	
EK2.5-D2	1SNK705960R0000	56		1SNK140081R0000	246	1SNK146221R0000	246	
EK2.5-S-4P	1SNK705913R0000	50		1SNK140082R0000	248	1SNK146222R0000	248	
EK2.5-T3	1SNK705961R0000	60		1SNK140083R0000	246	1SNK146231R0000	246	
EK6-3P	1SNK708911R0000	28		1SNK140084R0000	248	1SNK146232R0000	249	
EPR1	1SNA178431R2200	201		1SNK140091R0000	246	1SNK146241R0000	246	
EPR2	1SNA399726R0700	201		1SNK140092R0000	248	1SNK146242R0000	249	
ES10-ST	1SNK508910R0000	152		1SNK140101R0000	246	1SNK146251R0000	246	
ES4	1SNK505910R0000	80		1SNK140102R0000	248	1SNK146252R0000	249	
ES4-D2	1SNK505960R0000	136		1SNK140111R0000	246	1SNK146261R0000	247	
ES4-D2-SF1	1SNK508911R0000	144		1SNK140112R0000	248	1SNK146262R0000	249	
ES4-SF	1SNK508960R0000	120		1SNK140121R0000	246	1SNK147001R0000	247	



Type	Part Number	Page	Type	Part Number	Page	Type	Part Number	Page
	1SNK147002R0000	249		1SNK150112R0000	254		1SNK156262R0000	255
	1SNK147011R0000	247		1SNK150121R0000	252		1SNK157001R0000	253
	1SNK147012R0000	249		1SNK150122R0000	254		1SNK157002R0000	255
	1SNK147021R0000	247		1SNK150131R0000	252		1SNK157011R0000	253
	1SNK147022R0000	249		1SNK150132R0000	254		1SNK157012R0000	255
	1SNK147031R0000	247		1SNK150141R0000	252		1SNK157021R0000	253
	1SNK147032R0000	249		1SNK150142R0000	254		1SNK157022R0000	255
	1SNK147041R0000	247		1SNK150151R0000	252		1SNK157031R0000	253
	1SNK147042R0000	249		1SNK150152R0000	254		1SNK157032R0000	255
	1SNK147051R0000	247		1SNK150161R0000	252		1SNK157041R0000	253
	1SNK147052R0000	249		1SNK150162R0000	254		1SNK157042R0000	255
	1SNK147061R0000	247		1SNK150171R0000	252		1SNK157051R0000	253
	1SNK147062R0000	249		1SNK150172R0000	254		1SNK157052R0000	255
	1SNK147071R0000	247		1SNK150181R0000	252		1SNK157061R0000	253
	1SNK147072R0000	249		1SNK150182R0000	254		1SNK157062R0000	255
	1SNK147081R0000	247		1SNK150191R0000	252		1SNK157071R0000	253
	1SNK147082R0000	249		1SNK150192R0000	254		1SNK157072R0000	255
	1SNK147091R0000	247		1SNK150201R0000	252		1SNK157081R0000	253
	1SNK147092R0000	249		1SNK150202R0000	254		1SNK157082R0000	255
	1SNK148001R0000	247		1SNK155011R0000	252		1SNK157091R0000	253
	1SNK148002R0000	249		1SNK155012R0000	254		1SNK157092R0000	255
	1SNK148011R0000	247		1SNK155021R0000	252		1SNK158001R0000	253
	1SNK148012R0000	249		1SNK155022R0000	254		1SNK158002R0000	255
	1SNK148021R0000	247		1SNK155031R0000	252		1SNK158011R0000	253
	1SNK148022R0000	249		1SNK155032R0000	254		1SNK158012R0000	255
	1SNK148031R0000	247		1SNK155041R0000	252		1SNK158021R0000	253
	1SNK148032R0000	249		1SNK155042R0000	254		1SNK158022R0000	255
	1SNK148041R0000	247		1SNK155051R0000	252		1SNK158031R0000	253
	1SNK148042R0000	249		1SNK155052R0000	254		1SNK158032R0000	255
	1SNK148051R0000	247		1SNK155061R0000	252		1SNK158041R0000	253
	1SNK148052R0000	249		1SNK155062R0000	254		1SNK158042R0000	255
	1SNK148061R0000	247		1SNK155071R0000	252		1SNK158051R0000	253
	1SNK148062R0000	249		1SNK155072R0000	254		1SNK158052R0000	255
	1SNK148071R0000	247		1SNK155081R0000	252		1SNK158061R0000	253
	1SNK148072R0000	249		1SNK155082R0000	254		1SNK158062R0000	255
	1SNK148091R0000	247		1SNK155091R0000	252		1SNK158071R0000	253
	1SNK148092R0000	249		1SNK155092R0000	254		1SNK158072R0000	255
	1SNK148101R0000	247		1SNK155102R0000	252		1SNK158091R0000	253
	1SNK148102R0000	249		1SNK156011R0000	252		1SNK158092R0000	255
	1SNK148111R0000	247		1SNK156012R0000	254		1SNK158101R0000	253
	1SNK148112R0000	249		1SNK156021R0000	252		1SNK158102R0000	255
	1SNK148121R0000	247		1SNK156022R0000	254		1SNK158111R0000	253
	1SNK148122R0000	249		1SNK156031R0000	252		1SNK158112R0000	255
	1SNK148131R0000	247		1SNK156032R0000	254		1SNK158121R0000	253
	1SNK148132R0000	249		1SNK156041R0000	252		1SNK158122R0000	255
	1SNK148141R0000	247		1SNK156042R0000	254		1SNK158131R0000	253
	1SNK148142R0000	249		1SNK156051R0000	252		1SNK158132R0000	255
	1SNK148151R0000	247		1SNK156052R0000	254		1SNK158141R0000	253
	1SNK148152R0000	249		1SNK156061R0000	252		1SNK158142R0000	255
	1SNK148161R0000	247		1SNK156062R0000	254		1SNK158151R0000	253
	1SNK148162R0000	249		1SNK156071R0000	252		1SNK158152R0000	255
	1SNK148171R0000	247		1SNK156072R0000	254		1SNK158161R0000	253
	1SNK148172R0000	249		1SNK156081R0000	252		1SNK158162R0000	255
	1SNK148181R0000	247		1SNK156082R0000	254		1SNK158171R0000	253
	1SNK148182R0000	249		1SNK156091R0000	252		1SNK158172R0000	255
	1SNK148192R0000	247		1SNK156092R0000	254		1SNK158181R0000	253
	1SNK148202R0000	249		1SNK156101R0000	252		1SNK158182R0000	255
	1SNK148212R0000	247		1SNK156102R0000	254		1SNK158192R0000	253
	1SNK148222R0000	249		1SNK156111R0000	252		1SNK158202R0000	255
	1SNK149001R0000	247		1SNK156112R0000	254		1SNK158212R0000	253
	1SNK149002R0000	249		1SNK156121R0000	252		1SNK158222R0000	255
	1SNK149011R0000	247		1SNK156122R0000	254		1SNK159001R0000	253
	1SNK149012R0000	249		1SNK156131R0000	252		1SNK159002R0000	255
	1SNK149999R0000	21		1SNK156132R0000	254		1SNK159011R0000	253
MC512-YL	1SNK140004R0000	244		1SNK156141R0000	252		1SNK159012R0000	255
MC612	1SNK150000R0000	24		1SNK156142R0000	254	MC612-YL	1SNK159999R0000	24
MC612PA	1SNK150011R0000	252		1SNK156151R0000	252	MC612	1SNK150004R0000	250
	1SNK150012R0000	254		1SNK156152R0000	254	MC812	1SNK160000R0000	30
	1SNK150021R0000	252		1SNK156161R0000	252	MC812PA	1SNK160011R0000	257
	1SNK150022R0000	254		1SNK156162R0000	254		1SNK160012R0000	259
	1SNK150031R0000	252		1SNK156171R0000	252		1SNK160021R0000	257
	1SNK150032R0000	254		1SNK156172R0000	254		1SNK160022R0000	259
	1SNK150041R0000	252		1SNK156181R0000	252		1SNK160031R0000	257
	1SNK150042R0000	254		1SNK156182R0000	254		1SNK160032R0000	259
	1SNK150051R0000	252		1SNK156191R0000	252		1SNK160041R0000	257
	1SNK150052R0000	254		1SNK156192R0000	254		1SNK160042R0000	259
	1SNK150061R0000	252		1SNK156201R0000	252		1SNK160051R0000	257
	1SNK150062R0000	254		1SNK156202R0000	254		1SNK160052R0000	259
	1SNK150071R0000	252		1SNK156211R0000	252		1SNK160061R0000	257
	1SNK150072R0000	254		1SNK156212R0000	254		1SNK160062R0000	259
	1SNK150081R0000	252		1SNK156221R0000	252		1SNK160071R0000	257
	1SNK150082R0000	254		1SNK156222R0000	254		1SNK160072R0000	259
	1SNK150083R0000	252		1SNK156231R0000	252		1SNK160081R0000	257
	1SNK150084R0000	254		1SNK156232R0000	254		1SNK160082R0000	259
	1SNK150091R0000	252		1SNK156241R0000	253		1SNK160083R0000	257
	1SNK150092R0000	254		1SNK156242R0000	254		1SNK160084R0000	259
	1SNK150101R0000	252		1SNK156251R0000	253		1SNK160091R0000	257
	1SNK150102R0000	254		1SNK156252R0000	255		1SNK160092R0000	259
	1SNK150111R0000	252		1SNK156261R0000	253		1SNK160101R0000	257

# Index

## Type classification

Type	Part Number	Page	Type	Part Number	Page	Type	Part Number	Page
	1SNK160102R0000	259		1SNK166252R0000	260	MG2-STB 991005	1SNB991005R0000	266
	1SNK160111R0000	257		1SNK166261R0000	258	MG2-TCT 991562	1SNB991562R0000	266
	1SNK160112R0000	259		1SNK166262R0000	260	MG2-TDMO-01 40340	1SNB040340R0412	261
	1SNK1601121R0000	257		1SNK167001R0000	258	MG2-TDMO-01 40341	1SNB040341R0416	261
	1SNK160122R0000	259		1SNK167002R0000	260	MG2-TDMO-01 40390	1SNB040390R0412	261
	1SNK160131R0000	257		1SNK167011R0000	258	MG2-TDMO-01 40391	1SNB040391R0416	261
	1SNK160132R0000	259		1SNK167012R0000	260	MG2-TDMO-02 40440	1SNB040440R0412	261
	1SNK160141R0000	257		1SNK167021R0000	258	MG2-TDMO-02 40441	1SNB040441R0416	261
	1SNK160142R0000	259		1SNK167022R0000	260	MG2-TDMO-02 40490	1SNB040490R0412	261
	1SNK160151R0000	257		1SNK167031R0000	258	MG2-TDMO-02 40491	1SNB040491R0416	261
	1SNK160152R0000	259		1SNK167032R0000	260	MG2-TDMO-03 40540	1SNB040540R0412	261
	1SNK160161R0000	257		1SNK167041R0000	258	MG2-TDMO-03 40541	1SNB040541R0416	261
	1SNK160162R0000	259		1SNK167042R0000	260	MG2-TDMO-03 40590	1SNB040590R0412	261
	1SNK160171R0000	257		1SNK167051R0000	258	MG2-TDMO-03 40591	1SNB040591R0416	261
	1SNK160172R0000	259		1SNK167052R0000	260	MG2-TGT 991532	1SNB991532R0000	266
	1SNK160181R0000	257		1SNK167061R0000	258	MG2-TLT 991522	1SNB991522R0000	266
	1SNK160182R0000	259		1SNK167062R0000	260	MG2-TMT 991513	1SNB991513R0000	266
	1SNK160191R0000	257		1SNK167071R0000	258	MG2-TST 991552	1SNB991552R0000	266
	1SNK160192R0000	259		1SNK167072R0000	260	MG2-TTB 991512	1SNB991512R0000	266
	1SNK160201R0000	257		1SNK167081R0000	258	MG2-TTD 991563	1SNB991563R0000	266
	1SNK160202R0000	259		1SNK167082R0000	260	MG2-TWC 991502	1SNB991502R0000	266
	1SNK165011R0000	257		1SNK167091R0000	258	MG2-TWT 991542	1SNB991542R0000	266
	1SNK165012R0000	259		1SNK167092R0000	260	MG2-WTB 991004	1SNB991004R0000	266
	1SNK165021R0000	257		1SNK168001R0000	258	MG3 KIT	1SNB419001R0000	244
	1SNK165022R0000	259		1SNK168002R0000	260	MG-CPM 13 41740	1SNB041740R0512	244
	1SNK165031R0000	257		1SNK168011R0000	258	MG-CPM 13 41741	1SNB041741R0612	250
	1SNK165032R0000	259		1SNK168012R0000	260	MG-CPM 13 41790	1SNB041790R0512	21
	1SNK165041R0000	257		1SNK168021R0000	258	MG-CPM 13 41791	1SNB041791R0612	30
	1SNK165042R0000	259		1SNK168022R0000	260	MG-CPMFA 43196	1SNB043196R0012	185
	1SNK165051R0000	257		1SNK168031R0000	258	MG-TAA 49148	1SNB049148R1735	201
	1SNK165052R0000	259		1SNK168032R0000	260	MG-TAA 49198	1SNB049198R1735	201
	1SNK165061R0000	257		1SNK168041R0000	258	MG-TAA 49448	1SNB049448R8530	201
	1SNK165062R0000	259		1SNK168042R0000	260	MG-TAA 49498	1SNB049498R8530	201
	1SNK165071R0000	257		1SNK168051R0000	258	MG-TAPW 49046	1SNB049046R0929	263
	1SNK165072R0000	259		1SNK168052R0000	260	MG-TAPW 49096	1SNB049096R0929	263
	1SNK165081R0000	257		1SNK168061R0000	258	MG-TAR 45194	1SNB045194R1735	201
	1SNK165082R0000	259		1SNK168062R0000	260	MG-TAR 45490	1SNB045490R8530	201
	1SNK165091R0000	257		1SNK168071R0000	258	MG-VYT 46415	1SNB046415R0615	217
	1SNK165092R0000	259		1SNK168072R0000	260	MG-VYT 46915	1SNB046915R0615	217
	1SNK165102R0000	259		1SNK168091R0000	258	PAM43020	1SNA235106R2600	230
	1SNK166011R0000	257		1SNK168092R0000	260	PC5-10	1SNA113544R1200	105
	1SNK166012R0000	259		1SNK168101R0000	258	PC5-2	1SNA113542R1000	105
	1SNK166021R0000	257		1SNK168102R0000	260	PC8-10	1SNA163313R2400	155
	1SNK166022R0000	259		1SNK168111R0000	258	PC81-10	1SNA173523R1100	120
	1SNK166031R0000	257		1SNK168112R0000	260	PC8-2	1SNA116538R1700	226
	1SNK166032R0000	259		1SNK168121R0000	258	PC8-3	1SNA116539R1000	226
	1SNK166041R0000	257		1SNK168122R0000	260	PC8-4	1SNA116540R2500	226
	1SNK166042R0000	259		1SNK168131R0000	258	PC8-R1	1SNA400711R0600	153
	1SNK166051R0000	257		1SNK168132R0000	260	PC8-R2	1SNA400712R0700	155
	1SNK166052R0000	259		1SNK168141R0000	258	PC8-R3	1SNA400713R0000	155
	1SNK166061R0000	257		1SNK168142R0000	260	PC8-R4	1SNA400724R0300	155
	1SNK166062R0000	259		1SNK168151R0000	258	PC8-R5	1SNA400842R0000	155
	1SNK166071R0000	257		1SNK168152R0000	260	PC8-R6	1SNA400843R0000	155
	1SNK166072R0000	259		1SNK168161R0000	258	PC8-R7	1SNA400849R0000	155
	1SNK166081R0000	257		1SNK168162R0000	260	PC8-R8	1SNA400850R0000	155
	1SNK166082R0000	259		1SNK168171R0000	258	PEN HOLDER	1SNA360098R1200	268
	1SNK166091R0000	257		1SNK168172R0000	260	PG5	1SNK900401R0000	52
	1SNK166092R0000	259		1SNK168181R0000	258	PG5-R1	1SNK900402R0000	52
	1SNK166101R0000	257		1SNK168182R0000	260	PG5-R2	1SNK900403R0000	211
	1SNK166102R0000	259		1SNK168192R0000	260	PIB2-TT	1SNA235155R2600	201
	1SNK166111R0000	257		1SNK168202R0000	260	PIB2-TT-YL	1SNA235157R2000	201
	1SNK166112R0000	259		1SNK168212R0000	260	PL10	1SNK900621R0000	85
	1SNK166121R0000	257		1SNK168222R0000	260	PL16	1SNK900622R0000	87
	1SNK166122R0000	259		1SNK169001R0000	258	PL5	1SNK900618R0000	80
	1SNK166131R0000	257		1SNK169002R0000	260	PL6	1SNK900619R0000	81
	1SNK166132R0000	259		1SNK169011R0000	258	PL8	1SNK900620R0000	84
	1SNK166141R0000	257		1SNK169012R0000	260	PR3_G2	1SNA164800R0300	197
	1SNK166142R0000	259		1SNK169999R0000	30	PR3_Z2	1SNA174300R1700	196
	1SNK166151R0000	257	MC812-YL	1SNK160004R0000	256	PR30	1SNA173220R0500	196
	1SNK166152R0000	259	MCLH	1SNK900630R0000	201	PR4	1SNA168500R1200	198
	1SNK166161R0000	257	MCLH-R1	1SNK900631R0000	201	PR5	1SNA168700R2200	198
	1SNK166162R0000	259	MCLH-R1-YL	1SNK900634R0000	201	PR50	1SNA178529R0400	197
	1SNK166171R0000	257	MCLH-YL	1SNK900633R0000	201	PS-3	1SNK900650R0000	213
	1SNK166172R0000	259	MG2-ABM 991012	1SNB991012R0000	266	PT-3	1SNK900625R0000	210
	1SNK166181R0000	257	MG2-CKP 991670	1SNB991670R0000	266	PT-ZD	1SNK900660R0000	185
	1SNK166182R0000	259	MG2-CTB 991006	1SNB991006R0000	266	RC1010	1SNA238000R1600	91
	1SNK166191R0000	257	MG2-ETB 991016	1SNB991016R0000	244	RCPEAD-TT	1SNA235158R0100	201
	1SNK166192R0000	259	MG2-ETR 991600	1SNB991600R0000	266	RCPEAD-TT-YL	1SNA235159R0200	201
	1SNK166201R0000	257	MG2-ETR 991601	1SNB991601R0000	266	RCPEB	1SNA178430R0500	201
	1SNK166202R0000	259	MG2-ETR 991602	1SNB991602R0000	266	RIB-B	1SNA235710R0600	265
	1SNK166211R0000	257	MG2-ETR 991603	1SNB991603R0000	266	RIB-R	1SNA235711R2300	265
	1SNK166212R0000	259	MG2-ETR 991606	1SNB991606R0000	266	RIB-RS	1SNA235718R0200	265
	1SNK166221R0000	257	MG2-LTB 991013	1SNB991013R0000	266	RILS	1SNK900627R0000	219
	1SNK166222R0000	259	MG2-MTB 991008	1SNB991008R0000	266	SC-JB8-2	1SNK900652R0000	152
	1SNK166231R0000	258	MG2-PLT 991002	1SNB991002R0000	266	SC-JB8-3	1SNK900653R0000	156
	1SNK166232R0000	260	MG2-PTD 991007	1SNB991007R0000	266	SC-JB8-3-OR	1SNK900657R0000	231
	1SNK166241R0000	258	MG2-PTM 991010	1SNB991010R0000	261	SC-JB8-4	1SNK900654R0000	156
	1SNK166242R0000	260	MG2-PWC 991000	1SNB991000R0000	266	SC-JB8-4-OR	1SNK900658R0000	231
	1SNK166251R0000	258	MG2-QTB 991011	1SNB991011R0000	266	SC-JB8-5	1SNK900655R0000	231





Type	Part Number	Page	Type	Part Number	Page	Type	Part Number	Page
SERVICE KIT FOR AMS 500	1SNA360162R1600	268	ZK2.5-4P-BK	1SNK705080R0000	23	ZS10-ST-1	1SNK508312R0000	152
SHB	1SNK900602R0000	56	ZK2.5-4P-BL	1SNK705022R0000	23	ZS10-ST-T4	1SNK508311R0000	152
SHBP	1SNK900601R0000	21	ZK2.5-4P-GN	1SNK705075R0000	23	ZS10-WH	1SNK508065R0000	84
SHBS	1SNK900600R0000	80	ZK2.5-4P-OR	1SNK705032R0000	23	ZS10-YL	1SNK508060R0000	84
SPDST1	1SNA360163R1700	268	ZK2.5-4P-RD	1SNK705076R0000	23	ZS150	1SNK531010R0000	91
SPRC 1	1SNA360010R1500	268	ZK2.5-4P-WH	1SNK705079R0000	23	ZS150-BL	1SNK531020R0000	91
SPRC 10	1SNA360020R1700	268	ZK2.5-4P-YL	1SNK705074R0000	23	ZS150-YL	1SNK531060R0000	91
SPRC 11	1SNA360021R0400	268	ZK2.5-BK	1SNK705066R0000	21	ZS16	1SNK510010R0000	85
SPRC 13	1SNA360023R0600	268	ZK2.5-BL	1SNK705020R0000	21	ZS16-BL	1SNK510020R0000	85
SPRC 14	1SNA360024R0700	268	ZK2.5-CH-4P-LR	1SNK705110R0000	65	ZS16-OR	1SNK510030R0000	85
SPRC 15	1SNA360025R0000	268	ZK2.5-CH-4P-RL	1SNK705111R0000	66	ZS16-PE	1SNK510150R0000	85
SPRC 16	1SNA360026R0100	268	ZK2.5-D1	1SNK705211R0000	57	ZS240	1SNK536010R0000	92
SPRC 2	1SNA360011R1500	268	ZK2.5-D1-PE	1SNK705250R0000	56	ZS240-BL	1SNK536020R0000	92
SPRC 21	1SNA360031R0600	264	ZK2.5-D2	1SNK705210R0000	56	ZS240-YL	1SNK536060R0000	92
SPRC 26	1SNA360036R0300	268	ZK2.5-D2-BL	1SNK705220R0000	56	ZS25	1SNK512010R0000	86
SPRC 27	1SNA360037R0400	268	ZK2.5-D2-PE	1SNK705212R0000	58	ZS25-BL	1SNK512020R0000	86
SPRC 28	1SNA360040R2300	268	ZK2.5-D-CH2-DU-RL	1SNK705219R0000	69	ZS25-PE	1SNK512150R0000	86
SPRC 29	1SNA360038R1500	268	ZK2.5-D-CH-DU	1SNK705214R0000	68	ZS25-YL	1SNK512060R0000	86
SPRC 30-3	1SNA360039R1700	245	ZK2.5-D-CH-UD	1SNK705213R0000	67	ZS35	1SNK516010R0000	87
SPRC 4	1SNA360014R0500	268	ZK2.5-GN	1SNK705061R0000	21	ZS35-BL	1SNK516020R0000	87
SPRC 5	1SNA360015R0600	268	ZK2.5-L-L-PE	1SNK705512R0000	62	ZS35-OR	1SNK516030R0000	87
SPRC 6	1SNA360016R0700	268	ZK2.5-L-N-PE	1SNK705513R0000	63	ZS35-PE	1SNK516150R0000	87
SPRC 7	1SNA360017R0000	268	ZK2.5-OR	1SNK705030R0000	21	ZS35-PEN	1SNK516170R0000	101
SPRC 8	1SNA360018R1100	268	ZK2.5-PE	1SNK705150R0000	21	ZS4	1SNK505010R0000	80
SPRC 9	1SNA360019R1200	268	ZK2.5-PE-3P	1SNK705151R0000	22	ZS4-BK	1SNK505066R0000	80
TC5	1SNK900200R0000	21	ZK2.5-PE-4P	1SNK705152R0000	23	ZS4-BL	1SNK505020R0000	80
TC5-R1	1SNK900201R0000	21	ZK2.5-RD	1SNK705062R0000	21	ZS4-BR	1SNK505064R0000	80
TGA8	1SNA168672R1100	120	ZK2.5-S	1SNK705310R0000	49	ZS4-D1	1SNK505211R0000	137
	1SNA168673R1200	120	ZK2.5-S-4P	1SNK705312R0000	50	ZS4-D2	1SNK505210R0000	136
	1SNA168674R1300	120	ZK2.5-S-4P-BL	1SNK705321R0000	50	ZS4-D2-BL	1SNK505220R0000	136
TO3.5-100-INS	1SNK900644R0000	213	ZK2.5-S-4P-OR	1SNK705331R0000	50	ZS4-D2-OR	1SNK505230R0000	136
TO3.5-50	1SNK900640R0000	213	ZK2.5-S-BL	1SNK705320R0000	49	ZS4-D2-S	1SNK505315R0000	142
TO3.5-50-A	1SNK900659R0000	213	ZK2.5-SF	1SNK706410R0000	51	ZS4-D2-SF1	1SNK508425R0000	144
TO4-100	1SNK900641R0000	213	ZK2.5-SF-R1	1SNK706411R0000	55	ZS4-D2-SF1-R1	1SNK508423R0000	145
TO5.5-125	1SNK900642R0000	213	ZK2.5-SF-R3	1SNK706412R0000	55	ZS4-D2-SF1-R3	1SNK508424R0000	145
TO6.5-150	1SNK900643R0000	213	ZK2.5-S-OR	1SNK705330R0000	49	ZS4-D2-S-T2	1SNK505316R0000	143
TP2	1SNK900203R0000	30	ZK2.5-SP	1SNK705311R0000	52	ZS4-D-CH-DU	1SNK505215R0000	149
TP4	1SNK900205R0000	30	ZK2.5-S-4P	1SNK705313R0000	53	ZS4-D-CH-UD	1SNK505214R0000	148
UMH	1SNK900611R0000	30	ZK2.5-S-R1	1SNK706310R0000	51	ZS4-GN	1SNK505061R0000	80
VR-ZD	1SNK900637R0000	185	ZK2.5-T1	1SNK705511R0000	61	ZS4-OR	1SNK505030R0000	80
ZD2.5-11	1SNK805016R0000	172	ZK2.5-T1-PE	1SNK705550R0000	60	ZS4-PE	1SNK505150R0000	80
ZD2.5-22	1SNK805017R0000	173	ZK2.5-T3	1SNK705510R0000	60	ZS4-PE-R2	1SNK506153R0000	131
ZD2.5-22-PE	1SNK805156R0000	174	ZK2.5-WH	1SNK705065R0000	21	ZS4-PR	1SNK505063R0000	80
ZDK2.5-11	1SNK805015R0000	175	ZK2.5-YL	1SNK705060R0000	21	ZS4-R1	1SNK508013R0000	124
ZDK2.5-11-BL	1SNK805025R0000	175	ZK4	1SNK706010R0000	24	ZS4-R2	1SNK506013R0000	130
ZDK2.5-11-PE	1SNK805150R0000	179	ZK4-3P	1SNK706011R0000	25	ZS4-RD	1SNK505062R0000	80
ZDK2.5-21	1SNK805014R0000	176	ZK4-3P-BL	1SNK706021R0000	25	ZS4-S	1SNK506310R0000	105
ZDK2.5-22	1SNK805010R0000	177	ZK4-3P-OR	1SNK706031R0000	25	ZS4-S-BL	1SNK505320R0000	105
ZDK2.5-22-BL	1SNK805020R0000	177	ZK4-4P	1SNK706012R0000	26	ZS4-SF	1SNK506410R0000	126
ZDK2.5-22-PE	1SNK805152R0000	180	ZK4-4P-BL	1SNK706022R0000	26	ZS4-SF1	1SNK506411R0000	120
ZDK2.5-D1	1SNK805214R0000	182	ZK4-4P-OR	1SNK706032R0000	26	ZS4-SF1-OR	1SNK508430R0000	120
ZDK2.5-D1-PE	1SNK805250R0000	184	ZK4-BK	1SNK706066R0000	24	ZS4-SF1-R1	1SNK508412R0000	122
ZDK2.5-D2	1SNK805213R0000	181	ZK4-BL	1SNK706020R0000	24	ZS4-SF1-R2	1SNK508413R0000	123
ZDK2.5-D2-BL	1SNK805223R0000	181	ZK4-OR	1SNK706030R0000	24	ZS4-SF1-R3	1SNK508414R0000	122
ZDK2.5-D2-PE	1SNK805212R0000	183	ZK4-PE	1SNK706150R0000	24	ZS4-SF1-R4	1SNK508415R0000	123
ZDK4-22	1SNK806010R0000	178	ZK4-PE-3P	1SNK706151R0000	25	ZS4-SF1-T2	1SNK508411R0000	121
ZDS4-22	1SNK805013R0000	190	ZK4-PE-4P	1SNK706152R0000	26	ZS4-SF-R1	1SNK506412R0000	128
ZDS4-22-R1	1SNK806013R0000	192	ZK4-RD	1SNK706062R0000	24	ZS4-SF-R2	1SNK506413R0000	129
ZK10	1SNK710010R0000	29	ZK4-YL	1SNK706060R0000	24	ZS4-SF-R3	1SNK506415R0000	128
ZK10-3P	1SNK710011R0000	31	ZK6	1SNK708010R0000	27	ZS4-SF-R4	1SNK506416R0000	129
ZK10-3P-BL	1SNK710021R0000	31	ZK6-3P	1SNK708011R0000	28	ZS4-SF-T2	1SNK506411R0000	127
ZK10-3P-PV	1SNK710064R0000	32	ZK6-3P-BL	1SNK708021R0000	28	ZS4-S-OR	1SNK505330R0000	105
ZK10-3P-PV-BL	1SNK710067R0000	32	ZK6-3P-OR	1SNK708031R0000	28	ZS4-SP	1SNK505313R0000	112
ZK10-BL	1SNK710020R0000	29	ZK6-BK	1SNK708066R0000	27	ZS4-SP-R1	1SNK506313R0000	114
ZK10-OR	1SNK710030R0000	29	ZK6-BL	1SNK708020R0000	27	ZS4-SP-T2	1SNK505314R0000	113
ZK10-PE	1SNK710150R0000	30	ZK6-OR	1SNK708030R0000	27	ZS4-SP-T2-R1	1SNK506314R0000	115
ZK10-PE-3P	1SNK710151R0000	32	ZK6-PE	1SNK708150R0000	27	ZS4-S-R1	1SNK506310R0000	107
ZK10-PV	1SNK710063R0000	30	ZK6-PE-3P	1SNK708151R0000	28	ZS4-S-R1-BL	1SNK506320R0000	107
ZK10-PV-BL	1SNK710065R0000	30	ZK6-RD	1SNK708062R0000	27	ZS4-S-R1-OR	1SNK506330R0000	107
ZK16	1SNK712010R0000	33	ZK6-YL	1SNK708060R0000	27	ZS4-S-R2	1SNK506414R0000	132
ZK16-3P	1SNK712011R0000	35	ZS10	1SNK508010R0000	84	ZS4-S-R3	1SNK508416R0000	125
ZK16-3P-BL	1SNK712021R0000	35	ZS10-BK	1SNK508066R0000	84	ZS4-S-R3-T2	1SNK508419R0000	125
ZK16-3P-PV	1SNK712064R0000	36	ZS10-BL	1SNK508020R0000	84	ZS4-S-T2	1SNK505311R0000	106
ZK16-3P-PV-BL	1SNK712067R0000	36	ZS10-BR	1SNK508064R0000	84	ZS4-S-T2.3	1SNK505312R0000	106
ZK16-BL	1SNK712020R0000	33	ZS10-GN	1SNK508061R0000	84	ZS4-S-T2.3-R1	1SNK506311R0000	108
ZK16-PE	1SNK712150R0000	34	ZS10-OR	1SNK508030R0000	84	ZS4-S-T2-BL	1SNK505321R0000	106
ZK16-PE-3P	1SNK712151R0000	36	ZS10-PE	1SNK508150R0000	84	ZS4-S-T2-OR	1SNK505331R0000	106
ZK16-PV	1SNK712063R0000	34	ZS10-PE-R1	1SNK508151R0000	153	ZS4-S-T2-R1	1SNK505311R0000	108
ZK16-PV-BL	1SNK712065R0000	34	ZS10-PR	1SNK508063R0000	84	ZS4-S-T2-R1-BL	1SNK506321R0000	108
ZK2.5	1SNK705010R0000	21	ZS10-R1	1SNK508011R0000	152	ZS4-S-T2-R1-OR	1SNK506331R0000	108
ZK2.5-3P	1SNK705011R0000	22	ZS10-RD	1SNK508062R0000	84	ZS4-T3	1SNK505212R0000	146
ZK2.5-3P-BK	1SNK705073R0000	22	ZS10-S	1SNK508315R0000	111	ZS4-T3-R1	1SNK506213R0000	147
ZK2.5-3P-BL	1SNK705021R0000	22	ZS10-S-BL	1SNK508320R0000	111	ZS4-WH	1SNK505065R0000	80
ZK2.5-3P-GN	1SNK705068R0000	22	ZS10-SF	1SNK508418R0000	133	ZS4-YL	1SNK505060R0000	80
ZK2.5-3P-OR	1SNK705031R0000	22	ZS10-SF-R1	1SNK508421R0000	134	ZS50	1SNK516011R0000	88
ZK2.5-3P-RD	1SNK705069R0000	22	ZS10-SF-R3	1SNK508422R0000	134	ZS50-BK	1SNK516064R0000	88
ZK2.5-3P-WH	1SNK705072R0000	22	ZS10-SP	1SNK508316R0000	116	ZS50-BL	1SNK516021R0000	88
ZK2.5-3P-YL	1SNK705067R0000	22	ZS10-S-R2	1SNK508417R0000	135	ZS50-PE	1SNK516151R0000	88
ZK2.5-4P	1SNK705012R0000	23	ZS10-ST	1SNK508310R0000	154	ZS50-RD	1SNK516063R0000	88



# Index

## Type classification

Type	Part Number	Page	Type	Part Number	Page	Type	Part Number	Page
ZS50-YL	1SNK516060R0000	88						
ZS6	1SNK506010R0000	81						
ZS6-3S	1SNK506011R0000	82						
ZS6-3S-BL	1SNK506021R0000	82						
ZS6-3S-PE	1SNK506151R0000	82						
ZS6-3S-YL	1SNK506067R0000	82						
ZS6-4S	1SNK506012R0000	83						
ZS6-4S-BL	1SNK506022R0000	83						
ZS6-4S-PE	1SNK506152R0000	83						
ZS6-4S-YL	1SNK506068R0000	83						
ZS6-BK	1SNK506066R0000	81						
ZS6-BL	1SNK506020R0000	81						
ZS6-BR	1SNK506064R0000	81						
ZS6-D1	1SNK506211R0000	139						
ZS6-D1-PE	1SNK506250R0000	138						
ZS6-D1-RD	1SNK506214R0000	139						
ZS6-D2	1SNK506210R0000	138						
ZS6-D2-BK	1SNK506266R0000	138						
ZS6-D2-BL	1SNK506220R0000	138						
ZS6-D2-OR	1SNK506230R0000	138						
ZS6-D2-PE	1SNK506212R0000	140						
ZS6-D2-RD	1SNK506262R0000	138						
ZS6-D2-WH	1SNK506265R0000	138						
ZS6-D2-YL	1SNK506260R0000	138						
ZS6-GN	1SNK506061R0000	81						
ZS6-OR	1SNK506030R0000	81						
ZS6-PE	1SNK506150R0000	81						
ZS6-PR	1SNK506063R0000	81						
ZS6-RD	1SNK506062R0000	81						
ZS6-S	1SNK506315R0000	109						
ZS6-S-4S-T2	1SNK506316R0000	110						
ZS6-S-BL	1SNK506322R0000	109						
ZS6-WH	1SNK506065R0000	81						
ZS6-YL	1SNK506060R0000	81						
ZS70	1SNK522010R0000	89						
ZS70-BL	1SNK522020R0000	89						
ZS70-PE	1SNK522150R0000	89						
ZS70-YL	1SNK522060R0000	89						
ZS95	1SNK526010R0000	90						
ZS95-BL	1SNK526020R0000	90						
ZS95-PE	1SNK526150R0000	90						
ZS95-YL	1SNK526060R0000	90						

## Notes

---

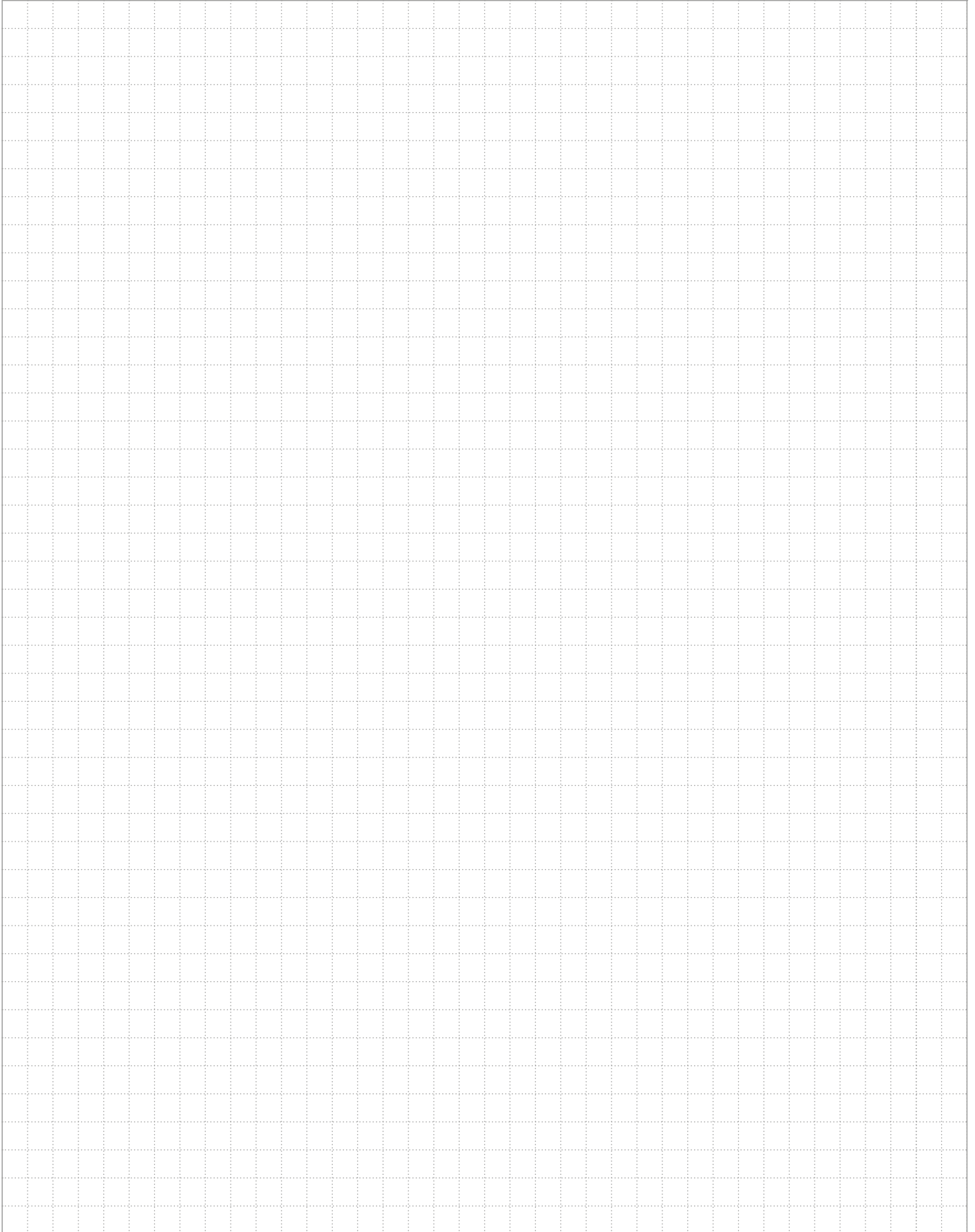



## LET'S CONNECT

We make it easy to connect with our experts and are ready to provide all the support you need. For additional information or product assistance, please contact your field representative or our customer service department. Additional information is also available on the website <http://www.te.com/entrelec>.

## TECHNICAL SUPPORT

[te.com/support-center](http://te.com/support-center)

### Asia:

+86 400-820-6015

### Europe, Middle East, & Africa:

+49 6251-133-0

### North America:

+1-888-441-9982

## te.com

ENTRELEC, TE Connectivity, TE Connectivity (logo) and Every Connection Counts are trademarks. All other logos, products and/or company names referred to herein might be trademarks of their respective owners.

All other logos, products and/or company names referred to herein might be trademarks of their respective owners.

The information given herein, including drawings, illustrations and schematics which are intended for illustration purposes only, is believed to be reliable. However, TE Connectivity makes no warranties as to its accuracy or completeness and disclaims any liability in connection with its use. TE Connectivity's obligations shall only be as set forth in TE Connectivity's Standard Terms and Conditions of Sale for this product and in no case will TE Connectivity be liable for any incidental, indirect or consequential damages arising out of the sale, resale, use or misuse of the product. Users of TE Connectivity products should make their own evaluation to determine the suitability of each such product for the specific application.

© 2020 TE Connectivity Ltd. family of companies All Rights Reserved.

1-1773957-4\_EN 01/20 - Printed in France (Z - Maqprint)

### TE Connectivity

3, rue Jean Perrin  
69687 Chassieu cedex  
France

Tel: +33 481923100

[www.te.com/](http://www.te.com/)