

AXICOM IM RELAY

SIGNAL RELAYS

INTRODUCTION

TE Connectivity (TE)'s Axicom IM signal relays, as part of our smallest types of electromechanical relays, offer a wide and deep range of variations suitable for many applications.

The IM series are equipped with 2 changeover contacts in both monostable or bistable versions, available in multiple coil solutions, performance types and pin layouts.

FEATURES

- Slim line 10x6 mm, low profile 5.65 mm and min. board-space 60mm².
- Switching current 2/5 A, switching power 60 W/62.5 VA and switching voltage 220 VDC/250 VAC.
- Low coil power consumption, 140 mW standard, 100 mW for high sensitive version, 50 mW for ultra high sensitive version and 100 mW for bistable version.
- High dielectric and surge capability up to 2500 V_{rms} between open contacts and 2500 V_{rms} between coil and contacts.
- High mechanical shock resistance up to 50 g functional.

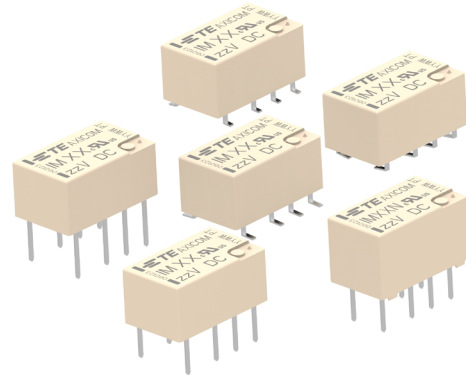

APPLICATIONS

- Telecommunication
- Access and transmission equipment
- Optical network terminals
- Modems
- Office and business equipment
- Consumer electronics
- Measurement and test equipment
- Industrial control
- Medical equipment
- HVAC

APPROVALS

- UL 61810-1 (former UL 508) File No. E214025



Technical data of approved types on request

Buyer entirely assumes the risk and all liability relating to (a) assessing the suitability for Buyer's intended use of the Products and of any system design or drawing and (b) determining the compliance of Buyer's use of the Products with applicable laws, regulations, codes and standards. For more info on the exclusive and applicable warranty, please refer to TE standard warranty terms.

CONTACT DATA

Performance type	Standard, C (Standard and high dielectric version)	D, I (High current version)	P (High contact stability version)
Contact arrangement	2 form C, 2 CO		
Max. switching voltage	220 VDC, 250 VAC	220 VDC, 250 VAC	220 VDC, 250 VAC
Rated current	2 A	5 A ¹⁾	2 A
Limiting continuous current	2 A	5 A ¹⁾	2 A
Switching power	60 W, 62.5 VA		
Contact material	PdRu +Au covered	AgNi +Au covered	PdRu +Au covered
Contact style	Twin contacts	Twin contacts I: single contacts	Twin contacts
Minimum switching voltage	100 μ V		
Initial contact resistance	<50 m Ω at 10 mA/30 mV I: < 100 m Ω		
Thermoelectric potential	<10 μ V		
Operate time	typ. 1 ms, max. 3 ms		
Release time			
Without diode in parallel	typ. 1 ms, max. 3 ms		
With diode in parallel	typ. 3 ms, max. 5 ms		
Bounce time max.	typ. 1 ms, max. 5 ms		
Electrical endurance			
at contact application 0 (≤ 30 mV/ ≤ 10 mA)	min. 2.5x10 ⁶ operations		
Cable load open end	min. 2.0x10 ⁶ operations		
Resistive, 125VDC / 0.24A - 30W	min. 5x10 ⁵ operations		
Resistive, 220 VDC / 0.27A - 60W	min. 1x10 ⁵ operations		
Resistive, 250VAC / 0.25A - 62.5VA	min. 1x10 ⁵ operations		
Resistive, 30VDC / 1A - 30W	min. 5x10 ⁵ operations		
Resistive, 30VDC / 2A - 60W	min. 1x10 ⁵ operations		

Performance type	Standard, C (Standard and high dielectric version)	D, I (High current version)	P (High contact stability version)
UL contact rating	30 VDC, 2 A, 60 W, NO only 110 VDC, 0.3 A, 33 W 220 VDC, 0.27 A, 60 W 125 VAC, 0.5 A, 62.5 VA 250 VAC, 0.25 A, 62.5 VA 30 VAC, 2 A, 62.5 VA, NO only (IMxxI, IMxxD)		
Mechanical endurance	min. 1x10 ⁸ operations		

MAX. DC LOAD BREAKING CAPACITY

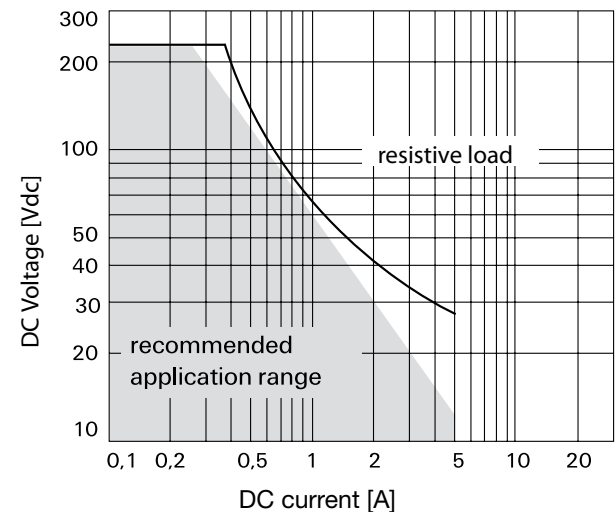

1) for 5A applications please contact TE

COIL DATA

Magnetic system	Monostable, bistable
Coil voltage range	1.5 VDC to 24 VDC

Coil code	Rated voltage VDC	Operate voltage VDC	Release voltage VDC	Coil resistance $\Omega \pm 10\%$	Rated coil power mW
-----------	-------------------	---------------------	---------------------	-----------------------------------	---------------------

Coil versions, standard version, monostable, 1 coil

00	1.5	1.13	0.15	16	140
08	2.4	1.80	0.24	41	140
01	3	2.25	0.30	64	140
02	4.5	3.38	0.45	145	140
03	5	3.75	0.50	178	140
04	6	4.50	0.60	257	140
05	9	6.75	0.90	579	140
06	12	9.00	1.20	1029	140
07	24	18.00	2.40	2880	200

Coil versions, sensitive version, monostable, 1 coil

11	3	2.40	0.30	91	100
12	4.5	3.60	0.45	194	100
13	5	4.00	0.50	234	100
16	12	9.60	1.20	1315	110
17	24	19.20	2.40	4120	140

Coil versions, ultra high sensitive version, monostable, 1 coil

21	3	3.00	0.30	180	50
22	4.5	4.50	0.45	405	50
23	5	5.00	0.50	500	50
26	12	12.00	1.20	2880	50

All figures are given for coil without pre-energization, at ambient temperature +23 °C

Coil code	Rated voltage VDC	Set voltage VDC	Reset voltage VDC	Coil resistance $\Omega \pm 10\%$	Rated coil power mW
-----------	-------------------	-----------------	-------------------	-----------------------------------	---------------------

Coil versions, standard version, bistable 1 coil

40	1.5	1.13	-1.13	23	100
48	2.4	1.80	-1.80	58	100
41	3	2.25	-2.25	90	100
42	4.5	3.38	-3.38	203	100
43	5	3.75	-3.75	250	100
44	6	4.50	-4.50	360	100
45	9	6.75	-6.75	810	100
46	12	9.00	-9.00	1440	100
47	24	18.00	-18.00	2880	200

COIL OPERATING RANGE, STANDARD VERSION, MONOSTABLE, 1 COIL

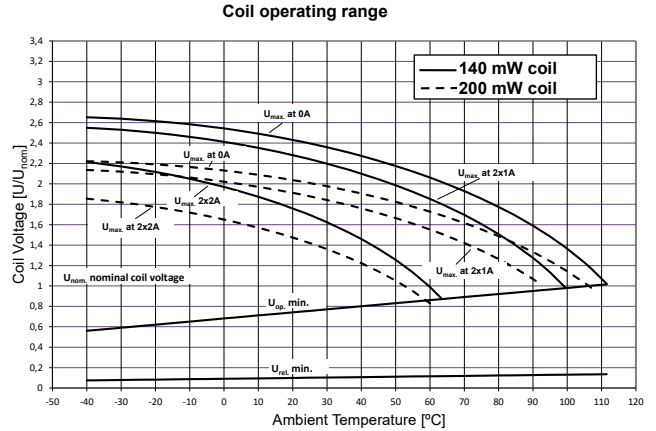

COIL OPERATING RANGE, SENSITIVE AND ULTRA HIGH SENSITIVE VERSION, MONOSTABLE, 1 COIL

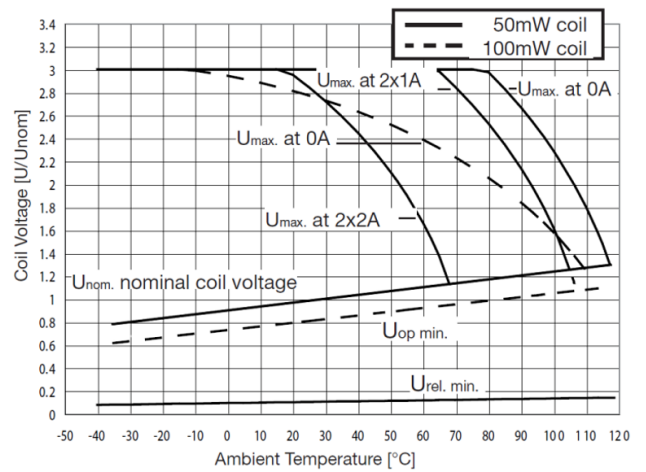

COIL OPERATING RANGE, STANDARD VERSION, BISTABLE, 1 COIL

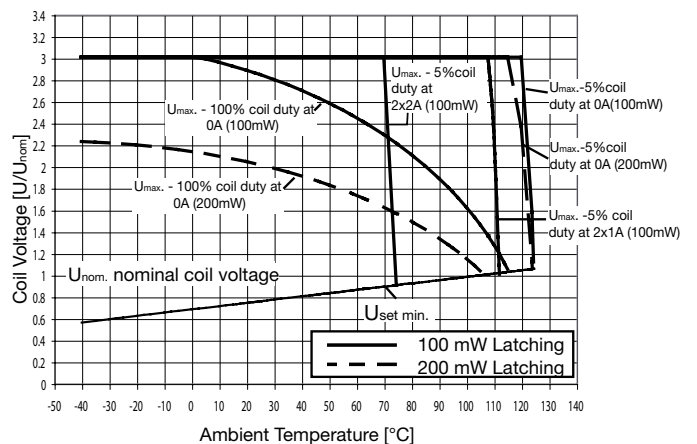

INSULATION DATA

Performance type	Standard (Standard, sensitive, ultra high sensitive version)	C ²⁾ (High dielectric version)	D, P, I (High current, high contact stability version)
Initial dielectric strength			
between open contacts	750 Vrms	1500 Vrms	750 Vrms
between contact and coil	1800 Vrms	1800 Vrms	1500 Vrms
between adjacent contacts	1000 Vrms	1800 Vrms	750 Vrms
Initial surge withstand voltage			
between open contacts	1500 V	2500 V	1000 V
between contact and coil	2500 V	2500 V	2000 V
between adjacent contacts	1500 V	2500 V	1000 V
Initial insulation resistance			
between insulated elements	>10 ⁹ Ω	>10 ⁹ Ω	>10 ⁹ Ω
Capacitance			
between open contacts	max. 1 pF		
between contact and coil	max. 2 pF		
between adjacent contacts	max. 2 pF		

2) this relay contains SF6 (Sulfur hexafluoride, CAS number: 2551-62-4) for dielectric strength enhancement, SF6 is hermetically sealed in relay without leaks to air during normal application as recommended per the applicable product specification. It is clarified that the usage of SF6 in mini signal relay is not prohibited by related regulations. Please contact TE local sales or field engineer for further information and detailed material declaration. To ensure the dielectric performance after soldering processes / assembly customer is advised to perform a dielectric test.

RF DATA

Isolation at 100MHz/900MHz	37.0 dB/18.8 dB
Insertion loss at 100MHz/900MHz	0.03 dB/0.33 dB
Voltage standing wave ratio (VSWR) at 100MHz/900MHz	1.06/1.49

OTHER DATA

Material compliance	EU RoHS/ELV, China RoHS, REACH, Halogen content refer to the Product Compliance Support Center at www.te.com/customer-support/rohssupportcenter
Ambient temperature	-40 °C to +85 °C
Thermal resistance	<150 K/W
Category of environmental protection IEC 61810	RT V - hermetically sealed
Vibration resistance (functional)	20 g, 10 to 500 Hz
Shock resistance (functional), half sinus 11ms	50 g
Shock resistance (destructive), half sinus 0.5ms	500 g
Mounting position	any
Weight	max. 0.75 g
Resistance to soldering heat SMT IEC 60068-2-58	Moisture sensitive level, JEDEC J-STD-020F MSL3 related only to SMT relays packed in original dry-packs. Calculated shelf life in sealed bag: 36 months at <40°C and <90% relative humidity (RH). Floor life (out of the bag) at assembly site is 168 Hours at ≤ 30°C/60% RH.
Ultrasonic cleaning	not recommended
Packaging/unit	
THT version	tube/50pcs., box/1000 pcs.
SMT version	reel/1000 pcs., box/1000 or 5000 pcs.
Avoid using the relays under strong magnetic fields, as electrical parameters will be affected, such as operate/set voltage and release/reset voltage.	

**MONOSTABLE VERSION
REST CONDITION**

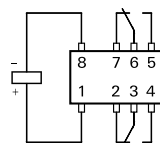

**BISTABLE VERSION, 1 COIL
RESET CONDITION**

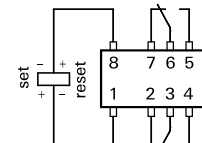

Contacts are shown in reset condition. Contact position might change during transportation and must be reset before use.

AXICOM IM RELAY

SIGNAL RELAYS

DIMENSIONS (UNIT: mm)

THT Standard version

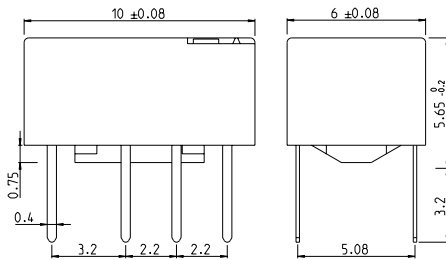

THT Short version

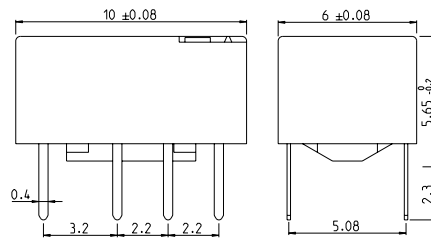

THT Narrow version

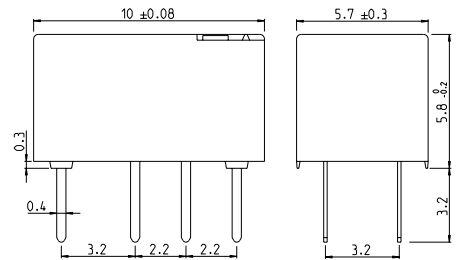

SMT Gull wings version

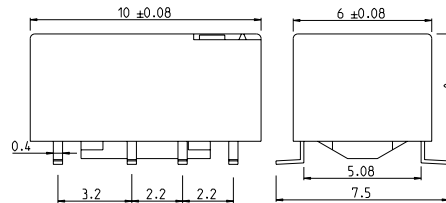

Coplanarity ≤ 0.1

SMT Short Gull wings version

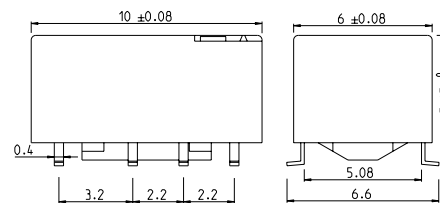

Coplanarity ≤ 0.1

SMT J-legs version

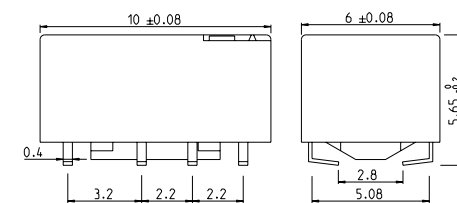

Coplanarity ≤ 0.1

PCB LAYOUT

Top view on component side of PCB

THT Standard and Short version

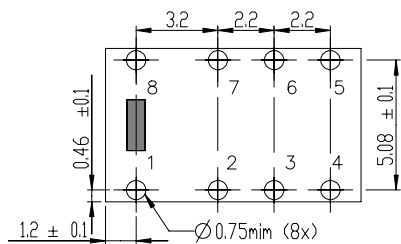

THT Narrow version

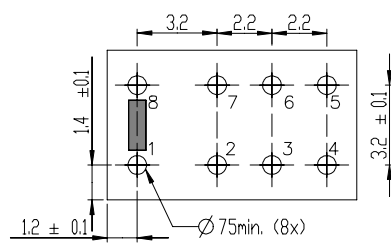

SMT Gull wings version

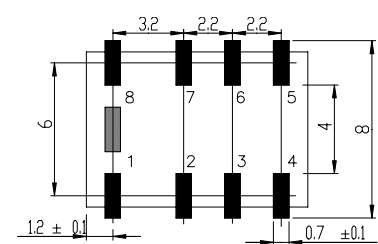

SMT Short Gull wings version

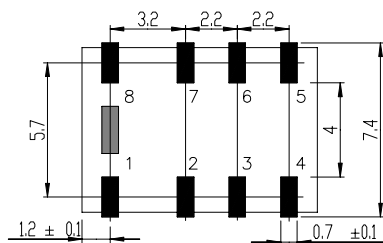

SMT J-legs version

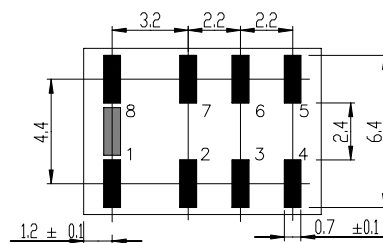

Note:

Customer needs to apply enough solder paste volume / thickness / solder material content to ensure a stable solder joint

PROCESSING

Recommended soldering conditions

Recommended reflow soldering profile IEC 61760-1

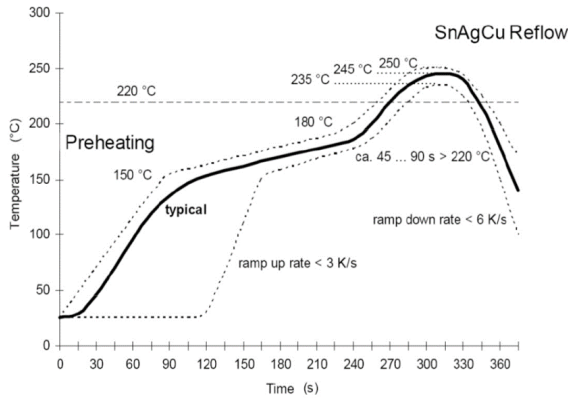

Copyright © 2015 IEC Geneva, Switzerland.

Recommended vapor phase soldering profile

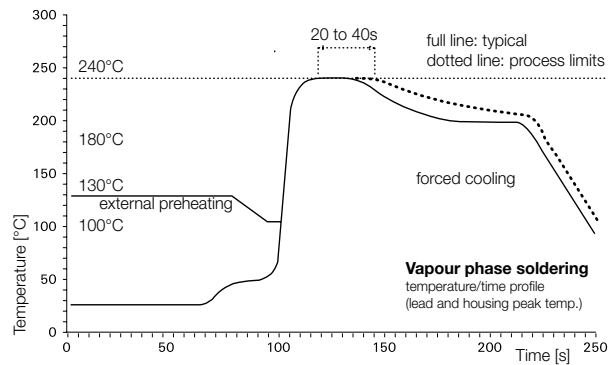

PACKING

Tube for THT version

50 relays per tube, 1000 relays per box

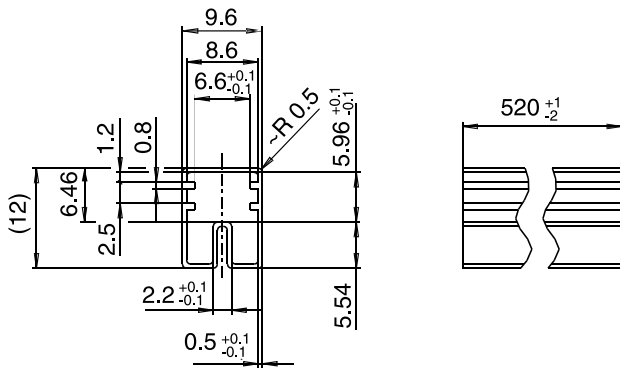

Tape and reel for SMT version

1000 relays per reel, 1000 or 5000 relays per box

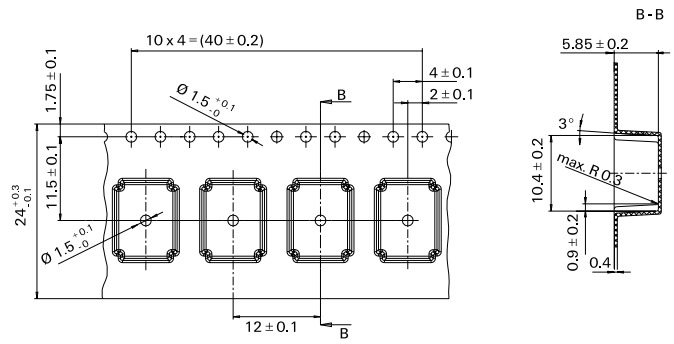

Reel dimensions

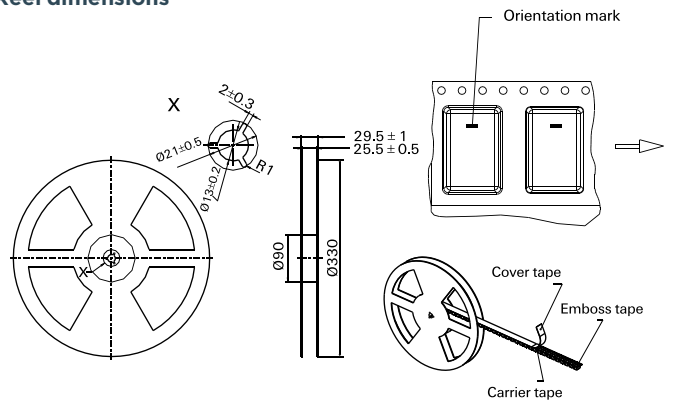

Note:

The author thanks the International Electrotechnical Commission (IEC) for permission to reproduce information from its International Standards. All such extracts are copyright of IEC, Geneva, Switzerland. All rights reserved. Further information on the IEC is available from www.iec.ch. IEC has no responsibility for the placement and context in which the extracts and contents are reproduced by the author, nor is IEC in any way responsible for the other content or accuracy therein."

PRODUCT CODE STRUCTURE

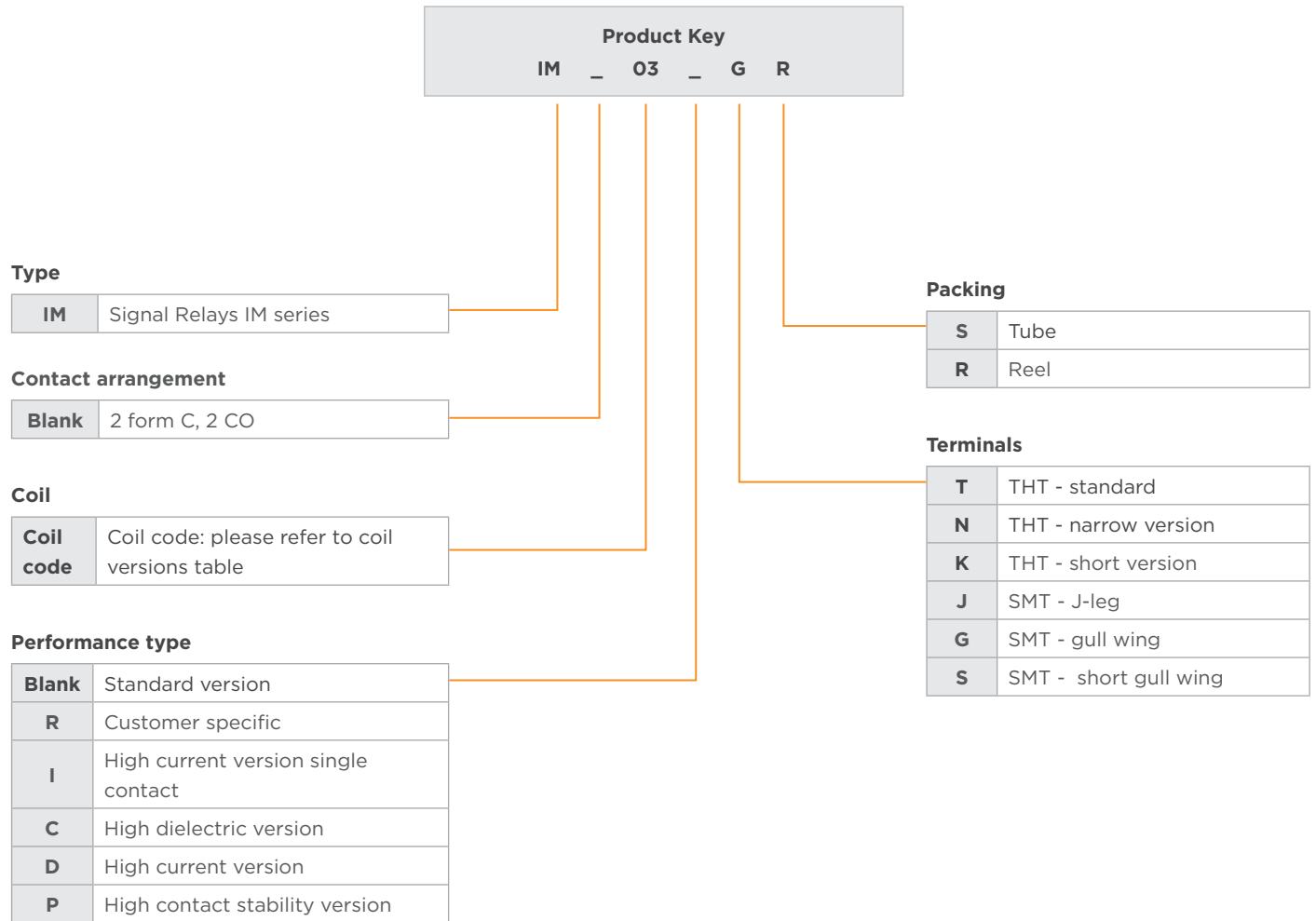

PRODUCT SELECTION INFORMATION

Product code	Arrangement	Perf. type	Coil	Coil type	Coil	Terminals	Part number			
IM00GR	2 form C, 2 CO contacts	Standard	1.5VDC	Monostable	Standard	SMT gull wing	3-1462037-7			
IM00JR						SMT J-leg	3-1462037-9			
IM00NS						THT narrow	1-1462038-0			
IM01GR						SMT gull wing	1462037-1			
IM01SR						SMT short gull wing	2-1462040-3			
IM01JR						SMT J-leg	4-1462037-0			
IM01NS			THT narrow			1-1462038-1				
IM01TS			THT standard			1462037-4				
IM02GR			4.5VDC			Standard	Monostable	Standard	SMT gull wing	1462037-9
IM02SR									SMT short gull wing	2-1462040-4
IM02JR									SMT J-leg	1-1462037-1
IM02NS									THT narrow	1-1462038-2

AXICOM IM RELAY

SIGNAL RELAYS

Product code	Arrangement	Perf. type	Coil	Coil type	Coil	Terminals	Part number	
IM03GR	2 form C, 2 CO contacts	Standard	5VDC	Monostable	Standard	SMT gull wing	1-1462037-4	
IM03SR						SMT short gull wing	2-1462040-5	
IM03JR						SMT J-leg	1-1462037-6	
IM03NS						THT narrow	1-1462038-3	
IM03TS						THT standard	1-1462037-8	
IM04GR						6VDC	SMT gull wing	4-1462037-2
IM04JR			SMT J-leg				4-1462037-4	
IM04NS			THT narrow				1-1462038-4	
IM05GR			9VDC			SMT gull wing	3-1462037-4	
IM05SR						SMT short gull wing	2-1462040-6	
IM05JR						SMT J-leg	4-1462037-5	
IM05NS						THT narrow	1-1462038-5	
IM05TS						THT standard	2-1462037-2	
IM06GR						12VDC	SMT gull wing	2-1462037-3
IM06SR			SMT short gull wing				2-1462040-7	
IM06JR			SMT J-leg				4-1462037-6	
IM06NS			THT narrow			1-1462038-6		
IM07GR			24VDC			SMT gull wing	4-1462037-7	
IM07SR						SMT short gull wing	2-1462040-8	
IM07JR						SMT J-leg	4-1462037-8	
IM07NS						THT narrow	1-1462038-7	
IM08GR						2.4VDC	SMT gull wing	6-1462039-3
IM11GR						3VDC		9-1462038-5
IM12GR			4.5VDC			1462039-3		
IM13GR			5VDC			1462039-4		
IM16GR			12VDC			1462039-5		
IM17GR			24VDC			1462039-6		
IM17TS			24VDC			THT standard	4-1462039-6	
IM21GR						3VDC	SMT gull wing	2-1462039-6
IM21TS							THT standard	1-1462039-5
IM22GR						4.5VDC	SMT gull wing	2-1462039-7
IM22TS							THT standard	2-1462039-8
IM23GR	5VDC	SMT gull wing		2-1462039-9				
IM23TS		THT standard		3-1462039-0				
IM23KS		THT short		6-1462039-7				
IM26GR	12VDC	SMT gull wing		3-1462039-1				
IM26TS		THT standard		3-1462039-2				
					High sens.			
					Ultra high sensitive			

AXICOM IM RELAY

SIGNAL RELAYS

Product code	Arrangement	Perf. type	Coil	Coil type	Coil	Terminals	Part number
³⁾ IM40GR	2 form C, 2 CO contacts	Standard	1.5VDC	Bistable	Standard	SMT gull wing	5-1462037-1
³⁾ IM40SR						SMT short gull wing	2-1462040-9
³⁾ IM40JR						SMT J-leg	5-1462037-2
³⁾ IM40NS						THT narrow	1-1462038-8
³⁾ IM40TS						THT standard	5-1462037-0
³⁾ IM41GR						SMT gull wing	5-1462037-4
³⁾ IM41SR			SMT short gull wing			3-1462040-0	
³⁾ IM41JR			SMT J-leg SMT			5-1462037-5	
³⁾ IM41NS			THT narrow			1-1462038-9	
³⁾ IM41TS			THT standard			5-1462037-3	
³⁾ IM42GR			SMT gull wing			3-1462037-1	
³⁾ IM42SR			SMT short gull wing			3-1462040-1	
³⁾ IM42JR			SMT J-leg			5-1462037-7	
³⁾ IM42NS			THT narrow			2-1462038-0	
³⁾ IM42TS			THT standard			5-1462037-6	
³⁾ IM43GR			SMT gull wing			5-1462037-9	
³⁾ IM43SR			SMT short gull wing			3-1462040-2	
³⁾ IM43JR			SMT J-leg			6-1462037-0	
³⁾ IM43NS			THT narrow			2-1462038-1	
³⁾ IM43TS			THT standard			5-1462037-8	
³⁾ IM44GR			SMT gull wing			6-1462037-2	
³⁾ IM44SR			SMT short gull wing			3-1462040-3	
³⁾ IM44JR			SMT J-leg			6-1462037-3	
³⁾ IM44NS			THT narrow			2-1462038-2	
³⁾ IM44TS			THT standard			6-1462037-1	
³⁾ IM45GR			SMT gull wing			6-1462037-4	
³⁾ IM45SR			SMT short gull wing			3-1462040-4	
³⁾ IM45JR			SMT J-leg			6-1462037-5	
³⁾ IM45NS			THT narrow			2-1462038-3	
³⁾ IM46GR			SMT gull wing			6-1462037-7	
IM46SR			SMT short gull wing			3-1462040-5	
³⁾ IM46JR			SMT J-leg			6-1462037-8	
³⁾ IM46NS			THT narrow			2-1462038-4	
³⁾ IM46TS	THT standard	6-1462037-6					
IM47GR	SMT gull wing	7-1462037-0					
IM47JR	SMT J-leg	7-1462037-1					
IM47NS	THT narrow	2-1462038-5					
IM47TS	THT standard	6-1462037-9					
³⁾ IM48GR	SMT gull wing	1462039-8					
³⁾ IM48SR	SMT short gull wing	3-1462040-6					
			12VDC				
			24VDC				
			2.4VDC				

³⁾ Type VDE certified, for more information contact TE

AXICOM IM RELAY

SIGNAL RELAYS

Product code	Arrangement	Perf. type	Coil	Coil type	Coil	Terminals	Part number		
IM01CGR	2 form C, 2 CO contacts	High dielectric	3VDC	Monostable	Standard	SMT gull wing	1462038-4		
IM01CTS						THT standard	9-1462038-6		
IM02CGR			4.5VDC			SMT gull wing	1462038-1		
IM03CGR							1462038-2		
IM03CJR			5VDC			SMT J-leg	4-1462039-8		
IM03CTS						THT standard	4-1462039-7		
IM05CGR			9VDC			SMT gull wing	1462038-3		
IM06CGR			12VDC			SMT J-leg	3-1462039-4		
IM06CJR						THT standard	4-1462037-9		
IM06CTS									
IM07CGR			24VDC			SMT gull wing	1462039-2		
IM07CTS						THT standard	1462039-1		
IM17CGR							High sens.	1462039-7	
³⁾ IM41CGR			3VDC			Bistable	Standard	SMT gull wing	4-1462039-2
³⁾ IM42CGR			4.5VDC						4-1462039-1
³⁾ IM43CGR			5VDC						9-1462038-7
³⁾ IM48CGR	2.4VDC	9-1462039-0							
IM02DGR		High current	4.5VDC	Monostable	Standard	SMT gull wing	9-1462038-8		
IM02IJR						SMT J-leg	1462047-8		
IM02IGR						SMT gull wing	1462047-9		
IM03DGR			5VDC			SMT gull wing	9-1462038-9		
IM03DJR						SMT J-leg	3-1462039-3		
IM05DGR			9VDC			SMT gull wing	1-1462039-7		
IM06DGR			12VDC			SMT gull wing	1-1462039-8		
IM06DJR						SMT J-leg	7-1462039-0		
IM06DTS						THT standard	3-1462039-8		
IM07DGR			24VDC			SMT gull wing	3-1462039-7		
IM07DJR						SMT J-leg	7-1462039-4		
IM07DTS						THT standard	7-1462039-2		
IM22DTS			4.5VDC				U.h.sens.	7-1462039-6	
IM41DGR			3VDC			Bistable	Standard	SMT gull wing	6-1462039-8
IM42DGR			4.5VDC						1-1462039-9
IM42DNS								THT narrow	1-1462039-6
IM46DNS	12VDC	1-1462039-2							
IM47DJR	24VDC	SMT J-leg	7-1462039-5						
IM48DGR	2.4VDC	SMT gull wing	1462039-9						
IM49DGR	2VDC		2-1462039-2						
IM40IGR	1.5VDC		1462047-7						
IM48IGR	2.4VDC		1462047-1						
IM49IGR	2VDC		1462047-4						

3) Type VDE certified, for more information contact TE

Product code	Arrangement	Perf. type	Coil	Coil type	Coil	Terminals	Part number
IM02PGR		High contact stability	4.5VDC	Monostable	Standard		5-1462039-4
IM02PNS						THT narrow	5-1462039-8
IM03PGR			5VDC			SMT gull wing	5-1462039-5
IM03PJR						SMT J-leg	6-1462039-6
IM03PNS			THT narrow			5-1462039-9	
IM06PGR			12VDC			SMT gull wing	5-1462039-6
IM06PNS				THT narrow		6-1462039-0	
IM42PGR			4.5VDC	Bistable		SMT gull wing	5-1462039-7
IM42PNS						THT narrow	7-1462039-8
IM43PGR						SMT gull wing	7-1462039-3
IM46PNS						THT narrow	6-1462039-1

3) Type VDE certified, for more information contact TE

Note:

This list represents the most common types and does not show all variants covered by this datasheet. Other types on request.

Notes:

- Datasheets and product specification according to IEC 61810-1 and to be used only together with the 'Definitions' section.
- Datasheets and product data is subject to the terms of the disclaimer and all chapters of the 'Definitions' section, available at <http://relays.te.com/definitions>.
- Datasheets, product data, 'Definitions' section, application notes and all specifications are subject to change.

te.com

©2024 TE Connectivity Ltd. Family of Companies. All Rights Reserved.

AXICOM, TE Connectivity, TE connectivity (logo) and Every Connection Counts are trademarks. All other logos, products and/or company names referred to herein might be trademarks of their respective owners.

While TE has made every reasonable effort to ensure the accuracy of the information in this document, TE does not guarantee that it is error-free, nor does TE make any other representation, warranty or guarantee that the information is accurate, correct, reliable or current. TE reserves the right to make any changes to the information contained herein without prior notice. TE Connectivity assumes only those obligations set forth in the terms and conditions for this product and shall in no event be liable for any incidental, indirect, or consequential damages arising out of the sale, resale, use, or misapplication of the product. TE expressly disclaims any implied warranties with respect to the information contained herein, including, but not limited to, implied warranties of merchantability or fitness for a particular purpose. Dimensions, specifications and/or information contained herein are for reference purposes only and are subject to change without notice. Consult TE for the latest dimensions, specifications and/or information. Users of TE Connectivity products must make their own assessment as to whether the respective product is suitable for the respective desired application.

08/24 ED