

AUTOMOTIVE GRADE MULTILAYER CHIP BEADS

TYPE BMC-Q SERIES

INTRODUCTION

TE Connectivity (TE) introduces its automotive grade multilayer chip bead inductors. The BMC-Q series are designed with a monolithic inorganic material construction. The inductors are designed for high and ultra-high current capability and are AEC-Q200 compliant. The inductors are available in 0402, 0603, 0805 and 1204 packaging sizes.

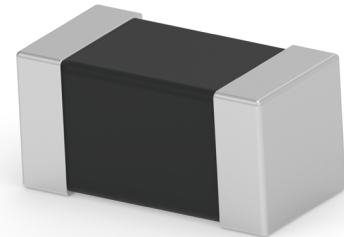

FEATURES

- Effective EMI protection
- Low DC resistance
- Multiple size availability
- AEC-Q200 qualified
- Moisture sensitivity level – MSL1

APPLICATIONS

- Automotive multi-media system
- Wireless connection system
- Body comfort system
- Automotive low power systems

Note: Not recommended for automotive power systems and/or safety management systems without special clarifications. Please consult with TE for feasibility evaluation based on your design requirements.

Electrical Characteristics

BMC-Q 0402: High Current

Part No.	Impedance (Ω)	Tolerance	Test Condition	DCR (Ω) max.	Rated Current (mA) max.
BMC-Q1E0000H	ZR	0-15 Ω	100 MHz, 50 mV	0.04	800
BMC-Q1E0005H	5R0				
BMC-Q1E0007H	7R0	0-11 Ω			
BMC-Q1E0009H	9R0	5-13 Ω			
BMC-Q1E0011H	11R	7-15 Ω			
BMC-Q1E0015H	15R	9-21 Ω			
BMC-Q1E0019H	19R	12-25 Ω		0.06	700
BMC-Q1EY0026H	26R	$\pm 25\%$		0.08	
BMC-Q1EY0031H	31R			0.15	600
BMC-Q1EY0036H	36R				
BMC-Q1EY0050H	50R				
BMC-Q1EY0060H	60R				
BMC-Q1EY0070H	70R		0.2	450	

Automotive Grade Multilayer Chip Beads

Type BMC-Q Series

BMC-Q 0402: High Current

Part No.	Impedance (Ω)	Tolerance	Test Condition	DCR (Ω) max.	Rated Current (mA) max.
BMC-Q1EY0075H	75R	$\pm 25\%$	100 MHz, 50 mV	0.2	450
BMC-Q1EY0080H	80R				
BMC-Q1EY0100H	100R				
BMC-Q1EY0120H	120R			0.25	300
BMC-Q1EY0150H	150R				
BMC-Q1EY0180H	180R			0.4	300
BMC-Q1EY0220H	220R				
BMC-Q1EY0300H	300R			0.5	200
BMC-Q1EY0500H	500R				
BMC-Q1EY0600H	600R				
BMC-Q1EY0800H	800R				
BMC-Q1EY1000H	1K0				

BMC-Q 0603: High Current

Part No.	Impedance (Ω)	Tolerance	Test Condition	DCR (Ω) max.	Rated Current (mA) max.
BMC-Q1J0000H	ZR	0-15 Ω	100 MHz, 50 mV	0.080	1000
BMC-Q1J0005H	5R0				
BMC-Q1J0007H	7R0	0-11 Ω			
BMC-Q1J0009H	9R0	5-13 Ω			
BMC-Q1J0011H	11R	7-15 Ω			
BMC-Q1J0015H	15R	9-21 Ω			
BMC-Q1J0019H	19R	12-25 Ω			
BMC-Q1JY0026H	26R	$\pm 25\%$		0.120	1000
BMC-Q1JY0030H	30R				
BMC-Q1JY0031H	31R			0.150	1000
BMC-Q1JY0050H	50R				
BMC-Q1JY0060H	60R			0.200	1000
BMC-Q1JY0070H	70R				
BMC-Q1JY0080H	80R		0.250	1000	
BMC-Q1JY0100H	100R				
BMC-Q1JY0120H	120R		0.300	1000	
BMC-Q1JY0150H	150R				
BMC-Q1JY0180H	180R		0.550	500	
BMC-Q1JY0220H	220R				
BMC-Q1JY0300H	300R		0.550	500	
BMC-Q1JY0500H	500R				
BMC-Q1JY0600H	600R	0.550	500		
BMC-Q1JY0800H	800R				
BMC-Q1JY1000H	1K0	0.550	500		

Automotive Grade Multilayer Chip Beads

Type BMC-Q Series

BMC-Q 0805: High Current

Part No.	Impedance (Ω)	Tolerance	Test Condition	DCR (Ω) max.	Rated Current (mA) max.
BMC-Q2A0000H	ZR	0-15 Ω	100 MHz, 50 mV	0.030	3000
BMC-Q2A0005H	5R0				
BMC-Q2A0007H	7R0	0-11 Ω			
BMC-Q2A0009H	9R0	5-13 Ω			
BMC-Q2A0011H	11R	7-15 Ω			
BMC-Q2A0015H	15R	9-21 Ω			
BMC-Q2A0019H	19R	12-25 Ω		0.050	2500
BMC-Q2AY0030H	30R	$\pm 25\%$			
BMC-Q2AY0031H	31R				
BMC-Q2AY0036H	36R				
BMC-Q2AY0060H	60R				
BMC-Q2AY0070H	70R				
BMC-Q2AY0080H	80R				
BMC-Q2AY0100H	100R				
BMC-Q2AY0120H	120R				
BMC-Q2AY0150H	150R				
BMC-Q2AY0180H	180R				
BMC-Q2AY0200H	200R				
BMC-Q2AY0220H	220R				
BMC-Q2AY0300H	300R				
BMC-Q2AY0500H	500R				
BMC-Q2AY0600H	600R				
BMC-Q2AY0800H	800R				
BMC-Q2AY1000H	1K0				
BMC-Q2AY1200H	1.2K0				
BMC-Q2AY1500H	1.5K0				
				0.060	
				0.080	
				0.100	
				0.150	2000
				0.200	
				0.250	1500
				0.300	800
				0.450	500
				0.500	300

BMC-Q 1204: High Current

Part No.	Impedance (Ω)	Tolerance	Test Condition	DCR (Ω) max.	Rated Current (mA) max.
BMC-Q2C0000H	ZR	0-15 Ω	100 MHz, 50 mV	0.040	4000
BMC-Q2C0005H	5R0	0-15 Ω			
BMC-Q2C0007H	7R0	0-11 Ω			
BMC-Q2C0009H	9R0	5-13 Ω		0.050	3000
BMC-Q2C0011H	11R	7-15 Ω			
BMC-Q2C0015H	15R	9-21 Ω			
BMC-Q2C0019H	19R	12-25 Ω		$\pm 25\%$	0.070
BMC-Q2CY0026H	26R	$\pm 25\%$			
BMC-Q2CY0028H	28R				
BMC-Q2CY0030H	30R				
BMC-Q2CY0031H	31R				

Automotive Grade Multilayer Chip Beads

Type BMC-Q Series

BMC-Q 1204: High Current

Part No.	Impedance (Ω)	Tolerance	Test Condition	DCR (Ω) max.	Rated Current (mA) max.
BMC-Q2CY0050H	50R	$\pm 25\%$	100 MHz, 50 mV	0.070	3000
BMC-Q2CY0060H	60R				
BMC-Q2CY0070H	70R				
BMC-Q2CY0080H	80R				
BMC-Q2CY0100H	100R				
BMC-Q2CY0120H	120R				
BMC-Q2CY0150H	150R			0.120	2500
BMC-Q2CY0180H	180R				
BMC-Q2CY0220H	220R				
BMC-Q2CY0300H	300R			0.150	2000
BMC-Q2CY0500H	500R				
BMC-Q2CY0600H	600R			0.200	
BMC-Q2CY0800H	800R				
BMC-Q2CY1000H	1K Ω			0.250	
BMC-Q2CY1200H	1.2K Ω				
BMC-Q2CY1500H	1.5K Ω				
				0.350	1000
				0.450	500

BMC-Q 0402: Ultra High Current

Part No.	Impedance (Ω)	Tolerance	Test Condition	DCR (Ω) max.	Rated Current (mA) max.
BMC-Q1E0000M	ZR	0-15 Ω	100 MHz, 50 mV	0.050	1800
BMC-Q1E0005M	5R Ω	0-15 Ω			
BMC-Q1E0007M	7R Ω	0-11 Ω			
BMC-Q1E0009M	9R Ω	5-13 Ω			
BMC-Q1E0011M	11R	7-15 Ω			
BMC-Q1E0015M	15R	9-21 Ω			
BMC-Q1E0019M	19R	12-25 Ω			
BMC-Q1EY0030M	30R	$\pm 25\%$		0.060	1500
BMC-Q1EY0060M	60R			0.080	1300
BMC-Q1EY0070M	70R			0.100	1000
BMC-Q1EY0080M	80R			0.150	800
BMC-Q1EY0100M	100R				
BMC-Q1EY0120M	120R				
BMC-Q1EY0150M	150R			0.200	700
BMC-Q1EY0200M	200R				
BMC-Q1EY0220M	220R			0.250	600
BMC-Q1EY0300M	300R				
BMC-Q1EY0500M	500R			0.300	500
BMC-Q1EY0600M	600R				
BMC-Q1EY0800M	800R			0.400	500
BMC-Q1EY1000M	1K Ω				
			0.500		
			0.650	300	

Automotive Grade Multilayer Chip Beads

Type BMC-Q Series

BMC-Q 0603: Ultra High Current

Part No.	Impedance (Ω)	Tolerance	Test Condition	DCR (Ω) max.	Rated Current (mA) max.
BMC-Q1J0000M	ZR	0-15 Ω	100 MHz, 50 mV	0.020	6000
BMC-Q1J0005M	5R0				
BMC-Q1J0007M	7R0	0-11 Ω			
BMC-Q1J0009M	9R0	5-13 Ω			
BMC-Q1J0011M	11R	7-15 Ω		0.030	5000
BMC-Q1J0015M	15R	9-21 Ω			
BMC-Q1J0019M	19R	12-25 Ω			
BMC-Q1JY0030M	30R	$\pm 25\%$			
BMC-Q1JY0050M	50R				
BMC-Q1JY0060M	60R			0.060	2500
BMC-Q1JY0070M	70R				
BMC-Q1JY0080M	80R				
BMC-Q1JY0100M	100R				
BMC-Q1JY0120M	120R			0.065	2000
BMC-Q1JY0150M	150R			0.090	1500
BMC-Q1JY0180M	180R				
BMC-Q1JY0220M	220R			0.120	
BMC-Q1JY0300M	300R			0.180	
BMC-Q1JY0500M	500R				
BMC-Q1JY0600M	600R				0.300
BMC-Q1JY0800M	800R				
BMC-Q1JY1000M	1K0	0.400	600		

BMC-Q 0805: Ultra High Current

Part No.	Impedance (Ω)	Tolerance	Test Condition	DCR (Ω) max.	Rated Current (mA) max.	
BMC-Q2A0000M	ZR	0-15 Ω	100 MHz, 50 mV	0.010	6000	
BMC-Q2A0005M	5R0					
BMC-Q2A0007M	7R0	0-11 Ω				
BMC-Q2A0009M	9R0	5-13 Ω				
BMC-Q2A0011M	11R	7-15 Ω				
BMC-Q2A0015M	15R	9-21 Ω				
BMC-Q2A0019M	19R	12-25 Ω				
BMC-Q2AY0030M	30R	$\pm 25\%$		0.040	3500	
BMC-Q2AY0031M	31R					
BMC-Q2AY0050M	50R				0.050	3000
BMC-Q2AY0060M	60R					
BMC-Q2AY0070M	70R					
BMC-Q2AY0080M	80R					
BMC-Q2AY0100M	100R			0.080	2500	
BMC-Q2AY0120M	120R					
BMC-Q2AY0150M	150R					

Automotive Grade Multilayer Chip Beads

Type BMC-Q Series

BMC-Q 0805: Ultra High Current

Part No.	Impedance (Ω)	Tolerance	Test Condition	DCR (Ω) max.	Rated Current (mA) max.
BMC-Q2AY0180M	180R	$\pm 25\%$	100 MHz, 50 mV	0.080	2500
BMC-Q2AY0220M	220R				
BMC-Q2AY0300M	300R				
BMC-Q2AY0500M	500R			0.100	2000
BMC-Q2AY0600M	600R				
BMC-Q2AY1000M	1K0				

BMC-Q 1204: Ultra High Current

Part No.	Impedance (Ω)	Tolerance	Test Condition	DCR (Ω) max.	Rated Current (mA) max.
BMC-Q2C0000M	ZR	0-15 Ω	100 MHz, 50 mV	0.010	6000
BMC-Q2C0005M	5R0	0-11 Ω			
BMC-Q2C0007M	7R0	5-13 Ω			
BMC-Q2C0009M	9R0	7-15 Ω			
BMC-Q2C0011M	11R	9-21 Ω			
BMC-Q2C0015M	15R	12-25 Ω			
BMC-Q2C0019M	19R	$\pm 25\%$		0.015	4000
BMC-Q2CY0026M	26R				
BMC-Q2CY0028M	28R				
BMC-Q2CY0030M	30R				
BMC-Q2CY0031M	31R				
BMC-Q2CY0050M	50R				
BMC-Q2CY0060M	60R			0.025	3000
BMC-Q2CY0070M	70R				
BMC-Q2CY0080M	80R				
BMC-Q2CY0100M	100R				
BMC-Q2CY0120M	120R				
BMC-Q2CY0150M	150R				
BMC-Q2CY0180M	180R			0.035	2500
BMC-Q2CY0220M	220R				
BMC-Q2CY0300M	300R				
BMC-Q2CY0500M	500R				
BMC-Q2CY0600M	600R				
BMC-Q2CY0800M	800R				
BMC-Q2CY1000M	1K0	0.045	2000		
		0.055			
		0.065			
		0.085			
		0.100			
		0.110			
		0.120			

Automotive Grade Multilayer Chip Beads

Type BMC-Q Series

Environmental Characteristics

Item	Requirement	Test Condition
High Temperature Exposure	No mechanical damage Impedance value should be within $\pm 30\%$ of the initial value.	MIL-STD-202 Method 108 Temperature: +125 °C, duration: 1000 hrs. Measurement at 24 \pm 4 hrs after test conclusion.
Temperature Cycle	No mechanical damage Impedance value should be within $\pm 30\%$ of the initial value.	JESD22 Method JA-104 Temperature: -40 °C to +125 °C, severity: 1000 cycles. Measurement at 24 \pm 4 hrs after test conclusion.
Biased Humidity	No mechanical damage Impedance value should be within $\pm 30\%$ of the initial value.	MIL-STD-202 Method 103 Duration: 1000 hrs, temperature: 85 °C/85% RH. Unpowered. Measurement at 24 \pm 4 hrs after test conclusion.
Operational Life	No mechanical damage Impedance value should be within $\pm 30\%$ of the initial value.	MIL-STD-202 Method 108 Temperature: +125 °C, duration: 1000 hrs. Test current: half of rated current at normal temperature Measurement at 24 \pm 4 hrs after test conclusion.
Mechanical Shock	No mechanical damage Impedance value should be within $\pm 30\%$ of the initial value.	MIL-STD-202 Method 213 Wave Form: Tolerance for half sine shock pulse. Peak value is 100 g's. Normal duration (D) is 6. Three shocks in each direction shall be applied along the three mutually perpendicular axes of the test specimen (18 shocks).
Vibration	No mechanical damage Impedance value should be within $\pm 30\%$ of the initial value.	MIL-STD-202 Method 204 5 g's for 20 min., 12 cycles each of 3 orientations, 10-2000 Hz.
Resistance to Solder Heat	No mechanical damage Impedance value should be within $\pm 30\%$ of the initial value.	Temperature: 260 \pm 5 °C, duration: 10 \pm 1 seconds.
Solderability	More than 95% of electrode area should be coated by new solder.	Temperature: 245 \pm 5 °C, duration: 3 \pm 0.3 seconds.
Board Flex	No mechanical damage. Impedance value should be within $\pm 30\%$ of the initial value.	The testing samples shall be mounted on a 100 mm \times 40 mm FR4 PCB board, which is 1.6 mm \pm 0.2 mm thick. Bending shall be applied to the 2.0 mm with 1.0 mm/sec. Duration, 60 \pm 5 s.
Terminal Strength	No mechanical damage Impedance value should be within $\pm 30\%$ of the initial value.	The testing samples shall be mounted on the testing epoxy boards, exerting force on side of the samples, Size 1005: 5 N ; \geq Size 1608: 17.7 N, Duration 60 \pm 1 s.

- Operating Temperature: -40 °C ~ 125 °C (Including self heating temperature rise.)
- Storage Temperature: -10 °C ~ 40 °C; Humidity: 30-70% RH

Automotive Grade Multilayer Chip Beads

Type BMC-Q Series

Construction

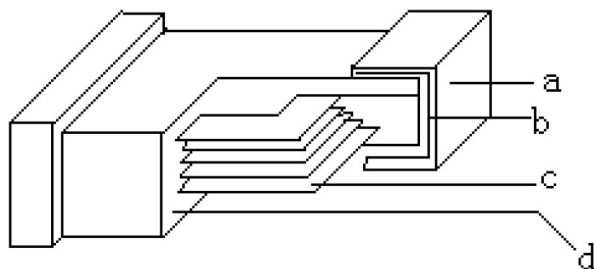

a	Edge Electrode
b	External Electrode
c	Inner electrode
d	Ferrite

Dimensions (Unit: mm)

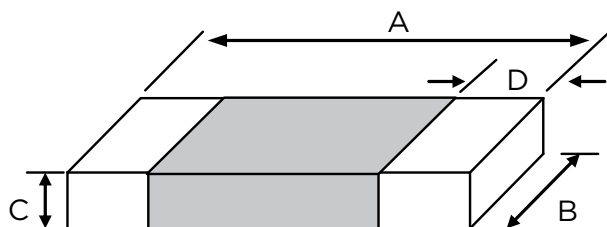

Type	Size (Inch)	A (mm)	B (mm)	C (mm)	D (mm)
BMC-Q1E	0402	1.00 ±0.15	0.50 ±0.15	0.50 ±0.15	0.25 ±0.10
BMC-Q1J	0603	1.60 ±0.20	0.80 ±0.20	0.80 ±0.20	0.30 ±0.20
BMC-Q2A	0805	2.00 ±0.20	1.20 ±0.20	0.90 ±0.20	0.50 ±0.30
BMC-Q2C	1204	3.20 ±0.20	1.60 ±0.20		

Recommended PCB layout plan (Unit: mm)

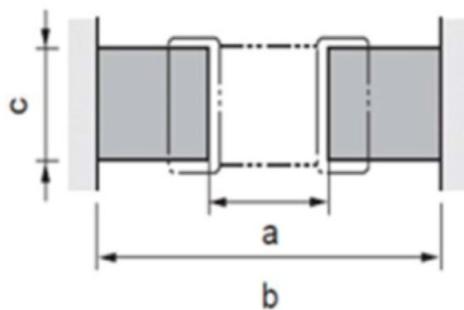

Type	Size (Inch)	A (mm)	B (mm)	C (mm)
BMC-Q1E	0402	0.40	1.50	0.60
BMC-Q1J	0603	0.90	2.20	0.80
BMC-Q2A	0805	1.20	3.00	1.00
BMC-Q2C	1204	1.20	4.50	1.50

Automotive Grade Multilayer Chip Beads

Type BMC-Q Series

Soldering Condition

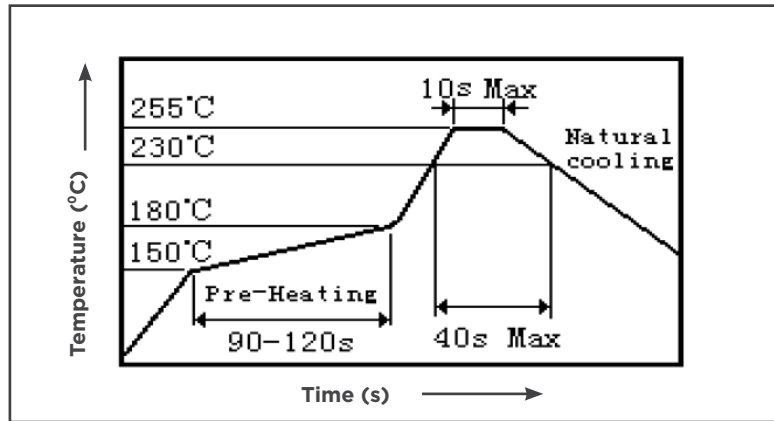

Packaging

Packaging Quantity & Reel Specifications (Unit: mm)

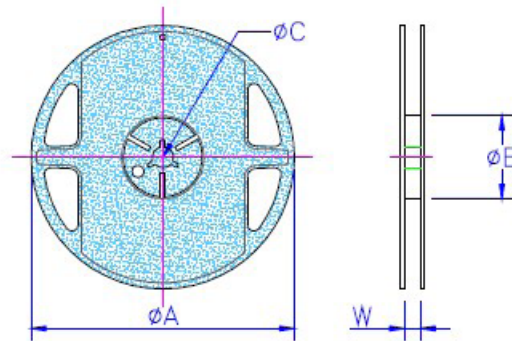

Type	Size (Inch)	ΦA	ΦB	ΦC	W	Quantity (EA)
BMC-Q1E	0402	178 ±2.0	57 ±2.0	12.5 ±1.5	8 +1.5/-0	10,000
BMC-Q1J	0603					4,000
BMC-Q2A	0805					
BMC-Q2C	1204					

Paper Tape Specifications (Unit: mm)

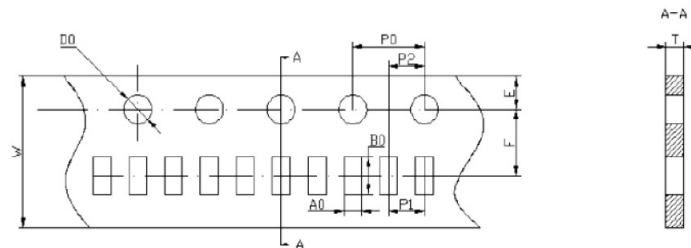

Type	A0	B0	W	E	F	P0	P1	P2	D0	T
BMC-Q1E	0.65 ±0.10	1.15 ±0.20	8.0 ±0.20	1.75 ±0.20	3.5 ±0.10	4.00 ±0.20	2.00 ±0.10	2.00 ±0.10	1.55 ±0.10	0.60 ±0.10
BMC-Q1J	1.10 ±0.20	1.90 ±0.20					4.00 ±0.20			0.95 ±0.10
BMC-Q2A	1.50 ±0.20	2.30 ±0.20								
BMC-Q2C	1.90 ±0.20	3.50 ±0.20								

ORDERING INFORMATION

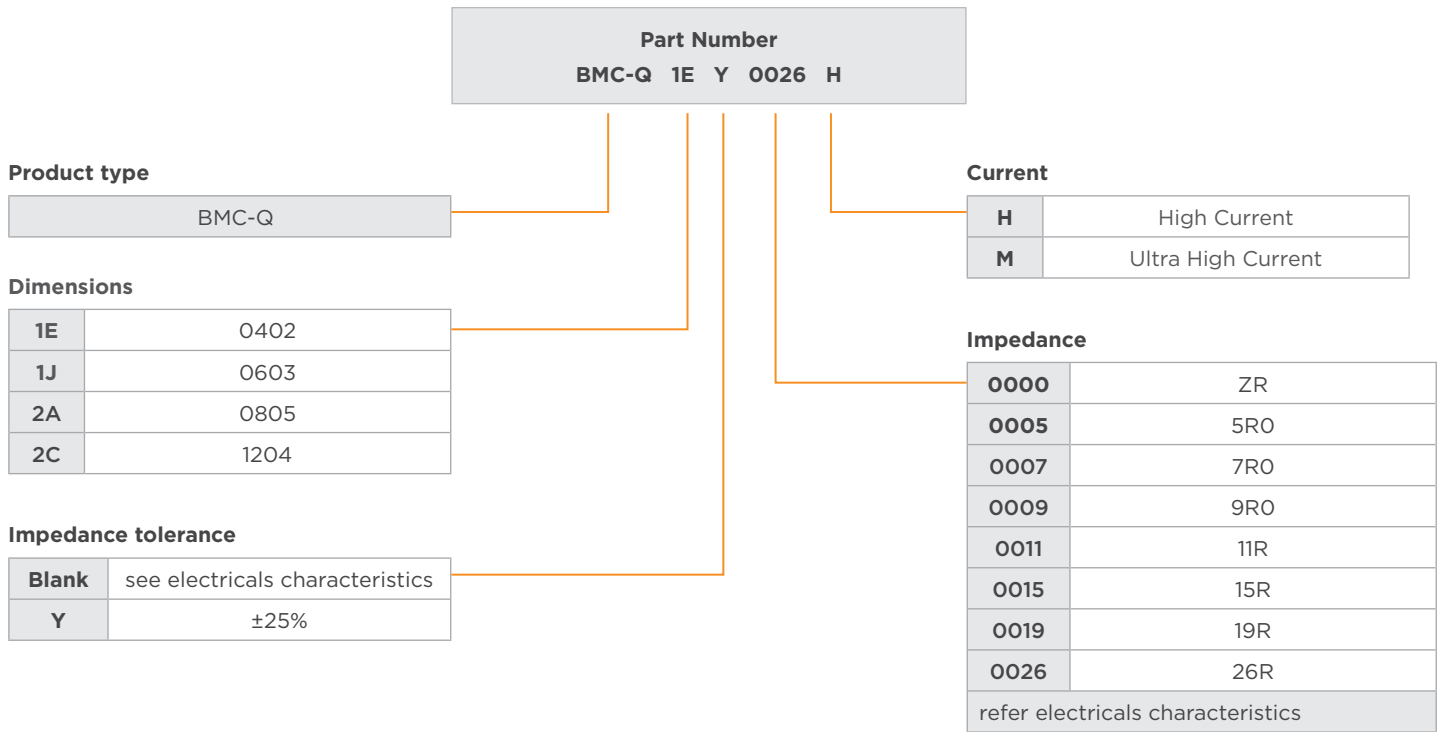

[te.com](https://www.te.com)

©2024 TE Connectivity Ltd. All Rights Reserved.

TE Connectivity, TE connectivity (logo) and Every Connection Counts are trademarks owned or licensed by the TE Connectivity Ltd. family of companies. All other logos, products and/or company names referred to herein might be trademarks of their respective owners.

While TE has made every reasonable effort to ensure the accuracy of the information in this document, TE does not guarantee that it is error-free, nor does TE make any other representation, warranty or guarantee that the information is accurate, correct, reliable or current. TE reserves the right to make any changes to the information contained herein without prior notice. TE Connectivity assumes only those obligations set forth in the terms and conditions for this product and shall in no event be liable for any incidental, indirect, or consequential damages arising out of the sale, resale, use, or misapplication of the product. TE expressly disclaims any implied warranties with respect to the information contained herein, including, but not limited to, implied warranties of merchantability or fitness for a particular purpose. Dimensions, specifications and/or information contained herein are for reference purposes only and are subject to change without notice. Consult TE for the latest dimensions, specifications and/or information. Users of TE Connectivity products must make their own assessment as to whether the respective product is suitable for the respective desired application.

08/24 1773178-3 ED