

SMD AEC-Q200 COMPLIANT THICK FILM CHIP RESISTOR

TYPE CRGCQ SERIES

INTRODUCTION

TE Connectivity is pleased to introduce our AEC-Q200 compliant thick film Chip resistor, suitable for auto placement in volume and for most applications. Available in seven different packages and supplied on tape and reel for automatic insertion processes. Standard values - E24 Series.

FEATURES

- Small size and light weight
- Suitable for both wave and reflow soldering techniques
- Supplied on tape
- AEC-Q200 Compliant
- 7 different package sizes
- Terminal finish matte Sn over Ni
- Moisture Sensitive Level 1



INDUCTANCE AND RATED CURRENT RANGES

Type	CRGCQ0402	CRGCQ0603	CRGCQ0805	CRGCQ1206	CRGCQ1210	CRGCQ2010	CRGCQ2512
Power Rating @ 70°C	0.0625W	0.1W	0.125W	0.25W	0.5W	0.75W	1W
Jumper Rated current	1A	1A	2A	2A	2A	2A	2A
Max. Jumper Current	2A	2A	5A	10A	10A	10A	10A
Max. Working Voltage	50V	75V	150V	200V	200V	200V	200V
Max. Overload Voltage	100V	150V	300V	400V	500V	500V	500V
Dielectric Withstand Voltage	100V	300V	500V	500V	500V	500V	500V
Jumper resistance	<50mΩ						
Temperature Range	-55°C - +155°C						
Ambient Temperature	70°C						

SMD AEC-Q200 Compliant Thick Film Chip Resistor

Type CRGCQ series

ENVIRONMENTAL CHARACTERISTICS

Characteristics	Limits	Test Methods	
Load life	±1%: ±(1.0%+0.1Ω)Max. ±5%: ±(3.0%+0.1Ω)Max.	125°C, 35% power, at RCWV or Max. Working Voltage whichever less, 1,000 hours (1.5 hours "ON", 0.5 hours "OFF"), Measurement at 24±2 hours after test conclusion. (MIL-STD-202 Method 108)	
Temperature coefficient	1Ω ≤ R ≤ 10Ω: ±400PPM/°C 10Ω < R ≤ 100Ω: ±200PPM/°C R > 100Ω: ±100PPM/°C	Measure between -55°C ~ +125°C	
Short-time overload	±1%: ±(1.0%+0.1Ω) Max. ±5%: ±(2.0%+0.1Ω) Max.	2.5x Rated voltage or Max. Overload Voltage whichever is lower for 5 seconds, then check the resistance.	
Terminal bending	±(1.0%+0.05Ω) Max.	Bending Distance 3mm, Duration: 60s±5s, then check the resistance	
Solderability	95% coverage Min.	245±3°C; 2-3s	
Soldering heat	±(1.0%+0.05Ω) Max.	260±5°C; 10±1s	
Moisture resistance	1%: ± (0.5%+0.1Ω) Max. 5%: ± (3.0%+0.1Ω) Max.	25°C-65°C, 90-100%RH, 2.5Hr; 65°C 90-100%RH, 3Hr; 65°C-25°C 80-100%RH, 2.5Hr, 10 cycles. Measurement at 24 hours after test conclusion (MIL-STD-202 Method 106)	
Biased humidity	1%: ± (1.0%+0.1Ω) Max. 5%: ± (3.0%+0.1Ω) Max.	10% rated power, 85°C/85%RH, 1000Hr. Measurement at 24 hours after test conclusion. (MIL-STD-202 Method 103)	
Dielectric withstand voltage	No evidence of flashover, mechanical damage, arcing or insulation breakdown	Resistor shall be clamped in the trough of 90° metallic V-block and shall be tested at AC potential respectively specified in the given list of each product type for 60-70s.	
Temperature cycling	1%: ± (0.5%+0.1Ω) Max. 5%: ± (1.0%+0.1Ω) Max.	-55±3°C 30min -normal temperature 10min-15min-155±2°C 30min-normal temperature 10min-15min 1000 cycles. Measurement at 24 hours after test conclusion. (JESD22 Method JA-104)	
ESD	±(1.0%+0.05Ω) Max.		
	Chip Size	ESD	Class
	0402	0.6kv	1B
	0603	1kv	1C
	0805	1.3kv	1C
	1206	2.1kv	2
	1210	3.9kv	2
	2010	10kv	5A
2512	17kv	5C	
Sulfuration test	1%: ± (1.0%+0.1Ω) Max. 5%: ± (5.0%+0.1Ω) Max.	H2S 3-5PPM 50°C±2°C 91%-93% RH 1000H	

SMD AEC-Q200 Compliant Thick Film Chip Resistor

Type CRGCQ series

POWER DERATING CURVE

Power rating based on continuous load operation in ambient temperature of -55 - 70°C. For resistors operated in ambient temperatures above 70°C, power rating must be derated in accordance with this curve.

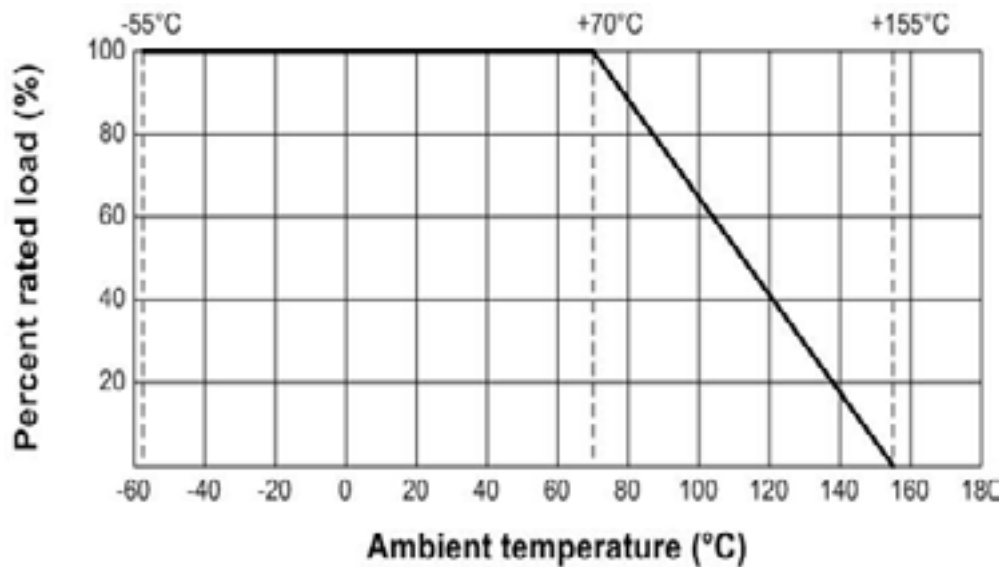

PULSE CHARACTERISTICS

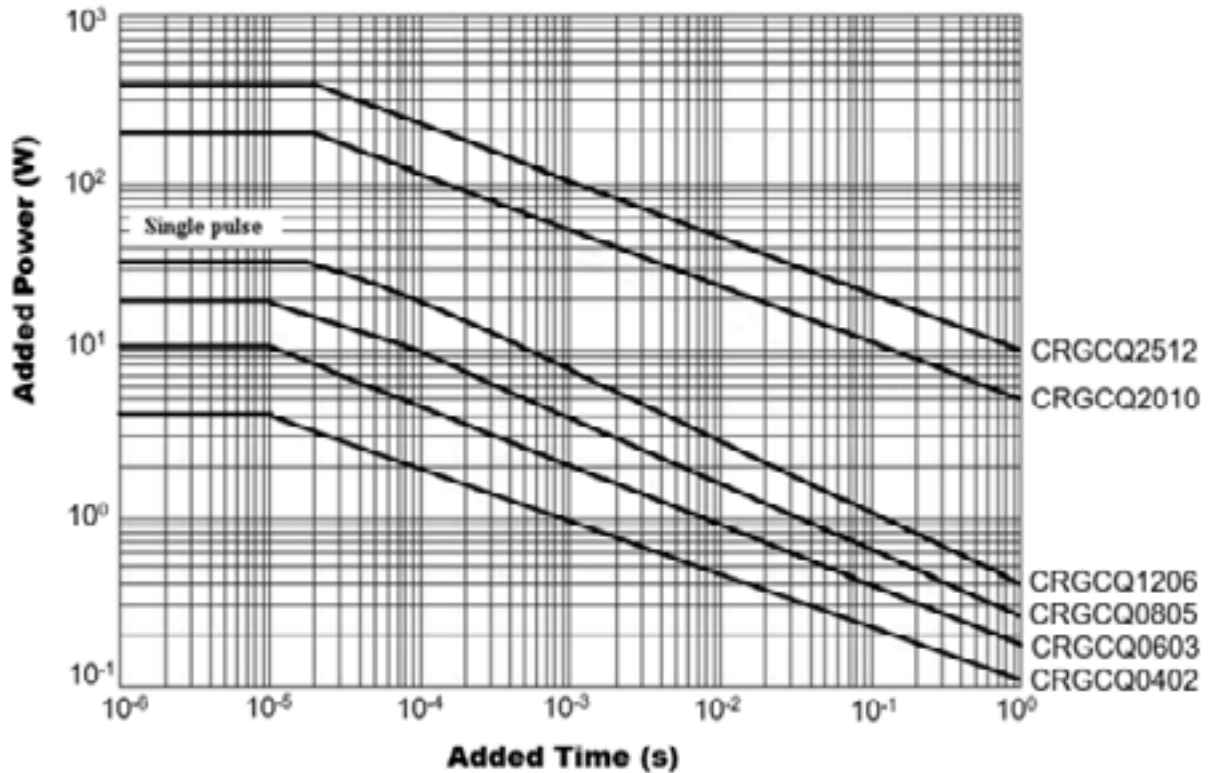

SMD AEC-Q200 Compliant Thick Film Chip Resistor

Type CRGCQ series

DIMENSIONS

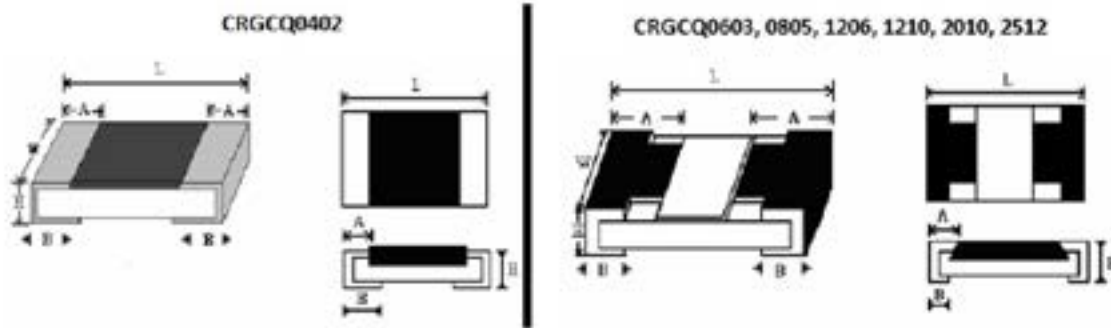

Type	Dimension (mm)				
	L	W	H	A	B
CRGCQ0402	1.00±0.10	0.50±0.05	0.35±0.05	0.20±0.10	0.25±0.10
CRGCQ0603	1.60±0.10	0.80±0.10	0.45±0.10	0.30±0.20	0.30±0.20
CRGCQ0805	2.00±0.15	1.25+0.15/-0.10	0.55±0.10	0.40±0.20	0.40±0.20
CRGCQ1206	3.10±0.15	1.55+0.15/-0.10	0.55±0.10	0.45±0.20	0.45±0.20
CRGCQ1210	3.10±0.10	2.60±0.20	0.55±0.10	0.50±0.25	0.50±0.20
CRGCQ2010	5.00±0.10	2.50±0.20	0.55±0.10	0.60±0.25	0.50±0.20
CRGCQ2512	6.35±0.10	3.20±0.20	0.55±0.10	0.60±0.25	0.50±0.20

CONSTRUCTION

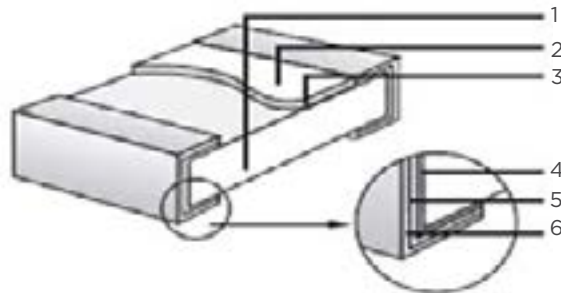

1. High purity alumina substrate
2. Protective coating
3. Resistive element
4. Termination (inner) Ni/Cr
5. Termination (between) Ni Barrier
6. Termination (outer) Sn

SMD AEC-Q200 Compliant Thick Film Chip Resistor

Type CRGCQ series

POWER RATING AND RESISTANCE RANGE

Type	Power Rating @ 70°C	Tolerance	Resistance Range	Standard Series
CRGCQ0402	0.0625W	Jumper	< 50mΩ	E24 E96 by negotiation
		±1%	1R0 - 10M	
		±5%	1R0 - 10M	
CRGCQ0603	0.1W	Jumper	< 50mΩ	E24 E96 by negotiation
		±1%	1R0 - 10M	
		±5%	1R0 - 10M	
CRGCQ0805	0.125W	Jumper	< 50mΩ	E24 E96 by negotiation
		±1%	1R0 - 10M	
		±5%	1R0 - 10M	
CRGCQ1206	0.25W	Jumper	< 50mΩ	E24 E96 by negotiation
		±1%	1R0 - 10M	
		±5%	1R0 - 10M	
CRGCQ1210	0.5W	Jumper	< 50mΩ	E24 E96 by negotiation
		±1%	1R0 - 10M	
		±5%	1R0 - 10M	
CRGCQ2010	0.75W	Jumper	< 50mΩ	E24 E96 by negotiation
		±1%	1R0 - 10M	
		±5%	1R0 - 10M	
CRGCQ2512	1W	Jumper	< 50mΩ	E24 E96 by negotiation
		±1%	1R0 - 10M	
		±5%	1R0 - 10M	

MARKING

E24 series 0603 - 2512 3 Digits - first two digits denote significant figures of resistance and third digit denotes number of zeros thereafter. EG

	222	
--	-----	--

 =
 2K2

Marking for E96 Series 0805 - 2512 4 digits - First three digits denote significant figures of resistance and fourth digit denotes number of zeros thereafter. EG.

	1000	
--	------	--

 =
 100R

For ohmic values below 100R letter "R" denotes decimal point. EG

	1R80	
--	------	--

 =
 1R8 / 1.8Ω

0402 size chips are not marked

0603 E96 3 digit marking.

SMD AEC-Q200 Compliant Thick Film Chip Resistor

Type CRGCQ series

MULTIPLIER CODE

Code	A	B	C	D	E	F	G	H	X	Y	Z
Mutiplier	10 ⁰	10 ¹	10 ²	10 ³	10 ⁴	10 ⁵	10 ⁶	10 ⁷	10 ⁻¹	10 ⁻²	10 ⁻³

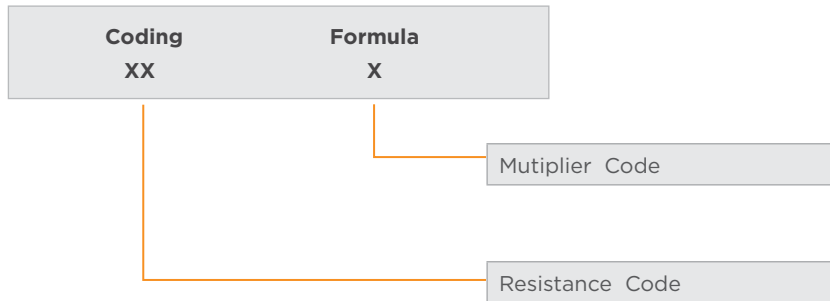

Example:

10.2K Ω = 102 X 10 Ω = 2C
 \downarrow \downarrow
 02 C

33.2 Ω = 332 X 10⁻¹ Ω = 51X
 \downarrow \downarrow
 51 X

Value	Code	Value	Code	Value	Code	Value	Code
100	01	191	28	365	55	698	82
102	02	196	29	374	56	715	83
105	03	200	30	383	57	732	84
107	04	205	31	392	58	750	85
110	05	210	32	402	59	768	86
113	06	215	33	412	60	787	87
115	07	221	34	422	61	806	88
118	08	226	35	432	62	825	89
121	09	232	36	442	63	845	90
124	10	237	37	453	64	866	91
127	11	243	38	464	65	887	92
130	12	249	39	475	66	909	93
133	13	255	40	487	67	931	94
137	14	261	41	499	68	953	95
140	15	267	42	511	69	976	96
143	16	274	43	523	70		
147	17	280	44	536	71		
150	18	287	45	549	72		
154	19	294	46	562	73		
158	20	301	47	576	74		
162	21	309	48	590	75		
165	22	316	49	604	76		
169	23	324	50	619	77		
174	24	332	51	634	78		
178	25	340	52	649	79		
182	26	348	53	665	80		
187	27	357	54	681	81		

Marking for E96 series 0603 size with no marking code marked as per E24 values.

SMD AEC-Q200 Compliant Thick Film Chip Resistor

Type CRGCQ series

PACKAGING SPECIFICATION

Paper taping

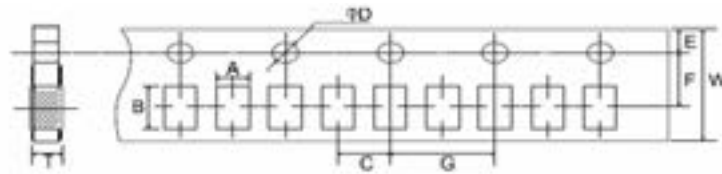

Type	A ± 0.2	B ± 0.2	C ± 0.05	ØD +0.1 -0	E ± 0.1	F ± 0.05	G ± 0.1	W ± 0.2	T ± 0.1
0402	0.65	1.15	2.0	1.5	1.75	3.5	4.0	8.0	0.45
0603	1.10	1.90	2.0	1.5	1.75	3.5	4.0	8.0	0.67
0805	1.65	2.40	2.0	1.5	1.75	3.5	4.0	8.0	0.81
1206	2.00	3.60	2.0	1.5	1.75	3.5	4.0	8.0	0.81
1210	2.80	3.50	2.0	1.5	1.75	3.5	4.0	8.0	0.75
2010	2.80	5.40	2.0	1.5	1.75	3.5	4.0	12.0	0.75

Embossed Taping

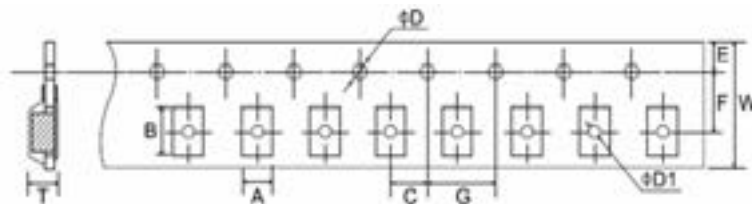

Type	A ± 0.2	B ± 0.2	C ± 0.05	ØD +0.1 -0	ØD1 +0.1 -0	E ± 0.1	F ± 0.05	G ± 0.1	W ± 0.2	T ± 0.1
2512	3.50	6.70	2.0	1.5	1.5	1.75	5.5	4.0	12.0	1.0

Peeling strength of cover tape:

Test condition: 0.1 to 0.7 N at a peel off speed of 300mm / min.

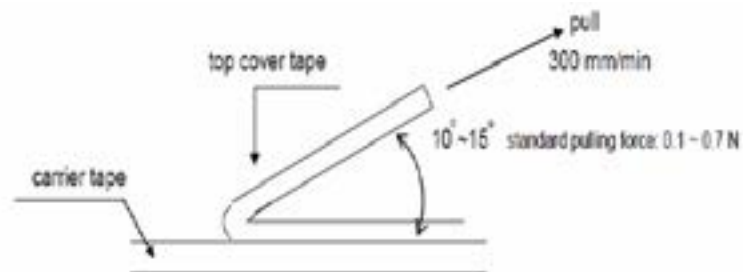

SMD AEC-Q200 Compliant Thick Film Chip Resistor

Type CRGCQ series

REEL DIMENSIONS (mm)

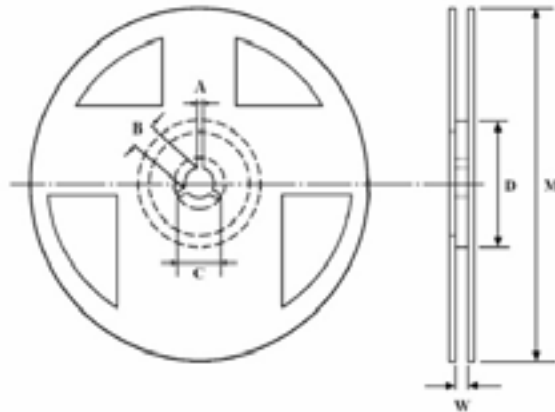

Type	Tape	Reel Qty	A ± 0.5	B ± 0.5	C ± 0.5	D ± 1	M ± 2	W ± 1
0402	Paper	10,000	2	13	21	60	178	10
0603	Paper	5,000	2	13	21	60	178	10
0805	Paper	5,000	2	13	21	60	178	10
1206	Paper	5,000	2	13	21	60	178	10
1210	Paper	5,000	2	13	21	60	178	10
2010	Paper	4,000	2	13	21	60	178	13.8
2512	Embossed	4,000	2	13	21	60	178	13.8

LABEL

1. TE Product Number
2. Product Description
3. Quantity
4. Lot Number
5. RoHS Statement

Example

TYCO Pn	CRGCQ0603F100R		
DESC	CRGCQ 0603 100R 1%		
QTY	5000 Pcs.	PPM:	
LOT	SAMPLE		
REF	RoHS 2011/65/EU		
			

SMD AEC-Q200 Compliant Thick Film Chip Resistor

Type CRGCQ series

ENVIRONMENT RELATED SUBSTANCE

This product complies to EU RoHS directive, EU PAHs directive, EU PFOS directive and Halogen free.

OZONE LAYER DEPLETING SUBSTANCES

Ozone depleting substances are not used in our manufacturing process of this product.

This product is not manufactured using Chloro fluorocarbons (CFCs), Hydrochlorofluorocarbons (HCFCs), Hydrobromofluorocarbons (HBFCs) or other ozone depleting substances in any phase of the manufacturing process.

STORAGE CONDITION (MSL1)

The performance of these products, including the solderability, is guaranteed for a year from the date of arrival at your company, provided that they remain packed as they were when delivered and stored at a temperature of $25^{\circ}\text{C} \pm 10^{\circ}\text{C}$ and a relative humidity of $60\%RH \pm 10\%RH$, chemical and dust free atmosphere

Even within the above guarantee periods, do not store these products in the following conditions otherwise, their electrical performance and/or solderability may be deteriorated, and the packaging materials (e.g. taping materials) may be deformed or deteriorated, resulting in mounting failures.

1. In salty air or in air with a high concentration of corrosive gas, such as Cl_2 , H_2S , NH_3 , SO_2 , or NO_2
2. In direct sunlight

SOLDER PROFILE

Wave soldering condition: (2 cycles Max.)

Pre-heat : $100 - 120^{\circ}\text{C}$, 30 ± 5 sec.

Peak temp.: 260°C

Reflow soldering condition: (2 cycles Max.)

Pre-heat : $150 - 180^{\circ}\text{C}$, $90 - 120$ sec.

Suggestion solder temp.: $235 - 255^{\circ}\text{C}$, $20 - 40$ sec.

Peak temp.: 260°C

Hand Soldering condition:

The Soldering iron tip should be less than 300°C and maximum contact time should be 5 seconds.

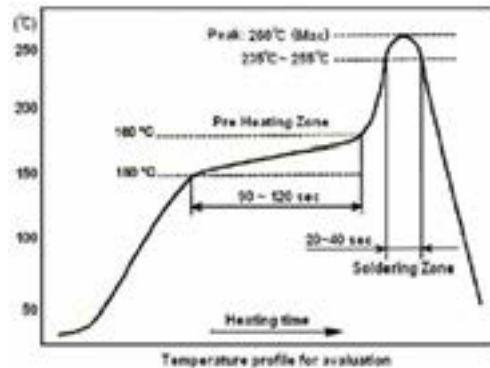

RECOMMENDED PCB LAYOUT PLAN

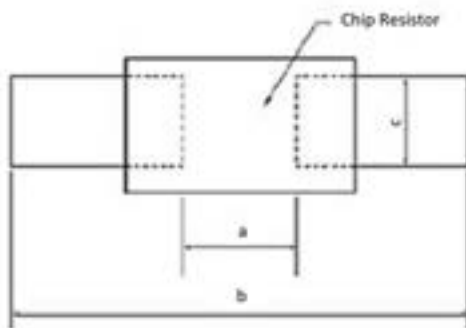

Type	a (mm)	b (mm)	c (mm)
0402	0.45 to 0.55	1.35 to 1.45	0.45 to 0.55
0603	0.85 to 0.95	2.05 to 2.15	0.75 to 0.85
0805	0.90 to 1.10	2.90 to 3.10	1.20 to 1.40
1206	1.90 to 2.10	4.10 to 4.30	1.50 to 1.70
1210	1.90 to 2.10	4.10 to 4.30	2.50 to 2.70
2010	3.50 to 3.70	6.10 to 6.30	2.50 to 2.70
2512	4.90 to 5.10	8.10 to 8.30	3.20 to 3.40

ORDERING INFORMATION

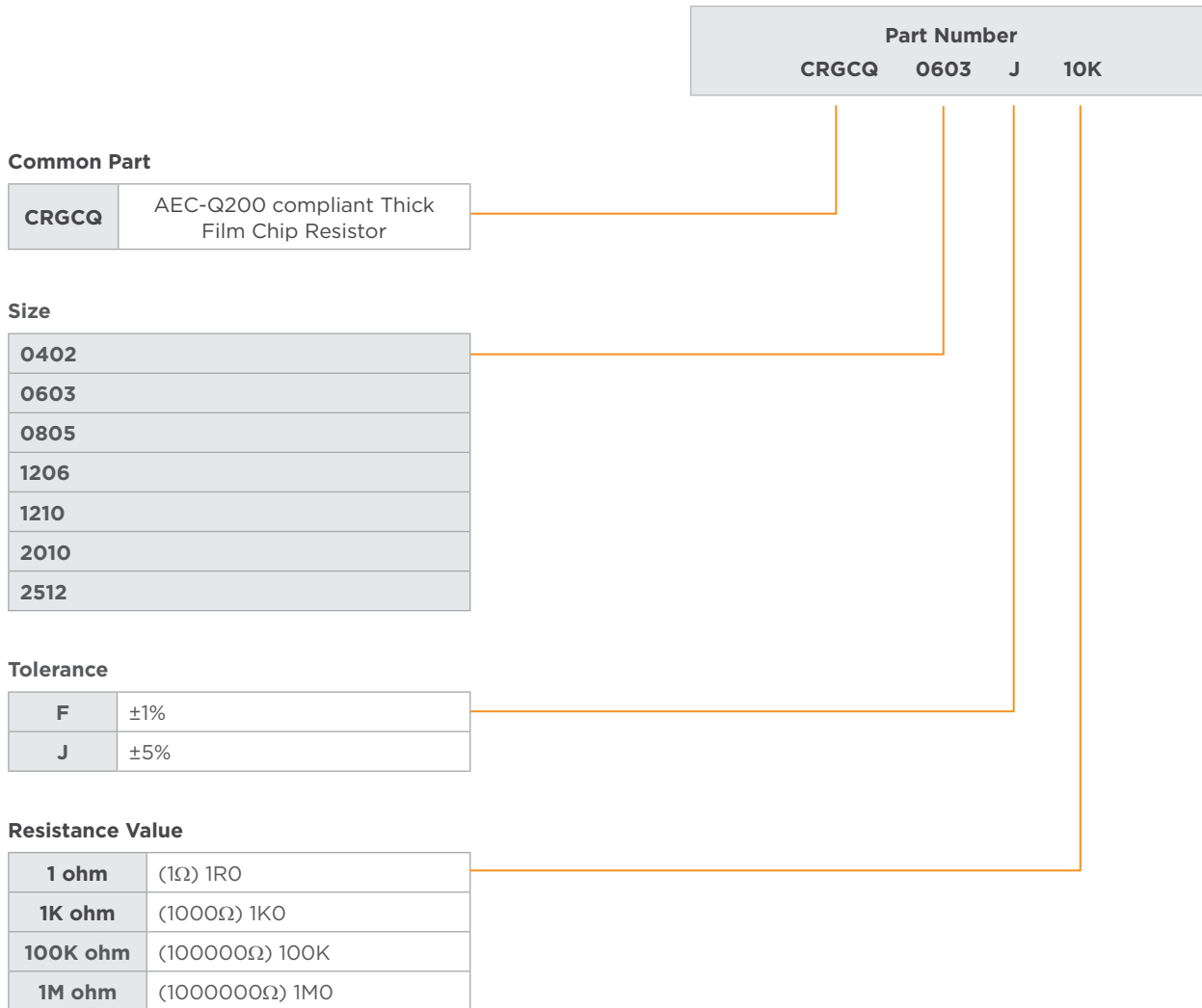

te.com

©2023 TE Connectivity. All Rights Reserved.

TE Connectivity, TE connectivity (logo) and Every Connection Counts are trademarks. All other logos, products and/or company names referred to herein might be trademarks of their respective owners.

While TE has made every reasonable effort to ensure the accuracy of the information in this document, TE does not guarantee that it is error-free, nor does TE make any other representation, warranty or guarantee that the information is accurate, correct, reliable or current. TE reserves the right to make any changes to the information contained herein without prior notice. TE Connectivity assumes only those obligations set forth in the terms and conditions for this product and shall in no event be liable for any incidental, indirect, or consequential damages arising out of the sale, resale, use, or misapplication of the product. TE expressly disclaims any implied warranties with respect to the information contained herein, including, but not limited to, implied warranties of merchantability or fitness for a particular purpose. Dimensions, specifications and/or information contained herein are for reference purposes only and are subject to change without notice. Consult TE for the latest dimensions, specifications and/or information. Users of TE Connectivity products must make their own assessment as to whether the respective product is suitable for the respective desired application.

1773204-3 Rev B 09/23

ED