

SMD THIN FILM PRECISION RESISTORS - AEC-Q200 COMPLIANT

TYPE RQ73 SERIES

INTRODUCTION

TE Connectivity (TE) is proud to introduce this automotive grade thin film precision chip resistor, a sister to our highly successful RN73 range. The resistors are constructed in a high grade raw materials and laser trimmed to give precise tolerance figures. This, coupled with the tight TCR and anti-corrosive protection layer gives us a range of resistors which are ideal not just for automotive applications, but also for medical equipment, measuring instruments and industrial applications.

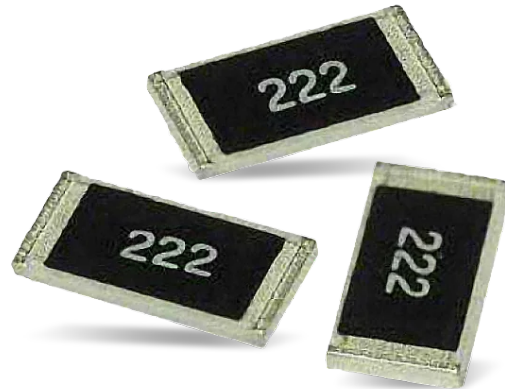

FEATURES

- SMD TaN thin film resistor
- Special passivation layer on resistive element
- AEC-Q200 qualified
- Sulfur resistant
- RoHS Compliant

CHARACTERISTICS - ELECTRICAL

Type	RQ73 1E	RQ73 1J	RQ73 2A	RQ73 2B
Size	0402	0603	0805	1206
Resistance tolerance	±0.05%, ±0.1%			
Resistance Range	40R - 35K	40R - 130K	10R - 350K	10R -1M0
TCR (ppm/°C)	±10PPM/°C			
Power rating @ 85°C	0.0625 W	0.166 W	0.2 W	0.5 W
Max. Working Voltage (DC or RMS) ^{1 2}	50 V	75 V	100 V	200 V
Max. Overload Voltage (DC or RMS)	100 V	150 V	200 V	400 V
Operating Temperature	-55 °C ~ 155 °C			

Notes:

1. This is the maximum voltage that may be continuously supplied to the resistor element, see "IEC publication 60115-8"
2. Max. Operation Voltage : So called RCWV (Rated Continuous Working Voltage) is determined by $RCWV = \sqrt{\text{Rated Power} \times \text{Resistance Value}}$ or Max. RCWV listed above, whichever is lower.

SMD Thin Film Precision Resistors - AEC-Q200 Compliant

Type RQ73 series

CONSTRUCTION

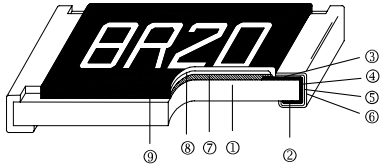

① Alumina Substrate	④ Edge Electrode	⑦ Resistor Layer
② Bottom Electrode	⑤ Barrier Layer	⑧ Overcoat
③ Top Electrode	⑥ External Electrode	⑨ Marking

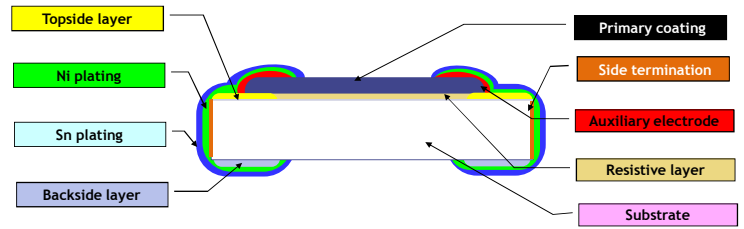

DIMENSIONS (Unit:mm)

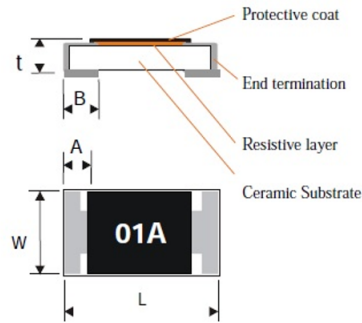

Type	RQ73 1E	RQ73 1J	RQ73 2A	RQ73 2B
L	1.00 ± 0.05	1.55 ± 0.10	2.00 ± 0.15	3.05 ± 0.15
W	0.50 ± 0.05	0.80 ± 0.10	1.25 ± 0.15	1.55 ± 0.15
A	0.20 ± 0.10	0.30 ± 0.20	0.30 ± 0.20	0.42 ± 0.20
B	0.20 ± 0.10	0.30 ± 0.20	0.40 ± 0.20	0.35 ± 0.25
t	0.30 ± 0.05	0.45 ± 0.10	0.55 ± 0.10	0.55 ± 0.10

RECOMMENDED LAND PATTERN

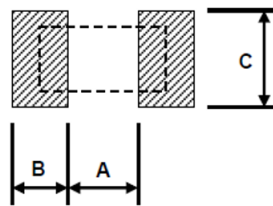

Type	RQ73 1E	RQ73 1J	RQ73 2A	RQ73 2B
A	0.50	0.80	1.00	2.00
B	0.50	1.00	1.00	1.15
C	0.60 ± 0.2	0.90 ± 0.2	1.35 ± 0.2	1.70 ± 0.2

SMD Thin Film Precision Resistors - AEC-Q200 Compliant

Type RQ73 series

DERATING CURVE

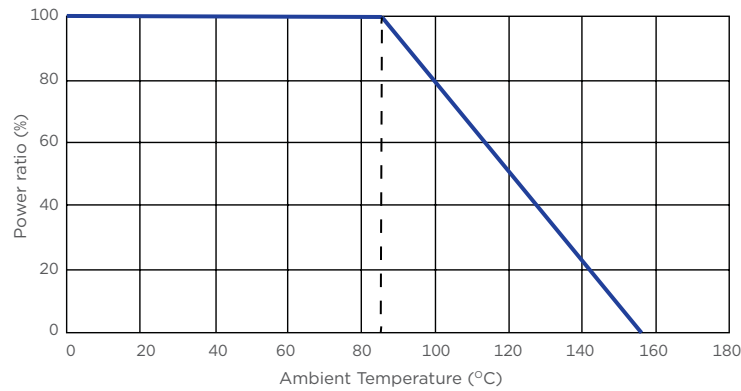

SINGLE PULSE

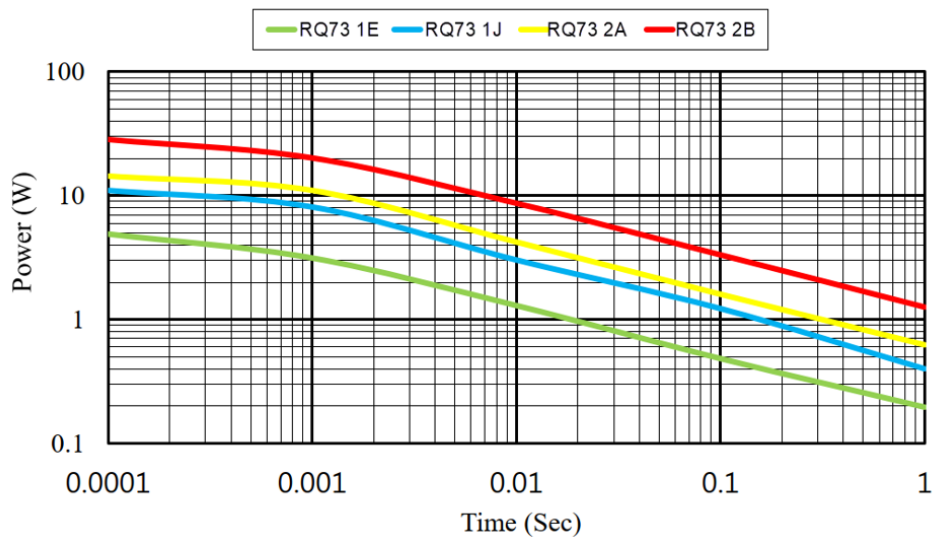

CONTINUOUS PULSE

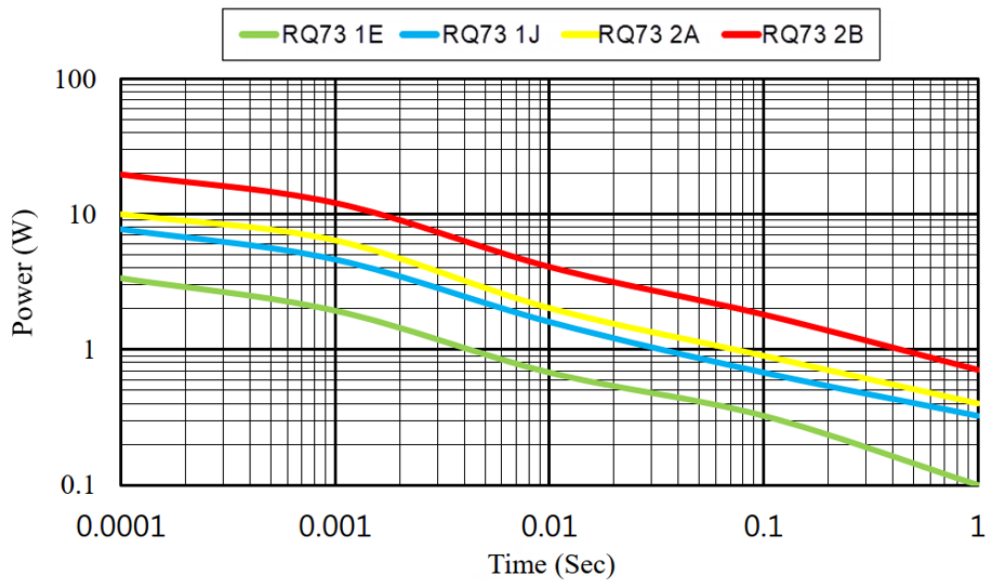

SMD Thin Film Precision Resistors - AEC-Q200 Compliant

Type RQ73 series

ENVIRONMENTAL CHARACTERISTICS

Test	Procedure	Requirement
Temperature Coefficient of Resistance (T.C.R.)	JIS-C-5201-1 4.8 IEC-60115-1 4.8 -55 °C ~ +125 °C, 25 °C is the reference temperature	As Spec.
Short time overload	JIS-C-5201-1 4.13 RCWV*2.5 or Max. overload voltage whichever is lower for 5 seconds	$\Delta R \pm 0.1\%$
Insulation resistance	JIS-C-5201-1 4.6 IEC-60115-1 4.6 Apply 100 VDC for 1 minute	>1000 M Ω
Resistance to soldering heat	JIS-C-5201-1 4.18 IEC-60115-1 4.18 260 \pm 5 °C for 10 seconds	$\Delta R \pm 0.1\%$
Solderability	JIS-C-5201-1 4.17 IEC-60115-1 4.17 245 \pm 5 °C for 3 seconds	95% min. coverage
Temperature cycling	JESD22 Method JA-104 -55 °C to +125 °C, 1000 cycles -55 °C to +155 °C, 1000 cycles	$\Delta R \pm 0.1\%$ for 125 °C
		$\Delta R \pm 0.2\%$ for 155 °C
Bias humidity	MIL-STD-202 Method 103 1000 hrs 85 °C / 85% RH 10% of operating power.	$\Delta R \pm 0.1\%$
Load life	IEC60115-1 4.25 1000 +48/-0 hours, loaded with RCWV or Vmax in chamber controller 85 \pm 2 °C, 1.5 hours on and 0.5 hours off	$\Delta R \pm 0.1\%$
Operational life	MIL-STD-202 Method 108 Condition D Steady State TA = 125 °C at derated power. Measurement at 24 \pm 4 hours after test conclusion.	$\Delta R \pm 0.1\%$
High temperature exposure	MIL-STD-202 Method 108 at +155 °C for 1000 hrs	$\Delta R \pm 0.15\%$
Moisture resistance	MIL-STD-202 Method 106 65 \pm 2°C, 80-100% RH, 10 cycles, 24 hours/cycle	$\Delta R \pm 0.1\%$
Mechanical shock	MIL-STD-202 Method 213 Wave Form: Tolerance for half sine shock pulse. Peak value is 100 g's. Normal duration(D) is 6.	$\Delta R \pm 0.1\%$
Vibration	MIL-STD-202 Method 204 5 g's for 20 min., 12 cycles each of 3 orientations, 10-2000 Hz	$\Delta R \pm 0.1\%$
Terminal strength	AEC-Q200-006 Force of 1 kg for 60 seconds.	No Damage
Board flex	JIS-C-5201-1 4.33 Bending 2 mm for 60 seconds	$\Delta R \pm 0.1\%$
ESD	AEC-Q200-002 Human body model RQ0402, RQ0603 0.2KV classification level 1A RQ0805, RQ1206 1KV classification level 1C	$\Delta R \pm 0.1\%$
Resistance to solvents	MIL-STD-202 Method 215 Add Aqueous wash chemical - OKEM Clean or equivalent. Do not use banned solvents.	Marking unsmeared

SMD Thin Film Precision Resistors - AEC-Q200 Compliant

Type RQ73 series

ENVIRONMENTAL CHARACTERISTICS

Test	Procedure	Requirement
Flammability	UL-94 V-0 or V-1 are acceptable. Electrical test not required.	No ignition of the tissue paper or scorching or the pinewood board
Sulfur test	ASTM-B-809-95 105 ±2 °C no power rating for 750 hrs	ΔR ±1%
Endurance	IEC60115-1 4.25 1000 = 48/-0 hours, loaded with RCWV or Vmax in chamber controller 85 ±2 °C, 1.5 hours on and 0.5 hours off	ΔR±0.1%

MARKING

0603 E24 series 3 Digits - first two digits denote significant figures of resistance and third digit denotes number of zeros thereafter.
EG

	222		=	2K2
--	-----	--	---	-----

0603 E96 series 3 Digits - The 1st two digit codes are referring to the CODE in the table, the 3rd code is the index of resistance value :

$$Y=10^{-2}, X=10^{-1}, A=10^0, B=10^1, C=10^2, D=10^3, E=10^4, F=10^5$$

$$EX : 17.8\Omega=25X, 178\Omega=25A, 1K78 =25B$$

$$17K8=25C, 178K=25D, 1M78=25E$$

Code	R_value	Code	R_value	Code	R_value	Code	R_value	Code	R_value	Code	R_value	Code	R_value	Code	R_value
1	100	13	133	25	178	37	237	49	316	61	422	73	562	85	750
2	102	14	137	26	182	38	243	50	324	62	432	74	576	86	768
3	105	15	140	27	187	39	249	51	332	63	442	75	590	87	787
4	107	16	143	28	191	40	255	52	340	64	453	76	604	88	806
5	110	17	147	29	196	41	261	53	34B	65	464	77	619	89	825
6	113	18	150	30	200	42	267	54	357	66	475	78	634	90	845
7	115	19	154	31	205	43	274	55	365	67	487	79	649	91	866
8	118	20	158	32	210	44	280	56	374	68	499	80	665	92	887
9	121	21	162	33	215	45	287	57	383	69	511	81	681	93	909
10	124	22	165	34	221	46	294	58	392	70	523	82	698	94	931
11	127	23	169	35	226	47	301	59	402	71	536	83	715	95	953
12	130	24	174	36	232	48	309	60	412	72	549	84	732	96	976

0805 & 1206 E24 and E96 4 digits - Where value is below 100R use R as decimal, otherwise three significant figures plus number of following zeros.

EG:

Resistance	10Ω	12Ω	100Ω	6K8	47K
4 digit marking	10R0	12R0	1000	6801	4702

Notes:

1. No marking for non-E24/E96 resistance values.
2. No marking for 0402 size resistors

SMD Thin Film Precision Resistors - AEC-Q200 Compliant

Type RQ73 series

PACKAGING

Reel Dimensions (mm)

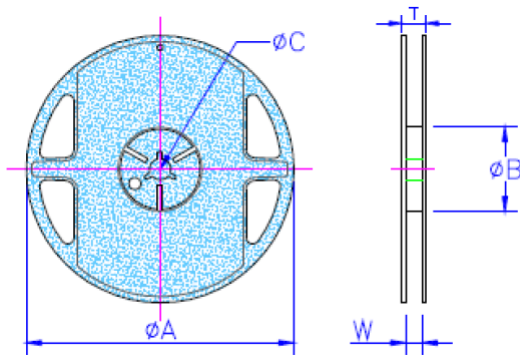

ØA	ØB	ØC	W	T	QTY
178.0 ±1.0	60.0 +1.0	13.5 ±0.7	9.5 ±1.0	11.5 ±1.0	1000 / 5000

Paper Tape Specification (mm)

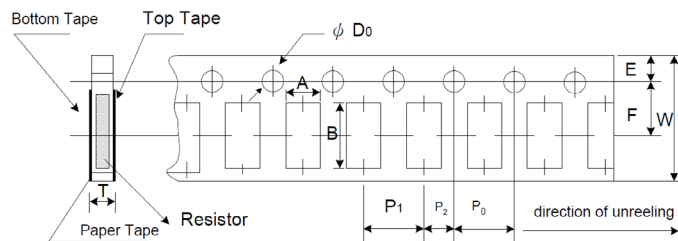

	A	B	W	E	F	P ₀	P ₁	P ₂	ØD ₀	T
0402	0.70 ±0.05	1.16 ±0.05	8.00 ±0.10	1.75 ±0.05	3.5 ±0.05	4.00 ±0.10	2.00 ±0.05	2.00 ±0.05	1.55 ±0.05	0.40 ±0.03
0603	1.10 ±0.05	1.90 ±0.05	8.00 ±0.10	1.75 ±0.05	3.5 ±0.05	4.00 ±0.10	4.00 ±0.10	2.00 ±0.05	1.55 ±0.05	0.60 ±0.03
0805	1.60 ±0.05	2.37 ±0.05	8.00 ±0.10	1.75 ±0.05	3.5 ±0.05	4.00 ±0.10	4.00 ±0.10	2.00 ±0.05	1.55 ±0.05	0.75 ±0.05
1206	2.00 ±0.05	3.55 ±0.05	8.00 ±0.10	1.75 ±0.05	3.5 ±0.05	4.00 ±0.10	4.00 ±0.10	2.00 ±0.05	1.55 ±0.05	0.75 ±0.05

- Peel force of top cover tape
- The peel speed shall be about 300 mm/min ±5 %
- The peel force of top cover tape shall be between 8 gf to 60 gf

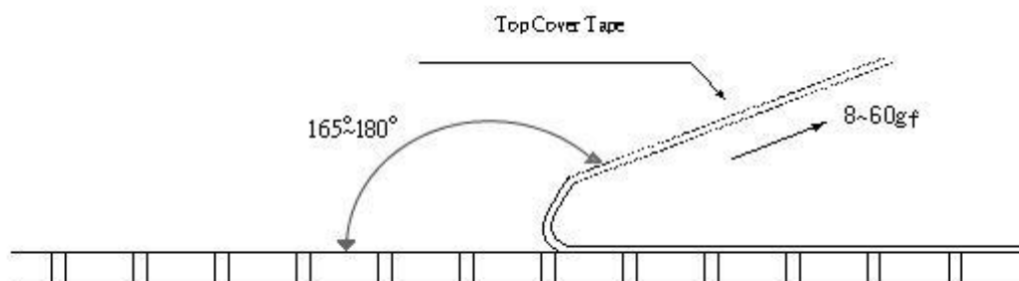

SMD Thin Film Precision Resistors - AEC-Q200 Compliant

Type RQ73 series

STORAGE AND HANDLING CONDITION: MSL 1

1. Products are recommended to be used up within two years of manufacturing date. Check solderability in case shelf life extension is needed.
2. To store products with following condition: Temperature : 15 °C ~ 28 °C Humidity : < 80% relative humidity
3. Caution:
 - a. Don't store products in a corrosive environment such as sulfide, chloride gas, or acid. It may cause oxidation of electrode, which easily be resulted in poor soldering.
 - b. To store products on the shelf and avoid exposure to moisture.
 - c. Don't expose products to excessive shock, vibration, direct sunlight etc.

SOLDERING PROFILE

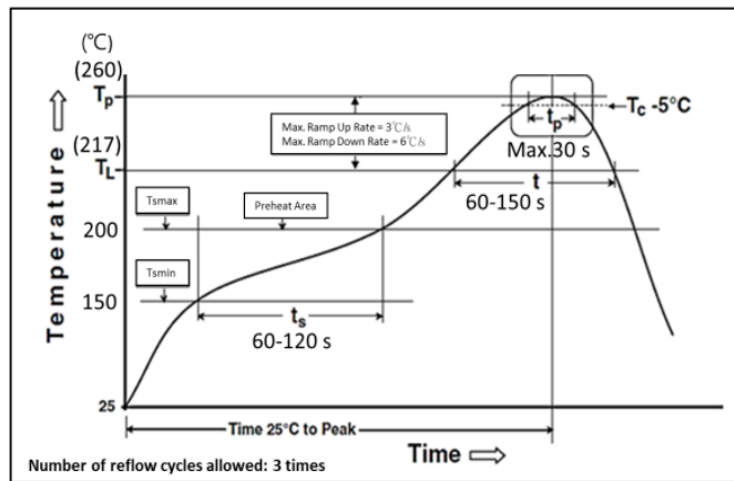

Reflow Profiles	
Profile Feature	Pb-Free Assembly
Preheat	
Min. Temperature (T_s min)	150 °C
Max. Temperature (T_s max)	200 °C
Preheating time (t_s) from (T_s min to T_s max)	60 seconds - 120 seconds
Ramp-up rate (T_L to T_p)	3 °C/second max.
Liquidous temperature (T_L)	217 °C
Time (T_L) maintained above T_L	60 seconds - 150 seconds
Min. Peak temperature (T_p min)	235 °C
Max. Peak temperature (T_p max)	260 °C
Time (t_p) within 5°C of the specified classification temperature (T_c)	30 seconds max.
Ramp-down rate (T_p to T_L)	6 °C/seconds max.
Time 25°C to peak temperature	8 minutes max.

ORDERING INFORMATION

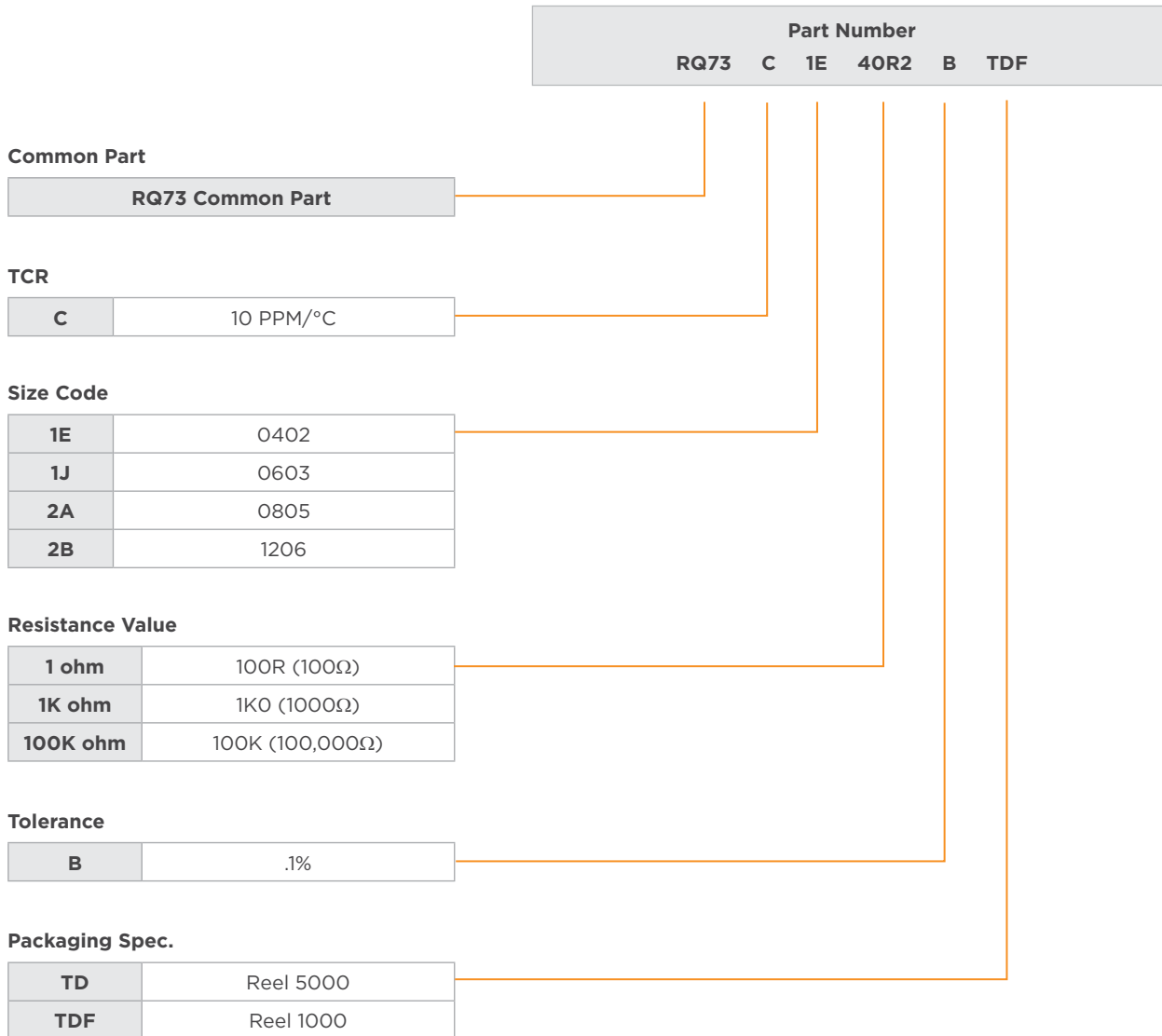

[te.com](https://www.te.com)

©2023 TE Connectivity. All Rights Reserved.

TE Connectivity, TE connectivity (logo) and Every Connection Counts are trademarks. All other logos, products and/or company names referred to herein might be trademarks of their respective owners.

While TE has made every reasonable effort to ensure the accuracy of the information in this document, TE does not guarantee that it is error-free, nor does TE make any other representation, warranty or guarantee that the information is accurate, correct, reliable or current. TE reserves the right to make any changes to the information contained herein without prior notice. TE Connectivity assumes only those obligations set forth in the terms and conditions for this product and shall in no event be liable for any incidental, indirect, or consequential damages arising out of the sale, resale, use, or misapplication of the product. TE expressly disclaims any implied warranties with respect to the information contained herein, including, but not limited to, implied warranties of merchantability or fitness for a particular purpose. Dimensions, specifications and/or information contained herein are for reference purposes only and are subject to change without notice. Consult TE for the latest dimensions, specifications and/or information. Users of TE Connectivity products must make their own assessment as to whether the respective product is suitable for the respective desired application.

1773270-2 Rev B2 10/23 ED